

QUICK START GUIDE



Nugget Ice Machine

- ADA, 1 & 3 Class

WELCOME TO U-LINE

Congratulations on your U-Line purchase. Your product comes from a company with over five decades of premium modular ice making, refrigeration, and wine preservation experience. U-Line continues to be the American leader, delivering versatility and flexibility for multiple applications including residential, light commercial, outdoor and marine use. U-Line's complete product collection includes Wine Captain® Models, Beverage Centers, Clear Ice Machines, Nugget Ice Machines, Crescent Ice Makers, Glass & Solid Door Refrigerators, Drawer Models, Freezers, Combo® Models, and more.

U-Line has captivated those with an appreciation for the finer things with exceptional functionality, style, inspired innovations and attention to even the smallest details. We are known and respected for our unwavering dedication to product design, quality and selection. U-Line is headquartered in Milwaukee, Wisconsin and has shipped product to five continents for over two decades and is proud to have the opportunity to ship to you.

PRODUCT INFORMATION

Looking for additional information on your product? User Guides, Spec Sheets, CAD Drawings, Compliance Documentation, and Product Warranty information are all available for reference and download at u-line.com.

PROPERTY DAMAGE / INJURY CONCERNS

In the unlikely event property damage or personal injury is suspected related to a U-Line product, please take the following steps:

1. U-Line Customer Care must be contacted immediately at +1.800.779.2547.
2. Service or repairs performed on the unit without prior written approval from U-Line is not permitted. If the unit has been altered or repaired in the field without prior written approval from U-Line, claims will not be eligible.

GENERAL INQUIRIES

U-Line Corporation
8900 N. 55th Street
Milwaukee, Wisconsin 53223 USA
Monday - Friday 8:00 am to 4:30 pm CST
T: +1.414.354.0300
F: +1.414.354.7905
Email: sales@u-line.com
u-line.com

SERVICE & PARTS ASSISTANCE

Monday - Friday 8:00 am to 4:30 pm CST
T: +1.800.779.2547
F: +1.414.354.5696
Service Email: onlineservice@u-line.com
Parts Email: onlineparts@u-line.com

CONNECT WITH US



Designed, engineered and assembled in WI, USA

This Quick Start Guide covers the basics of installation and general use of your product.

CONTENTS

Safety and Warning	4
Environmental Requirements	5
Electrical	5
Water Hookup	6
Drain	8
Door Swing	9
Door Adjustments	11
General Installation	13
Integrated Panel Installation	14
Control Operation	15
First Use	18
Ice	18
Cleaning	18
Warranty	20

For more details, see the complete User Guide & Service Manual on u-line.com.



This product is eligible for an additional one-year warranty at no charge when you register your product on u-line.com. See complete warranty for details.

Safety and Warning

Please read all instructions before installing, operating, or servicing the appliance.

Use this appliance for its intended purpose only and follow these general precautions with those listed throughout this guide:

SAFETY ALERT DEFINITIONS

Throughout this guide are safety items labeled with a Danger, Warning or Caution based on the risk type:



DANGER

Danger means that failure to follow this safety statement will result in severe personal injury or death.



WARNING

Warning means that failure to follow this safety statement could result in serious personal injury or death.



CAUTION

Caution means that failure to follow this safety statement may result in minor or moderate personal injury, property or equipment damage.



DANGER

Your product may contain R600a (Isobutane) which is a flammable hydrocarbon. To confirm, check serial tag inside unit. It is safe for regular use. Do not use sharp objects to expedite defrosting. Do not service without consulting the “R600a specifications” section included in the User Guide. Do not damage the refrigerant circuit.



WARNING

Service must be done by factory authorized service personnel. Any parts shall be replaced with like components. Failure to comply could increase the risk of possible ignition due to incorrect parts or improper service.

CALIFORNIA PROPOSITION 65

This product contains chemicals known to the state of California to cause cancer and birth defects or other reproductive harm.

www.P65warnings.CA.gov

Environmental Requirements

This model is intended for indoor/interior applications only and is not to be used in installations that are open/exposed to natural elements.

This unit is designed to operate between 50°F (10°C) and 100°F (38°C). Higher ambient temperatures may reduce the unit's ability to reach low temperatures and/or reduce ice production on applicable models.

For best performance, keep the unit out of direct sunlight and away from heat generating equipment.

In climates where high humidity and dew points are present, condensation may appear on outside surfaces. This is considered normal. The condensation will evaporate when the humidity drops.



CAUTION

Damages caused by ambient temperatures of 40°F (4°C) or below are not covered by the warranty.

Electrical



WARNING

SHOCK HAZARD – Electrical Grounding Required. Never attempt to repair or perform maintenance on the unit until the electricity has been disconnected.

Never remove the round grounding prong from the plug and never use a two-prong grounding adapter.

Altering, cutting or removing power cord, removing power plug, or direct wiring can cause serious injury, fire, loss of property and/or life, and will void the warranty.

Never use an extension cord to connect power to the unit.

Always keep your working area dry.

Electrical installation must observe all state and local codes. This unit requires connection to a grounded (three-prong), polarized receptacle that has been placed by a qualified electrician.

The unit requires a grounded and polarized 115 VAC, 60 Hz, 15A power supply (normal household current). An individual, properly grounded branch circuit or circuit breaker is recommended. A GFCI (ground fault circuit interrupter) is usually not required for fixed location appliances and is not recommended for your unit because it could be prone to nuisance tripping. However, be sure to consult your local codes.

Water Hookup

PREPARE PLUMBING

The water valve uses a standard 1/4" (6.35 mm) compression fitting. U-Line recommends using accessory water hook up kit – part # 80-54674-00. The kit includes a 10' (3 m) braided flexible water supply line and a brass hose fitting.



CAUTION

Plumbing installation must observe all state and local codes. All water and drain connections MUST BE made by a licensed/qualified plumbing contractor. Failure to follow recommendations and instructions may result in damage and/or harm.

Water Supply Connection

When connecting the water supply, please note the following:

- Before installing the unit and connecting to the cold water supply, review the local plumbing codes.
- The water pressure should be between 20 and 120 psi (138 and 827 kPa).
- The water line MUST have a shut-off valve in the supply line.
- The water line should be looped into 2 coils. This will allow the unit to be removed for cleaning and servicing. Make certain that the tubing is not pinched or damaged during installation.



WARNING

Connect to potable water supply only.



CAUTION

Do not use any plastic water supply line. The line is under pressure at all times. Plastic may crack or rupture with age and cause damage to your home.

Do not use tape or joint compound when attaching a braided flexible water supply line that includes a rubber gasket. The gasket provides an adequate seal – other materials could cause blockage of the valve.

Failure to follow recommendations and instructions may result in damage and/or harm, flooding or void the product warranty.

Use new hose set. Do not reuse old hose set.



CAUTION

Turn off water supply and disconnect electrical supply to unit prior to installation.

Use caution when handling back panel. The edges could be sharp..

1. Remove the back panel. Turn off water supply and disconnect electrical supply to product prior to attempting installation.
2. Remove the back panel.

3. Thread water line through back panel hole (with bushing).

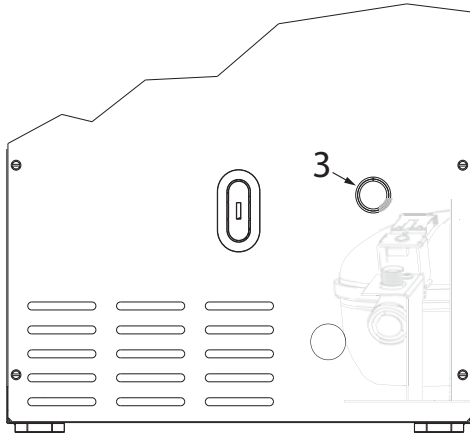

4. Locate water valve inlet and connect to valve.

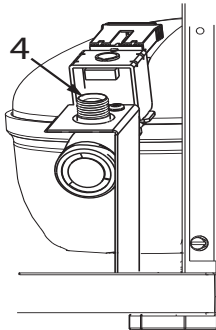

5. Turn on water supply and check for leaks.

6. Reinstall back panel.

Drain

Model numbers including "CL" or "NB" do not include a factory installed drain pump.

Model numbers including "CP" or "NP" include a factory installed drain pump.

DRAIN CONNECTION



If your U-Line unit did not come with a factory installed drain pump you must use a gravity style drain connection. For assistance in determining if your unit has a pump please contact U-Line. The floor drain must be large enough to accommodate drainage from all attached drains. Follow these guidelines when installing drain lines to prevent water from flowing back into the ice maker storage bin and/or potentially flowing onto the floor, which may result in personal injury or property damage.

Drain can NOT be located directly below the unit. Unit has a solid base that will not allow the unit to drain below itself.

There is a possibility that hose connections may have loosened during shipment.

Verify all connections and fittings are free from leaks.

GRAVITY DRAIN

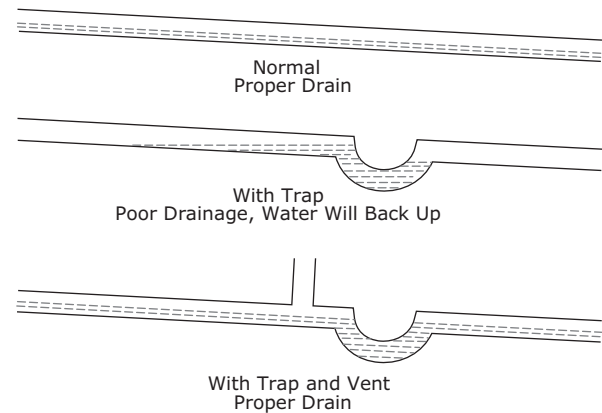

A gravity drain may be used if:

Drain line has at least a 1" drop per 48" (approximately 2 cm drop per 100 cm) of run.

Drain line does not create traps and is vented per local code.

1. Cut the pre-installed drain tube to length.
2. Connect to your local plumbing per the local code.
3. If necessary, insulate drain line to prevent condensation.



Failure to connect water supply or drain line connections properly can result in personal injury and property damage. Gravity drain connections must be routed downward from the rest of the unit at the rate of 1/4" per foot (1 cm per 50 cm).

FACTORY INSTALLED DRAIN PUMP

If your drain line will run up to a stand pipe, disposal or spigot assembly, or does not otherwise meet the requirements for a gravity drain, you may have ordered a pre-installed U-Line P60 drain pump.

If you need to install a P60 drain pump into your unit, see DRAIN PUMP section in the User Manual.

See below for typical installations requiring a drain pump.

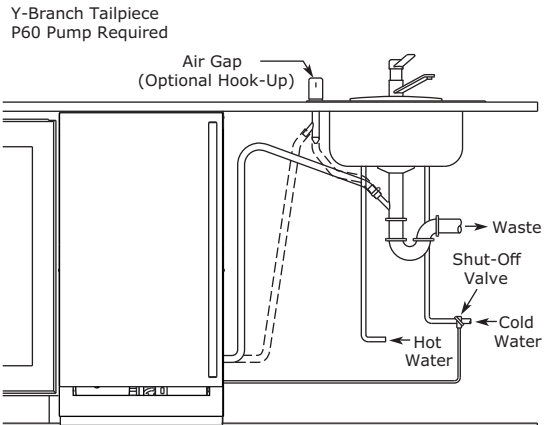

The maximum lift for the P60 drain pump is 10 feet. This must be done as close to the rear of the unit as possible.

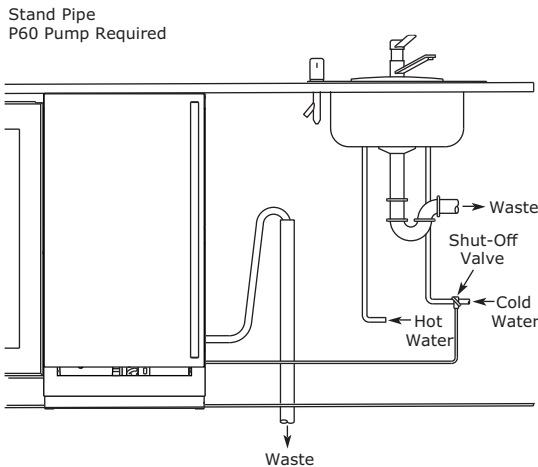

Door Swing

1/2" (13 mm) clearance is recommended from wall on hinge side to allow the door to open 90°. Allow for additional space for any knobs or pulls installed on the integrated panel/frame.

Stainless Steel models that are installed adjacent to a wall require 2-1/4" (57 mm) door clearance on hinge side to allow for door handle.

Units have a zero clearance when installed adjacent to cabinets.

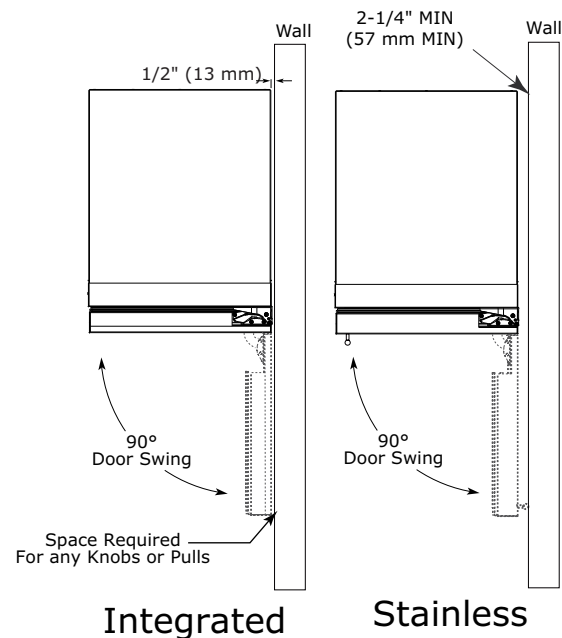
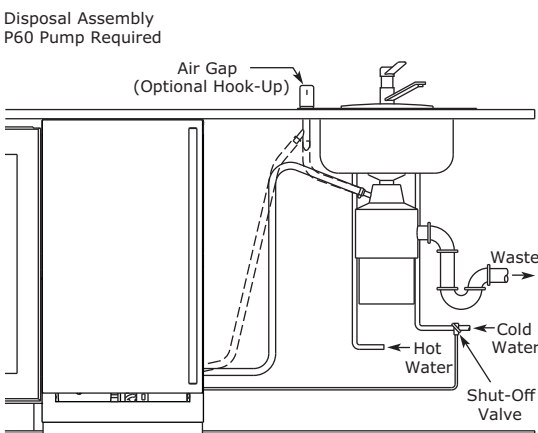

Door Adjustments

1 CLASS AND 3 CLASS

DOOR ALIGNMENT AND ADJUSTMENT

Align and adjust the door if it is not level or is not sealing properly. If the door is not sealed, the unit may not cool properly, or excessive frost or condensation may form in the interior.

Properly aligned, the door's gasket should be firmly in contact with the cabinet all the way around the door (no gaps). Carefully examine the door's gasket to ensure that it is firmly in contact with the cabinet. Also make sure the door gasket is not pinched on the hinge side of the door.



Do not attempt to use the door to raise or pivot your unit. This would put excessive stress on the hinge system.

Alignment and Adjustment Procedure

1. Open door and remove gasket near the hinges.
2. Using a T-25 Torx Bit, loosen each pair of Torx head screws on both the upper and lower hinge plates.
3. Square and align door as necessary.
4. Tighten Torx head screws on hinge.
5. Reinstall gasket into the channel starting at the corner.

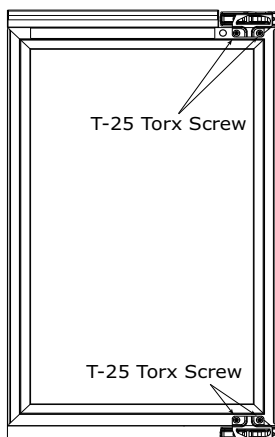

REVERSING THE DOOR

1. Open door.
2. Using T-25 Torx bit loosen screw #1 and remove screw #2 on top and bottom hinge. Slide and remove the door from unit. Completely remove screw #1 on top and bottom.

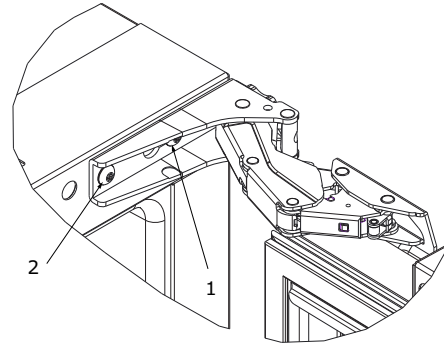

3. Remove caps from screw heads on opposite side (2 on top and 2 on bottom). Using #2 Phillips bit remove the 4 underlying screws. Reinstall the screws and caps on the opposite side.

Note: One hinge includes a metal spacer. Spacer must be used with that hinge when reversing the door.

4. Partially install screw #1 in the outer most holes on top and bottom. Rotate door 180°, align hinge over screw #1 and slide/seat into position. Reinstall screw #2 on top and bottom. Tighten both screws and install hinge cover.

Align and adjust the door:

Align and adjust the door (see DOOR ALIGNMENT AND ADJUSTMENT).

Door Adjustments

ADA COLLECTION

HINGE COVER

Hinge cover included with the literature bag is optional.

To install hinge cover:

1. Press hinge cover squarely over hinge.

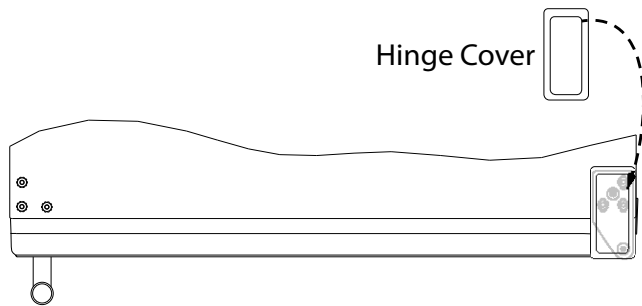

DOOR ALIGNMENT AND ADJUSTMENT

Align and adjust the door if it is not level or is not sealing properly. If the door is not sealed, the unit may not cool properly, or excessive frost may form in the interior.

Properly aligned, the door's gasket should be firmly in contact with the cabinet all the way around the door (no gaps). Carefully examine the door's gasket to ensure that it is firmly in contact with the cabinet. Also make sure the door gasket is not pinched on the hinge side of the door.

To align and adjust the door:

1. Gently pry off hinge cover from top of unit.
2. Loosen (do not remove) top and bottom hinge screws using a Torx T-25 screwdriver.
3. Align door squarely with cabinet.
4. Make sure gasket is firmly in contact with cabinet all the way around the door (no gaps).
5. Tighten bottom hinge screws.

6. Tighten top hinge screws and replace hinge cover.

TO REVERSE THE DOOR

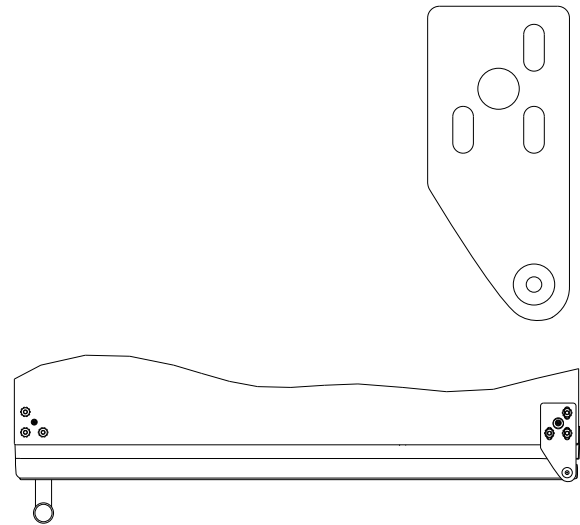

Remove top hinge and door:

1. Hold door to keep it from falling.
2. Remove top hinge from cabinet using a Torx T-25 screwdriver to remove three screws. Set aside and save.

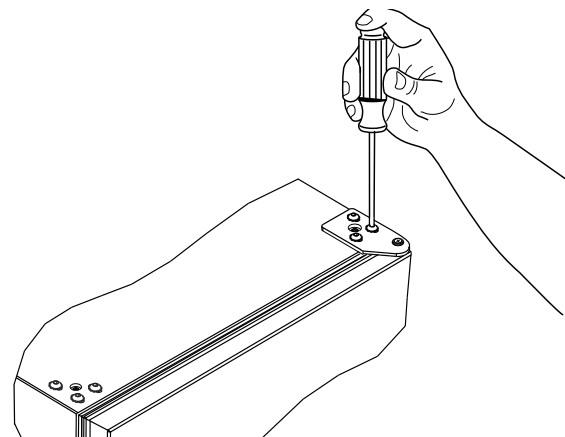

3. Remove door by tilting forward and lifting door off bottom hinge. Retain shoulder washers; they will be reused.

4. Remove three screws from hinge holes on the opposite side. Reinstall into holes where the hinge was removed.

Remove bottom hinge:

1. Remove bottom hinge from cabinet using a T-10 TORX screw driver to remove three screws.

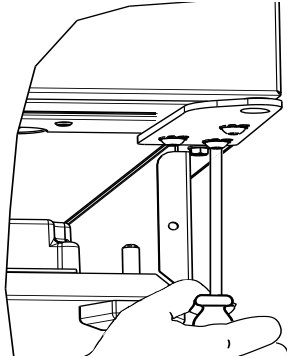

2. Remove corresponding screws on opposite side of cabinet. On some models there may be a nut behind one or both screws on either side.

Install bottom hinge:

Install two or three screws, depending on model. Replace nuts if used.

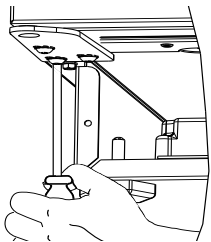

Prepare door for reinstallation:

1. Remove gasket. This will reveal mounting holes for the magnet assembly.
2. Remove magnet assembly from door with T-10 TORX driver. Be sure to only remove the two screws holding the assembly to the door. Reinstall on the opposite end of the door.
3. Rotate gasket 180°, aligning notch with magnet assembly and pressing firmly into the gasket channel starting at the corners.
4. Rotate door 180° to reverse.

Install top hinge and door:

1. Install hinge with longer straight edge aligned to outside edge of cabinet. Do not tighten.

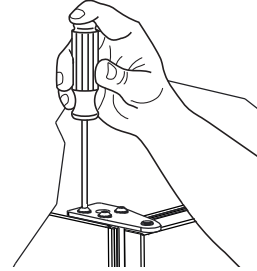

2. Lift the door on to the bottom hinge.
3. Align edge of the hinge with the outer edge of the unit.
4. Tighten three hinge screws.

Align and adjust the door:

Align and adjust the door (see DOOR ALIGNMENT AND ADJUSTMENT).

General Installation

LEVELING INFORMATION

1. Use a level to confirm the unit is level. Level should be placed along top edge and side edge as shown.

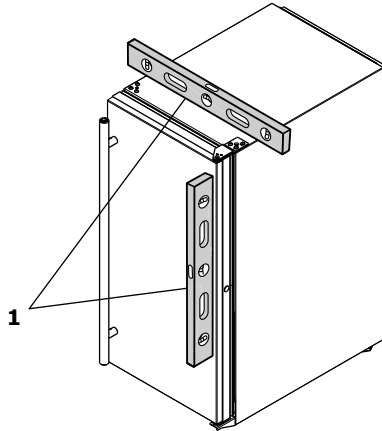

2. If the unit is not level, adjust the legs on the corners of the unit as necessary.

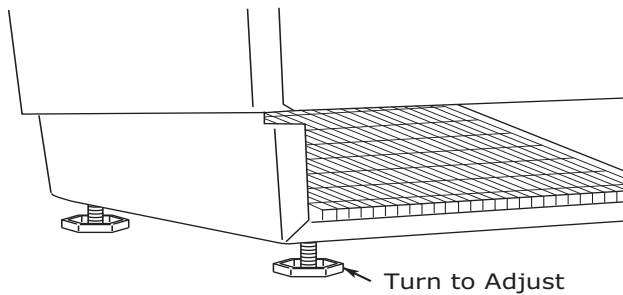

3. Confirm the unit is level after each adjustment and repeat the previous steps until the unit is level.

INSTALLATION TIP

If the room floor is higher than the floor in the cutout opening, adjust the rear legs to achieve a total unit rear height of 1/8" (3 mm) less than the opening's rear height. Shorten the unit height in the front by adjusting the front legs. This allows the unit to be gently tipped into the opening. Readjust the front legs to level the unit after it is correctly positioned in the opening.

INSTALLATION

1. Plug in the power/electrical cord.
2. Gently push the unit into position. Be careful not to entangle the cord or water and drain lines, if applicable.
3. Re-check the leveling, from front to back and side to side. Make any necessary adjustments. The unit's top surface should be approximately 1/8" (3 mm) below the countertop.
4. Install the anti-tip bracket.
5. Remove interior packing material and wipe out the inside of the unit with a clean, water-dampened cloth.

Integrated Panel Installation

INTEGRATED MODELS ONLY

1. Fully open door.
2. Starting at corner, pull gasket away from door.
3. Continue to pull gasket free from gasket channel.

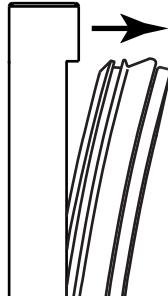

4. Upon removal, lay gasket down on a flat surface.
5. Align top of panel with top edge of door. Center panel on door.

Due to differences in floor construction or surrounding cabinetry, the panel may not sit flush with the top of the door.

6. Secure integrated panel to door using clamps. A robust tape may also be used. U-Line recommends the use of bar clamps to secure the panel to the door. If using tape, be certain the tape will not damage panel finish upon removal.

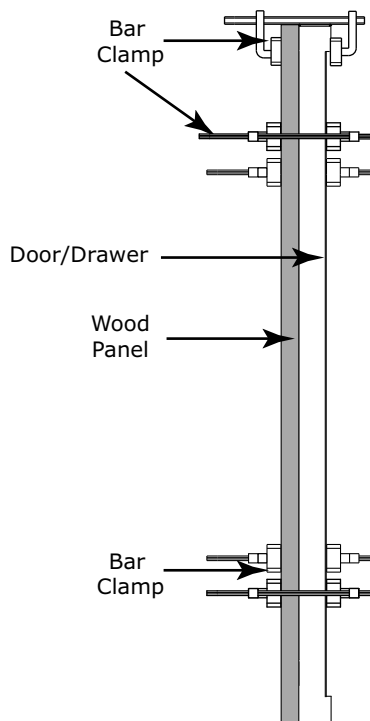

7. Using a 7/64" (3 mm) drill bit, drill 6 pilot holes into the wood panel 1/2" (12 mm) deep using the holes in the door frame as a guide.

It is important to ensure that all drilled holes are drilled to the correct depth in order to avoid splits in the wood when hardwood is installed.

8. Locate 6 of the #6x 1-1/2" (38 mm) screws provided with your unit.
9. Using a Phillips screwdriver, place one screw into each of the 6 pilot holes and screw down. Do not overtighten screws.
10. Ensure the screws sit flush against the bottom of the channel.

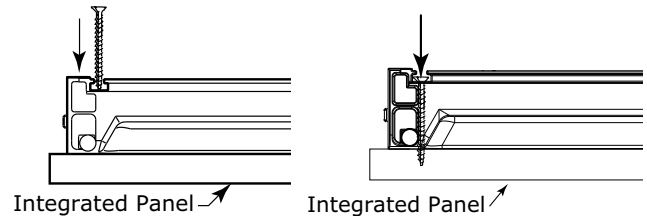

11. Remove clamps from door.

If panel requires additional adjustment after removing clamps, slightly loosen each screw and adjust panel as necessary. Tighten screws upon completion.



12. Starting at the corners, re-install the gasket into the gasket channel in the frame. Make sure the gasket is fully seated.

Control Operation

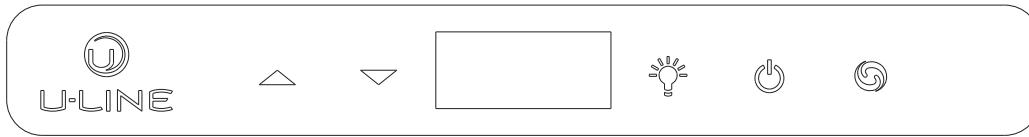
1 CLASS



CONTROL FUNCTION GUIDE

FUNCTION	COMMAND	NOTES
ON/OFF	Press  and release	Unit will immediately turn ON or OFF.
Enable Sabbath Mode	Press  and hold for 5 seconds and release.	The °F / °C symbol will flash briefly after 5 seconds. Interior light and display will go dark and remain so until user resets mode - unit continues to operate.
Disable Sabbath Mode	Press  and release.	Display and interior light return to normal operation.
Clean Mode	See "Cleaning" section	

This unit is Star-K certified. See www.star-k.org for more details.

DOOR ALERT NOTIFICATION

When the door is left open for more than 30 minutes:

- Ice production will cease
- A tone will sound for several seconds every minute
-  will appear in display







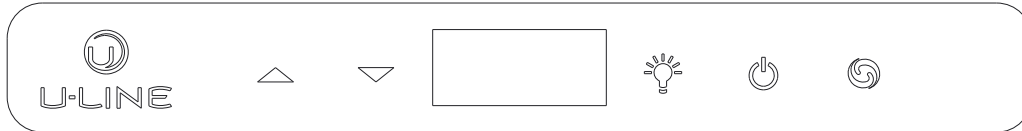







Close door to silence alert and reset (Ice production will resume if bin sensor is not satisfied)

Control Operation

3 CLASS



CONTROL FUNCTION GUIDE

FUNCTION	COMMAND	NOTES								
ON/OFF	Press  and release	Unit will immediately turn ON or OFF								
Adjust ice density	See "Ice" section									
Adjust light color	While holding  press and release  to scroll through lighting options	<table border="0"> <tr> <td>Option</td> <td>Open Door</td> </tr> <tr> <td></td> <td>White</td> </tr> <tr> <td></td> <td>Blue</td> </tr> <tr> <td></td> <td>White</td> </tr> </table>	Option	Open Door		White		Blue		White
Option	Open Door									
	White									
	Blue									
	White									
Enable Sabbath Mode	Press  and hold for 5 seconds and release	The °F / °C symbol will flash briefly after 5 seconds. Interior light and display will go dark and remain so until user resets mode - unit continues to operate								
Disable Sabbath Mode	Press  and release	Display and interior light return to normal operation								
Clean Mode	See "Cleaning" section									

This unit is Star-K certified. See www.star-k.org for more details.

DOOR ALERT NOTIFICATION

When the door is left open for more than 30 minutes:



- Ice production will cease
- A tone will sound for several seconds every minute
-  will appear in display

Close door to silence alert and reset (Ice production will resume if bin sensor is not satisfied)

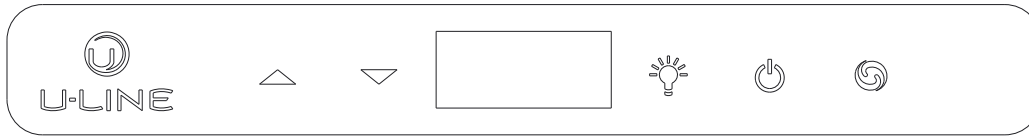
ADA COLLECTION



CONTROL FUNCTION GUIDE

FUNCTION	COMMAND	NOTES
ON/OFF	Press  and release	Unit will immediately turn ON or OFF.
Adjust ice density	See "Ice" Section	
Enable Sabbath Mode	Press  and hold for 5 seconds and release.	The °F / °C symbol will flash briefly after 5 seconds. Interior light and display will go dark and remain so until user resets mode - unit continues to operate.
Disable Sabbath Mode	Press  and release.	Display and interior light return to normal operation.
Clean Mode	See "Cleaning" section	

This unit is Star-K certified. See www.star-k.org for more details.

DOOR ALERT NOTIFICATION

When the door is left open for more than 30 minutes:



- Ice production will cease
- A tone will sound for several seconds every minute
-  will appear in display

Close door to silence alert and reset (Ice production will resume if bin sensor is not satisfied).

First Use

Initial startup requires no adjustments. See CONTROL OPERATION section for more details.

U-Line recommends discarding the ice produced during the first two to three hours of operation to avoid possible dirt or scale that may dislodge from the water line.

When plugged in, the unit will begin operating under the factory default settings. If the unit was turned off during installation, simply press  and the unit will immediately switch on. To turn the unit off, press  and release.

Ice

1 CLASS

The Nugget Ice Machine produces cylindrical bits of compressed ice approximately $\frac{3}{4}$ " x $\frac{1}{2}$ ".

Ice is produced until the machine senses the bin is full. As ice slowly melts in the bin, the level of ice drops and ice production resumes. This ensures a constant supply of fresh ice is always available.





3 CLASS AND ADA COLLECTION

The Nugget Ice Machine produces cylindrical bits of compressed ice approximately $\frac{3}{4}$ " x $\frac{1}{2}$ ".



Ice is produced until the machine senses the bin is full. As ice slowly melts in the bin, the level of ice drops and ice production resumes. This ensures a constant supply of fresh ice is always available.



The factory default ice setting is 0, which produces a firm and compact ice nugget. U-Line's exclusive U-Choose™ ice adjustability feature allows you five levels of adjustment from 0 to -5. At -5 the ice is soft and chewable.





To adjust the ice density:

1. Hold  for 5 seconds - display will flash current ice setting
2. Adjust using  or 
3. Confirm setting by pressing 

Cleaning

This ice machine has an automatic clean alert function. The control will indicate  in the display, approximately every six months with normal use, reminding you to clean your unit. When  is displayed, ice production will continue. Depending on water conditions, more frequent cleaning may be necessary. Cleaning removes lime scale, other mineral deposits, and sanitizes the machine. Poor ice quality and reduced ice output are signs that cleaning is necessary. If the machine consistently requires more frequent cleaning, consult a plumber to test the water quality and recommend appropriate treatment.

Under normal conditions cleaning should be done when the display shows . You may initiate a cleaning cycle at any time by pressing and holding the clean button for 10 seconds.  will appear in the display indicating the start of the cleaning process.

You may override  in the display without cleaning by pressing and holding the up, down, & light button for 10 seconds. **ICE** will scroll in the display and the cleaning reminder () will be reset for another approximate six month cycle. Failure to clean may reduce the quality and quantity of ice produced. Once the clean cycle begins, it can be canceled by pressing  three times. Press  once more to start making ice. The clean cycle will automatically cancel if user fails to activate control at steps 2, 3b, and 5b within 2 hours.

Required for cleaning:

- Hose and funnel – provided with unit
- Bucket and cleaning sponge
- Clean water
- SafeCLEAN Plus™ Cleaner (Part No. 80-55266-00)
– included with unit

Need more cleaner? Visit u-line.com.

⚠ CAUTION

Use only SafeCLEAN Plus™ Cleaner. Use of any other cleaner may damage the finish of the evaporator and will void the warranty.





Follow safety and handling instructions printed on the SafeCLEAN Plus™ bottle.

NOTICE:

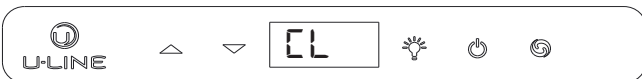
For 3 Class models only: the water filter must remain in place during the cleaning process.

Cleaning Process (approximate time: 40 minutes)



1. Press and Hold  for 5 - 10 seconds
 - a. **01** will appear in the display
 - b. Remove access shield
 - c. Remove all ice in bin
 - d. Remove any ice protruding from the ice dispenser tube
 - e. Insert the end of the cleaning tube into the ice dispenser; slowly pour in approximately 1 quart of hot water. This will melt ice inside the dispenser tube. It is normal for some water to flow out of the ice dispenser tube and exit from the vent tube while pouring. Omit this step if no ice is in the ice dispenser tube.
2. Press and release 
 - a. **02** will appear in the display
 - b. Mix 4 ounces of SafeCLEAN Plus™ with 2 quarts of water
3. Wait until **03** appears in the display
 - a. Using the funnel and cleaning tube, slowly pour $\frac{3}{4}$ of the cleaning solution into the dispenser tube. Air and some water will exit the vent tube. Remove cleaning tube.
 - b. Press and release 
4. **04** will appear in the display
 - a. The machine will circulate the solution, cleaning and sanitizing the internal components, for approximately 20 minutes
 - b. While the machine is circulating the cleaning solution, use the remaining cleaning solution and a sponge to wipe down the inside of the ice bin and scoop. Rinse thoroughly with clean water
5. When **05** appears in the display, 3 soft tones will sound, indicating the cleaning phase is complete
 - a. Using the hose and funnel, slowly pour 1.5 quarts (48 oz.) of clean water into the ice dispenser tube. Air and some water will exit the vent tube
 - b. Press and release 
6. **06** will appear in the display
 - a. Reinstall shield and close door - no further action is required
 - b. The machine will circulate water and perform a series of final rinses for approximately 15 minutes.

The unit will resume making ice - indicated by 3 soft tones and ICE scrolling in the display.

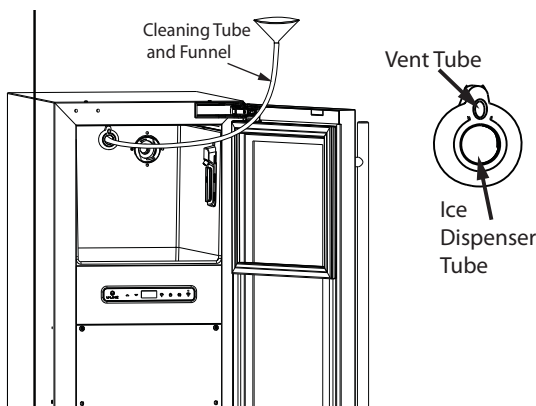

U-Line Corporation (U-Line) Limited Warranty

One Year Limited Warranty

For one year from the date of original purchase, this U-Line product warranty covers all parts and labor to repair or replace any part of the product that proves to be defective in materials or workmanship. For products installed and used for normal residential use, material cosmetic defects are included in this warranty, with coverage limited to 60 days from the date of original purchase. All service provided by U-Line under the above warranty must be performed by U-Line factory authorized service, unless otherwise specified by U-Line. Service provided during normal business hours.

Available Second Year Limited Warranty

Beyond the standard one year warranty outlined above, U-Line offers an extension of the one year warranty coverage for an additional second year from the date of purchase, free of charge. To take advantage of this second year warranty, you must register your product with U-Line within two months from the date of purchase at u-line.com providing proof of purchase.

Five Year Sealed System Limited Warranty

For five years from the date of original purchase, U-Line will repair or replace the following parts, labor not included, that prove to be defective in materials or workmanship: compressor, condenser, evaporator, drier, and all connecting tubing. All service provided by U-Line under the above warranty must be performed by U-Line factory authorized service, unless otherwise specified by U-Line. Service provided during normal business hours.

Terms

These warranties apply only to products installed in any one of the fifty states of the United States, the District of Columbia, or the ten provinces of Canada. The warranties do not cover any parts or labor to correct any defect caused by negligence, accident or improper use, maintenance, installation, service, repair, acts of God, fire, flood or other natural disasters. The product must be installed, operated, and maintained in accordance with the U-Line User Guide.

The remedies described above for each warranty are the only ones that U-Line will provide, either under these warranties or under any warranty arising by operation of law. U-Line will not be responsible for any consequential or incidental damages arising from the breach of these warranties or any other warranty, whether express, implied, or statutory. Some states do not allow the exclusion or limitation of incidental or consequential damages, so the above limitation or exclusion may not apply to you. These warranties give you specific legal rights, and you may also have other rights which vary from state to state.

Any warranty that may be implied in connection with your purchase or use of the product, including any warranty of merchantability or any warranty fit for a particular purpose is limited to the duration of these warranties, and only extends to five years in duration for the parts described in the section related to the five year limited warranty above. Some states do not allow limitations on how long an implied warranty lasts, so the above limitations may not apply to you.

- The warranties only apply to the original purchaser and are non-transferable.
- The second year and five year warranties cover products installed and used for normal residential or designated marine use only.
- The warranties apply to units operated outside only if designed for outdoor use by model and serial number.
- Replacement water filters, light bulbs, and other consumable parts are not covered by these warranties.
- The start of U-Line's obligation is limited to four years after the shipment date from U-Line.
- In-home instruction on how to use your product is not covered by these warranties.
- Food, beverage, and medicine loss are not covered by these warranties.
- If the product is located in an area where U-Line factory authorized service is not available, you may be responsible for a trip charge or you may be required to bring the product to a U-Line factory authorized service location at your own expense.
- Units purchased after use as floor displays, and/or certified reconditioned units, are covered by the limited one year warranty only and no coverage is provided for cosmetic defects
- Signal issues related to Wi-Fi connectivity are not covered by these warranties.

For parts and service assistance, or to find U-Line factory authorized service near you, contact U-Line:
8900 N. 55th Street, Milwaukee, WI 53223 • u-line.com • onlineservice@u-line.com • +1.800.779.2547