



PET HAIR ERASER[®] LIFT-OFF[®]

ENGINEERED FOR HOMES WITH PETS

QUICK START/USER GUIDE
2087 Series



More of a video person? Look for this icon and go online for an instructional how-to video at

www.BISSELL.com

Quick Start Guide

REFER TO PAGE 5 FOR COMPLETE USER GUIDE INSTRUCTIONS, PRODUCT VIEW, AND IMPORTANT SAFETY NOTICES.

Assembly

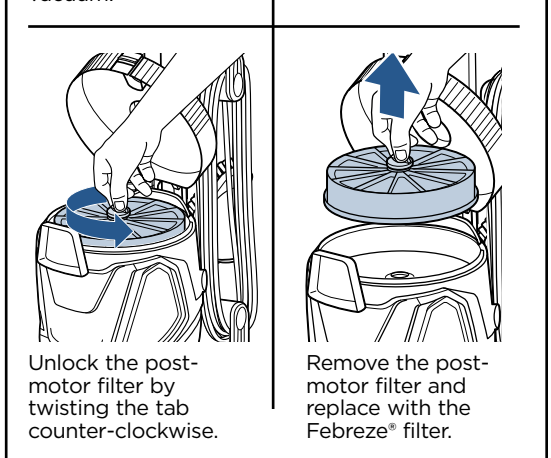
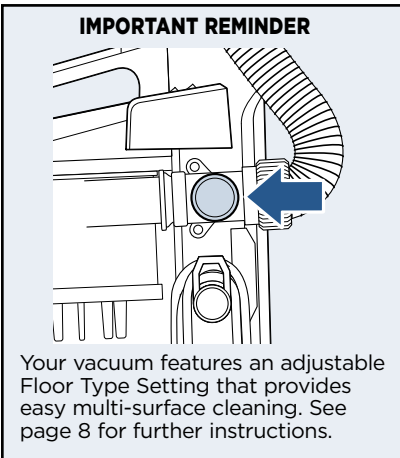
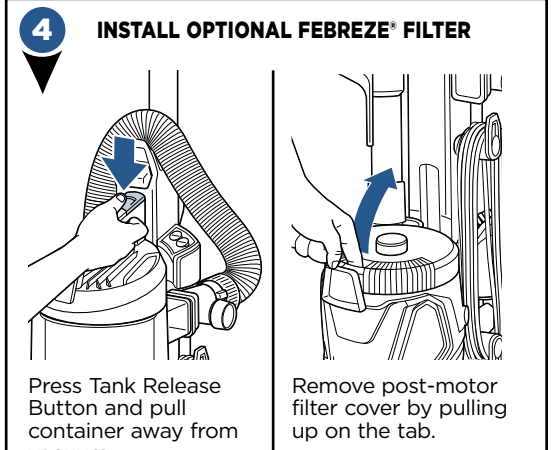
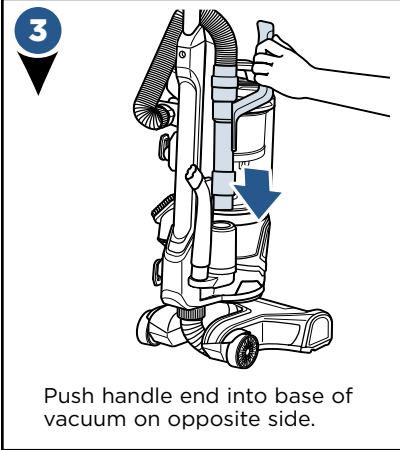
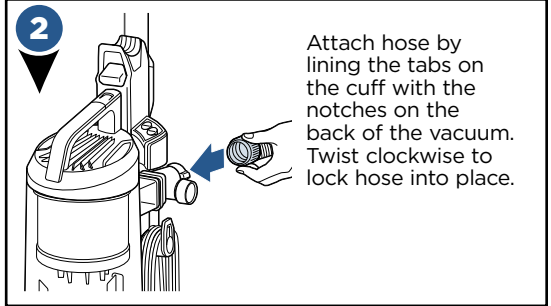
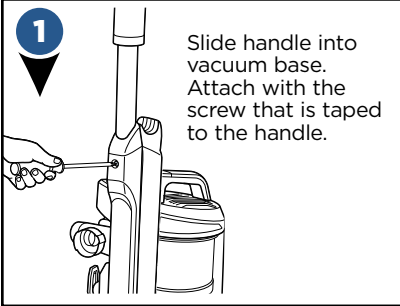

Built by Pet Owners

Cyclonic Pet Hair Spooling System™

BISSELL is the only vacuum brand with a Cyclonic Pet-Hair Spooling System™ for a Hands Free Empty.

A patented hair management system that spools and traps hair to keep it out of your filters and off your hands.

Just press the release button and watch the ball of pet hair drop right out.

You no longer have to reach up and pull the 'yuck' out.



Tangle Free Brush Roll

Pick up pet hair without having to cut it off your brush roll.



The Tangle Free Brush Roll's unique design helps reduce hair from wrapping and catching on the bristles, and uses the carpet to pull the hair off the brush roll.



Cut the hassle NOT the hair!

for Pet Owners

Specialized Pet Tools

Customize your cleaning with interchangeable tools stored right on board.



Soft dusting bristles for delicate surfaces and rubber fingers that can be engaged to remove embedded pet hair on stairs and furniture.



Uncover hidden dirt and pet hair with the LED Lighted Crevice Tool that allows you to reach in tight places.

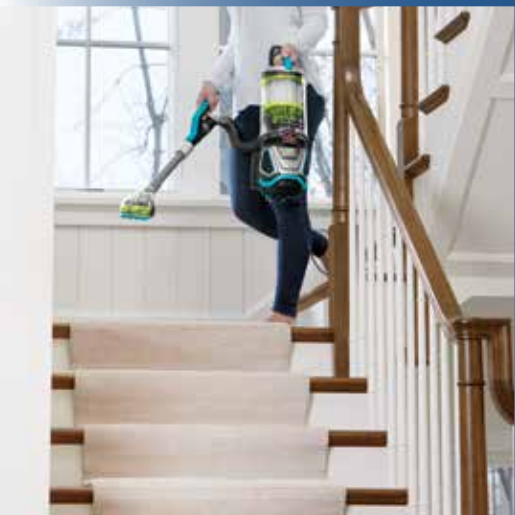
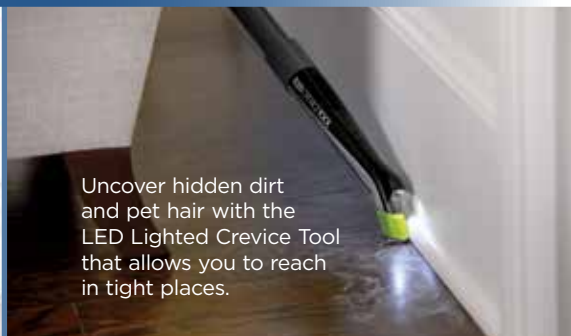

Power through pet hair on stairs and furniture with the Pet TurboEraser® Tool.



IMPORTANT SAFETY INSTRUCTIONS

READ ALL INSTRUCTIONS BEFORE USING YOUR UPRIGHT VACUUM.

Always connect to a polarized outlet (one slot is wider than the other). Unplug from outlet when not in use and before conducting maintenance. When using an electrical appliance, basic precautions should be observed, including the following:

WARNING

TO REDUCE THE RISK OF FIRE, ELECTRIC SHOCK, OR INJURY:

- » Do not leave vacuum cleaner when it is plugged in. Unplug from outlet when not in use and before servicing.
- » Do not use outdoors or on wet surfaces.
- » Do not allow to be used as a toy. Close attention is necessary when used by or near children.
- » Do not use for any purpose other than described in this User's Guide. Use only manufacturer's recommended attachments.
- » Do not use with damaged cord or plug. If appliance is not working as it should, has been dropped, damaged, left outdoors, or dropped into water, have it repaired at an authorized service center.
- » Do not pull or carry by cord, use cord as a handle, close a door on cord, or pull cord around sharp edges or corners. Do not run appliance over cord. Keep cord away from heated surfaces.
- » Do not unplug by pulling on cord. To unplug, grasp the plug, not the cord.
- » Do not handle plug or vacuum cleaner with wet hands.
- » Do not put any object into openings. Do not use with any opening blocked; keep openings free of dust, lint, hair, and anything that may reduce air flow.
- » Keep hair, loose clothing, fingers, and all parts of body away from openings and moving parts.
- » Turn off all controls before plugging or unplugging vacuum cleaner.
- » Use extra care when cleaning on stairs.
- » Do not use to pick up flammable or combustible materials (lighter fluid, gasoline, kerosene, etc.) or use in areas where they may be present.
- » Do not use vacuum cleaner in an enclosed space filled with vapors given off by oil base paint, paint thinner, some moth proofing substances, flammable dust, or other explosive or toxic vapors.
- » Do not use to pick up toxic material (chlorine bleach, ammonia, drain cleaner, etc.).
- » Do not pick up anything that is burning or smoking, such as cigarettes, matches, or hot ashes.
- » Do not use without filters in place.
- » Do not pick up hard or sharp objects such as glass, nails, screws, coins, etc.
- » Use only on dry, indoor surfaces.
- » Keep appliance on a level surface.
- » Do not carry the vacuum cleaner while it is running.
- » Unplug before connecting or disconnecting the TurboBrush® Tool.

LED LIGHTED CREVICE TOOL WARNING

- Caution: Risk of fire and burns. Do not recharge, disassemble, heat above 60°C (140°F) or incinerate. Keep batteries out of reach of children and in original package until ready to use. Dispose of used batteries promptly.
- Never put batteries in mouth. If swallowed, contact your physician or local poison control.
- Replace Battery With CR1632 Only. **USE OF ANOTHER BATTERY MAY PRESENT A RISK OF FIRE OR EXPLOSION.** CR1632 cells may be purchased anywhere batteries are sold.

READ OPERATOR'S MANUAL



SAVE THESE INSTRUCTIONS

This model is for household use only.

WARNING

- » Plastic film can be dangerous. To avoid danger of suffocation, keep away from children.
- » Do not plug in your vacuum cleaner UNTIL you are familiar with all instructions and operating procedures.
- » To reduce the risk of electrical shock, turn power switch off and disconnect polarized plug from electrical outlet BEFORE performing maintenance or troubleshooting checks.

Thanks for buying a BISSELL vacuum!

We love to clean and we're excited to share one of our new innovative products with you. We want to make sure your vacuum works as well in five years as it does today, so this guide has tips on using (page 7-11), maintaining (pages 12-15), and if there is a problem, troubleshooting (page 16).

What's in the Box?

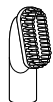

2-in-1 Pet Brush



Febreze® Filter
Style 2087
(optional use)

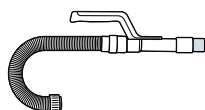

Hose / Telescoping
Extension Wand
(if desired, wand can be
removed from hose)

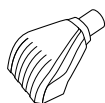

Pet TurboEraser®
Tool



LED Lighted
Crevice Tool

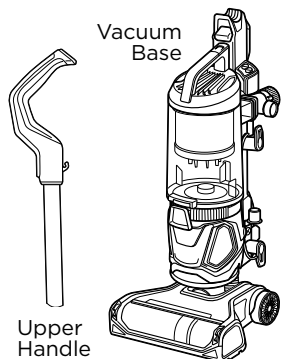

Vacuum
Base

Upper
Handle

NOTE: Standard accessories may vary by model. To identify what should be included with your purchase, please refer to the “Carton Contents” list located on the carton top flap.

Quick Start / Assembly	2	Troubleshooting	16
New Pet Innovation	3-4	Warranty	17
Safety Instructions	5	Service	17
Product View	7	Contact Information	17
Operations	8-11	Product Registration	18
Maintenance & Care	12-15	Parts & Supplies	18

Product View

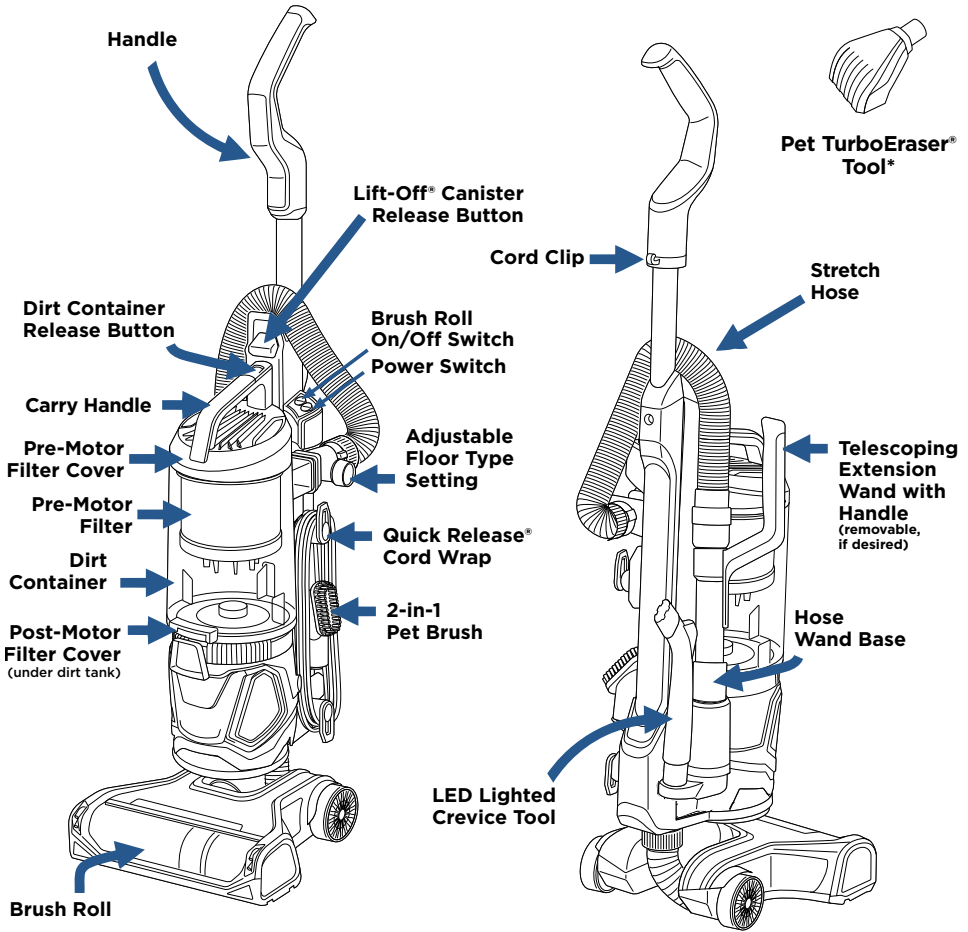

***NOTE:** Pet TurboEraser® Tool does not store on unit.

THIS APPLIANCE HAS A POLARIZED PLUG

To reduce the risk of electric shock, this appliance has a polarized plug (one blade is wider than the other). This plug will fit in a polarized outlet only one way. If the plug does not fit fully in the outlet, reverse the plug. If it still does not fit, contact a qualified electrician to install a proper outlet. Do not change the plug in any way.

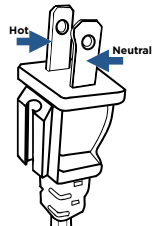

Operations

WARNING

Do not plug in your vacuum until you are familiar with all instructions and operating procedures.

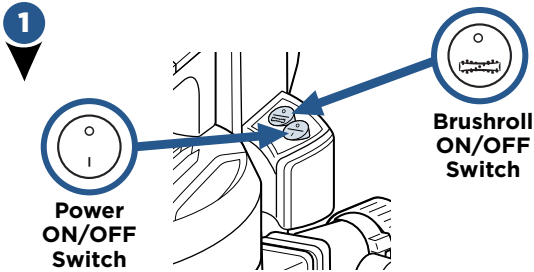

Turn vacuum on by pressing Power Switch on (I - ON and O - OFF). Press Brush Roll switch to run the PowerBrush for carpet cleaning (brush roll is on when light on switch is illuminated). See page 15 to maintain the brush roll.

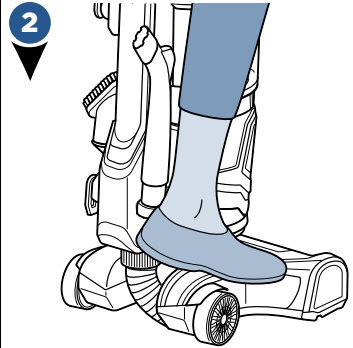

Step gently on base and pull back on handle to recline.

NOTE: The brush roll will automatically shut off when vacuum is locked in upright position, recline to reactivate.

NOTE: In the unlikely event that hair wrapped around your brush roll, run vacuum back and forth on clean carpet several times to help release any wrapped hair.

NOTE: Turn off the brush roll when vacuuming hard or delicate surfaces that may be caught by the rotating brush. This could include hard wood, tiled floors, small area rugs or frieze carpets that have long delicate fibers or threads.

Adjusting the Floor Type Setting

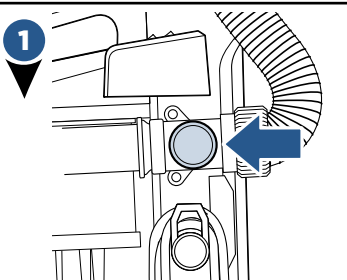

Locate the Floor Type Setting on the side of the vacuum.



Turn the knob to the LEFT for high pile carpet and to the RIGHT for bare floors.

Above Floor Cleaning

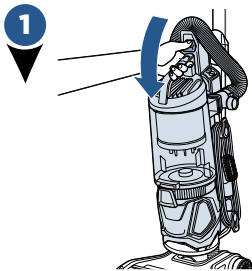

1
Clean stairs or furniture easily with the removable canister. Push the Lift-Off button to remove and attach desired tool.

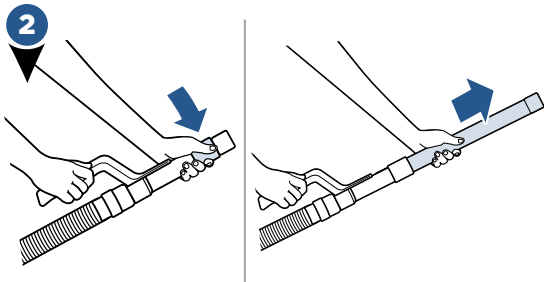

2
For the most reach, extend the telescoping extension wand by twisting to the right to unlock. Then slide the telescoping extension wand to your desired length.

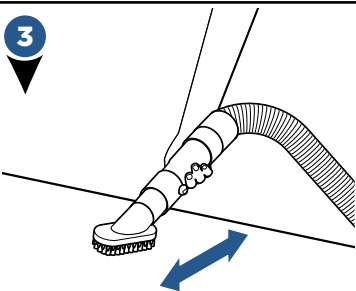

3
If desired, the telescoping extension wand can be removed from the hose. To do so, grab the telescoping wand handle and pull up while holding the end of the hose.

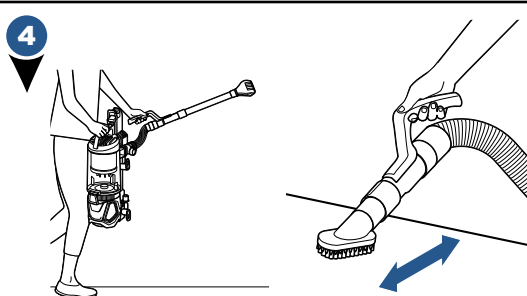

4
Attach desired tool. Use the Pet TurboEraser® tool for best results on your stairs. Or use the 2-in-1 Pet Brush which has white soft bristles for more sensitive/gentle surfaces and rubber nubs for embedded pet hair.

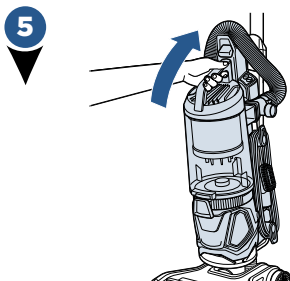

5
When finished, replace the canister back on vacuum by aligning the front with the base of vacuum, then lean canister back and lock into place.

NOTE: When wrapping the cord, be sure that it is placed securely around the cord wraps. If it falls behind the lift-off canister, it can impede reattachment.

LED Lighted Crevice Tool

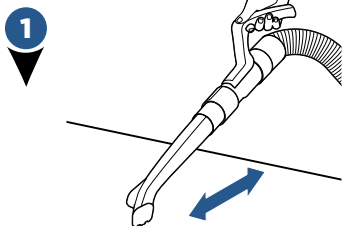

Pull tabs out of battery door area before use to activate. Connect to wand or hose and the LED Light will automatically come on.

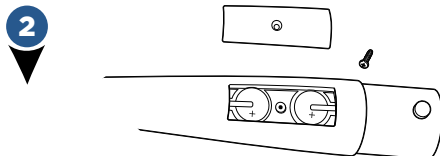

To replace LED battery, unscrew the small screw with a Phillips head screw driver. Pull cover off to reveal two batteries (CR1632 3V). Slide and pull out each battery and replace with new. Be sure the “+” sign on battery is facing out. Dispose of used battery promptly. Keep away from children. Do not disassemble and do not dispose of in fire.

NOTE: When the small tab on the connection point of Crevice tool comes into contact with the handle, wand, or hose; that triggers the LED light to come on.

Vacuum Motor Protection

An internal thermal protector has been designed into your vacuum to protect it from overheating. When the thermal protector activates, the main vacuum motor will stop operating. If this happens, proceed as follows.

- 1 Turn vacuum OFF and unplug from electrical outlet.
- 2 Check for the source of overheating problem (full dirt cup, dirty filters or, a clog) and fix by following the maintenance instructions.
- 3 When the motor cools for approximately 30 minutes, the thermal protector automatically resets and cleaning may continue. If the vacuum will not turn on or the thermal protector continues to activate, your vacuum may need servicing. Call BISSELL Consumer Care.

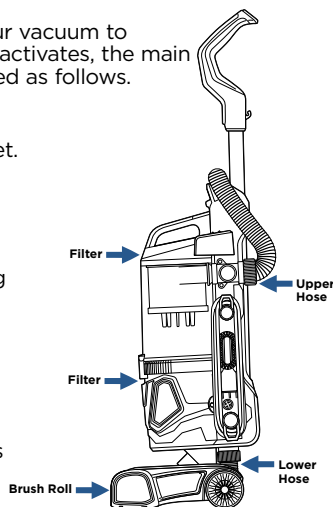

Possible areas that could clog.

NOTE: The thermal protector controls the main vacuum motor only, not the brush motor. If the thermal protector activates, the brush will continue to operate normally; however, there will be no suction.

Remove/Empty Dirt Container

⚠️ WARNING

To reduce the risk of electrical shock, turn power switch OFF and disconnect polarized plug from electrical outlet before performing maintenance or troubleshooting checks.

1

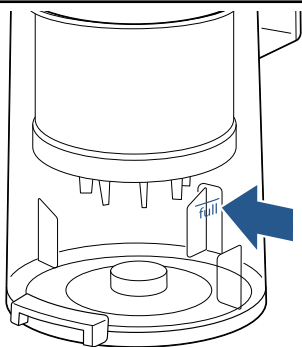

The dirt container is full. Time to empty!

2

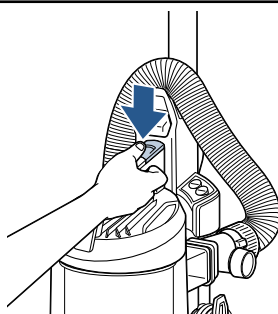

Press the Release Button and grab the handle to pull the dirt container away from vacuum.

3

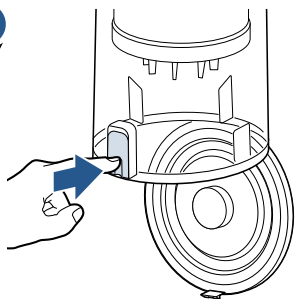

Hold the dirt container over a trash bin and press the Empty Button. Once emptied, snap bottom back into place.

4

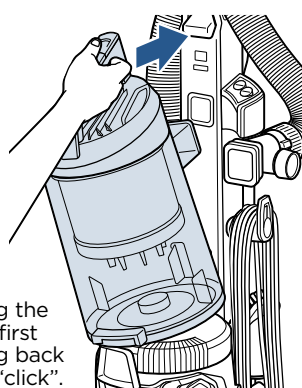

Return the dirt container to the vacuum, securing the bottom in place first and then pushing back until you hear a “click”.

⚠️ WARNING

Do not operate vacuum with damp or wet filters. Allow components to dry before reassembling the dirt container.

⚠️ WARNING

Before using your vacuum, make sure that the dirt container is in locked position and that all filters, both pre and post-filters are in place. DO NOT operate your vacuum without these filters.

Clean/Replace Pre-Motor Filters

WARNING

To reduce the risk of electrical shock, turn power switch OFF and disconnect polarized plug from electrical outlet before performing maintenance or troubleshooting checks.

WARNING

Do not operate vacuum with damp or wet filters. Allow components to dry before reassembling the dirt container.

1

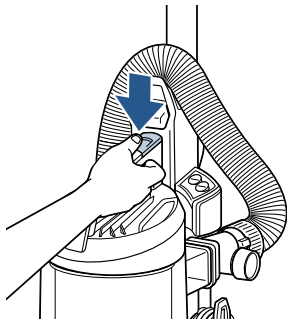

Press the dirt container Release Button and pull away from vacuum.

2

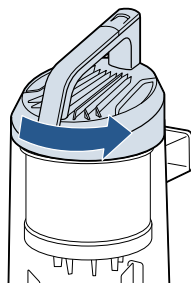

Twist tank cover to the unlock position then pull up on handle.

3

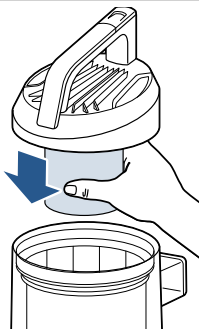

Pull down on the pre-motor filter to remove.

4

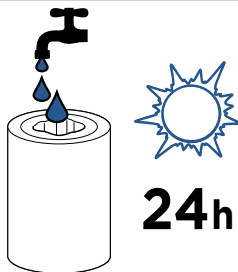

There are three pieces to the pre-motor filter. All are washable. Be sure all filters are fully dry and that all layers are installed before returning them to the vacuum.

NOTE: Replace this filter every 3 to 6 months. Visit [BISSELL.com](http://www.BISSELL.com) for Style 2087 filter replacements.

Parts & Supplies

For Parts and Supplies, go to www.BISSELL.com and enter your model number in the search field.

Clean/Replace Post-Motor Filter

WARNING

To reduce the risk of electrical shock, turn power switch OFF and disconnect polarized plug from electrical outlet before performing maintenance or troubleshooting checks.

WARNING

Do not operate vacuum with damp or wet filters. Allow components to dry before reassembling the dirt container.

1

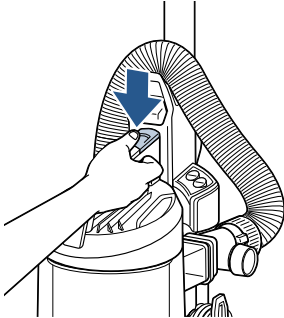

Press the dirt container Release Button and pull container away from vacuum.

2

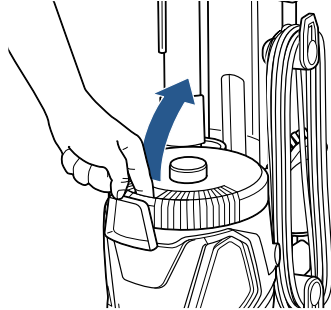

Remove post-motor filter cover by pulling up on the tab.

3

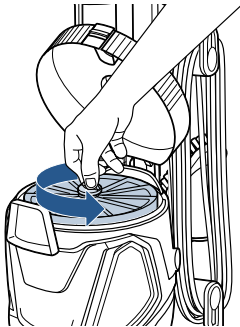

Unlock the post-motor filter by twisting the tab counter-clockwise.

4

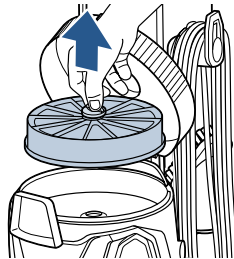

Remove the post-motor filter. When reassembling, be sure to lock the filter back into place. The pleated filter may NOT be washed. If dust/debris accumulates, gently tap the filter on the inside of a trash bin.

NOTE: Replace this filter every 3 to 6 months. Visit BISSELL.com for Style 2087 filter replacements.

Clean Inner Cyclone Separator

1

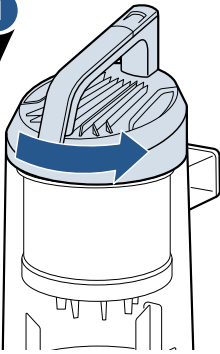

Twist tank cover to the unlock position then pull up on handle to access bulk separator.

2

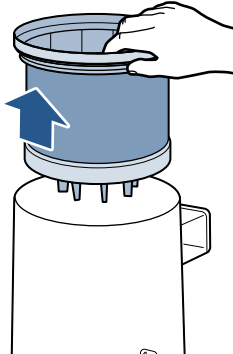

Pull up to remove the bulk separator from dirt container.

3

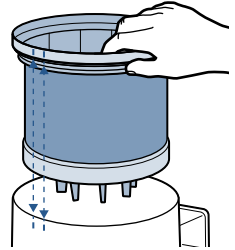

Tap separator against inside of trash bin and rinse under warm water, if necessary. Be sure to let it completely dry before placing back in dirt container. When replacing, be sure that separator aligns with the upper tank to ensure fit.

Maintain Pet TurboEraser® Tool

1

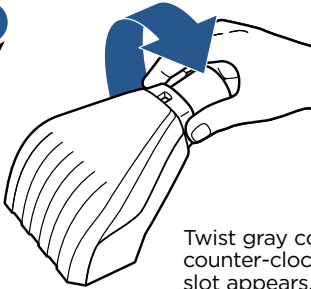

Twist gray collar counter-clockwise, until slot appears, and then separate faceplate.

2

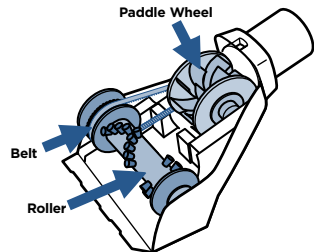

Remove brush roll, belt, and paddle wheel. Inspect for damages and replace if necessary.

3

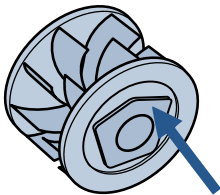

To reassemble, align two clips on each end of paddle wheel with belt on and pop back into place. Place brush roll with belt back in. Faceplate will not close properly if all parts are not aligned correctly.

4

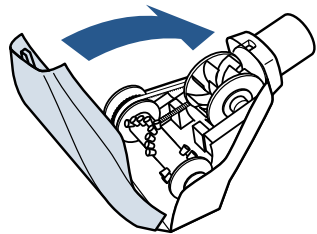

To put faceplate back on, align the tabs in the top of the cover and place it down to “click” into place.

Replace Brush and Belt

1

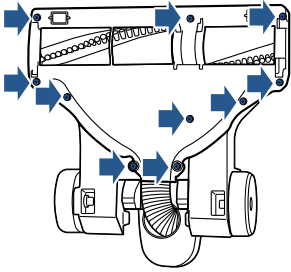

Unplug and turn vacuum over. Unscrew 10 Phillips head screws to remove bottom cover.

2

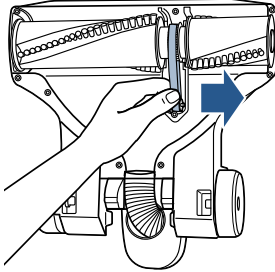

Pull roller straight out and slide belt off motor gear. Replace roller and/or belt.

3

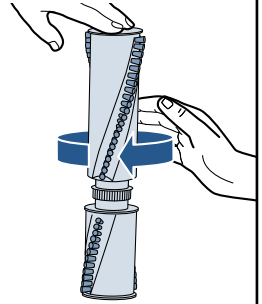

1. Inspect brush roll by placing it on its end and spin. The brush roll should spin freely, multiple times by one flick. If it doesn't, replace brush roll.
2. Inspect belt, replace if it appears damaged.

4

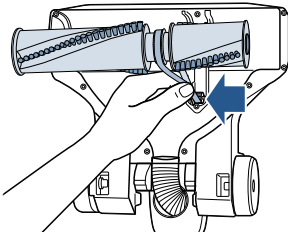

1. Place belt back on brush roll.
2. Pinch belt around brush roll & hook back around the motor gear.

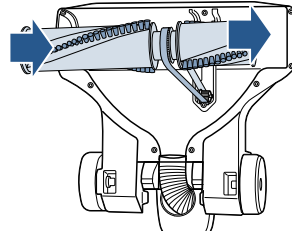

3. Rotate brush roll into place and line up end caps.
4. Re-attach bottom cover with 10 screws.

NOTE: If an object becomes lodged in foot and brush shuts off, turn vacuum off and unplug from electrical outlet. Remove obstruction and brush will automatically reset when vacuum is plugged and turned back on.

Parts & Supplies

For Parts and Supplies, go to www.BISSELL.com and enter your model number in the search field.

Troubleshooting

⚠️ WARNING To reduce the risk of electric shock, turn power switch off and disconnect plug from electrical outlet before performing maintenance or troubleshooting checks.

Problem	Possible causes	Remedies
Brush roll doesn't rotate	Brush roll switch is turned off.	Make sure Brush roll switch is on.
	Vacuum is locked in upright position.	Recline vacuum and switch on the Brush roll.
	Vacuumping on Premium Soft Carpet.	Turn the Floor Type Setting towards high carpet.
	Brush roll has lodged debris or other entanglements, keeping the brush from rotating.	Unplug, check for debris, and remove the debris.
Vacuum won't pick up dirt	Pod is not securely seated.	Remove pod and replace, making sure that it "clicks" into place.
	Filters are dirty.	Remove and rinse pre-motor filters. Allow enough time for them to dry properly before reinserting. Remove and dust off post-motor filter.
	There is a clog in the vacuum.	Remove debris and any other entanglements that may be restricting the brush rolls rotation.
	Dirt Container is not seated correctly.	Press the Tank Release to release the Dirt Container and reseat properly.
	There is a crack or hole in the Main Hose.	If there is a crack or hole, order a new Main Hose from the BISSELL website.
	Main Hose is not connected.	Locate the Main Hose and reconnect by pushing the hose connection.
	There is a clog in the hose.	Check inside of hose for clogs by disconnecting from vacuum.
Hair wrapped around brush roll.	Run vacuum back and forth on clean carpet several times to release wrapped hair.	
Dirt is escaping from the vacuum	Dirt Container is full.	Empty the Dirt Container.
	Filters are missing.	Check to see if all of the Pre-Motor and Post-Motor filters are in place.
Hose won't pick up dirt	Vacuum is in the wrong Floor Type Setting.	Turn the knob towards the bare floor setting.
Vacuum is hard to push or pull	Vacuum is in the wrong Floor Type Setting.	Turn the knob towards the high carpet setting.

Warranty

This warranty gives you specific legal rights, and you may also have other rights which may vary from state to state. If you need additional instruction regarding this warranty or have questions regarding what it may cover, please contact BISSELL Consumer Care by E-mail, telephone, or regular mail as described below.

Limited Five-Year Warranty

Subject to the *EXCEPTIONS AND EXCLUSIONS identified below, upon receipt of the product BISSELL will repair or replace (with new or remanufactured components or products), at BISSELL's option, free of charge from the date of purchase by the original purchaser, for five years any defective or malfunctioning part.

See information below on "If your BISSELL product should require service".

This warranty applies to product used for personal, and not commercial or rental service. This warranty does not apply to fans or routine maintenance components such as filters, belts, or brushes. Damage or malfunction caused by negligence, abuse, neglect, unauthorized repair, or any other use not in accordance with the User's Guide is not covered.

BISSELL IS NOT LIABLE FOR INCIDENTAL OR CONSEQUENTIAL DAMAGES OF ANY NATURE ASSOCIATED WITH THE USE OF THIS PRODUCT. BISSELL'S LIABILITY WILL NOT EXCEED THE PURCHASE PRICE OF THE PRODUCT.

Some states do not allow the exclusion or limitation of incidental or consequential damages, so the above limitation or exclusion may not apply to you.

*EXCEPTIONS AND EXCLUSIONS FROM THE TERMS OF THE LIMITED WARRANTY

THIS WARRANTY IS EXCLUSIVE AND IN LIEU OF ANY OTHER WARRANTIES EITHER ORAL OR WRITTEN. ANY IMPLIED WARRANTIES WHICH MAY ARISE BY OPERATION OF LAW, INCLUDING THE IMPLIED WARRANTIES OF MERCHANTABILITY AND FITNESS FOR A PARTICULAR PURPOSE, ARE LIMITED TO THE FIVE YEAR DURATION FROM THE DATE OF PURCHASE AS DESCRIBED ABOVE.

Some states do not allow limitations on how long an implied warranty lasts so the above limitation may not apply to you.

NOTE: Please keep your original sales receipt. It provides proof of date of purchase in the event of a warranty claim.

Service

If your BISSELL product should require service:

Contact BISSELL Consumer Care to locate a BISSELL Authorized Service Center in your area.

If you need information about repairs or replacement parts, or if you have questions about your warranty, contact BISSELL Consumer Care.

Website:

www.BISSELL.com

E-mail:

www.BISSELL.com/email-us

Call:

BISSELL Consumer Care
1-800-237-7691

Monday - Friday 8am - 10pm ET

Saturday 9am - 8pm ET

Sunday 10am - 7pm ET

Please do not return this product to the store.

Other maintenance or service not included in the manual should be performed by an authorized service representative.

For any questions or concerns, BISSELL is happy to be of service. Contact us directly at 1-800-237-7691.

Register your product today!

Registering is quick, easy and offers you benefits over the lifetime of your product.

You'll receive:

BISSELL Rewards Points

Automatically earn points for discounts and free shipping on future purchases.

Faster Service

Supplying your information now saves you time should you need to contact us with questions regarding your product.

Product Support Reminders and Alerts

We'll contact you with any important product maintenance reminders and alerts.

Special Promotions

Optional: Register your email to receive notice of offers, contests, cleaning tips and more!

Visit www.BISSELL.com/registration!

Visit the BISSELL website: www.BISSELL.com

When contacting BISSELL, have model number of cleaner available.

Please record your Model Number: _____

Please record your Purchase Date: _____

NOTE: Please keep your original sales receipt. It provides proof of purchase date in the event of a warranty claim. See the Warranty page for details.

Parts & Supplies

For Parts and Supplies, go to www.BISSELL.com and enter your model number in the search field.

We can't wait to hear from you!

Rate this product and let us (and millions of your closest friends) know what you think!

www.BISSELL.com



©2017 BISSELL Homecare, Inc.
Grand Rapids, Michigan
All rights reserved. Printed in China
Part Number 161-2289 06/17 RevB
Visit our website at: www.BISSELL.com