



USER'S MANUAL

THD SERIES



www.NightOwlSP.com



Specifically
Designed for
Smartphones



Specifically
Designed for
Tablets

Thank you for choosing Night Owl Security Products!

By purchasing a Night Owl product, you receive a one (1) year warranty covering manufacturing defects in material and workmanship. In addition to warranty and technical support benefits, you will have access to our multitude of free instructional “How to Videos”. You can also view our instructional videos by clicking the “How to Videos” tab within your product’s page on our website.



Register at www.NightOwlSP.com

Night Owl’s THD Series Camera Compatibility:

The Night Owl THD System is compatible with the following models:

CM-AHD10W-BU; CM-AHD7B-BU; CM-HDA10W-BU; CM-HDA10W-DMA; CM-HDA7B-BU; CM-PIRHDA10W-BU; CM-PTH30W-BU-HIK; CM-THD10W-BU; CM-THD30W-BU-HIK (CM-650-H), (CM-724-H), (PC-624N-H), (CM-930A-TU), (DM-924A-TU), (PC-624-H), (DM-724-TU), (CM-MINI-908-H), (DM-924-TU), (DM-624T-BA)

If the camera’s video quality either day or night is degraded, you may need to change the cable run from the camera to the DVR. This system is designed to work with CL2 UL Rated cabling or better.

Please see the warranty section of this manual for exclusions and additional details. Not all features and capabilities are shared across all models so you may see features which are not applicable. In addition you may see screen images that do not exactly match those on your display.

THIS MANUAL WAS ACCURATE AT THE TIME IT WAS COMPLETED. DUE TO OUR ONGOING EFFORT TO CONSTANTLY IMPROVE OUR PRODUCTS, FUNCTIONS MAY HAVE BEEN ADDED OR CHANGED.

Before setting up your system, you MUST update your DVR’s firmware. Please follow these steps:

- 1 Connect one end of the included Ethernet cable into the LAN port on the back of your DVR. Connect the other end into your Modem/Router to establish an Internet connection.
- 2 Next, connect the DVR to your TV/Monitor using the provided HDMI cable. If your TV/Monitor does not have an HDMI port, you may use a VGA cable (*not provided*).
- 3 Using the provided DVR power adapter, power on the DVR.
- 4 Once the DVR is powered on, the Startup Wizard will begin. Follow the steps within the Startup Wizard to upgrade your system’s firmware.

NOTE: Your DVR must be connected to the Internet in order to upgrade the firmware.

Quick Setup Guide

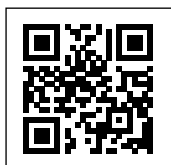

Use a QR Code scanner on your Smart Device to scan the QR Code. Scan the QR code to the left to access the Quick Setup Guide for assistance in configuring Night Owl Security system.



TABLE OF CONTENTS

Table of Contents

Chapter 1: FCC Warnings	8
Chapter 2: Safety Instructions	10
Chapter 3: App Overview	12
Chapter 4: Specifications	14
4.1 System Requirements	14
4.2 Package Contents	14
4.2.1 DVR Diagram	14
4.2.2 Camera Diagram	16
4.2.3 Mouse Diagram	16
Chapter 5: Camera Installation.	18
5.1 Video/Audio	18
5.2 Power	19
5.2.1 Standard Camera Power	19
5.3 Mounting the Cameras.	20
Chapter 6: DVR Installation	23
6.1 Connecting to a TV (via HDMI)	23
6.2 Power	24
Chapter 7: Getting Started.	26
7.1 Startup Wizard	26
7.1.1 Camera Test	27
7.1.2 Network Check	27
7.1.3 Firmware Check.	29
7.1.4 Password Creation	30
7.1.5 Date and Time Setup	31
7.1.6 Night Owl Apps	31
7.1.6 (a) Using Night Owl X and Night Owl X HD.	33
7.1.6 (b) App Overview	36
7.1.7 Password Verification	37
7.1.8 Camera/Channel Settings	37
7.1.9 Camera Adjustment	38
7.1.10 Channel Settings	38
7.1.11 Default View	39
7.1.12 Helpful Links	40
7.1.13 Wizard Complete	41
7.2 Displays and Icons	42
7.2.1 Live View (All Channels)	42
7.2.2 Right-Click Menu.	43
7.2.3 Channel Toolbar	44
7.2.4 Login	45

- Chapter 8: Menus and Settings** **47**
- 8.1 Video Playback** **49**
- 8.2 Search/Export** **52**
- 8.3 Camera Management** **53**
 - 8.3.1 On Screen Display** **54**
 - 8.3.2 Image Settings** **55**
 - 8.3.3 Camera Parameter Settings** **56**
 - 8.3.4 PTZ** **57**
 - 8.3.5 Motion** **58**
 - 8.3.6 Privacy Mask** **59**
 - 8.3.7 Video Tampering** **59**
 - 8.3.8 Video Loss** **60**
- 8.4 Record** **61**
 - 8.4.1 Schedule** **61**
 - 8.4.2 Video Quality Settings** **62**
 - 8.4.3 Overwrite Recordings** **64**
- 8.5 Hard Drive** **64**
- 8.6 Configuration** **65**
 - 8.6.1 General** **65**
 - 8.6.1 (a) General** **65**
 - 8.6.1 (b) DST (Daylight Savings Time)** **66**
 - 8.6.1 (c) More Settings** **66**
 - 8.6.2 Network** **67**
 - 8.6.2 (a) General** **67**
 - 8.6.2 (b) Remote Access** **68**
 - 8.6.2 (c) DDNS** **68**
 - 8.6.2 (d) NTP** **69**
 - 8.6.2 (e) Email** **69**
 - 8.6.3 Live View** **71**
 - 8.6.4 System Events** **72**
 - 8.6.5 User** **73**
- 8.7 Maintenance** **73**
 - 8.7.1 System Info** **74**
 - 8.7.1 (a) Device Info** **74**
 - 8.7.1 (b) Camera** **74**
 - 8.7.1 (c) Record** **75**
 - 8.7.1 (d) Network** **75**
 - 8.7.1 (e) HDD** **76**
 - 8.7.2 Log Information** **76**
 - 8.7.3 Import/Export** **77**
 - 8.7.4 Upgrade** **78**
 - 8.7.5 Default** **78**

Chapter 9: Glossary **81**
Chapter 10: Warranty **83**
Chapter 11: Troubleshooting **86**
Chapter 12: User Information **89**
Customer Support. **Back Cover**



Night Owl's DVRs are manufactured for quality and ease of use. As such, our DVRs contain menus designed for advanced users that should not be adjusted without having enhanced knowledge regarding the menu. In most cases the default settings allow for optimal functionality. The menus that should maintain the default settings are indicated with this icon.



CHAPTER 1

FCC WARNINGS

Chapter 1: FCC Warnings

FCC

This device complies with Part 15 of the FCC Rules. Operation is subject to the following two conditions: (1) this device may not cause harmful interference and (2) this device must accept any interference received, including interference that may cause undesired operation.

FCC Compliance Statement

These limits are designed to provide reasonable protection against frequency interference in residential installation. This equipment generates, uses and can radiate radio frequency energy and if not installed or used in accordance with the instructions, may cause harmful interference to radio communication. However, there is no guarantee that interference will not occur in television reception, which can be determined by turning the equipment off and on. The user is encouraged to try and correct the interference by one or more of the following measures:

- Reorient or relocate the receiving antenna.
- Increase the separation between the equipment and the receiver.
- Connect the equipment into an outlet on a circuit different from that to which the receiver is connected.
- Consult the dealer or an experienced radio/TV technician for help.

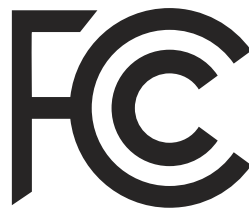

CAUTION!

The Federal Communications Commission warns the user that changes or modifications to the unit not expressly approved by the part responsible for compliance could void the user's authority to operate the equipment.

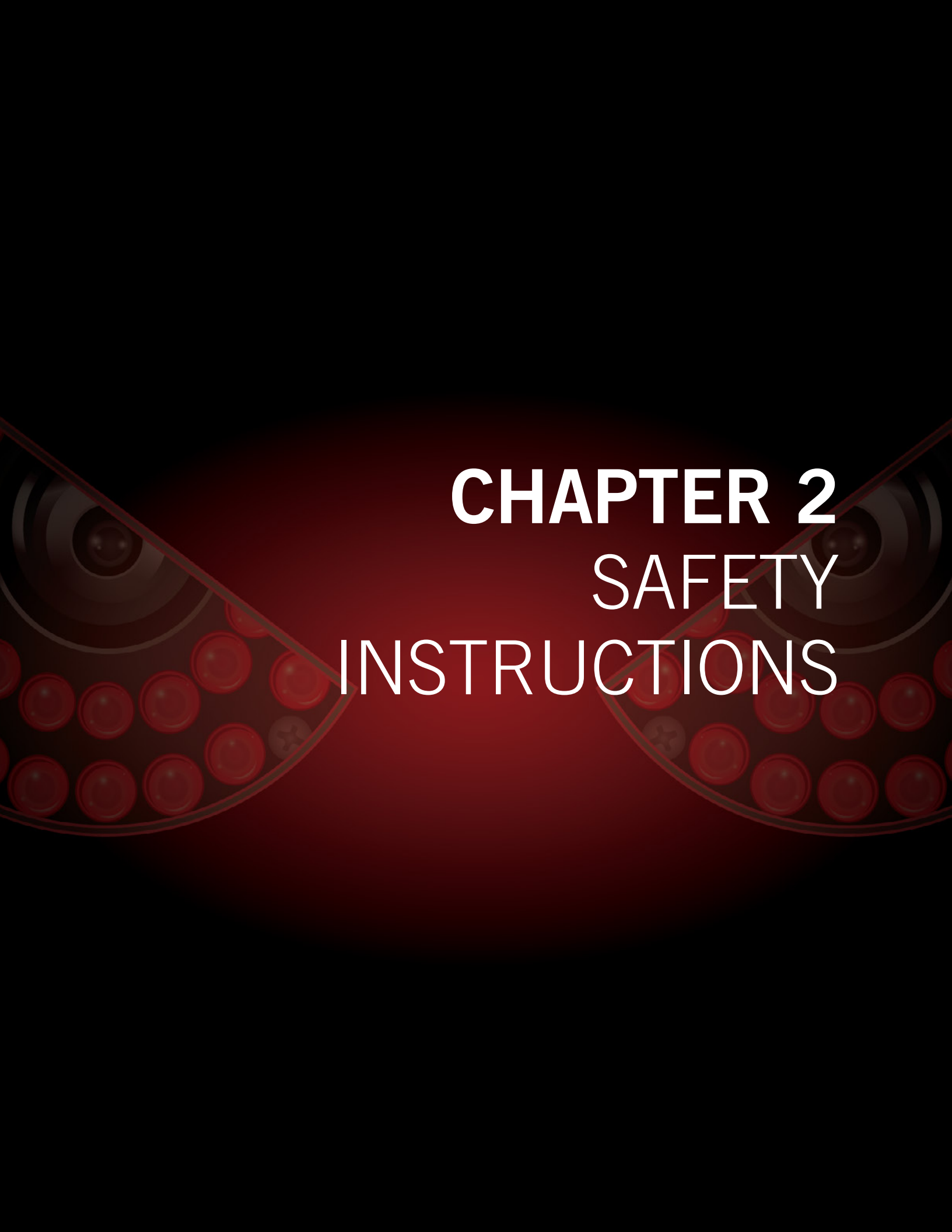
The background features a dark red gradient with a diagonal line running from the top-left to the bottom-right. On either side of this line, there are semi-circular patterns of red circles, resembling a keyboard or a control panel. The text is centered in the middle of the page.

CHAPTER 2

SAFETY

INSTRUCTIONS

Chapter 2: Safety Instructions

- **USE THE PROVIDED POWER ADAPTER.**

Do not use this product with a power source that applies more than the specified voltage.

- **NEVER INSERT METAL INTO THE DVR CASE OR ITS OPENINGS.**

Inserting metal into the DVR case may cause electric shock.

- **DO NOT OPERATE IN WET OR DUSTY AREAS.**

Avoid placing the DVR in areas such as a damp basement or dusty attic.

- **DO NOT EXPOSE THE DVR TO RAIN OR USE NEAR WATER.**

If the DVR accidentally gets wet, unplug it and contact technical support immediately.

- **KEEP PRODUCT SURFACES CLEAN AND DRY.**

To clean the outside case of the DVR, use a lightly dampened cloth. Do not use cleaning solutions or solvents.

- **DO NOT INSTALL NEAR ANY HEAT SOURCES.**

Do not install the DVR near any heat sources such as stoves, heat registers, radiators or electronics (including amplifiers) that produce heat.

- **UNPLUG THE DVR WHEN MOVING IT.**

Make sure that the DVR is unplugged before you move it. When moving this device, be sure to handle it with care.

- **MAKE SURE THERE IS GOOD AIR CIRCULATION AROUND THE DVR.**

This DVR uses an internal hard drive, which generates heat during operation for video storage. Do not block vents on the DVR, as these vents reduce the generated heat while the system is running. Place this product in well-ventilated area.

- **DO NOT ATTEMPT TO REMOVE THE TOP COVER.**

If you observe any abnormal operation, unplug the DVR immediately and contact technical support. Do not attempt to open the DVR to diagnose the cause of the problem.

- **HANDLE THE DVR CAREFULLY.**

If you drop the DVR on any hard surface, it may damage the device. If the DVR doesn't work properly due to physical damage, contact an authorized dealer for repair.

- **IT IS RECOMMENDED TO USE YOUR DVR WITH AN UNINTERRUPTIBLE POWER SUPPLY (UPS).**

Connecting your DVR and cameras to a UPS allows continuous operation even during power outages. The run-time duration will depend on the rating of the UPS used.

CAUTION!



You may be subjected to severe electrical shock if you remove the cover of the DVR.



CHAPTER 3

APP OVERVIEW

Chapter 3: App Overview

NOTE: The following instructions lead you through the steps for downloading the correct application for your Smart Device. Please refer to Pg. 33 of this User's Manual for instructions on how to create an account and add your device.

Night Owl fits right in with your mobile lifestyle by allowing you to remotely monitor your home or business. Our free and exclusive Night Owl X app for iOS® and Android™ phones and Night Owl X HD for iOS® and Android™ tablets are available in the *App Store* and *Google Play Store*.



NOTE: To ensure the best customer experience make sure you download the correct app for your device.

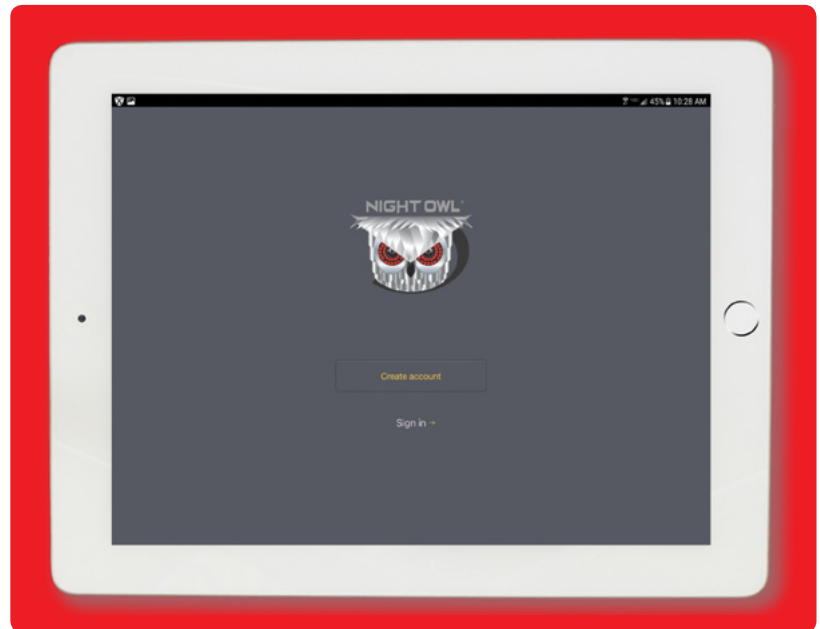
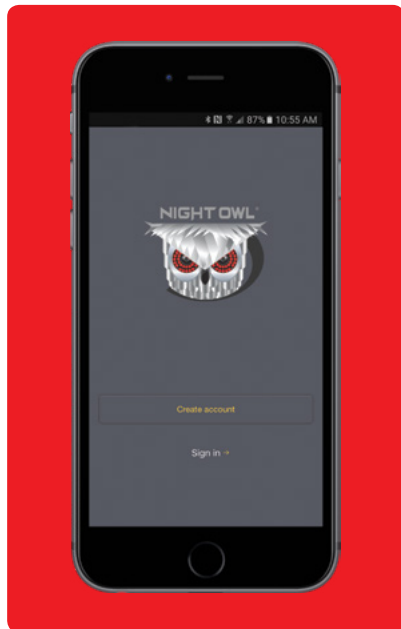

Night Owl X

SMARTPHONES

For remote viewing on an iOS® or Android™ phone, make sure you download **Night Owl X**.



Night Owl X HD

TABLETS

For remote viewing on an iOS® or Android™ tablet, make sure you download **Night Owl X HD**.



CHAPTER 4

SPECIFICATIONS

Chapter 4: Specifications

4.1 System Requirements

Please be sure that your PC/MAC® complies with the following specifications:

- PC Operating System; Windows® 7, Windows® 8/8.1 and Windows® 10
- PC Browser: IE®8, and above (System requirements for PC Browser are for on-line viewing only)
- MAC Operating System: MAC OS X® 10.9 and above
- MAC Browser: N/A

Please be sure that your mobile device complies with the following specifications:

- Android™: 4.2 and above
- iOS®: 9 and above

THIS MANUAL WAS ACCURATE AT THE TIME IT WAS COMPLETED. DUE TO OUR ONGOING EFFORT TO CONSTANTLY IMPROVE OUR PRODUCTS, SPECIFICATIONS MAY HAVE BEEN ADDED OR CHANGED.

4.2 Package Contents

DISCLAIMER: Package contents vary by model number, please refer to your Quick Setup Guide for a complete list of contents.



DVR



Camera(s)



DVR Power Adapter (x1)



Camera Power Adapter(s)
(1 per 4 cameras)



60 ft. Video/Power Cables
(1 cable per camera)



Power Splitter(s)
(1 per 4 cameras)



6 ft. HDMI (x1)



6 ft. Ethernet (x1)

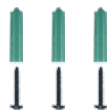

Mounting Hardware



Safety Stickers



USB Mouse (x1)



NOTE: For best results, use the included Night Owl accessories. Third party accessories may not work properly.

4.2.1 DVR Diagram

Once you have downloaded Night Owl X or Night Owl X HD and connected your DVR to your router, you can network your DVR by scanning the QR code which is located on the top of the DVR.

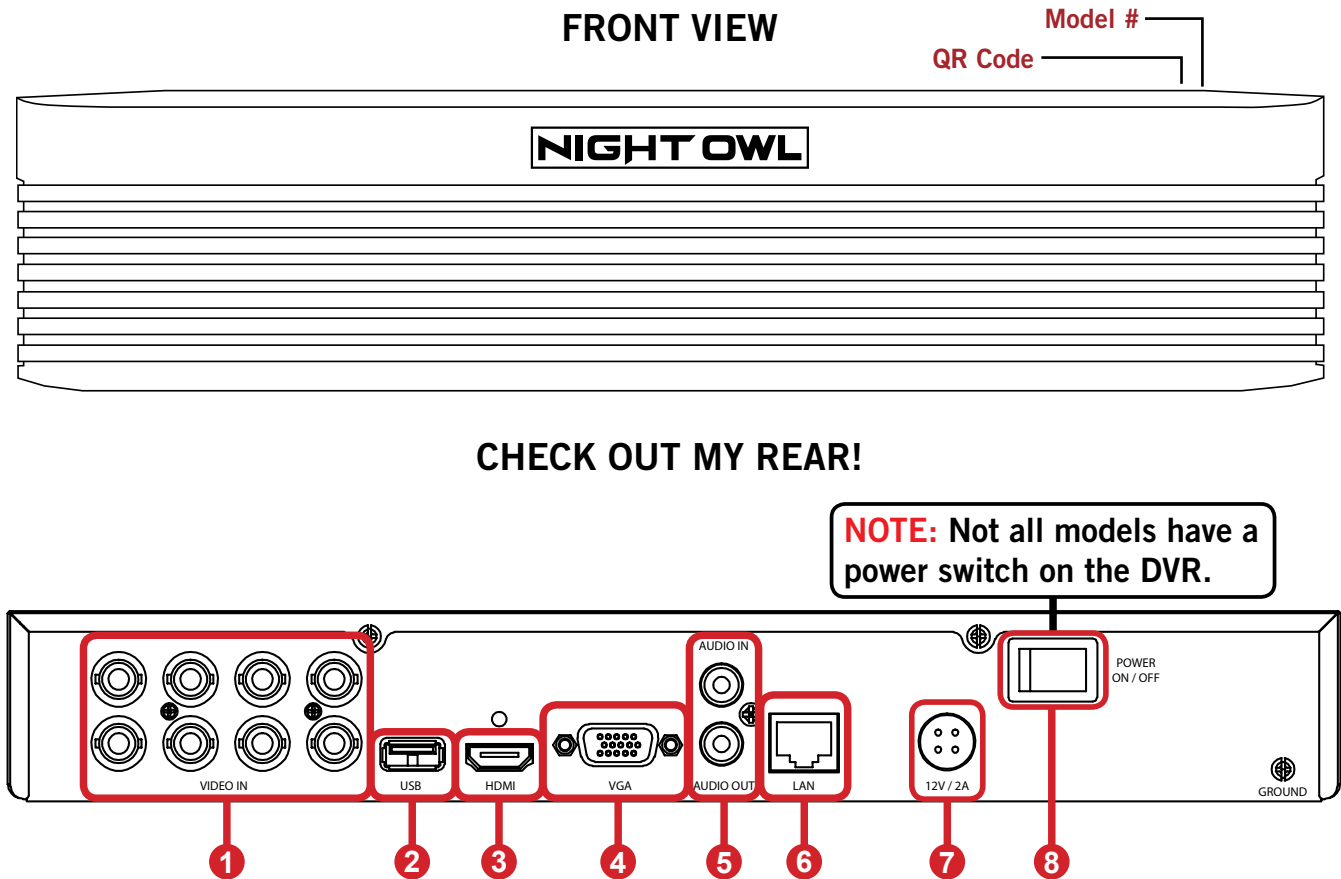

Images used are for reference only. Your product may vary slightly. An 8 channel model is displayed above.

- 1 Video Inputs** – Allow for the connection of BNC cameras.
- 2 USB Ports** – Allows for the connections of a USB mouse and/or a USB flash drive. You will connect the included USB mouse to assist you in navigating the DVR's menu interface. You will connect a USB flash drive to download video files from the DVR and save them to your USB flash drive.
- 3 HDMI Output** – Allows for the video connection. If the TV/Monitor has an HDMI input, connect the HDMI cable from the HDMI output port on the DVR to the HDMI input port on your TV/Monitor.
NOTE: Preferred method.
- 4 VGA Output** – Allows for the video connection. If the TV/Monitor has a VGA input, connect the VGA cable from the VGA output port on the DVR to the VGA input port on your TV/Monitor. *(VGA Cable not included)*
- 5 Audio Inputs & Outputs** – Allows for the connection of audio enabled cameras by connecting the white RCA plug to one of the audio inputs. After making the audio input connection, be sure to enable the audio function in the DVR's menu interface. *(Audio enabled camera, microphone and speaker not included)*
- 6 RJ-45 (Ethernet) Port** – Used to connect the DVR to your router/modem via the included Ethernet cable.
- 7 Power Input** – Used to connect the included 12V DC power supply.
- 8 Power Switch** – Use this switch to power ON/OFF the DVR. Make sure the power switch is in the ON position before attempting to use the DVR.

4.2.2 Camera Diagram

CAMERA

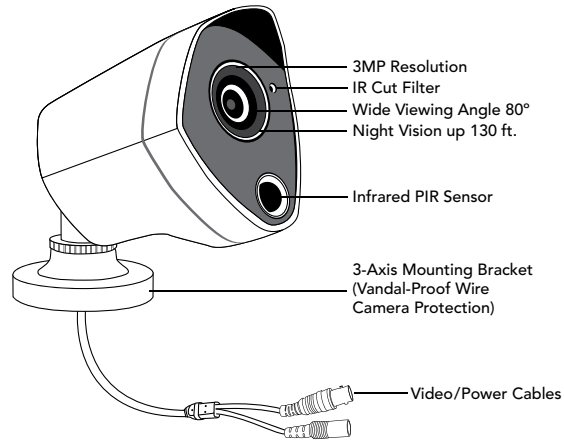

Connect all cameras locally before final placement to ensure that all components function properly.

4.2.3 Mouse Diagram

MOUSE

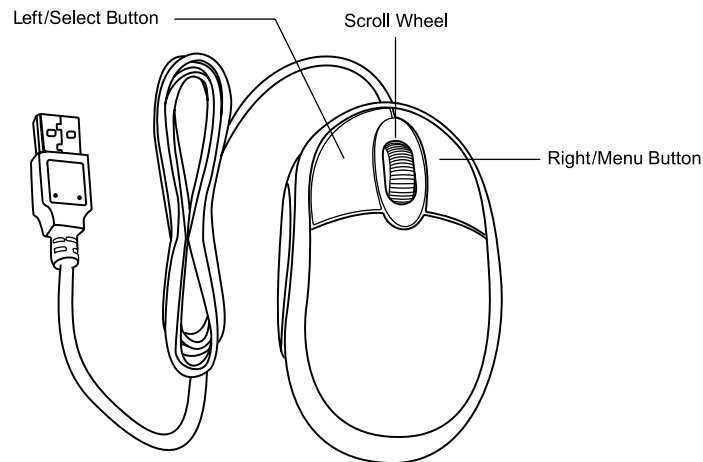

Live Viewing:

Double-click the left button on any camera view in split-screen mode to bring it to full screen display. Double-click again to return to split-screen mode. Right-click to show the Right-Click Menu at the bottom of the screen. Left-clicking hides the Right-Click Menu.

In Setup:

Left-click to make a selection. Right-click to cancel setup or return to previous screen.

To Enter Values:

Move the cursor to a blank field and click the mouse. A virtual keyboard will appear which supports numbers, letters and symbols. The Shift function will access symbols in addition to upper case letters.

The background is dark with a red gradient. It features two large, semi-circular patterns on the left and right sides. Each pattern contains a camera lens at the top and a grid of red circular sensor elements below it. The text is centered in the middle of the page.

CHAPTER 5

CAMERA INSTALLATION

Chapter 5: Camera Installation

5.1 Video/Audio



Connect all cameras locally before final placement to ensure that all components function properly.

- 1 Locate an included 60 foot Video/Power cable.
- 2 Connect a camera to one end of the cable by matching the BNC connectors and DC power connectors.
- 3 Audio enabled cameras (*not included*) will have an additional (white) RCA connection which will transmit the audio signal and will connect to the audio in port on the back of your DVR.

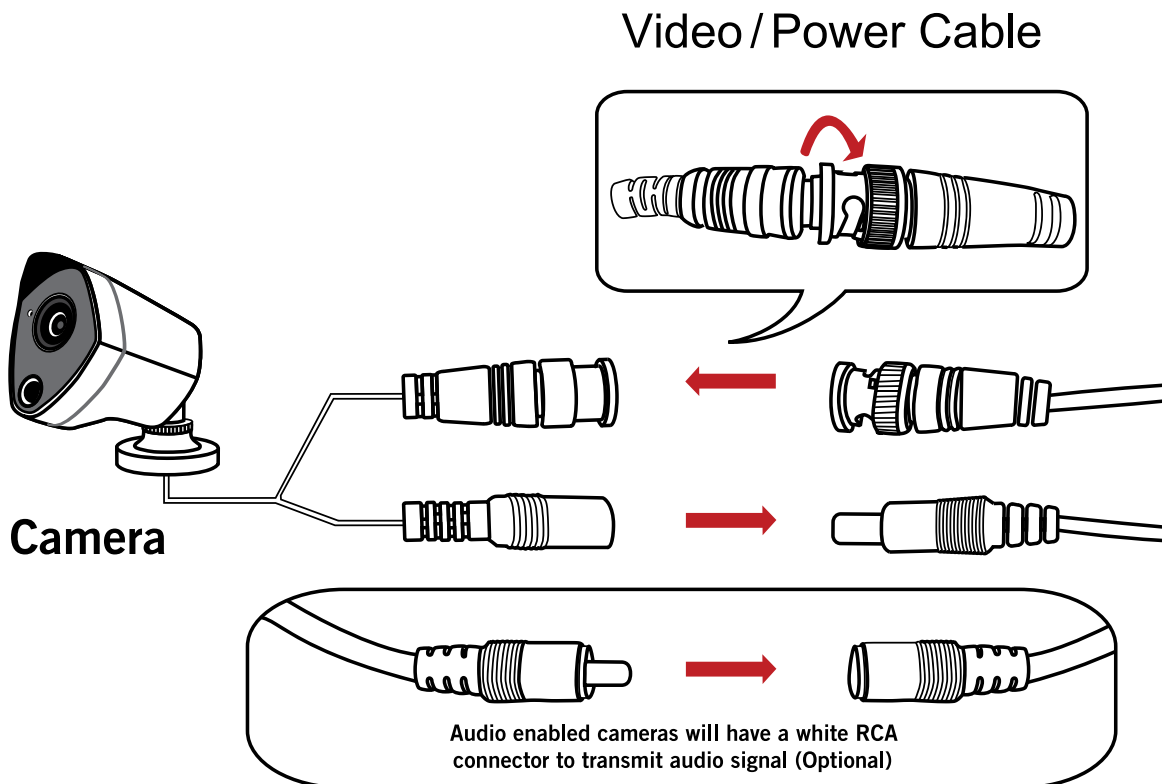

- 4 Plug BNC connectors on the other end of the cable into a Video Input port on the back panel of the DVR.
- 5 Repeat for each camera, noting the channel number each camera is plugged into.

5.2 Power

5.2.1 Standard Camera Power

- 1 Locate an included power splitter.

Power Splitter

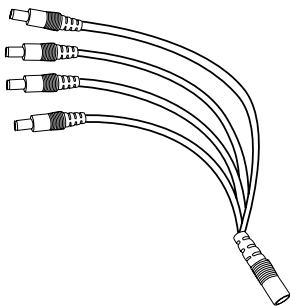

- 2 Connect the power splitter to the remaining DC power connectors (red) of the cables.
- 3 Plug the power splitter into the labeled camera power supply, then plug the camera power supply into an available wall outlet or UPS. Keep in mind, Night Owl always recommends utilizing a surge protector to minimize the risk of damage caused to your DVR in the event of a power surge.

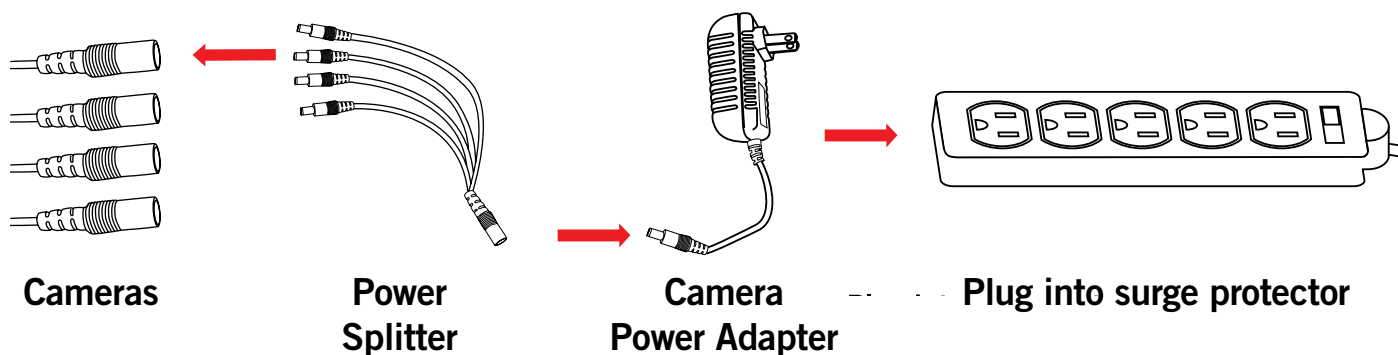

Make sure all cameras are working prior to mounting by connecting them as described in the section above. Once all cameras are confirmed to be fully operational, you can run the cables and mount the cameras at their final locations.

5.3 Mounting the Cameras



Connect all cameras locally before final placement to ensure that all components function properly.

- **Camera distance from DVR.**

The further the camera is from the DVR or monitor, the higher the chances of signal degradation. The camera's power supply should be located as near to the camera as possible when the distance exceeds 200 ft. as the power level will drop over extended distances resulting in video degradation.

- **Do NOT place near high voltage wires or other sources of electrical interference.**

Electrical interference will degrade the quality of the signal.

- **Place camera out of reach to avoid vandalism.**

- **Avoid direct exposure to weather.**

Do not place the camera where rain or snow will hit the lens directly nor should the camera be placed so that the sun or bright light shines directly into the lens. Your camera is weatherproof, but it will not work when submerged in water. Ensure that all power and video connections are not directly exposed to water and are protected from the elements.

- **Mounting surface.**

The mounting surface must hold at least four times the camera's total weight.

Follow these instructions to correctly install your cameras.

- 1 Locate a camera and choose a location where you would like to mount the camera.
- 2 Indicate screw positions by marking three holes on the surface where you plan to mount the camera, using the holes in the camera base as a guide.

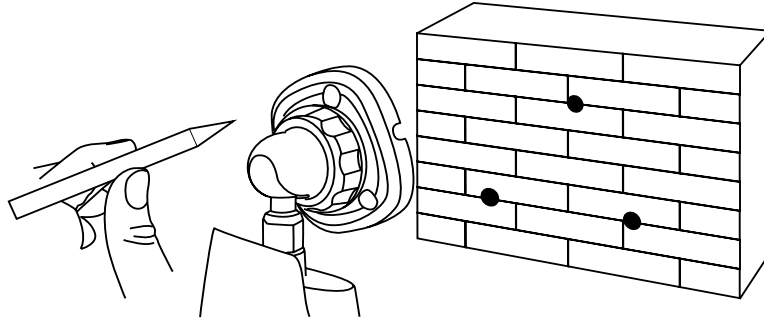

- 3 Using a drill bit slightly smaller than the included screw anchors, drill into the mounting surface using the guide marks you placed in the previous step.
- 4 Insert the screw anchors.
- 5 Line up the camera base holes with the screw anchors. Holding the base in place, insert screws and tighten until secure.

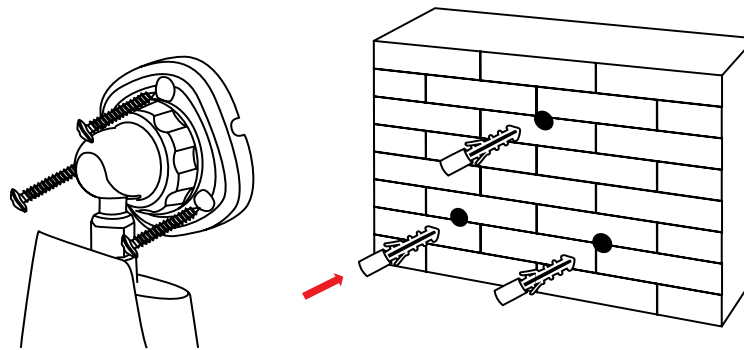

- 6 Once the base is screwed in place, make sure that the camera is securely mounted by placing gentle pressure on the mount.
- 7 Adjust the camera housing to point in the direction of the area you would like to monitor.



CHAPTER 6

DVR INSTALLATION

Chapter 6: DVR Installation

6.1 Connecting to a TV (via HDMI)

- 1 Locate the included HDMI cable.



- 2 Plug one end of the cable into the HDMI port on the back of the DVR.

DVR

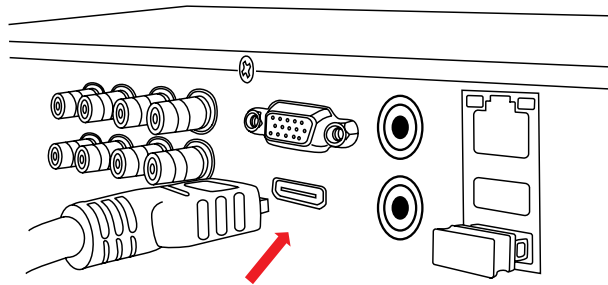

- 3 Connect the other end of the cable to an available HDMI input on your TV or monitor.

Monitor

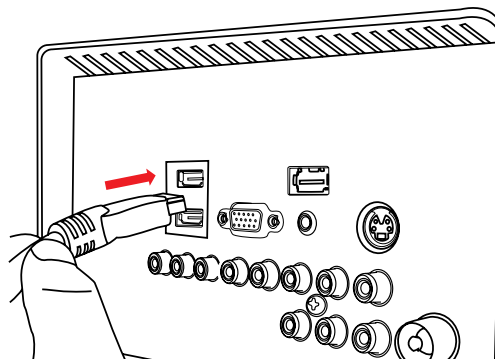

- 4 Select the appropriate video input channel on your TV or monitor to view the DVR.



If your TV does not have an HDMI port, you will need to purchase a VGA video cable. For VGA connection, attach one end of the VGA cable to the DVR VGA port and the other end to your TV VGA port.

6.2 Power

- 1 Locate the labeled DVR power adapter.

NOTE: The camera power adapter and DVR power adapter should never be interchanged.

DVR Power Adapter

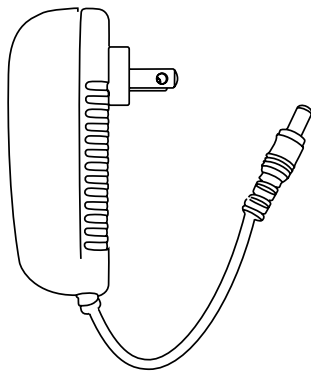

DVR power adapter may vary slightly.

- 2 Plug the included power adapter cable into the back of the DVR.

DVR

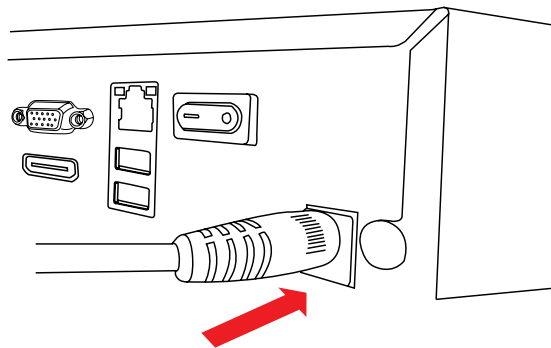

- 3 Plug the other end of the power adapter cable into an available wall outlet. If you are using an uninterruptible power supply (UPS), plug the adapter cable into one of its output sockets. Keep in mind, Night Owl always recommends utilizing a surge protector to minimize the risk of damage caused to your DVR in the event of a power surge.

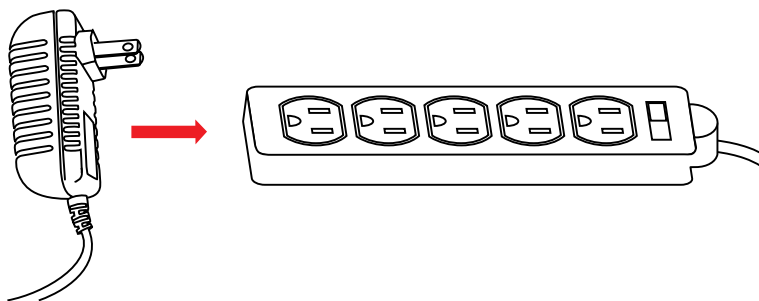



CHAPTER 7

GETTING STARTED

Chapter 7: Getting Started

7.1 Startup Wizard

When your DVR is powered on it will display the Night Owl logo while initializing.



After initialization, you will be prompted to use the Startup Wizard. Follow the on-screen instructions to:

- Complete the basic setup of your DVR.
- Upgrade the firmware.
- Set up the Night Owl X or Night Owl X HD app.
- Configure notifications.
- Test your cameras locally.
- Create an Admin password.
- Configure the recording settings.

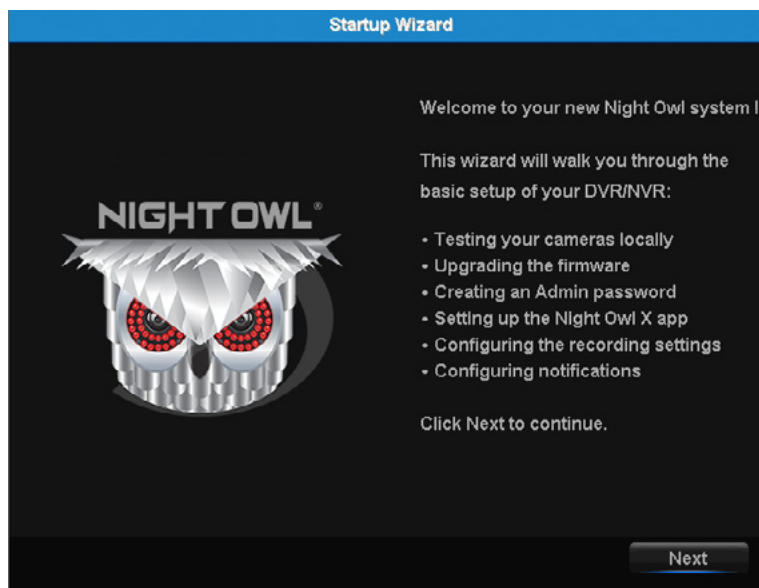

7.1.1 Camera Test

The Camera Test screen of the Startup Wizard serves as a reminder to test the camera connections to the DVR. If a connected camera displays a “No Signal” message, please visit www.NightOwlSP.com and click on the Support tab.

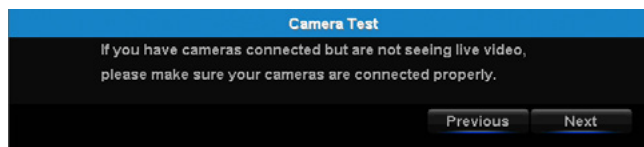
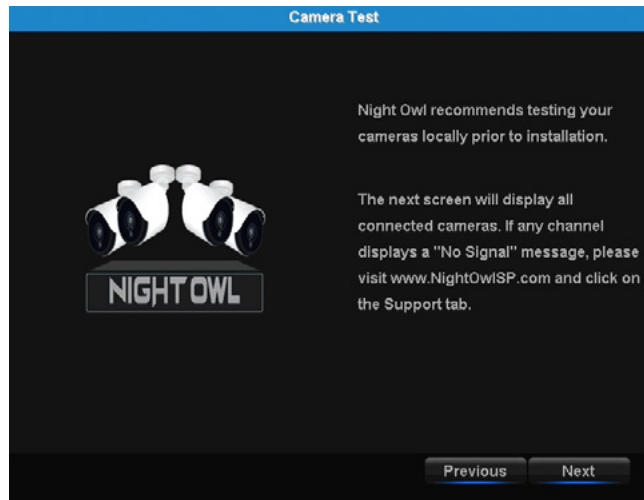

7.1.2 Network Check

The Network Check screen of the Startup Wizard displays instructions for how to connect your DVR to the Internet. You will need the included Ethernet cable to establish connection, your DVR will not be able to wirelessly connect to your router/modem. Once you have made the required connection using the Ethernet cable, you may click Test within the Startup Wizard to confirm Internet connection.

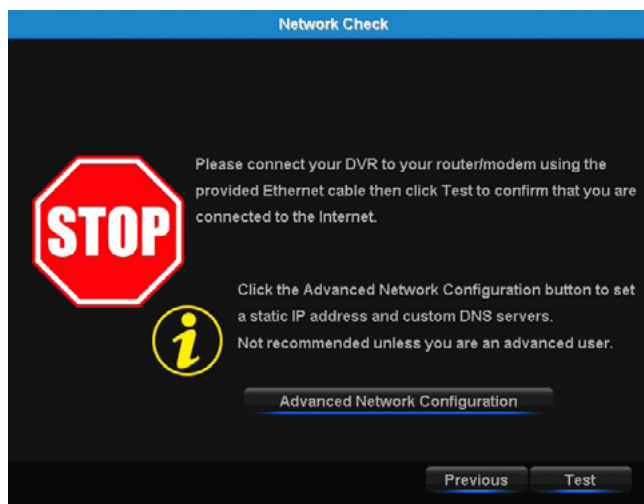

The Advanced Network Configuration tab is recommended only for advanced users.

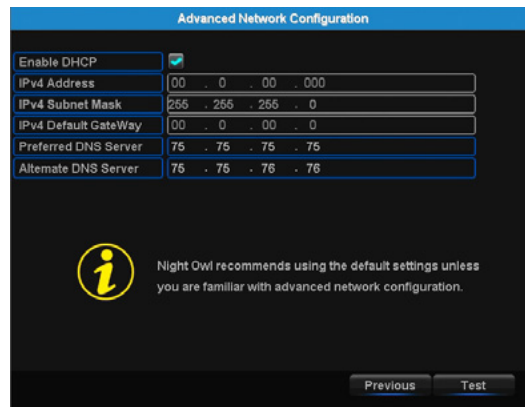

Once the internet connection has been established, the Startup Wizard will display a successful connection screen.

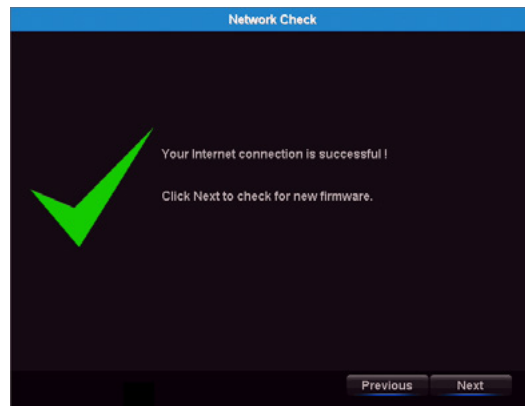

If your DVR is not able to establish Internet connectivity, a Connection Failed screen will appear. Follow the instructions on this screen to re-test the network.

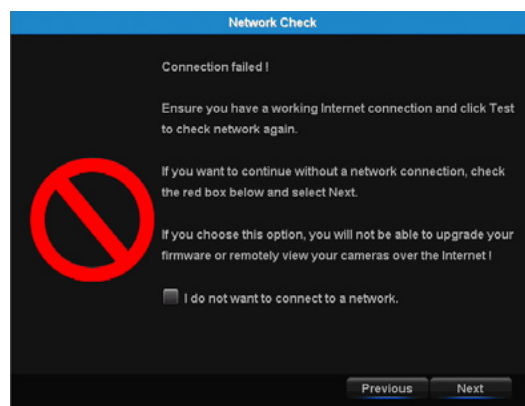

If you wish to proceed with the DVR setup without a network connection, you may do so by clicking the box marked, "I do not want to connect to a network." If you proceed without network connection, you will not be able to upgrade your systems firmware. It is recommended that you complete the initial setup with a secure network connection.

7.1.3 Firmware Check

The Firmware Check screen of the Startup Wizard will automatically check for a firmware update. The Startup Wizard will notify you if a firmware upgrade alert is detected. Please select “Update” to download and install the latest firmware available for your system. The DVR will restart automatically when the update is complete. This may take up to 10 minutes, please be patient. If you have chosen to complete the DVR setup without Internet connection, the screen below will not appear. The Startup Wizard will automatically jump to the password creation screen (overview on page 30).

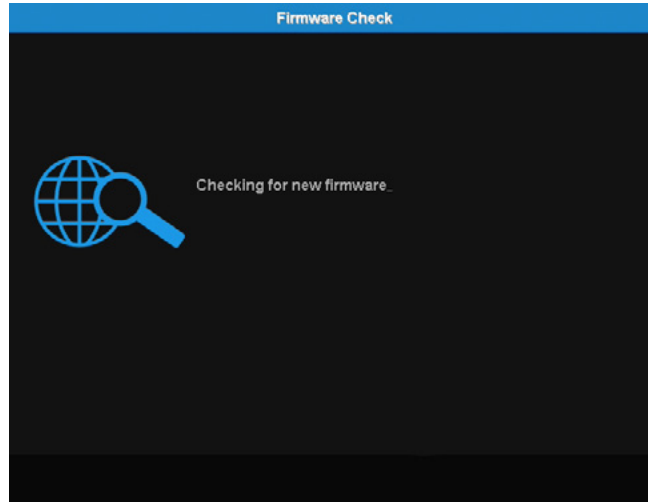

NOTE: Do NOT turn off your DVR or disconnect it from the Internet while the system is upgrading.

When the firmware for your DVR is updated to the most current version, the Startup Wizard will display the below screen.

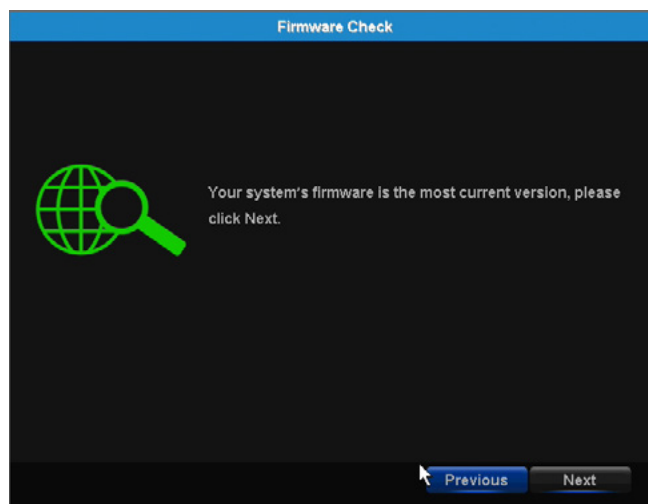

7.1.4 Password Creation

The Password Creation screen of the Startup Wizard requires you to create an admin password for your DVR system. Night Owl strongly suggests that you write down your admin password on page 5 of the Quick Setup Guide of your DVR, as you will be required to log in any time you want to configure or adjust your system settings.

This screen will also require that you set a recovery email address in the event that your admin password is forgotten.

Admin Password

New Admin Password

New Password

Confirm Password

Password Reset Email yourname@youreemail.com

To begin configuring your Night Owl system, please create an Admin password.

password can be any alphanumeric characters between 6 and 20 characters.

Night Owl recommends that you write down your password and store it in a secure location. Include a recovery email so you can reset your password if you lose or forget it.

User name will be 'admin'. You can add more users after completing the Startup Wizard.

? Forget PWD Previous Next

NOTE: You will not be able to complete the Startup Wizard unless a recovery email address is established. To change your recovery email address, you MUST rerun the Startup Wizard.

Simply click on the text box to open the on-screen keyboard. Use this keyboard to create your Admin password and to input your recovery email address. If you have forgotten your Admin password, simply click on the Forgot Password tab in the Startup Wizard and a Secure Code will be sent to your recovery email address. Use the Secure Code to restart your DVR and create a new password.

Admin Password

New Admin Password

New Password

Confirm Password

Password Reset Email yourname@youreemail.com

To begin configuring your Night Owl system, please create an Admin password.

password can be any alphanumeric characters between 6 and 20 characters.

Night Owl recommends that you write down your password and store it in a secure location. Include a recovery email so you can reset your password if you lose or forget it.

User name will be 'admin'. You can add more users after completing the Startup Wizard.

? Forget PWD? Previous Next

NOTE: Forgot the admin password? Click the "Forgot PWD?" tab in the Startup Wizard and a Secure Code will be sent to your recovery email address. Restart the DVR and enter the Secure Code when prompted. Create a new password for the DVR.

7.1.5 Date and Time Setup

The Date and Time Setup screen of the Startup Wizard will allow you to set the current date and time. You may choose to use Network Time Protocol (NTP) to auto-configure the current date and time.

NOTE: You must be connected to the Internet to use NTP.

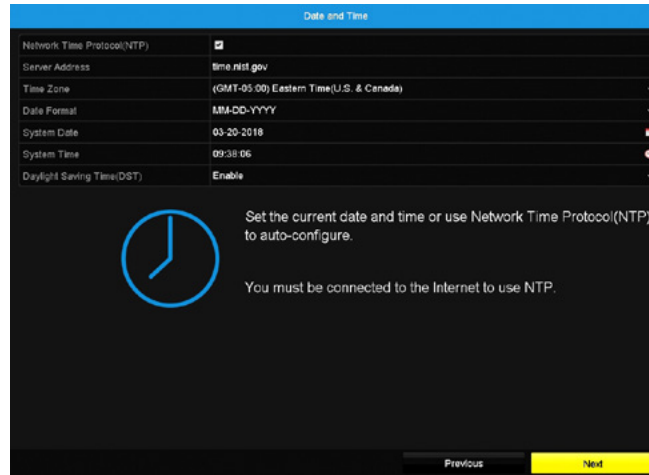

7.1.6 Night Owl Apps

The Night Owl Startup Wizard gives you information on where to find the Night Owl X app and how it can be used to remotely view your DVR recordings and live stream.

NOTE: The screenshot below is for the Night Owl X app Setup which is specifically designed for Smartphones. Please download the Night Owl X HD app if you are using a Tablet.

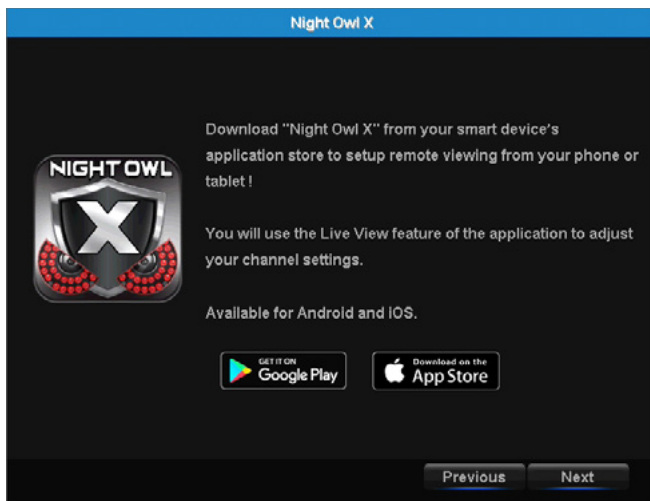

**Specifically
Designed for
Tablets**

Once you have installed the Night Owl X or Night Owl X HD app on your smart device and created an account, you can scan the QR code on the Startup Wizard to configure your DVR with the Night Owl X or Night Owl X HD app!

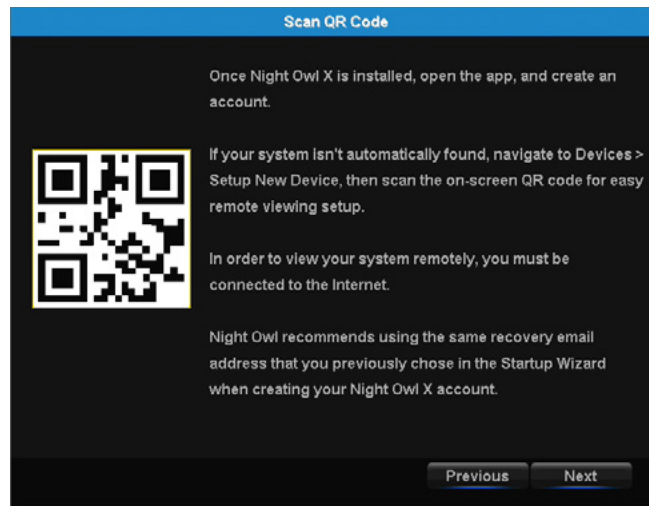

NOTE: In order to view your system remotely, your DVR must be connected to the Internet.

Please follow the next steps for creating and using your Night Owl X or Night Owl X HD account.

7.1.6 (a) Using Night Owl X and Night Owl X HD

Download and Install Application

- 1 Download the appropriate app from the *App Store* or *Google Play Store* and install the application on your device.



NOTE: Use correct app for compatibility.



Smartphone:
Night Owl X



Tablet:
Night Owl X HD

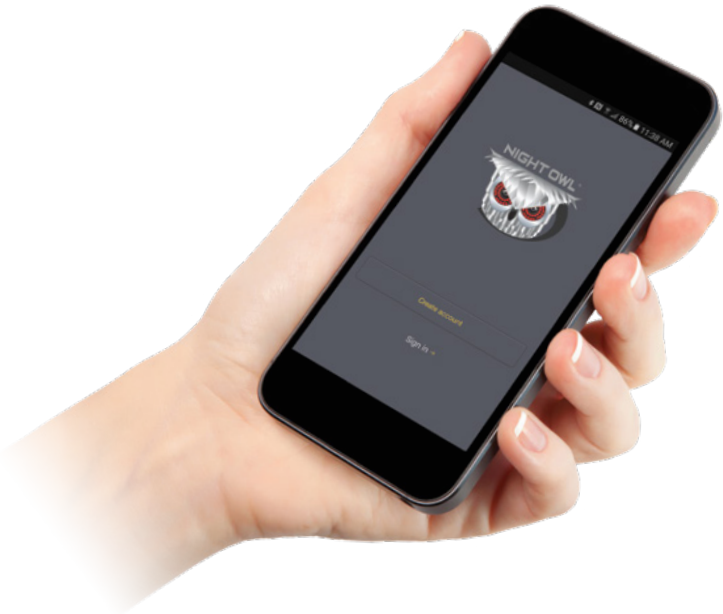
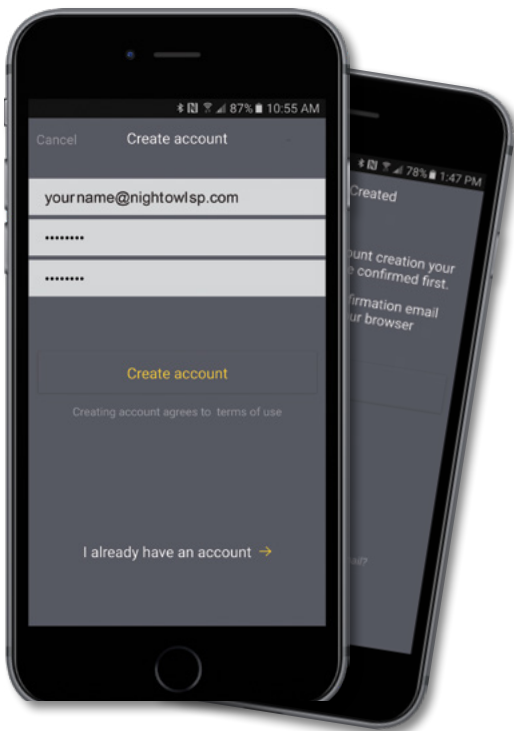

NOTE: Account setup is the same for phone and tablet.

- 2 Create an account using an email address for the username and a password between 6–20 characters. This account allows the user to login to multiple Night Owl devices.

Please note, this is **NOT** the login info created for the DVR, this login is unique to the Night Owl X and Night Owl X HD apps. The DVR login should be stored on page 5, step #2 of the Quick Setup Guide included in your DVR kit.

- 3 To confirm your email address, click the link in the confirmation email from “Night Owl (no_reply@NightOwlsp.com)”.



You **MUST** complete Step 3 before continuing! Go to your email, open the confirmation email from Night Owl, and click the “Confirm Email” link. You **MUST** confirm your email to use the app!

Connecting and Adding your Device

NOTE: When adding a new device, it may take 5–10 minutes before you begin receiving notifications.

A device can be added to the Night Owl X app by using the application's **Smart Auto Detection** or through a **QR Code Setup**. With Smart Auto Detection, your DVR will automatically be detected by the Night Owl X software, making connecting easy! To use this preferred method, ensure your Smart Device and DVR are both on the same network.



4 Adding a Device

To begin adding a new device, first select the yellow plus sign within the Device menu.

4A Smart Auto Detection

If your Smart Device and DVR are on the same network, the Smart Auto Detection will auto find your DVR. If this method is not available, please use the QR Code Setup from step 4B below.

4B QR Code Setup

To use the QR Code Setup, select Setup device by QR Code and hover your Smart Device camera lens over the QR Code located on the top of your DVR.

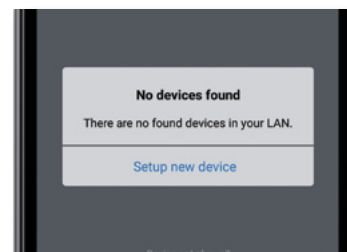
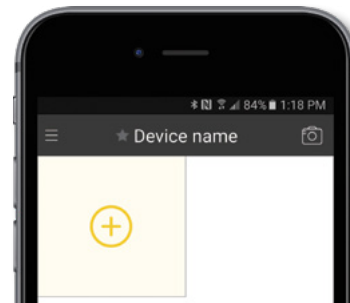

Login to your App

- 5 On the Device Login screen, enter the login information for the DVR (Remember, the DVR login and Night Owl X app login are different). The DVR username is **admin** by default. If you are not the **admin**, login with your username credentials. If you do not have a username and password, please contact the **admin** and have them create one for you using the instructions on page 7 of your QSG.

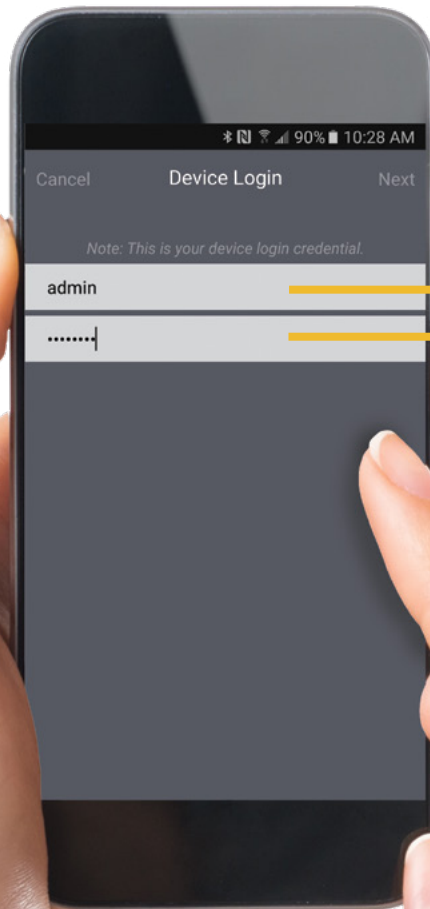

admin is case sensitive
(all lowercase).

NOTE: This is the password of your DVR, NOT the password used to login to the Night Owl X or Night Owl X HD app.

If you are the **admin**, the password will be the same password you created during the Startup Wizard and should be stored on page 5 of your Quick Setup Guide included in your DVR kit. If you are a user, it will be the password you use to login to the DVR.

7.1.6 (b) App Overview

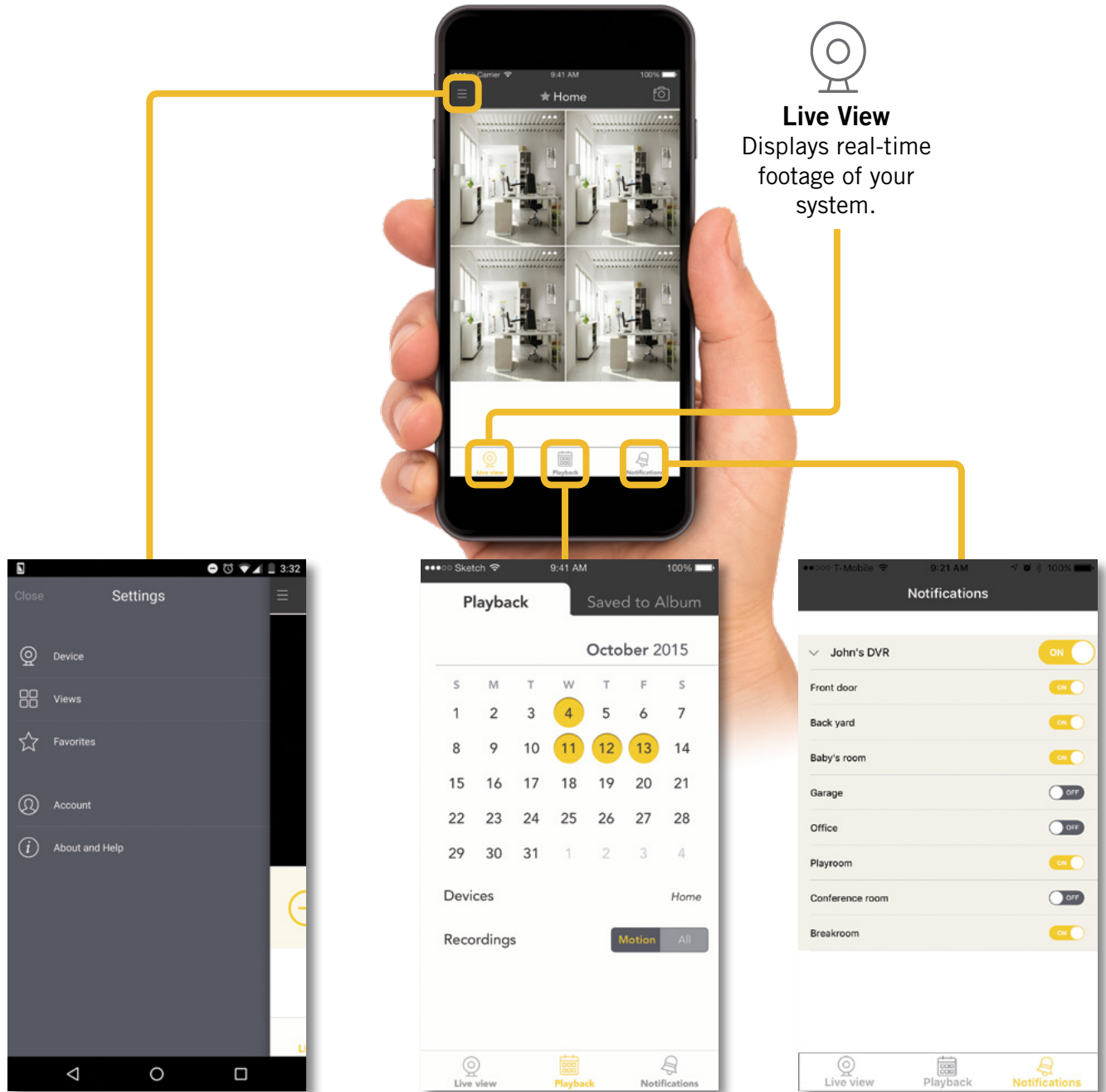

Live View
Displays real-time
footage of your
system.

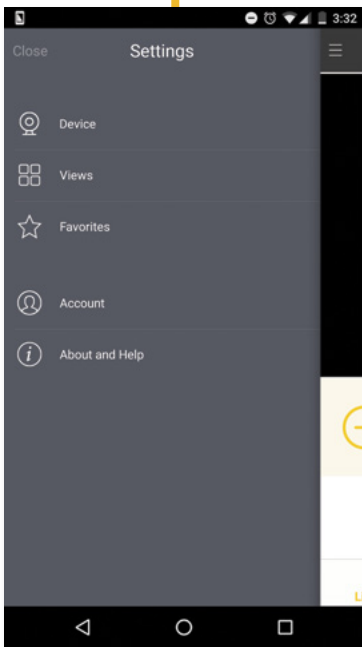

Settings

Display connected devices, change view layout, view favorites, manage accounts and access the help section.

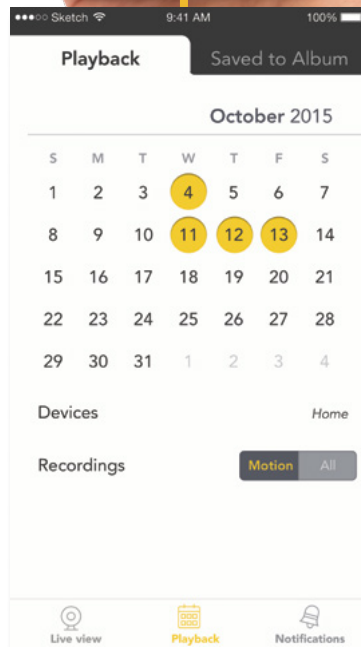

Playback

View recordings & images and save them to your phone's album.

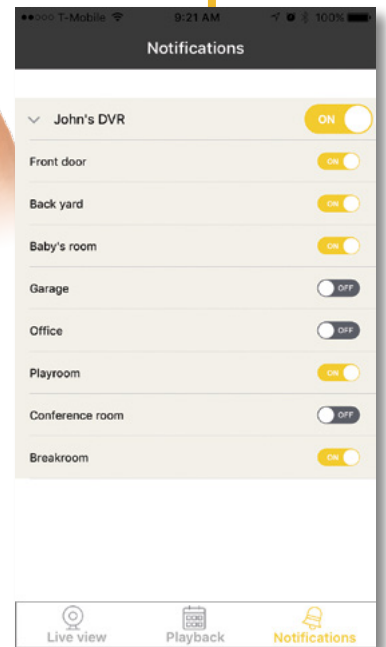

Notifications

Manage custom Push Notifications.

7.1.7 Password Verification

The Password Verification screen of the Startup Wizard will display your Admin password. Night Owl strongly recommends writing down your password within the Quick Setup Guide of your DVR.

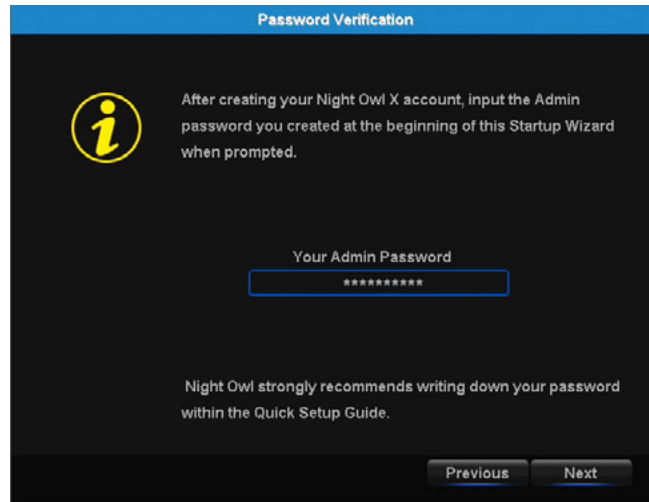

7.1.8 Camera/Channel Settings

The Camera/Channel Settings screen of the Startup Wizard serves as a reminder to mount your system's cameras in the final position so you can make accurate adjustments to positioning, detection area and channel sensitivity.

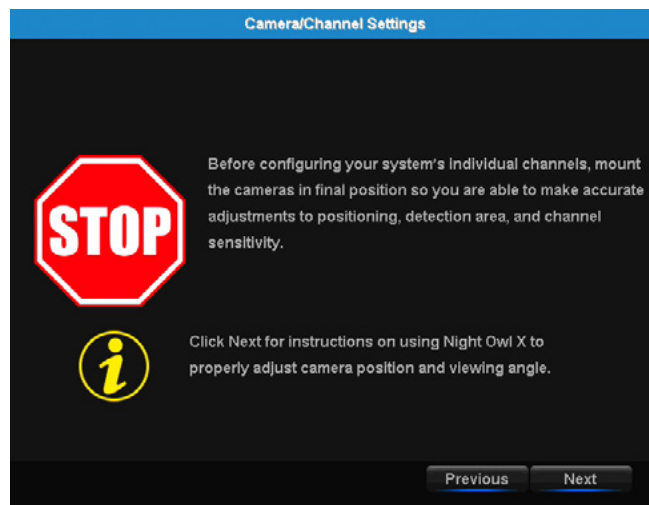

7.1.9 Camera Adjustment

The Camera Adjustment screen of the Startup Wizard shows how you can use the Live View feature of the Night Owl X or Night Owl X HD app to easily adjust your cameras' position and viewing angle.

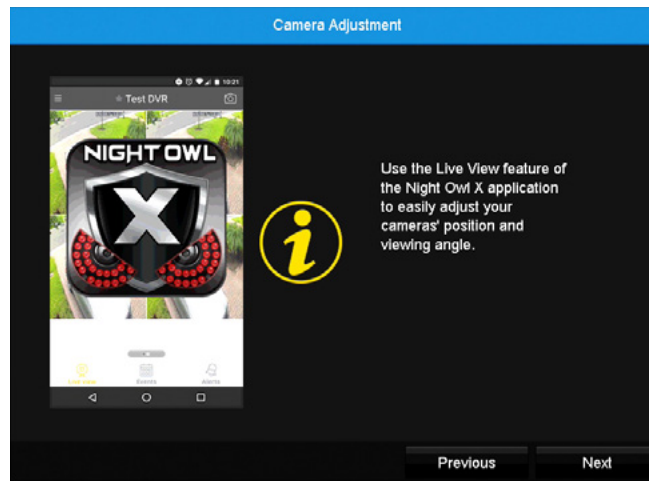

7.1.10 Channel Settings

The Channel Settings screen of the Startup Wizard explains in detail how you will configure your Channel Settings.

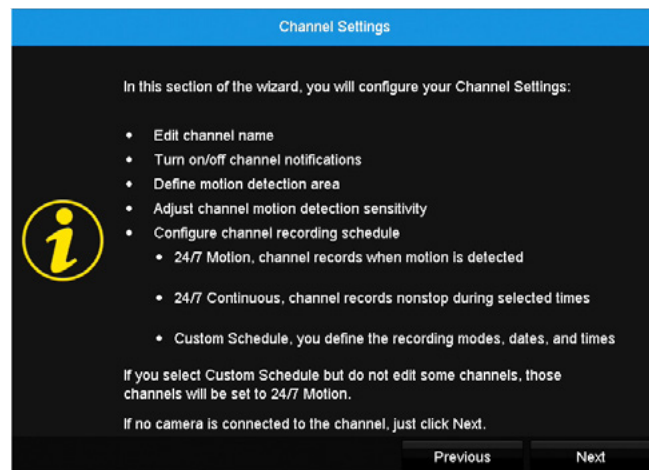

The Channel Settings screen of the Startup Wizard explains in detail how you will configure your Channel Settings.

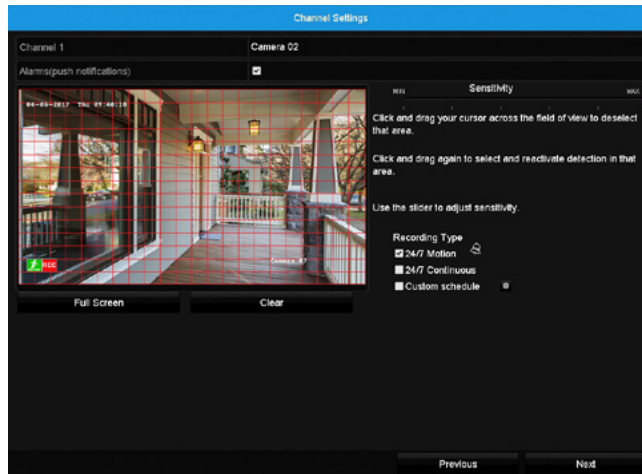

7.1.11 Default View

The Default View screen of the Startup Wizard allows you to select the default view of the monitor connected to your DVR. You may select several viewing options from the drop-down menu:

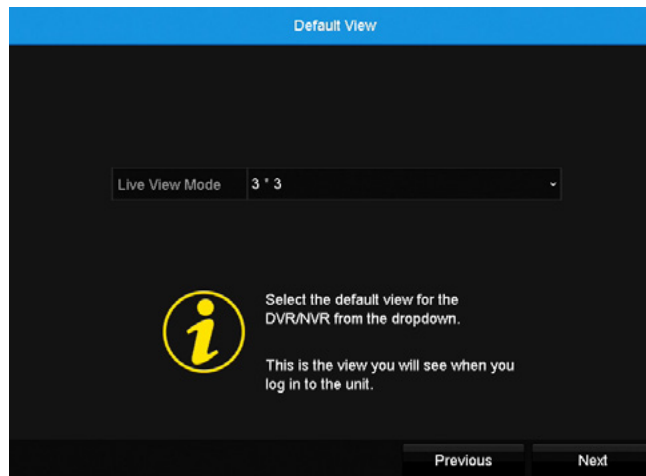

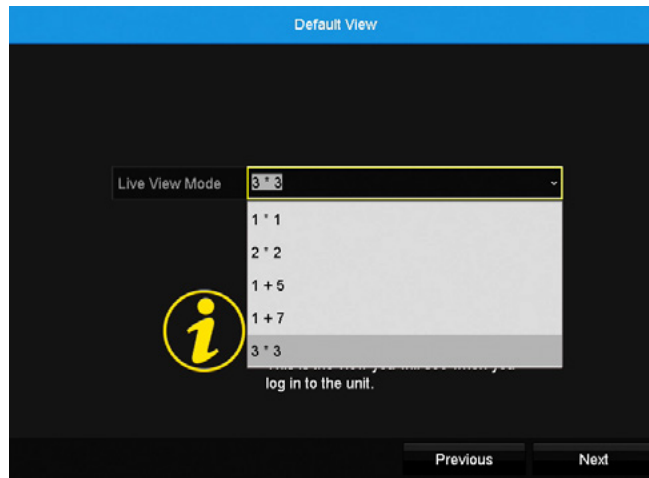

- **Live View:** 1*1 channels onscreen
- **Live View:** 2*2 channels onscreen
- **Live View:** 1+5 channels onscreen
- **Live View:** 1+7 channels onscreen
- **Live View:** 3*3 channels onscreen

7.1.12 Helpful Links

NOTE: Please scan these QR Codes directly from your TV/Monitor, NOT directly from this page.

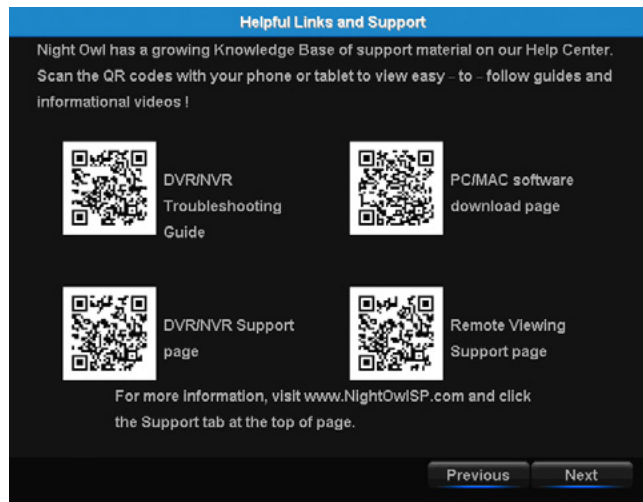

The Helpful Links and Support screen of the Startup Wizard contains QR codes linked to:

- DVR Troubleshooting Guide
- PC/MAC® software download page
- DVR Support page
- Remote Viewing Support page

For more information, visit www.NightOwlSP.com and click the Support tab at the top of the page.

7.1.13 Wizard Complete

Once you have successfully completed the Startup Wizard, click Finish to begin using your Night Owl DVR.

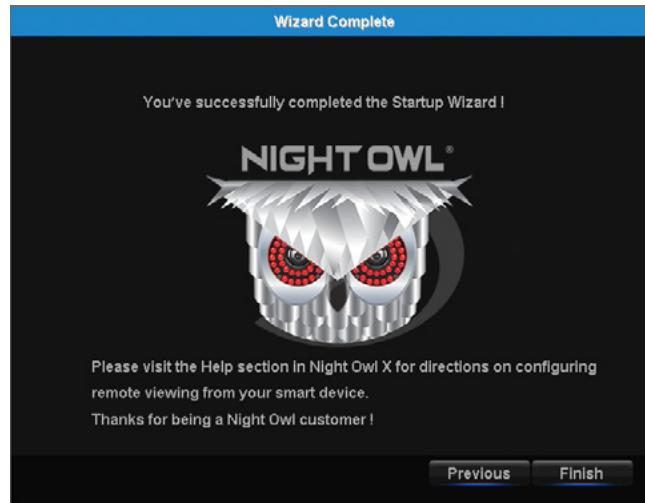

7.2 Displays and Icons

The following sections will describe the main screens you will access for login, playback, recording and configuration.

7.2.1 Live View (All Channels)

After you have completed the initial setup of your DVR through the Startup Wizard, whenever you power on your DVR, the first thing you will see is the Live View screen. Live View is the default display mode of your DVR. It is where you can watch live images from your cameras and access the DVR Menu. Read through this section to learn about the Live View status icons and how to control and manage your DVR using the Channel Toolbar and Mouse Menu.

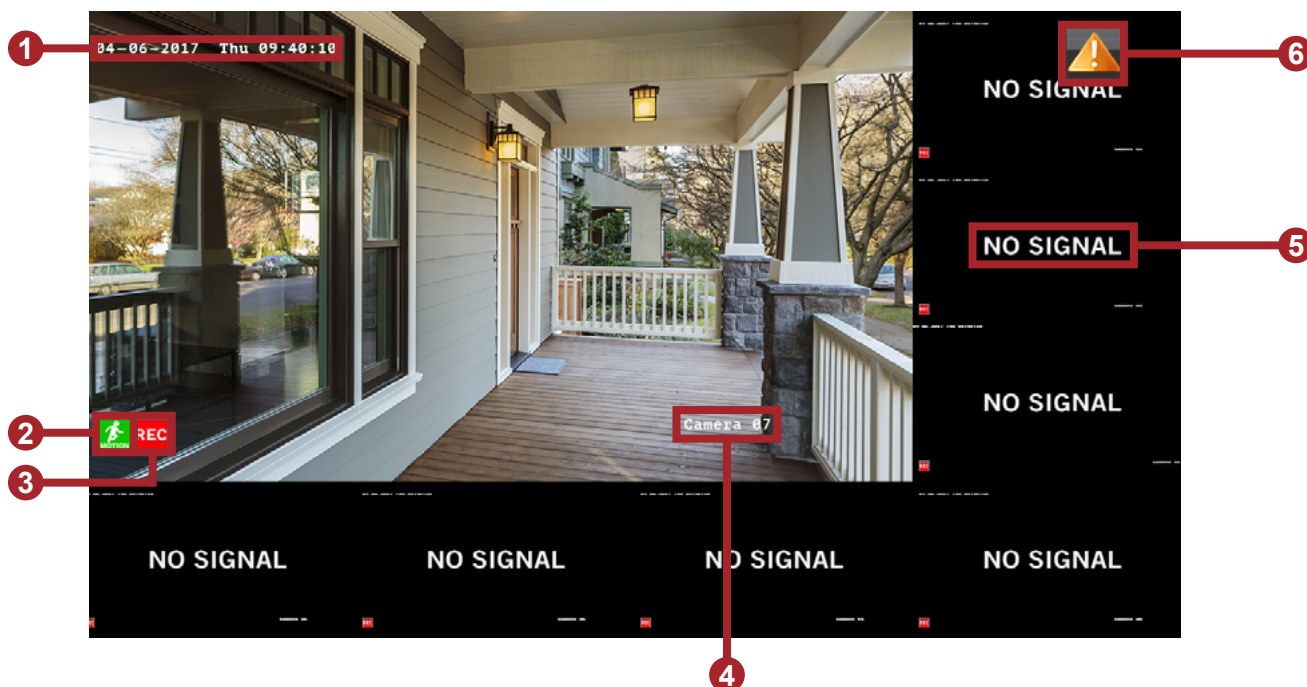

- 1 Time OSD:** Current time of your DVR.
- 2 Motion Detection Icon:** Indicates that an alarm event such as motion detection, video loss or tampering has occurred.
- 3 DVR Status Recording Icon:** Indicates that your DVR is currently recording video from this camera. This icon will be the same whether the recording was scheduled, initiated manually or triggered by motion.
- 4 Camera Name OSD:** Current name of each Camera/Channel.
- 5 No Signal Icon:** Indicates that the specific channel has lost the feed from the corresponding camera. This may be caused by a disconnected/damaged cable, the camera may have lost power or the camera may have been de-registered from the channel. This also appears if you do not have a camera connected to the channel.
- 6 System Exception Icon:** Indicates that an alarm event or exception has occurred. Click the icon to access the Alarm/Exception Information log where you can find specific details about the event.

7.2.2 Right-Click Menu

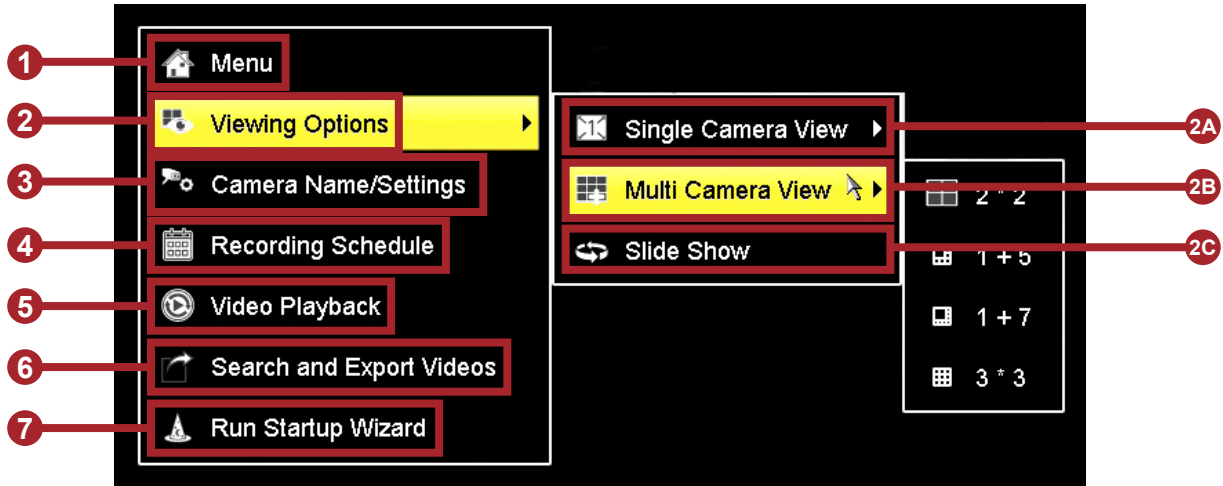

- 1 **Menu:** Open the Main Menu.
- 2 **Viewing Options:** Manually locks or unlocks screen. Once the screen is locked, you will need to enter your username and password to gain access.
 - 2A **Single Camera View:** Open a single channel for viewing in full-screen mode. The slide-out menu contains a list of channels to choose from.
 - 2B **Multi Camera View:** Select a multi-screen viewing option, where you will be able to see multiple video feeds at once.
 - 2C **Slide Show:** Turn on sequence mode to automatically switch view between channels at specific intervals.
- 3 **Camera Name/Settings:** Open the Camera Management Section to configure various camera settings such as on screen display information, motion detection, privacy mask and more.
- 4 **Recording Schedule:** Open the record menu to set up recording schedules for the cameras and customize how your DVR records footage and “encodes” the files.
- 5 **Video Playback:** Open the Video Playback.
- 6 **Search and Export Videos:** Open the Search/Export menu to Copy or backup footage from your DVR. You will need a compatible USB Flash Drive to store the data (FAT32 file format only).

NOTE: Before exporting a video file, the external USB flash drive or memory stick MUST be in FAT32 or NTFS file format.

- 7 **Run Startup Wizard:** Open startup wizard.

7.2.3 Channel Toolbar

The Channel Toolbar is a 'shortcut' to commonly used DVR functions which you can use to operate a particular channel. Whether you want to playback recordings, zoom in on the image or just adjust the camera's image settings, the Channel Toolbar is a quick and convenient way to keep up with what is happening on your cameras.

To open the Channel Toolbar, simply left-click on the channel you would like to operate.

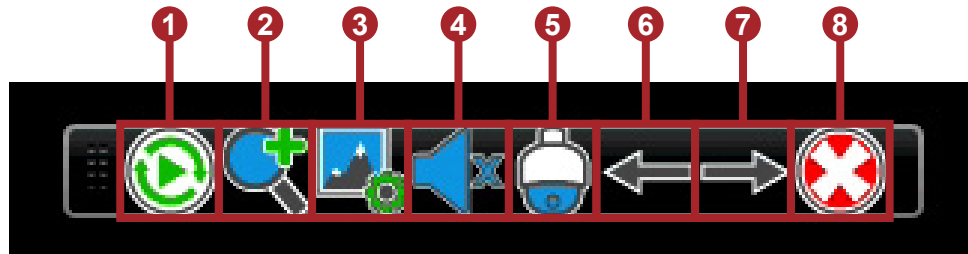

- 1 **Instant Playback:** Playback the last 5 minutes of recorded video.
- 2 **Digital Zoom:** Enter Digital Zoom mode. Use the PIP (Picture-in- Picture) screen at the bottom right corner to zoom in on a different selected area. You can also click and drag to draw a specific zoom in area.
- 3 **Image Settings:** Adjust brightness, contrast, saturation, sharpness and de-noising, hue and on screen display preferences, or select from one of the preset image modes.
- 4 **Audio:** *Enable* or *Disable* live audio.
- 5 **PTZ Control:** Display the control panel to operate a PTZ camera that is connected and configured with your DVR.
- 6 **Previous Screen:** Display the previous set of channels(s).
- 7 **Next Screen:** Display the next set of channels(s).
- 8 **Close:** Close the toolbar.

7.2.4 Login

Any time you want to configure or adjust your system settings you will be required to log in by entering your username and password. It is important you save your login information or you will not be able to access your DVR. Be sure to store your username and password in a safe location (Night Owl suggests page 5 of your QSG). You will need this information to access the main menu.

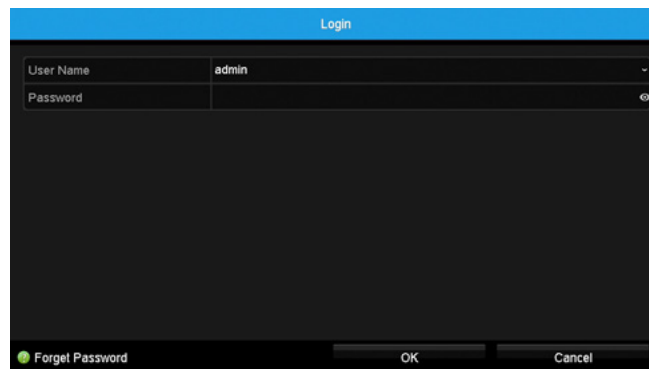

User: Enter the username you created in the Startup Wizard or User Menu.

Password: Enter the Password you created in the Startup Wizard or User Menu. If the password is incorrect you will be prompted to try again. Keep in mind the password is case sensitive and must be between 6 and 24 characters long.

Forgot Password: Sends a secure code to your recovery email. Once you input the secure code, your DVR will restart and you will be able to create a new password.

NOTE: If you have forgotten your Admin password, simply click on the “Forgot PWD” tab and a Secure Code will be sent to your recovery email address. Use the Secure Code to restart your DVR and create a new password.

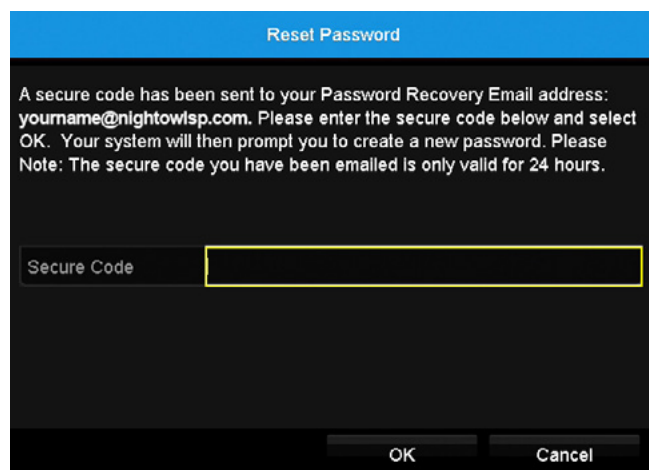



CHAPTER 8

MENUS AND SETTINGS

Chapter 8: Menus and Settings

Some menu screens will allow you to copy similar settings to multiple channels. Choose the channel you would like to copy information from in the first dropdown box (Copy), then select the channel you would like to copy the information to from the second dropdown box (To). Click Copy when the proper channels have been chosen.

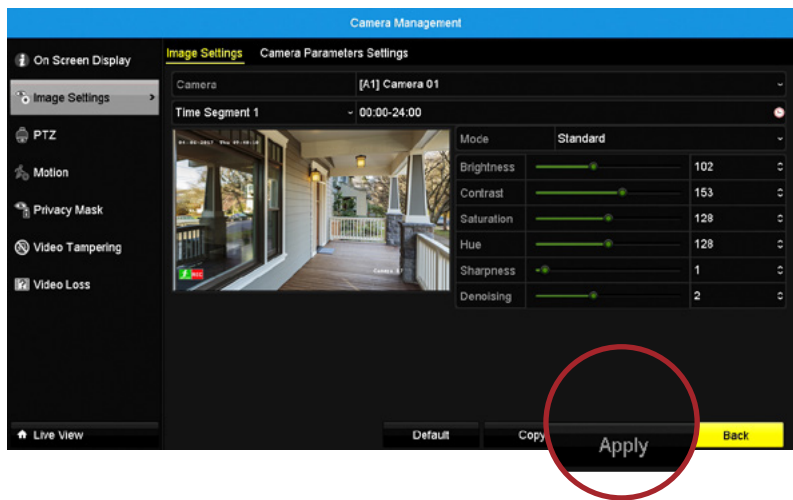
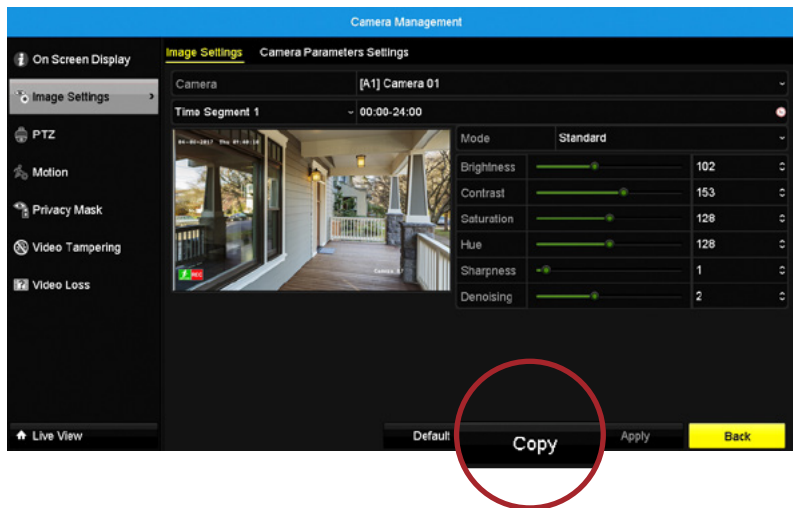

Be sure to click **Apply** to save all changes you make in the menus. If you do not save the changes, they will not be applied. You can also select the **Default** button on any page to restore default settings for those parameters.

Menu

The main menu lets you access many of your DVR's great features. You can customize camera names, keep track of recent events, create recording schedules, configure advanced motion detection settings, check up on the hard drive's condition and change other DVR settings.

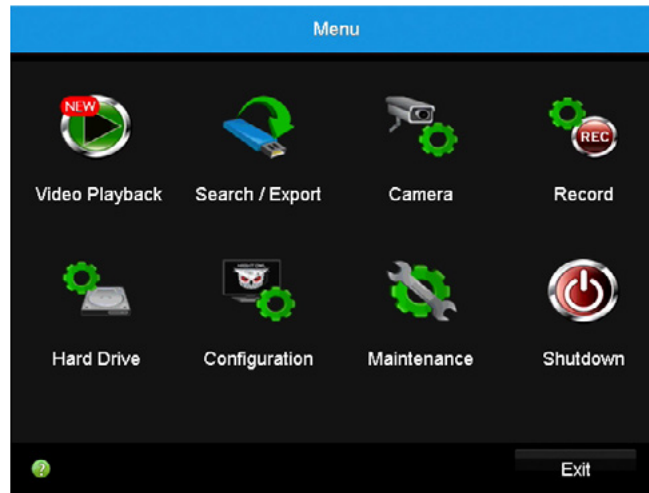

Video Playback: Search and watch all video recordings by channel, type of recording, date or time period.

Search/Export: Copy or backup footage from the DVR. You'll need a compatible USB Flash Drive to store the data (FAT32 file format only).

Camera: Configure various camera settings such as on screen display information, motion detection, privacy mask and more.

Record: Set up recording schedules for the cameras and customize how the DVR records footage and "encodes" the files.

Hard Drive: Check on the status of your DVR's installed hard drive and adjust the settings.

Configuration: Access general DVR system settings, including date and time, network, live view display, exception handling and user accounts.

Maintenance: Find general information about your DVR system. This is also where you can perform various system maintenance tasks including upgrading your DVR's firmware, resetting your DVR to its default settings and running hard drive diagnostic tests.

Shutdown: Shut down or reboot the DVR, or simply log out of the user account. To ensure the integrity of your data and recordings, always select Shutdown when powering off the DVR.

8.1 Video Playback

The Video Playback menu allows you to search your DVR's Hard Drive for recorded video. You may view, tag and export video clips from within this menu.

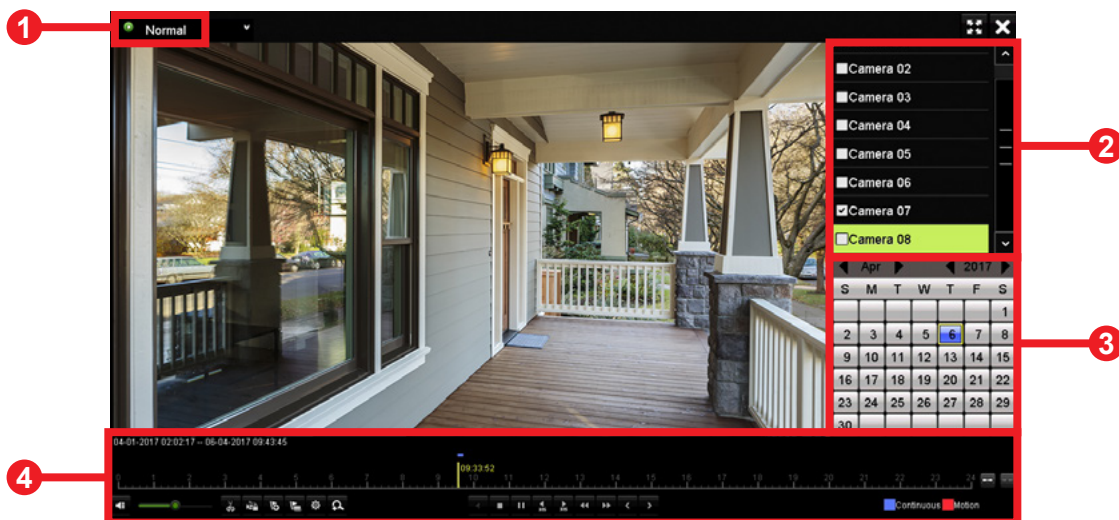

- 1 Playback Type:** Choose which video recordings to playback. Options are: Normal (i.e, Motion and Continuous, Event, Tag, Smart, Sub-periods and External File.)
- 2 Camera Selection:** Search for recordings from one or more cameras.
- 3 Calendar:** Appears when you select Normal playback. Highlighted dates indicate recordings are available for viewing on these days from the selected cameras.
- 4 Video Playback Control Panel:** Set up recording schedules for the cameras and customize how the DVR records footage and “encodes” the files.

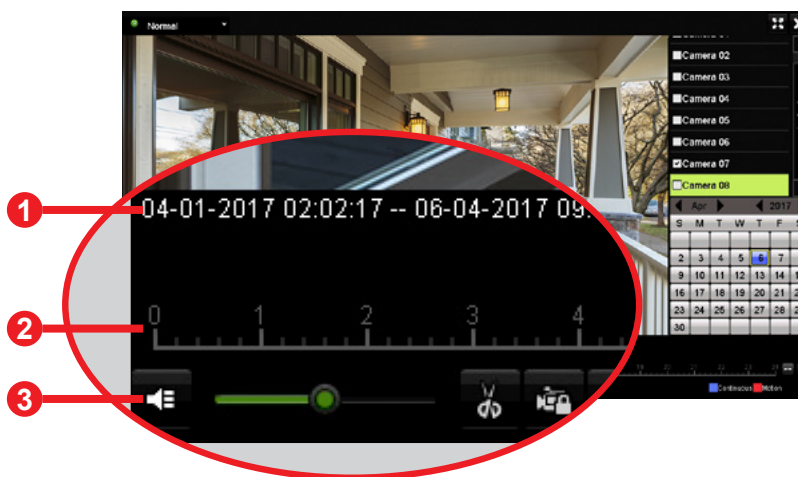

- 1 Normal Playback:** Indicates the start time of the first available video recording and the end time of the last video recording made.
- 2 Video Timeline:** Click any point of the video timeline to quickly scan through video events.
- 3 Mute:** Turn off sound from the video.



- 4 **Start/Stop Clipping:** Clip interesting parts of the recorded video by setting the mark in and mark out points on the video recording. When a video file is playing, click the Start Clipping button at the mark in point and click it again at the mark out point. Multiple mark in and mark out points can be applied.
- 5 **Lock File:** This feature allows you to lock clips on the DVR, preventing them from being overwritten.
- 6 **Add Default Tag:** Tags are descriptive keywords you can add to your video at certain time positions to record information such as people or activity. By adding tags, you can easily find the video content that you want to view. Click this button to add a default tag called TAG. To add a customized tag, click the Add Customized Tag button on the right of this button. You can add up to 64 tags on a single video.
- 7 **Add Customized Tag:** Enter a name for the tag you are adding.
- 8 **File Management:** Allows you to manage or export blocked and tagged video clips.
- 9 **Zoom In:** Enter Digital Zoom mode. Use the PIP (Picture-in-Picture) screen at the bottom right corner to select a different area to zoom. You can also click and drag to draw a zoom in area.



- 10 **Reverse Playback:** Playback the video in reverse.
- 11 **Stop:** Stop playback.
- 12 **Pause playback:** Click again to resume playback.
- 13 **30s Rewind:** Rewind video by 30 seconds.
- 14 **30s Fast Forward:** Fast forward video by 30 seconds.
- 15 **Rewind:** Slow down video playback (x1/2, x1/4, x1/8, Single Frame).
- 16 **Fast Forward:** Speed up video playback (x2, x4, x8, xMAX).
- 17 **Play Previous Recording:** For Normal playback, start playing the previous day's recordings. For Event playback, start playing the previous motion detection recording. For Tag playback, start playing the previous tagged event.
- 18 **Play Next Recording:** For Normal playback, start playing the next day's recordings. For Event playback, start playing the next motion detection recording. For Tag playback, start playing the next tagged event.
- 19 **Continuous:** Represents normal event recording (manual and schedule) segments on the video timeline.
- 20 **Motion:** Represents motion detection event recording segments on the video timeline.
- 21 **Timeline Zoom:** Zoom in (to show shorter, detailed time period) or out of the video timeline.

8.2 Search/Export

When a video is recorded, it is stored as a file on your DVR's hard drive. In this menu, you can copy video recordings from your DVR's hard drive to an external storage device such as a USB flash drive.

NOTE: Before exporting a video file, the external USB flash drive or memory stick **MUST** be in FAT32 or NTFS file format.

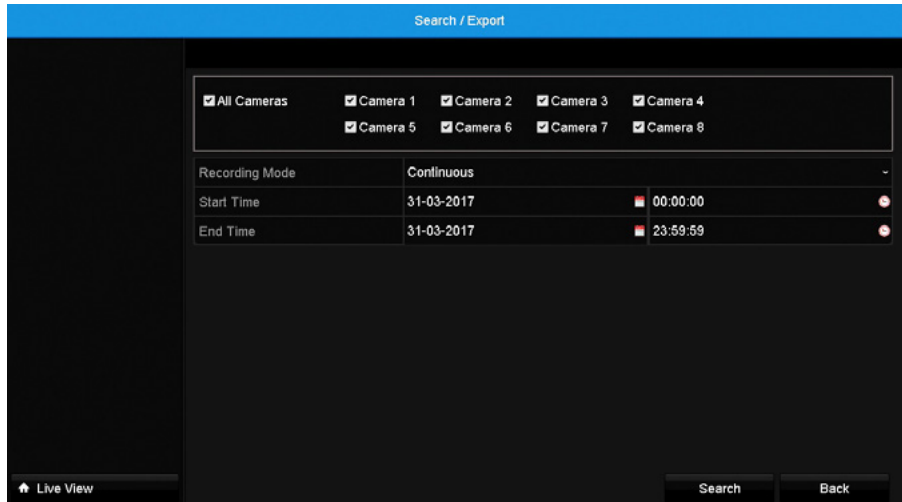

Steps to export recordings:

- 1 Connect a USB storage device to the USB port on the back of the DVR.
- 2 Specify the channel(s), record type, file type and time period to search for recordings.
- 3 Click Search. The DVR shows you all of your recordings matching your search criteria, when they were recorded and what channel they were recorded.

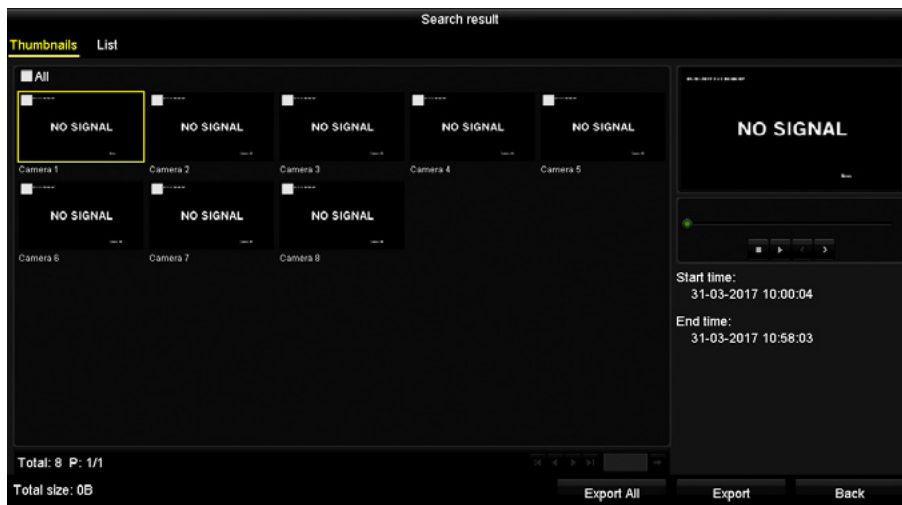

- 4 Select the recordings you want to copy, and then click Export, or to select all recordings, click Export All.

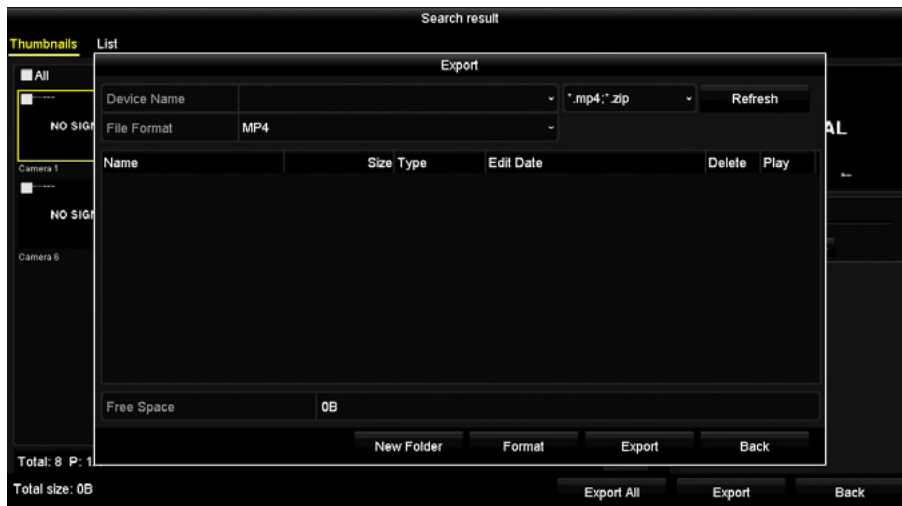

- 5 In the Device Name list, make sure your USB device is the current selection. You can also create a new folder in your USB device to store your DVR recordings by clicking New Folder.
- 6 Click Export.
- 7 Select Video and Log, then click OK to begin copying the selected recordings to your USB storage device. Wait until the “Export finished” message is displayed before removing your USB storage device.

NOTE: If you require a media player to watch video files on your computer, repeat step 6, select Player and then click OK to copy a media player application to your USB device.

8.3 Camera Management

In this menu, you can adjust or modify individual camera settings connected to your DVR.

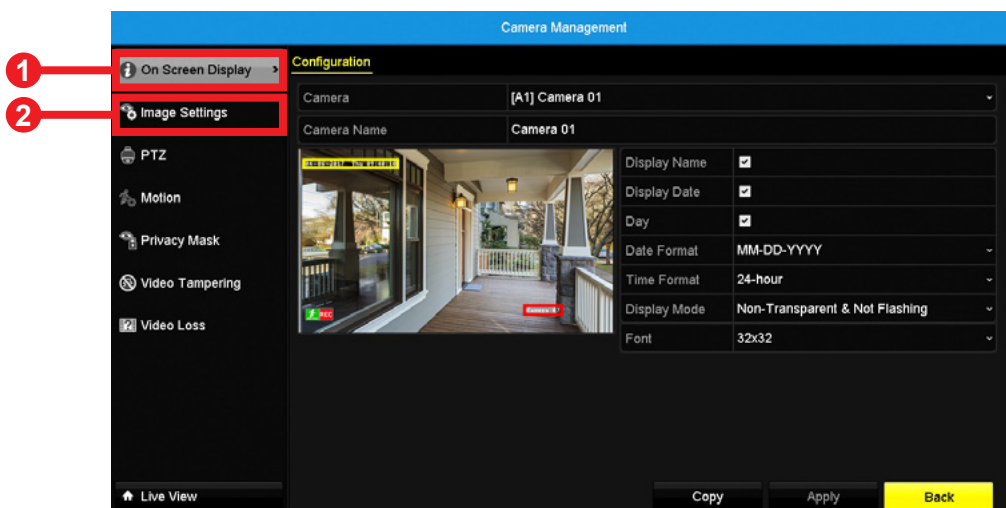

- 1 **On Screen Display:** Configure the on-screen display for the display name, display date, date format, time format and font size.
- 2 **Image Settings:** Make adjustments to how the DVR displays the image coming from your cameras.

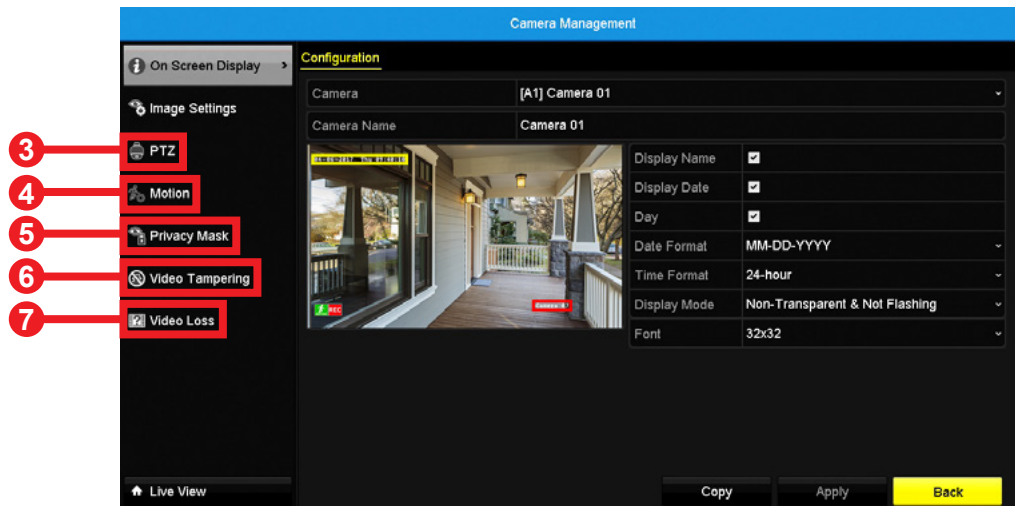

- 3 **PTZ:** Configure settings on your DVR to control a PTZ-enabled camera.
- 4 **Motion:** Configure the motion detection settings and sensitivity level for each camera. By default, the DVR has motion recording enabled on every channel, configured to operate at an average level of sensitivity.
- 5 **Privacy Mask:** Create and place “privacy masks” to conceal parts of the camera’s image on the screen. This restricts what can be seen in Live View and on the video recording–useful when you want to protect personal privacy or sensitive areas.
- 6 **Video Tampering:** Can be used in scenarios where someone may cover up the camera’s field of view or if they are attempting to tamper with the video signal.
- 7 **Video Loss:** Regarded as a potential alarm event, and is considered to occur any time that the DVR doesn’t receive an active video signal on any of its inputs.

8.3.1 On Screen Display

This menu allows you to make changes to the on screen display information related to each connected camera.

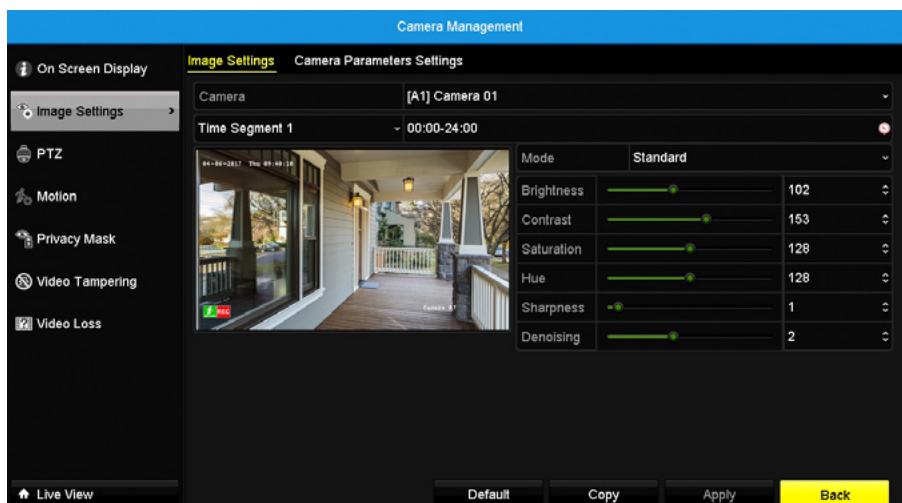

Camera Name: You can specify a name of up to 32 characters for the selected camera. By default, all channels are named as the Camera No. field, but this can be set to anything you like.

Display Name: Select whether the name of the camera appears on the screen.

Display Date: Select whether the current date appears on the screen.

We strongly recommend leaving this box checked, and ensuring that the date is correct.

Date Format: Select how you want the date to be displayed. The default format is MM-DD-YYYY.

Time Format: Select how you want the time to be displayed. The default format is 24-hour.

Display Mode: Select how the OSD (On Screen Display) appears. Bear in mind that some OSD settings (such as Transparent and/or Flashing) are harder for a video forger to impersonate or modify than other settings—on the other hand, they're harder to read. Select the best setting for your circumstances—it's worth having a look at a few settings to see what options are available.

Font: Select the information text size that appears on the screen.

8.3.2 Image Settings

In this menu, you can adjust image settings related to each connected camera.

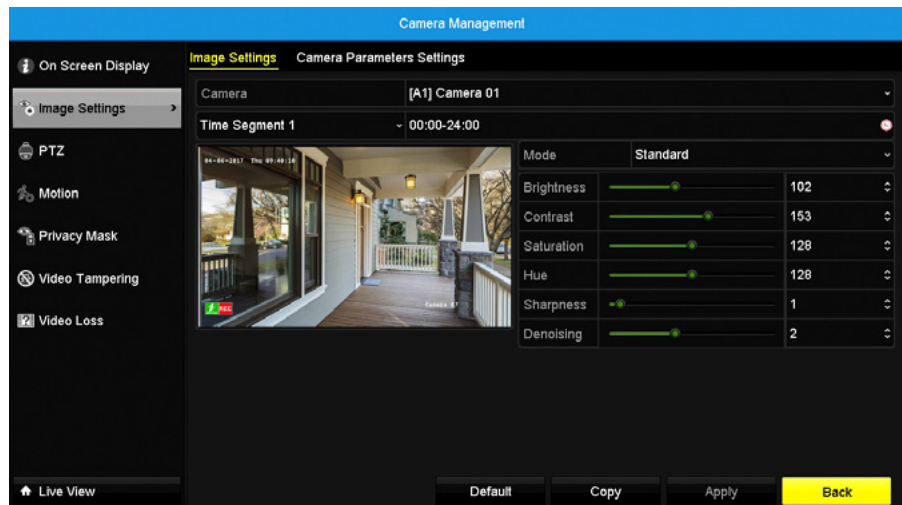

Camera: Select the camera you want to configure.

Time Segment: This determines the time period for which you would like to apply the settings. The default setting is for 24hrs. This is particularly useful if you would like to have different image settings for different times of the day.

Mode: There are four preset modes that you can select from: Standard, Indoor, Dim Light and Outdoor.

Brightness: Change how light the image appears on screen. This setting cannot make the camera see further in the dark or increase the clarity of an image in low-light environment.

Contrast: Increase the difference between the blackest black and the whitest white in the image. Useful if sections of the image “grey out” but setting the contrast too high will degrade image quality.

Saturation: Alter how much color is displayed in the image. The higher the saturation, the more bright and vivid colors will appear to be.

Hue: Change the color mix of the image.

Sharpness: How crisp your images will be. Setting the sharpness too high will make your pictures look pixelated. Setting the sharpness too low will make everything look soft and blurry.

Denosing: Select the level of noise reduction to be applied to the video signal.

NOTE: If the camera’s image settings are changed and the result is not ideal, you can always reset image settings to the default values by clicking “Default”. You can easily copy the current camera’s image settings to other cameras. Simply click Copy, select which cameras and then click OK.

8.3.3 Camera Parameter Settings

In this section of the menu, you can change the sensitivity of the cameras reacting to light. This will extend or shorten the Night Vision settings of your cameras.

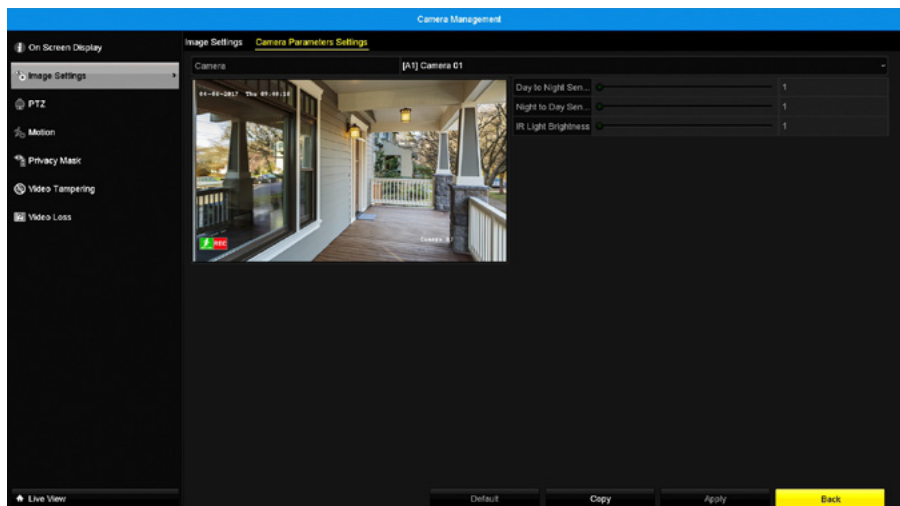

Camera: Select the camera you want to configure.

Day to Night Sensitivity: Change the camera sensitivity to switch from Day Vision (Color Image) to Night Vision (B/W Image). If the sensitivity is set to high, the camera will require less light change to switch to Night Vision, thereby extending Night Vision.

Night to Day Sensitivity: Change the camera sensitivity to switch from Night Vision (B/W Image) to Day Vision (Color Image). If the sensitivity is set to high, the camera will require more light to switch to Day Vision, thereby extending Night Vision.

IR Light Brightness: IR Light is used for Night Vision Mode, determine the brightness of the IR Light with this setting.

8.3.4 PTZ

The PTZ menu applies to any connected PTZ-enabled camera.

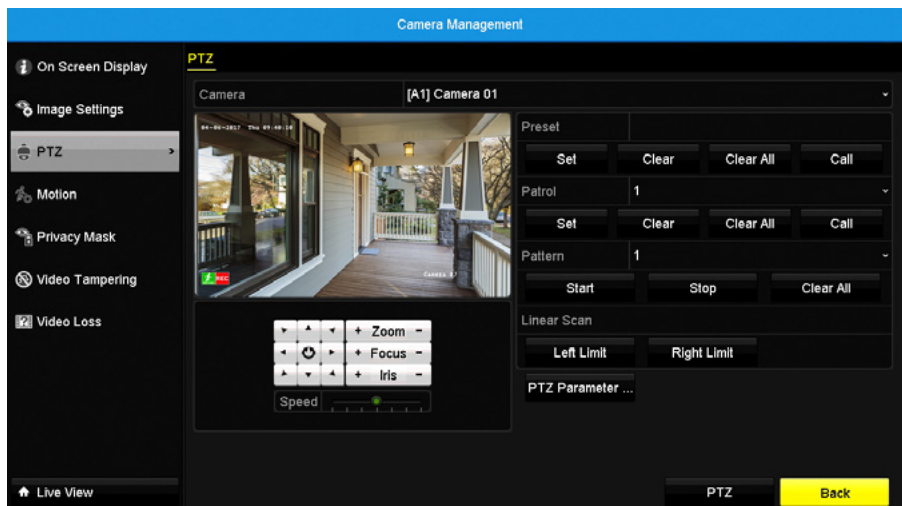

Camera: Select the camera you want to configure.

PTZ Controls: Use the PTZ controls to move the camera to the desired focal position. The zoom and focus controls can also be used. You can use the speed control to determine how fast or slow the camera will move.

Preset: A preset is a position within the image that you would like the camera to focus on.

Patrol: Patrol mode instructs your DVR to automatically move the camera according to the preset positions that have been created. You can increase or decrease the duration before moving to the next preset position.

Pattern: No function on this model.

Linear Scan: No function on this model.

PTZ Parameter Settings: Settings for a PTZ camera must be configured before it can be used.

PTZ Full Controls: Click PTZ to access the full PTZ controls available for the specific camera.

8.3.5 Motion

In this menu, you can adjust or modify individual camera settings connected to your DVR.

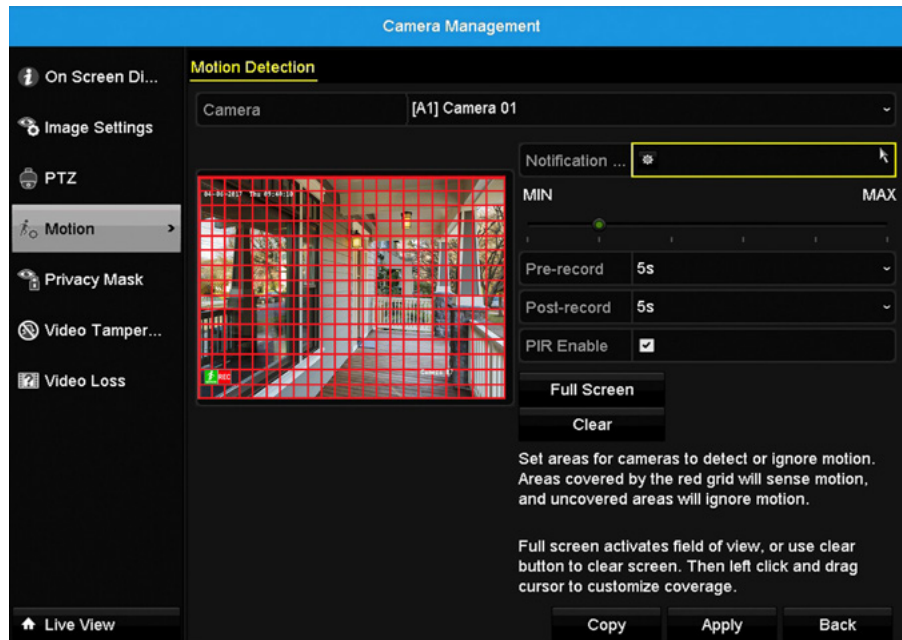

Camera: Select the channel you want to configure.

Notifications Settings: Specify how your DVR should respond and notify you when it detects motion. You can trigger additional cameras to start recording, you can adjust your arming schedule, send email alerts or trigger the DVR's internal alarm to sound.

Sensitivity: Move the slider to set a value between MIN and MAX. The closer to MAX the slider is set, the more sensitive the motion detection will be.

Pre-record: The number of seconds the DVR will record before the scheduled time or event occurs. For example, setting this to 30 seconds will enable recording for a motion event that occurred at 12:00:00 to contain footage from 11:59:30.

Post-record: The number of seconds the DVR will continue recording after the scheduled time or event occurs. For example, setting this to 30 seconds will enable recording for a motion event that occurred at 12:00:00 to stop recording at 12:00:30.

PIR Enable: Enable or Disable the PIR sensor on the selected camera(s).

Full Screen: Select the entire view area of the camera preview window for motion detection.

Clear: Clear the entire view area of the camera preview window.

8.3.6 Privacy Mask

In this section of the menu, you can create and place “privacy masks” to conceal parts of the camera’s image on the screen. This restricts what can be seen in Live View and on the video recording—useful when you want to protect personal privacy or sensitive areas.

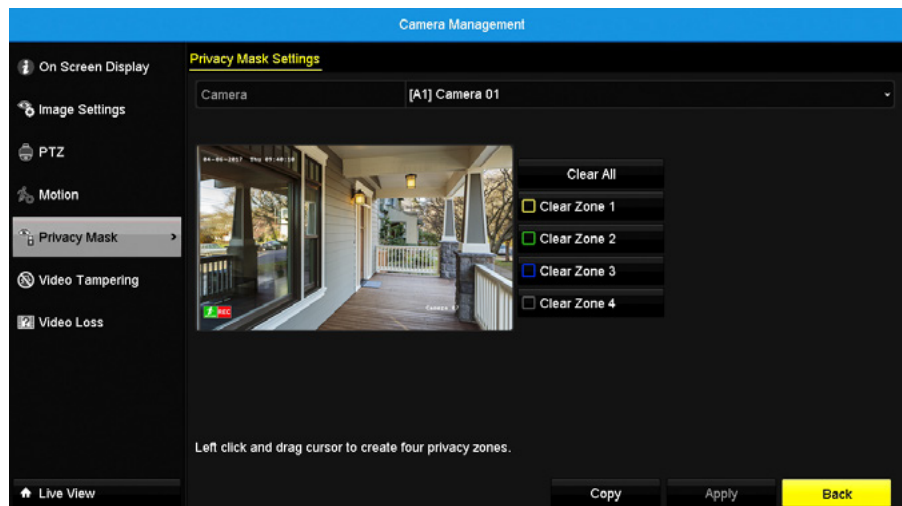

You can place up to four zones per camera to hide from view. Click and drag on the preview window to select the area you want to hide. To remove an existing privacy mask, click on the Clear Zone button associated with the outline color of the privacy mask.

8.3.7 Video Tampering

Video Tampering can be used in scenarios where someone may cover up the camera’s field of view or if they are attempting to tamper with the video signal.

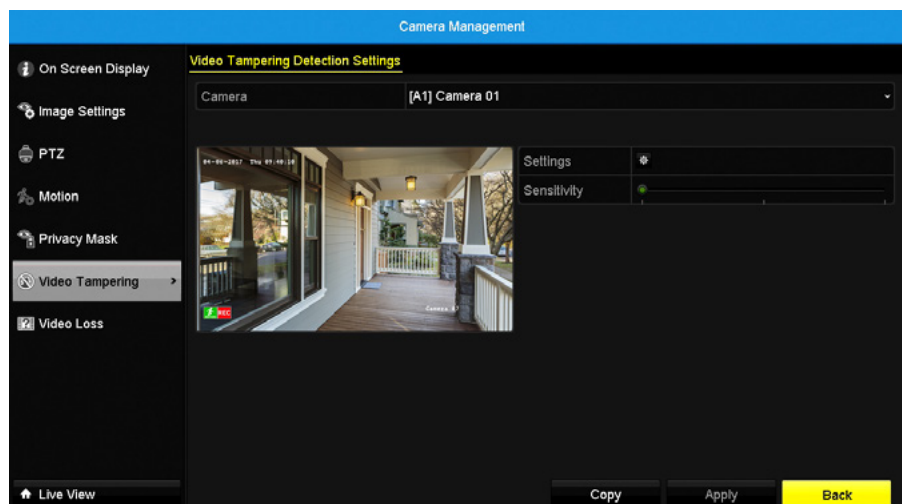

Camera: Select the channel you want to configure.

Settings: Specify the DVR's actions when it detects tampering on the selected camera.

Options available are:

- **Full Screen Monitoring:** The affected camera's screen is displayed in full screen mode.
- **Audible Warning:** A continuous audible beeping is heard from the DVR.
- **Push Notification:** A warning message is sent to the Night Owl X or Night Owl X HD client software.
- **Send Email:** If you have configured your email account details, an alert is sent to your email address.

Sensitivity: Move the slider to increase or decrease the level of sensitivity.

8.3.8 Video Loss

Video loss is regarded as a potential alarm event, and is considered to occur any time that the DVR doesn't receive an active video signal on any of its inputs.

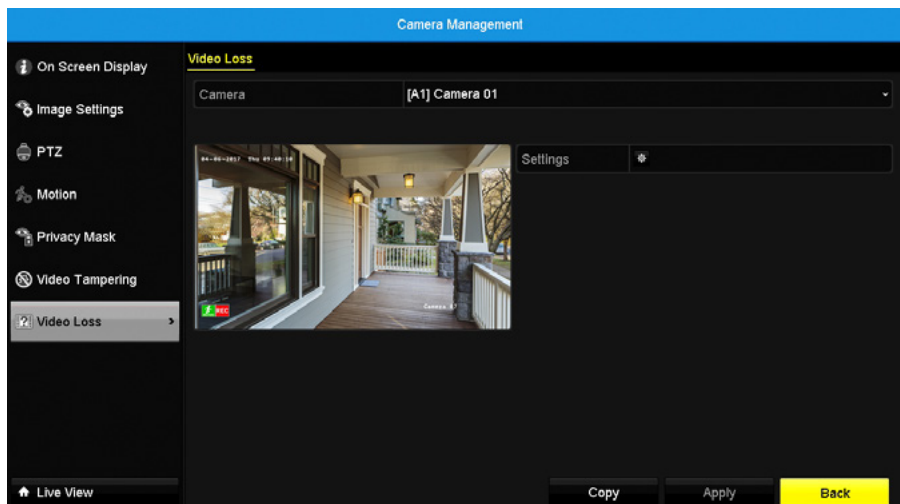

Camera: Select the channel you want to configure.

Settings: Specify the DVR's actions when it detects video loss on the selected camera.

Options available are:

- **Full Screen Monitoring:** The affected camera's screen is displayed in full screen mode.
- **Audible Warning:** A continuous audible beeping is heard from the DVR.
- **Push Notification:** A warning message is sent to the Night Owl X or Night Owl X HD client software.
- **Send Email:** If you have configured your email account details, an alert is sent to your email address.

8.4 Record

This menu allows you to edit DVR record scheduling, video quality settings and set overwrite preferences.

8.4.1 Schedule

Within this menu, you can specify when the DVR records video and under what mode for each channel. By default, all channels are armed to use Motion Detection as their recording mode.

The schedule presented on-screen applies to one camera over one entire week. There is a 24-hour timeline for each day of the week. Each square in the timeline represents an hour in the 24-hour period.

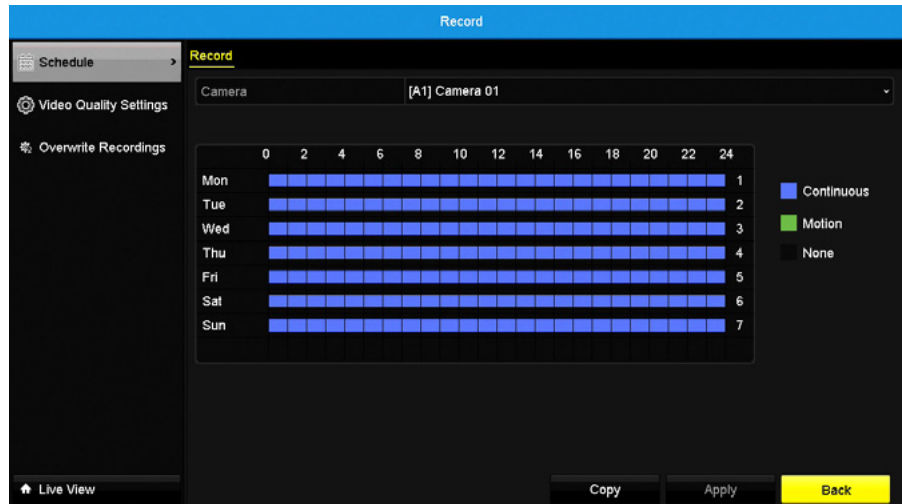

When defining a recording schedule, there are 3 types of recording to choose from:

- **Continuous (Blue):** The DVR will constantly record for any period. You won't miss anything, but constant recording will fill your hard drive very quickly. Typically, we suggest Motion as a better recording mode for most users.
- **Motion (Green):** The default and recommended recording setting. The DVR will only record when it detects something moving in front of a camera, and will then only record footage from the camera(s) that do detect motion.
- **None (Black):** The DVR will not record anything.

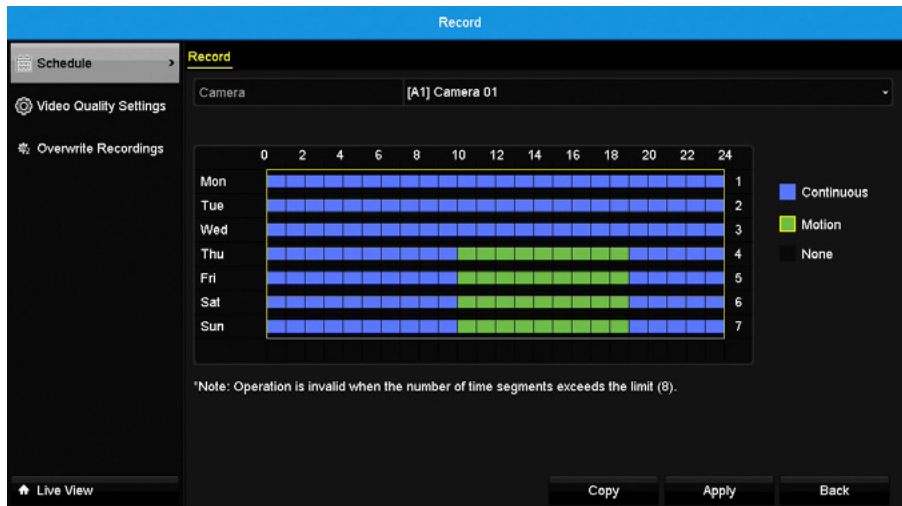

How to change the camera's recording schedule:

- 1 In the Camera list, select a channel.
- 2 To set a recording mode for a specific time and day, first select the mode and then click the corresponding square(s) in the timeline. The color of the square changes to the assigned recording mode. To quickly cover a large portion of time squares, you can simply click and drag the mouse over the squares corresponding to your desired days and times.

NOTE: Use the Copy button to quickly assign identical schedule layouts to multiple channels at once.

8.4.2 Video Quality Settings

In this section of the menu, you can customize how the DVR records footage and “encodes” the files. “Encoding” is a term which refers to the compression algorithm used by the DVR.

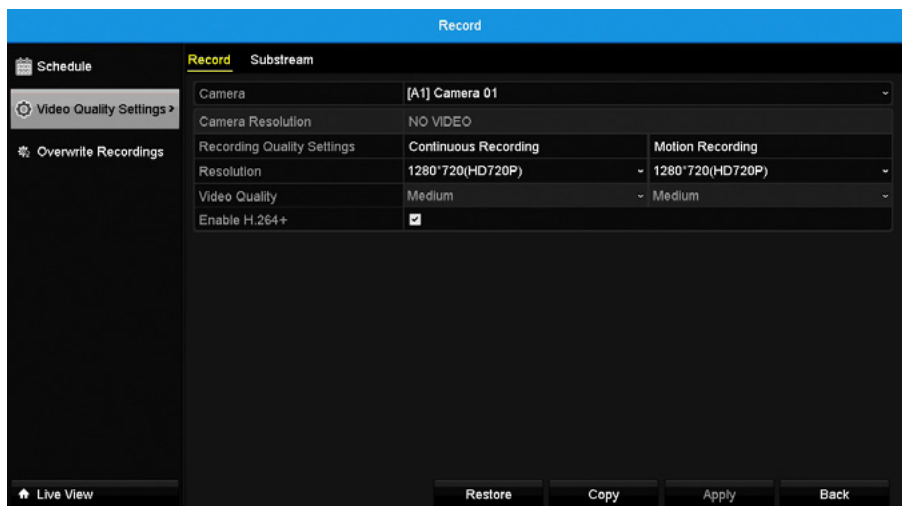

Camera: Select the camera you want to configure.

Camera Resolution: The video resolution and frame rate of the selected camera.

Recording Quality Settings: You can change Main Stream settings for both Continuous and Event recordings, and it is recommended to select the same settings for both recording types.

Resolution: The number of frames per second (fps) that the DVR will record.

Video Quality: The actual amount of data that the DVR uses to record video. Options are low, medium and high quality. The higher the bitrate, the more space each recording takes up on the hard disk. Recordings encoded at higher bitrates will be of better quality, especially when recording movement.

H264+: By enabling this check mark, the DVR will compress the video at the maximum compression rate that H264 can reach, while retaining optimal video quality. It is enabled by default and doubles the recording space capacity on your DVR's HDD.

NOTE: You can easily copy the current Main Stream recording settings to other cameras. Simply click Copy, select which cameras and then click OK.

The Substream Menu within the Video Quality Settings tab will allow you to customize encode settings for Smart Devices utilizing the Night Owl X application.

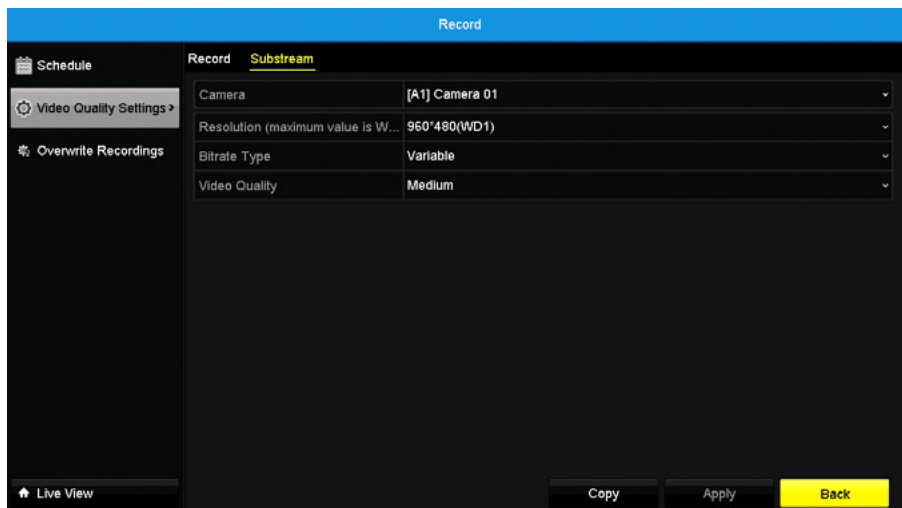

Camera: Select the camera you want to configure.

Resolution: A fraction of the Main Stream and what you will see over the Internet or via a smart device. Typically, the Substream resolution will be of significantly lower quality and bitrate than the Main Stream.

Bitrate Type: Type of H264 compression, “Variable” is recommended and it is the default setting.

Video Quality: Amount of data that the DVR uses to record video. Options are low, medium and high quality. The higher the bitrate, the more space each recording takes up on the hard disk. Recordings encoded at higher bitrates will be of better quality, especially when recording movement.

NOTE: You can easily copy the current Substream recording settings to other cameras. Simply click Copy, select which cameras, and then click OK.

8.4.3 Overwrite Recordings

The Overwrite option is enabled by default. This allows the DVR to be able to record events as they happen. If the hard drive is full, the DVR will record over recordings already stored on the hard drive. The DVR will always record over the oldest files on your hard drive first.

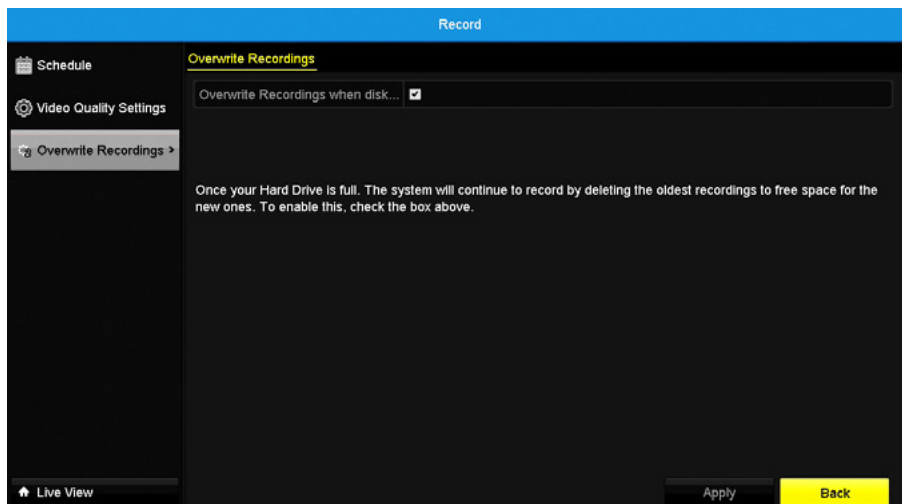

8.5 Hard Drive

This menu allows you to format the hard drive(s) in the DVR. Do not format a drive that already has data on it, as the initialization process will erase any information on the drive.

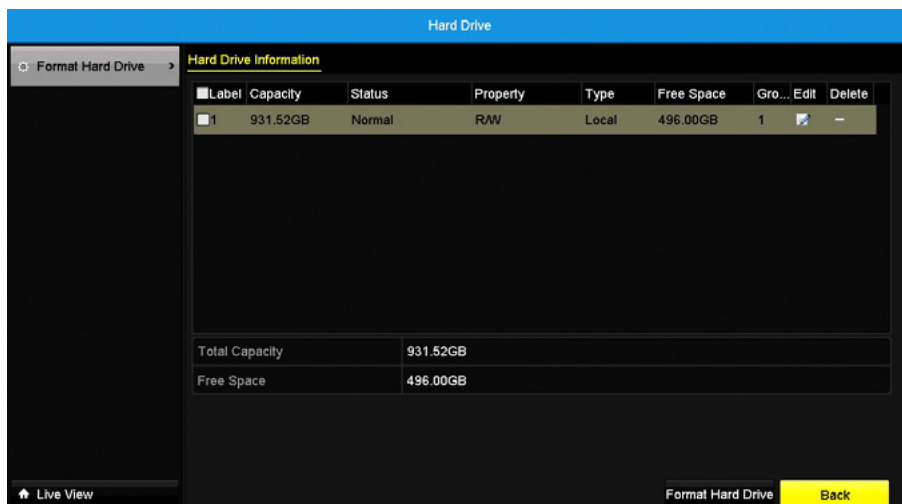

Format Hard Drive: Click this button to format the selected drive. Keep in mind, formatting the HDD will erase all video files from the HDD.

8.6 Configuration

Within this menu, you can configure general, network, live view, system events and user settings for your DVR system.

8.6.1 General

The General tab of the Configuration menu will allow you to access display and system settings for your DVR.

8.6.1 (a) General

In this section of the menu, you can configure general DVR settings such as language, time and date, mouse pointer speed, and more.

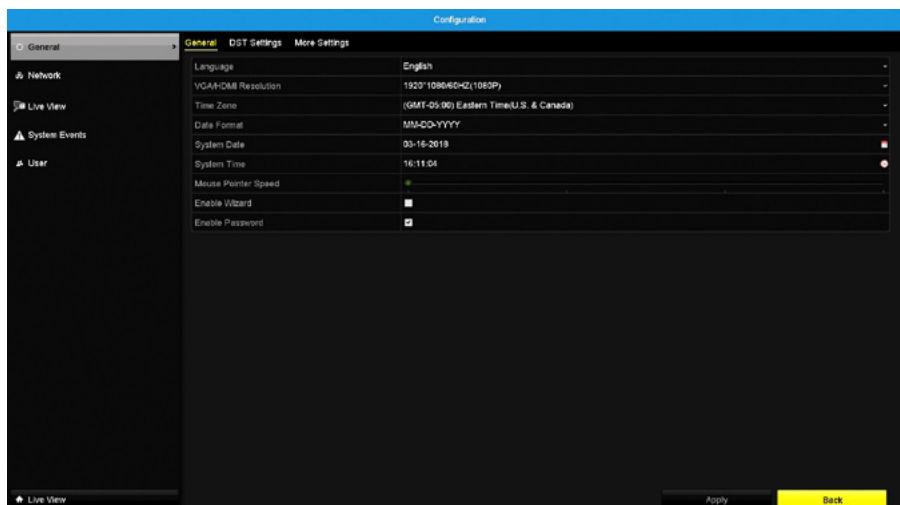

Language: The language to display the DVR's menus, alerts and other communications. Available language options are English, French and Spanish.

Resolution: DVR Output Resolution.

Time Zone: Time Zone is particularly important if you have enabled NTP—set this to your time zone.

Date Format: On screen display of the Date.

System Date: This can be edited manually, or set to update automatically by using NTP.

System Time: This can be edited manually, or set to update automatically by using NTP.

Mouse Pointer Speed: Move the slider to increase or decrease the mouse pointer speed.

Enable Wizard: When checked, the DVR will automatically run the setup wizard when the DVR is switched on.

Enable Password: When enabled, the DVR will require a password for any operation to be performed. Night Owl recommends enabling password protection.

8.6.1 (b) DST (Daylight Savings Time)

In this section of the menu, you can configure settings related to daylight savings time.

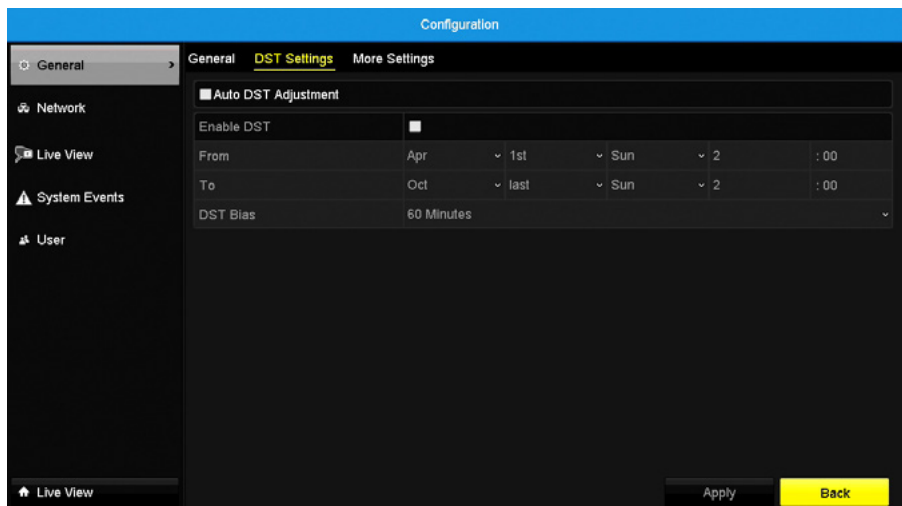

Auto DST Adjustment: DST will adjust automatically.

Enable DST: Enable this setting if you want the DVR to adjust the time when daylight savings time begins.

From/To: Define when daylight savings applies to your location.

DST Bias: This refers to the difference in minutes, which is typically 60 minutes in many locations.

8.6.1 (c) More Settings

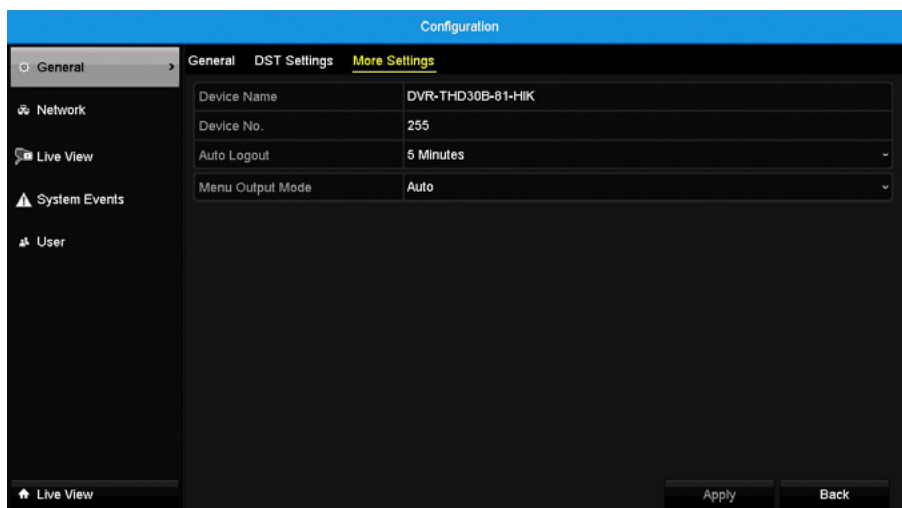

Device Name: The default name of the DVR. You can also enter your own name for the DVR.

Device Number: The internal device number of the DVR.

Auto Logout: Select how long a menu screen remains inactive before the DVR closes the menu screen and displays Live View screen.

Menu Output Mode: If you have multiple displays connected to your DVR, you can select which display the Menu Bar and Menu will be displayed on (either HDMI or VGA), otherwise leave the default setting.



In this menu, you can configure network settings for your DVR, obtain information regarding remote access and email notifications.

8.6.2 (a) General

In this section of the menu, you can manually configure network settings for your DVR. It is usually not required as the DVR automatically configures them for you when you connect the DVR to your router via the Ethernet cable.

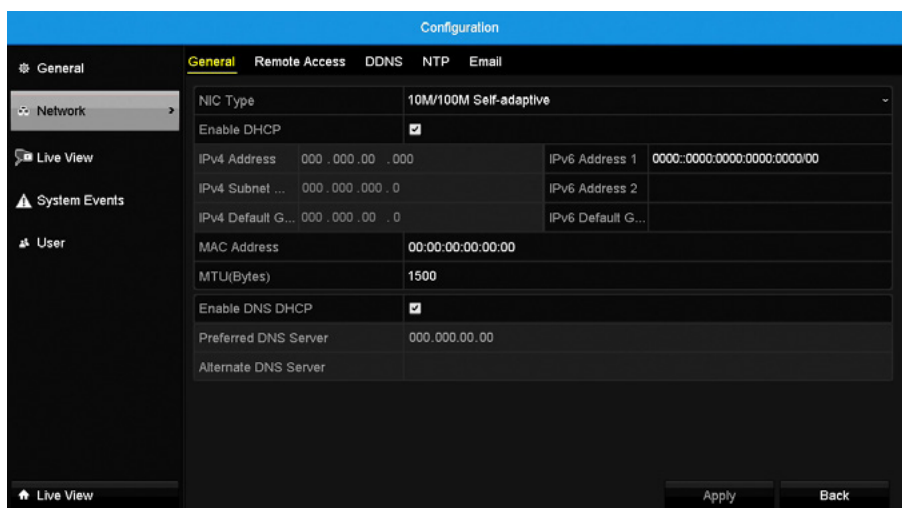

NIC Type: Your DVR has the ability to connect to your LAN (Local Area Network) at various speeds and can adjust itself accordingly depending on the network traffic. It is recommended to leave the current default setting for the best streaming performance.

Enable DHCP: DHCP (Dynamic Host Configuration Protocol) is a system where one device on your network (usually a router) will automatically assign IP addresses to devices connected to the network. This option is enabled by default and is the recommended way for the DVR to receive an IP address from your router. If you require the DVR to have a static IP address, you will need to disable this option. Static networks require all devices to have their IP addresses manually defined, as there is no device dedicated to automatically assigning addresses.

IPv4 Address: Network address of the connected DVR.

IPv4 Subnet Mask: The range of IP addresses that are found in the network. This **MUST** be set to the default address 255.255.255.000.

IPv4 Default Gateway: The connection between two networks. This should always be the IP address of the connected router.

MAC Address: The unique identifier assigned to network interfaces for communications at the data link layer.

MTU (Bytes): The MTU (Maximum Transmission Unit) is the size of the largest datagram that can be sent over a network. It is recommended to leave the default setting.

Preferred DNS Server: “Domain Name System server address.” Everything on the Internet is located via an IP address - however, for ease of use, we associate domain names.

Alternate DNS Server: Backup DNS server.

8.6.2 (b) Remote Access

This section of the menu will show you how to pair the Night Owl X app with your DVR.

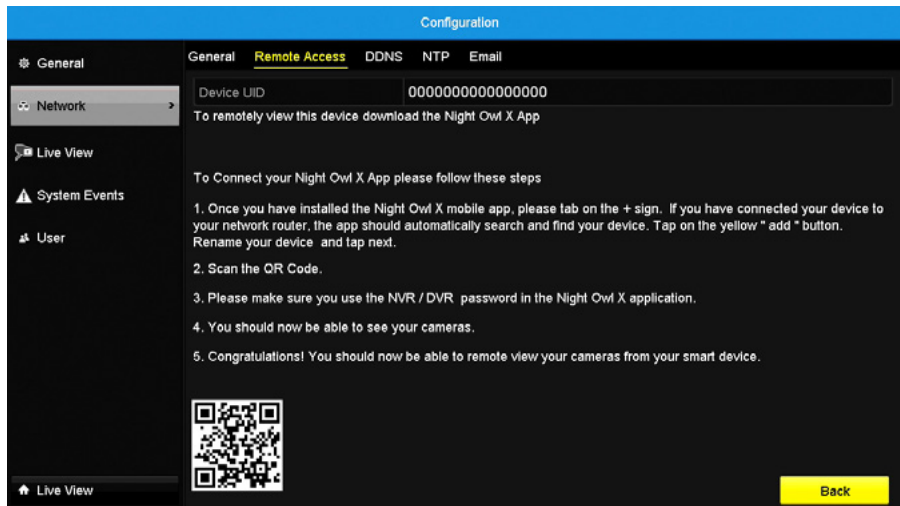

8.6.2 (c) DDNS

Enable or Disable DDNS service to view your DVR from a computer.

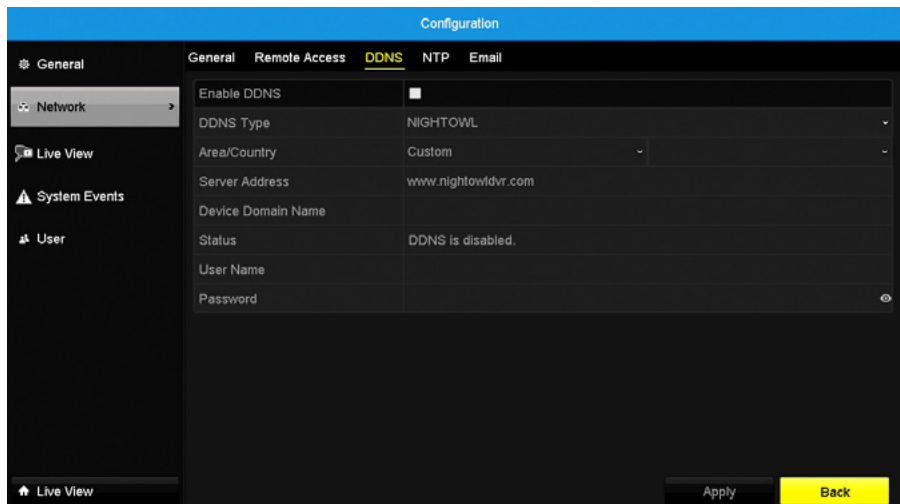

Device Domain Name: Set to the domain name you created when registering your DDNS.

User: The username created during the DDNS registration process.

Password: The password created during the DDNS registration process.

8.6.2 (d) NTP

You can configure the NTP server details to obtain current date and time.



Enable NTP: Enable the DVR to connect to an NTP server.

Interval (min): The amount of time in minutes that will elapse between the DVR updating its internal clock to match that of the NTP server. The default period of 60 minutes is recommended.

NTP Server: The default server used to obtain accurate date and time.

NTP Port: The default is 123, you should only change this if you're using a different NTP server and you know that it uses a different port. If you're using pool.ntp.org, ensure the port is 123.

8.6.2 (e) Email

In this section of the menu, you can configure Email settings to allow alarm notifications to be sent from your DVR.

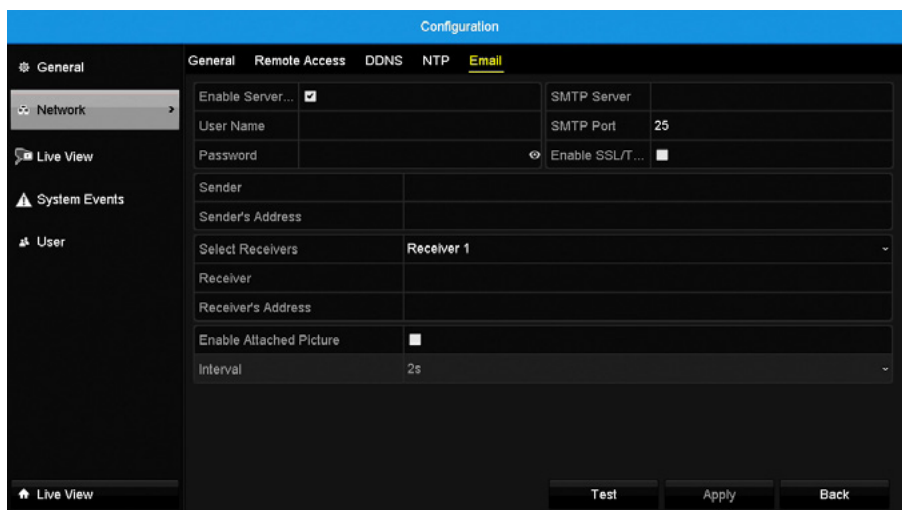

Enable Server Authentication: If your outgoing mail server requires authentication, ensure this box is checked.

Username: The username for the outgoing email account.

Password: The password for the outgoing email account.

SMTP Server: The SMTP server address of your email provider. For commonly used mail server settings, see “Common Email Provider Settings” below. If your email provider is not listed in the table, use your Internet browser to easily find your email provider’s server address and port by searching ‘smtp settings’ followed by the name of your email provider.

SMTP Port: The SMTP port used by your email provider.

Enable SSL: Whether the email server you are using requires a secure link.

Sender: Enter a name to identify the sender of the email notification.

Sender Address: The address from which you are sending the email. This will be the username you have set up for the email server you are using, followed by “@” and then the email server. For example: “username@gmail.com” or similar.

Select Receiver: Select an e-mail recipient to configure. The DVR can send email notifications to up to three receivers.

Receivers Address: The email address of which you would like the DVR to send emails. This can be any email address you like, however, bear in mind that the DVR might send a large number of automatic emails under certain conditions.

Enable Attach Picture: When this is selected, the DVR will attach a small image to each email alert (where applicable). For motion-based email alerts, this will be an image of whatever triggered the motion detection.

Interval: The length of time that must elapse after the DVR sends an email alert before it can send another.

Common Email Provider Settings:

- **Gmail Server Address:** smtp.gmail.com
Port: 465 or 587
Requires SSL: Yes
- **Hotmail/Live.com Server Address:** smtp.live.com
Port: 465
Requires SSL: Yes
- **AOL Server Address:** mail.aol.com
Port: 465
Requires SSL: Yes
- **Yahoo Server Address:** smtp.mail.yahoo.com
Port: 465 or 587
Requires SSL: Yes

- **iCloud Server Address:** smtp.mail.me.com
Port: 587
Requires SSL: Yes
- **Outlook.com Server Address:** smtp.live.com
Port: 587
Requires SSL: Yes

8.6.3 Live View

These options allow you to configure Live View display settings.

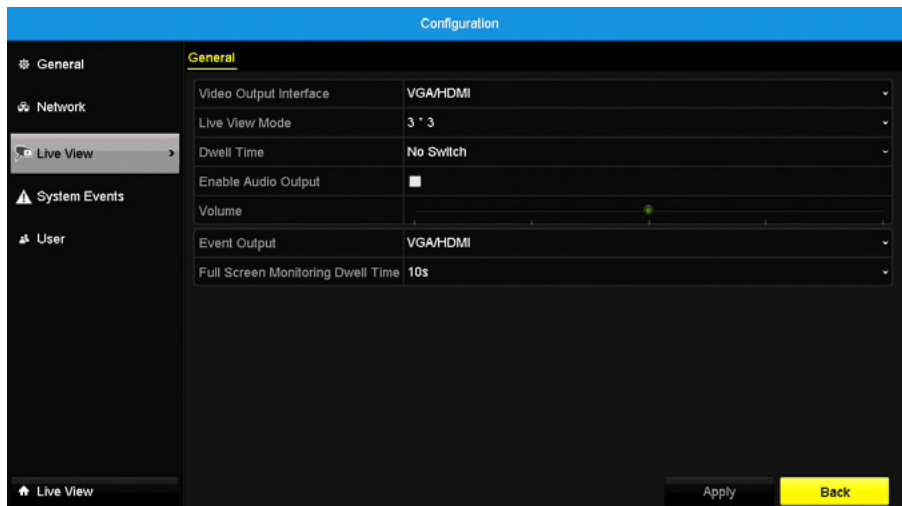

Video Output Interface: The default output is VGA/HDMI.

Live View Mode: Select which Multiview format to be the default in Live View mode.

Dwell Time: Set the number of seconds to dwell on a video channel before switching to the next channel when enabling Start Auto-switch via the Mouse Menu in Live View.

Enable Audio Output: As the cameras supplied with the DVR do not support audio capture, this option is not required.

Volume: DVR audio output volume.

Event Output: The default output is VGA/HDMI.

Full Screen Monitoring Dwell Time: The amount of time that the alarm event window will be displayed.

8.6.4 System Events

In this section of the menu, you can enable the DVR to monitor for alarm events or exceptions. An exception is any deviation from the DVR's normal behavior—phrased another way, it's like saying the DVR's been working fine except for these events.

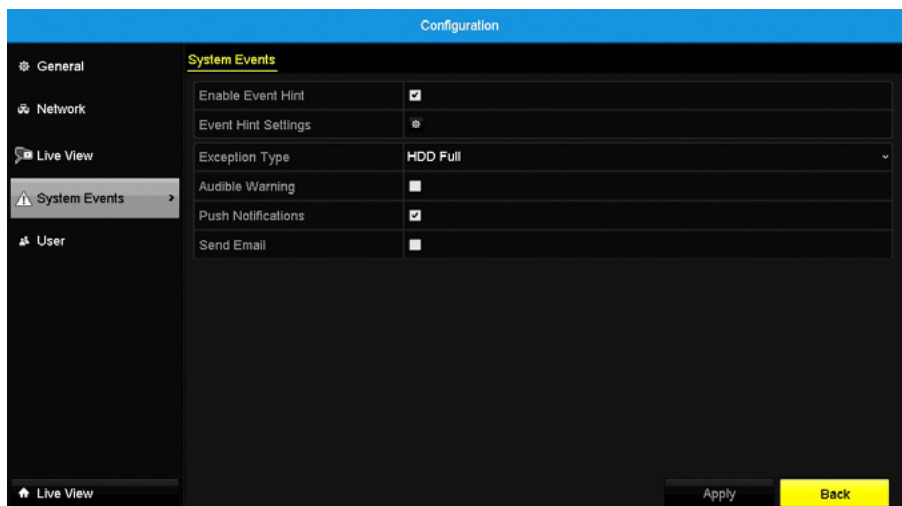

Enable Event Hint: Enable the DVR to monitor for alarm events and system exceptions. When an exception occurs, the DVR displays the icon on the Live View screen.

Event Hint Settings: Select the type of alarm events and exceptions that will trigger the display of the icon.

Exception Type: Select the exceptions you want the DVR to react to. By configuring the action for these events, you can create any combination of audio alerts or auto-emails to be sent for different event types. The types of exception available are:

- **HDD Full:** Occurs when the DVR runs out of space on the hard drive to save new footage. This event is redundant if you have Overwrite setting enabled, as the DVR will automatically delete old footage to ensure it can continue to record.
- **HDD Error:** Occurs when the DVR has trouble accessing its hard drives, or when it cannot detect one at all.
- **Network Disconnected:** Occurs when the DVR has problems connecting to the Internet. This may indicate a problem with the DVR's configuration, a fault with your network or a problem with your Internet Service Provider (ISP).
- **IP Conflicted:** Occurs when the DVR detects another device on the same network with a conflicting IP address. Basically, it indicates that two devices are trying to use the same IP address. This should not occur if you're using DHCP addressing, unless one or more devices is set to use a STATIC IP (the static addressing method overrides the automatic assignment process).
- **Illegal Login:** This will occur if the DVR detects a login with an incorrect username or password.
- **Input/Recording Resolution Mismatch:** If the camera connected is not capable of matching the resolution selected in the "Record Tab" menu.
- **Record Exception:** This will occur if there are unexpected errors during capture such as a HDD failure, the HDD is full or the HDD quota has been changed.

Audible Warning: A continuous audible beeping is heard from the DVR when an exception occurs.

Push Notification: A warning message is sent to the Night Owl X client software when an exception occurs.

Send Email: If you've have configured your email account details, an alert is sent to your email address when an exception occurs.

8.6.5 User

Within this section of the menu, you can change the Admin account's password and configure Guest and Operator accounts to have restricted access to the DVR.

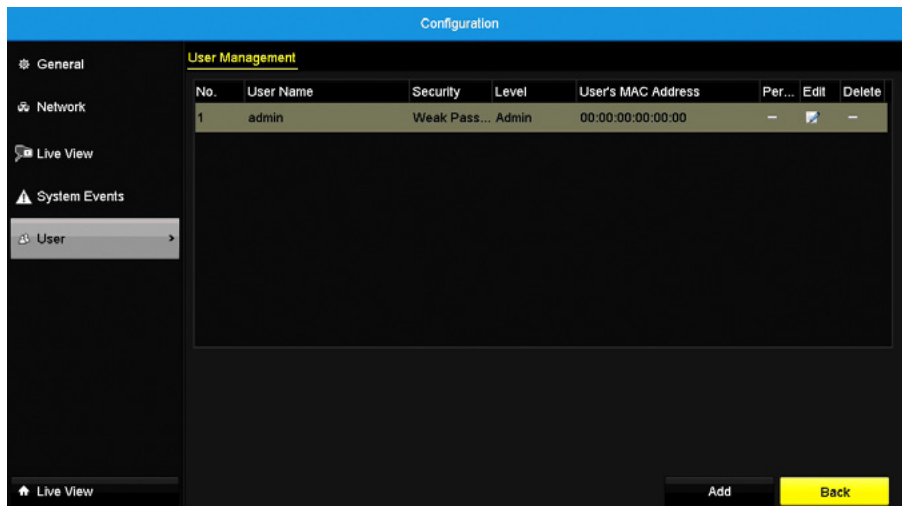

To add additional users, select Add:

- 1 An Operator user account can access all camera operations including playback and exporting of video recordings with limited access to many menus. Any operation that requires changing the DVR or camera setting cannot be performed.
- 2 A Guest user account can only watch live view from the camera and playback camera recordings.

To remove a user, select a Username from the table, and then click the Delete icon button.

8.7 Maintenance

In the Maintenance menu, you can access information related to your DVR system, connected cameras, network and alarm settings.

8.7.1 System Info

The System Info tab of the menu contains your DVR's system information, camera status, recording and network configuration and the status of your hard drive.

8.7.1 (a) Device Info

Within this menu, you can view your DVR's (default) name, model, serial number, firmware version, hardware version and request for a firmware upgrade.

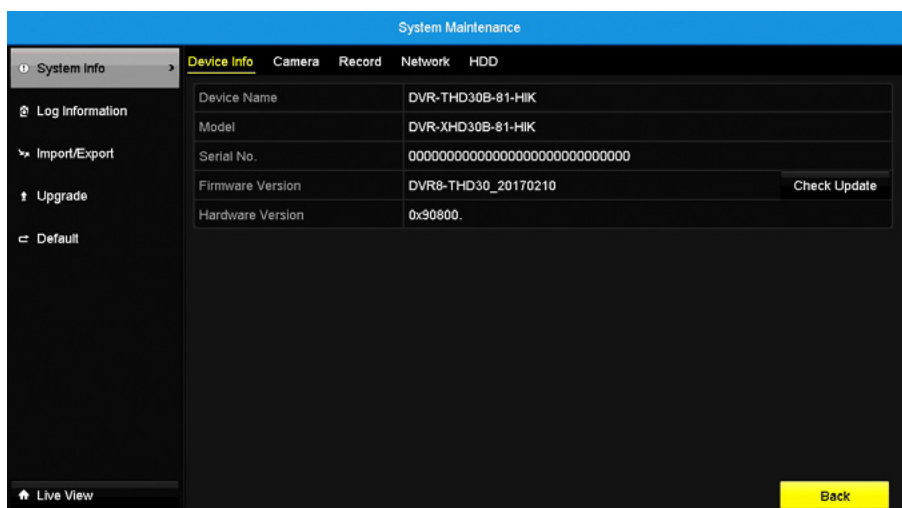

To upgrade your firmware online, click the Check Update Button. If a new firmware is available, the system will suggest upgrading to the most current firmware version.

8.7.1 (b) Camera

In this section of the menu, you can check on the status of each camera connected to the DVR. You can easily find out which DVR features such as motion detection, video tampering, etc. are being utilized by the cameras.

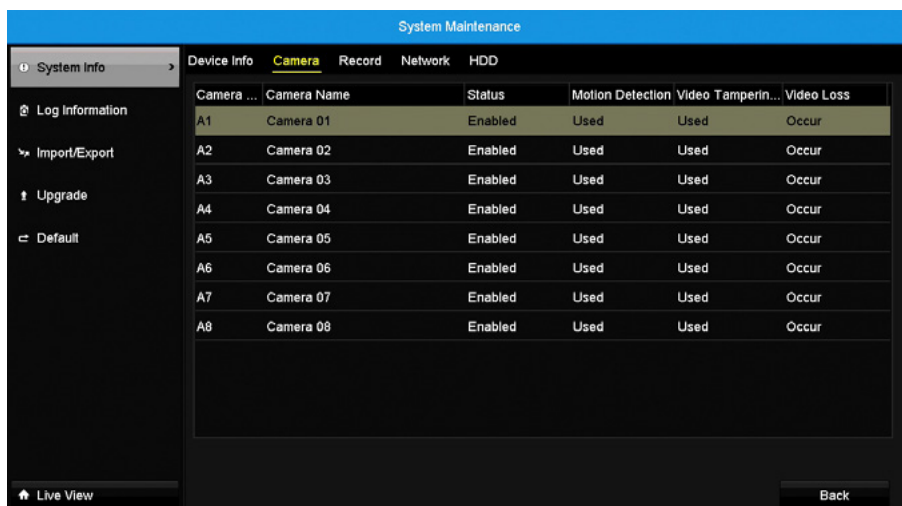

8.7.1 (c) Record

In this section of the menu, you can check on the recording settings for each camera connected to the DVR. You can also find out if any camera has a recording in progress.

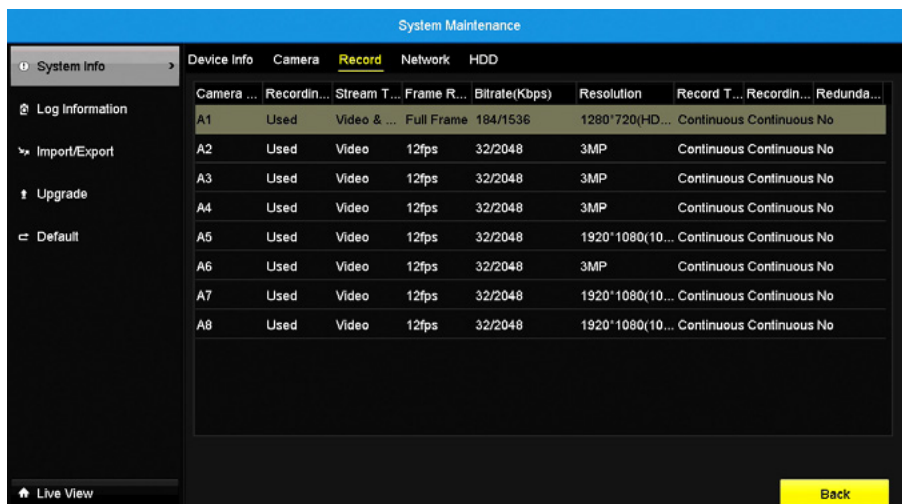

The screenshot shows the 'System Maintenance' interface with the 'Record' tab selected. A table lists the recording settings for eight cameras (A1 through A8). The table columns are: Camera, Recording Status, Stream Type, Frame Rate, Bitrate (Kbps), Resolution, Record Type, Recording Mode, and Redundancy.

Camera	Recording Status	Stream Type	Frame R...	Bitrate(Kbps)	Resolution	Record T...	Recordin...	Redunda...
A1	Used	Video & ...	Full Frame	184/1536	1280*720(HD...	Continuous	Continuous	No
A2	Used	Video	12fps	32/2048	3MP	Continuous	Continuous	No
A3	Used	Video	12fps	32/2048	3MP	Continuous	Continuous	No
A4	Used	Video	12fps	32/2048	3MP	Continuous	Continuous	No
A5	Used	Video	12fps	32/2048	1920*1080(10...	Continuous	Continuous	No
A6	Used	Video	12fps	32/2048	3MP	Continuous	Continuous	No
A7	Used	Video	12fps	32/2048	1920*1080(10...	Continuous	Continuous	No
A8	Used	Video	12fps	32/2048	1920*1080(10...	Continuous	Continuous	No

DISCLAIMER: Data shown above is for example purposes only.

8.7.1 (d) Network

In this section of the menu, you can view your current network settings.

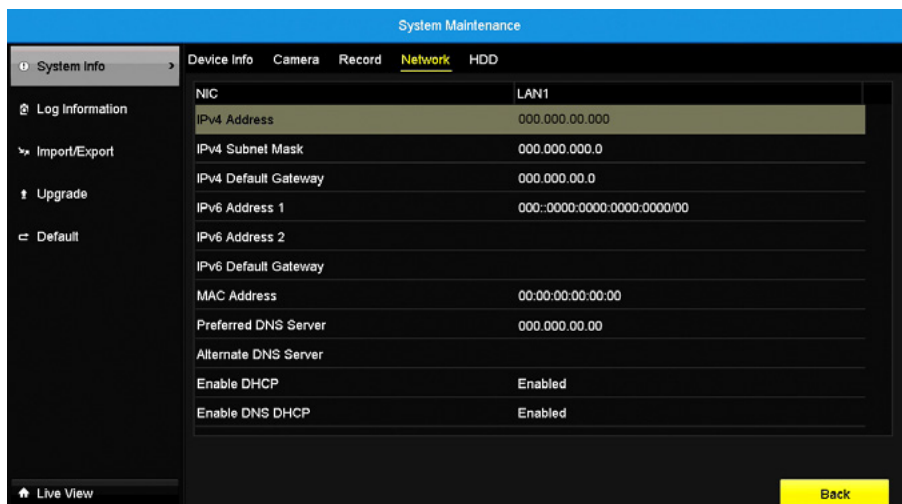

The screenshot shows the 'System Maintenance' interface with the 'Network' tab selected. It displays the network configuration for the LAN1 NIC. The settings include IPv4 and IPv6 addresses, subnet masks, default gateways, MAC address, and DNS servers.

Parameter	Value
NIC	LAN1
IPv4 Address	000.000.00.000
IPv4 Subnet Mask	000.000.000.0
IPv4 Default Gateway	000.000.00.0
IPv6 Address 1	000.:0000:0000:0000:0000/00
IPv6 Address 2	
IPv6 Default Gateway	
MAC Address	00:00:00:00:00:00
Preferred DNS Server	000.000.00.00
Alternate DNS Server	
Enable DHCP	Enabled
Enable DNS DHCP	Enabled

8.7.1 (e) HDD

In this section of the menu, you can check on the status of hard drives connected to the DVR.

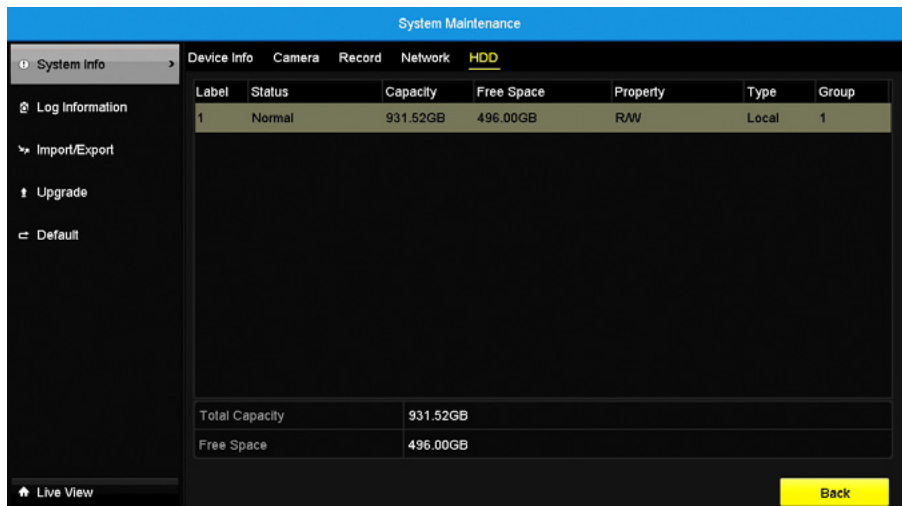

The screenshot shows the 'System Maintenance' interface with the 'HDD' tab selected. A table displays the status of the hard drive, and summary statistics are shown below.

Label	Status	Capacity	Free Space	Property	Type	Group
1	Normal	931.52GB	496.00GB	R/W	Local	1

Total Capacity	931.52GB
Free Space	496.00GB

8.7.2 Log Information

The DVR continuously creates information logs for every alarm event, operation and exception as they happen. These logs are stored in the DVR's hard drive and can be viewed and exported at any time.

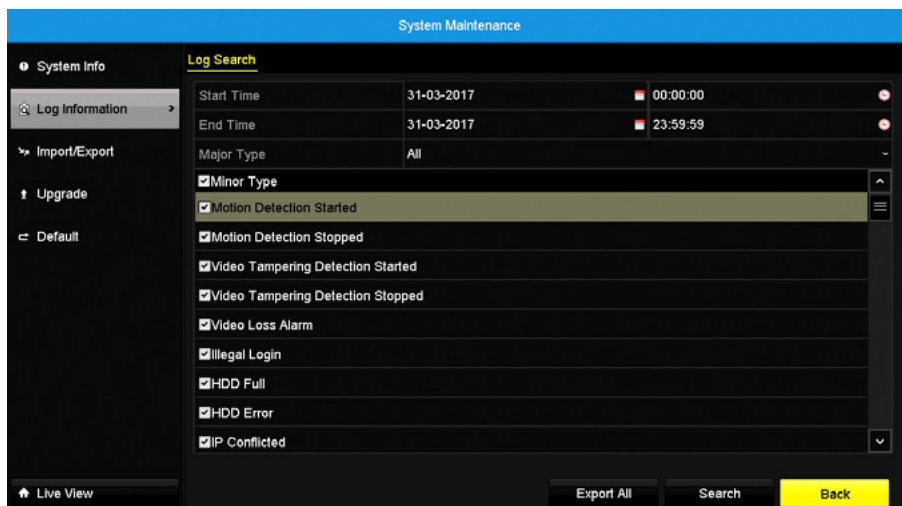

The screenshot shows the 'System Maintenance' interface with the 'Log Search' tab selected. It displays search criteria and a list of log types.

Start Time: 31-03-2017 00:00:00
End Time: 31-03-2017 23:59:59
Major Type: All

- Minor Type
 - Motion Detection Started
 - Motion Detection Stopped
 - Video Tampering Detection Started
 - Video Tampering Detection Stopped
 - Video Loss Alarm
 - Illegal Login
 - HDD Full
 - HDD Error
 - IP Conflicted

To Export logs: Click Search and Export.

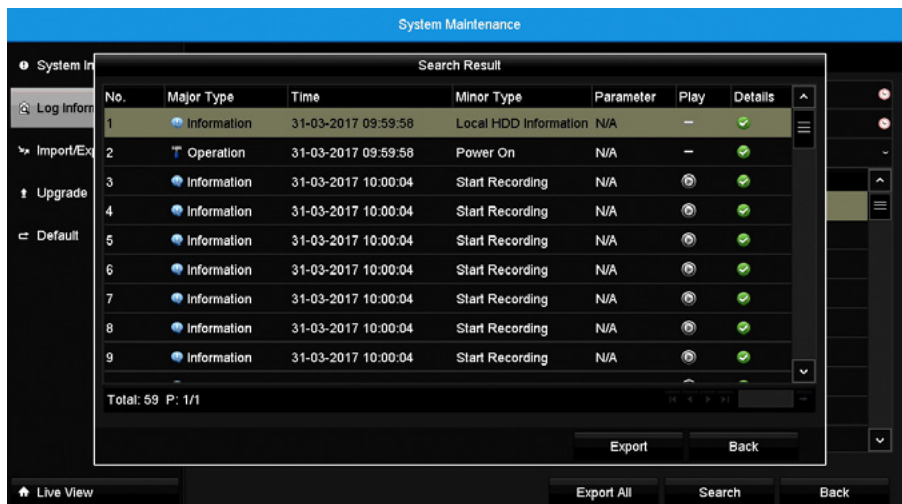

8.7.3 Import/Export

In this section of the menu, you can export or import a configuration file containing all the DVR settings you have customized, including your recording settings, schedule, and so on using a USB storage device. This will come in handy as it will save you time if you need to reset the DVR back to factory default settings.

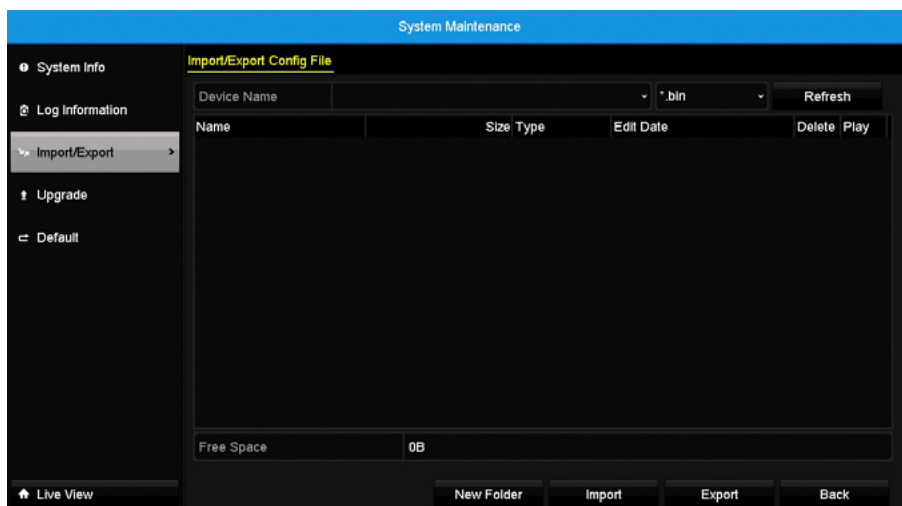

NOTE: This feature is for advanced users ONLY! Unless directed by a technical support agent, please disregard this menu screen.

8.7.4 Upgrade

In this section of the menu, you can upgrade the firmware of the DVR by using a USB storage device.

NOTE: This feature is for advanced users only, unless directed by a technical support agent, please disregard this menu screen.

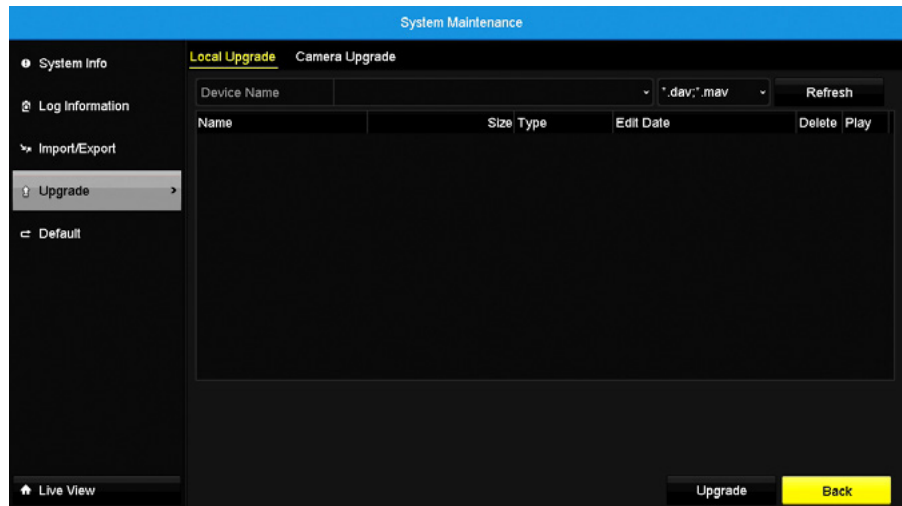

How to upgrade DVR firmware using a USB device:

- 1 Connect a USB storage device containing the firmware update file to the USB port on the back of the DVR.
- 2 Click Refresh. In the Device Name list, make sure your USB device is the current selection.
- 3 Select the firmware update file, and then click Upgrade. Once the update is complete, the DVR reboots automatically.

NOTE: DO NOT power off the DVR during firmware update process as it will cause damage to your unit.

8.7.5 Default

Within this section of the menu, you can restore the factory default settings of your DVR system.

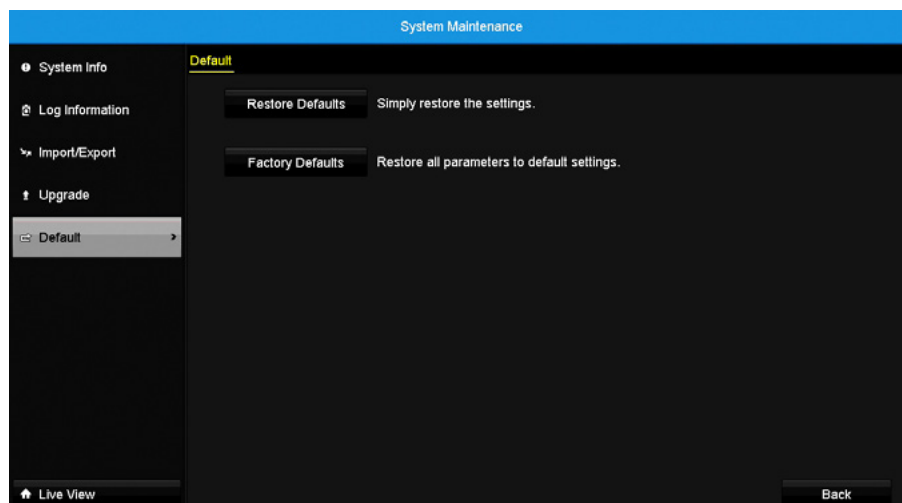

You can reset the DVR and load factory default settings. There are two options available:

Factory Default: Will reset all the parameters including network and user settings.

Restore Defaults: Will do the same but will maintain your network and user settings.

The DVR will reboot after you click Yes.

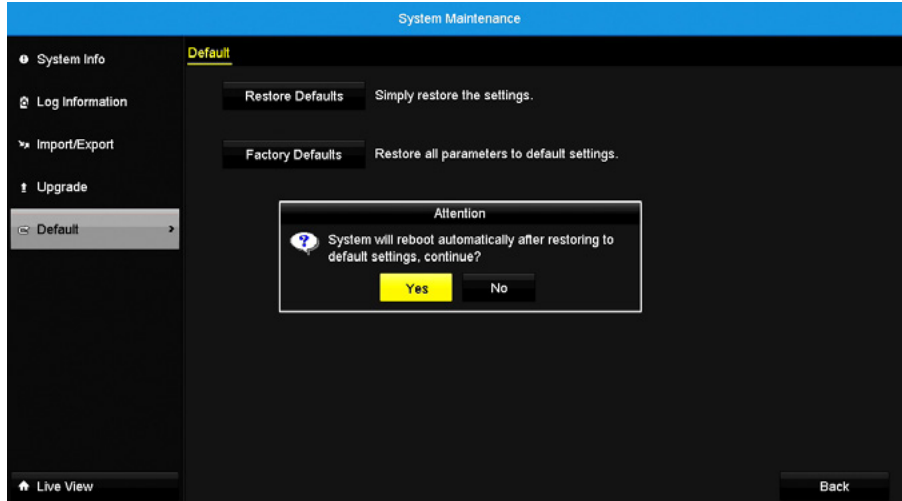



CHAPTER 9

GLOSSARY

Chapter 9: Glossary

DDNS: Dynamic Domain Naming System. Method for automatically updating hostnames, address or other information like a URL on a given name server.

DHCP: Dynamic Host Configuration Protocol. A network protocol that allows a server to automatically assign a device and IP address.

IP: Internet Protocol. Protocol for standard communications across the Internet.

ISP: Internet Service Provider. An organization that provides services for accessing or using the Internet.

OSD: On Screen Display.

PIR: Passive Infrared. Heat-based sensors eliminate most false alarms and only delivers alerts when people, animals or vehicles are detected.

SMTP: Simple Mail Transfer Protocol. Standards used for email transmission.

UPS: Uninterrupted Power Supply. Device used to keep the DVR and cameras powered when the main power supply is lost or disconnected.

UTC (Up-the-Coax): This new technology allows for PTZ functions to be sent back and forth between the DVR and camera using a standard BNC (Video/Power) cable without the need for a separate port.

THD: Hi-Definition Analog. Delivering crisp and clear HD images over coaxial cable.

CHAPTER 10

WARRANTY

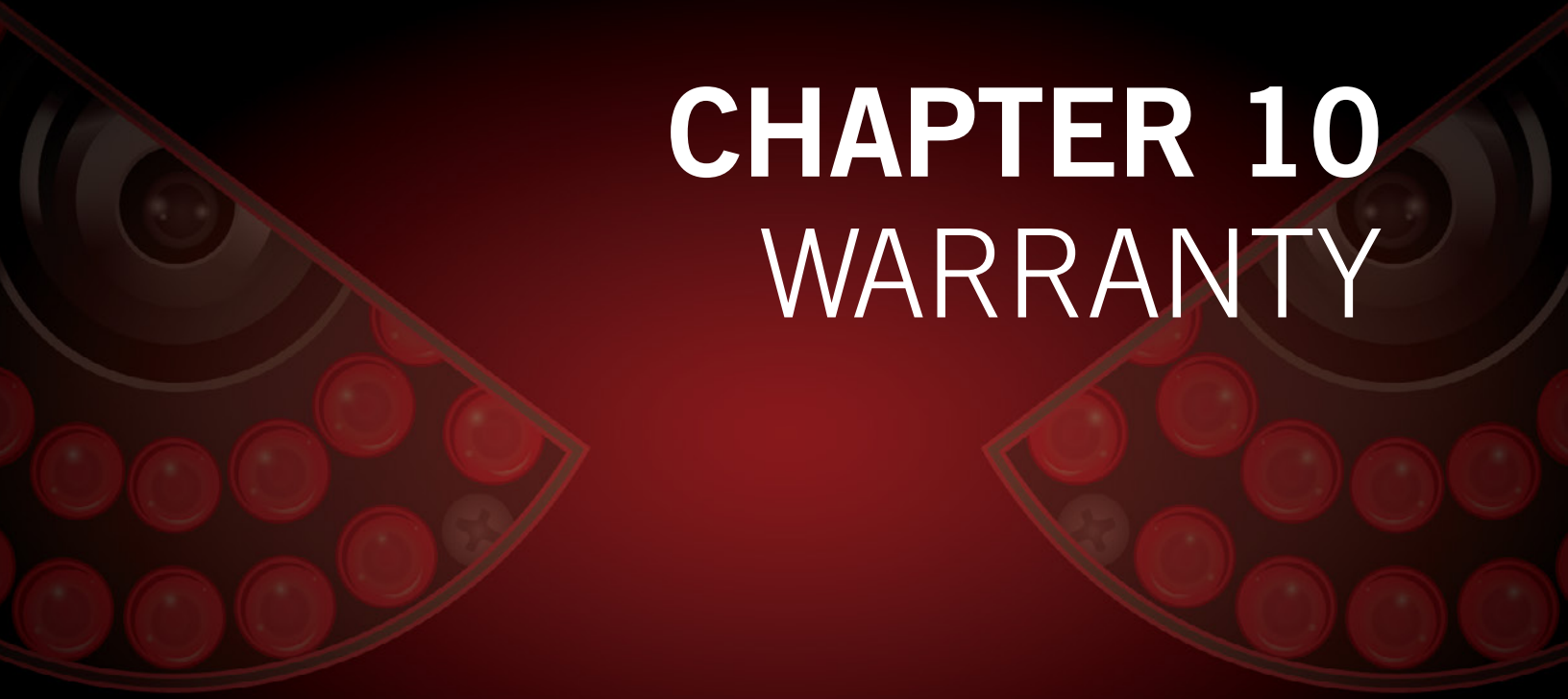

Chapter 10: Warranty

NIGHT OWL, LLC (“Night Owl”) provides the following warranty to the original retail purchaser only (the “Purchaser”) with respect to this product (the “Product”):

For a period of one (1) year after the date of sale, the Product shall be free from manufacturing defects in material and workmanship. In the event that the Product is defective, the Purchaser must return the Product at Purchaser’s cost (no CODs) to the address below, with the original proof of purchase receipt. In its sole discretion, Night Owl will either repair or replace the Product at no additional cost to the Purchaser. Any replacement Product (or parts) will be covered by the same warranty as the original Product through the expiration date of the original warranty period.

Exclusions

This warranty does not apply to the following parts or upon the following events:

1. Bulbs, LEDS and batteries;
2. The Product was not used or installed in the manner described in the installation instructions;
3. Negligent use of the Product or misuse or abuse of the Product;
4. Electrical short circuits or power surges;
5. Use of replacement parts not supplied by Night Owl;
6. Product is either tampered with, modified or repaired by another service provider;
7. Product has not been maintained in accordance;
8. Accident, fire, flood or other acts of God;
9. Failure to use Night Owl approved accessories;
10. Defects or damages arising by use of the Product in other than normal conditions (including normal atmospheric, moisture and humidity conditions).

Except as otherwise prohibited by law, this warranty is in lieu of other warranties, express or implied and Night Owl neither assumes nor authorizes any person to assume for it any other obligation or liability in connection with the sale or service of the Product.

In no event shall Night Owl be liable for any special or consequential damages arising from the use of the Product or arising from the malfunctioning or nonfunctioning of the Product or for any delay in the performance of this warranty due to any cause beyond its control. This warranty shall not apply to installation or the removal and re-installation of products after repair.

Night Owl does not make any claims or warranties of any kind whatsoever regarding the Product’s potential, ability or effectiveness to prevent, minimize or in any way affect personal or property damage or injury. Night Owl is not responsible for any personal damage, loss or theft related to the Product or to its use for any harm, whether physical or mental related thereto. Any and all claims or statements, whether written or verbal, by salespeople, retailers, dealers or distributors to the contrary are not authorized by Night Owl and do not affect this provision of this warranty.

Returns Under This Warranty

In order to obtain service, please make sure that you have registered your product on-line no later than thirty (30) days after purchase at www.NightOwlSP.com in the warranty registration section or in any other manner described in the instructions.

Disclaimer

Certain uses, publication and/or distribution of video/audio recordings from security cameras and/or audio devices are prohibited or restricted by federal, state and local laws. When enabling and/or using audio recording features with your hidden security camera, be sure to comply with the laws in your country, state and locality.

Mac and Mac OS X are registered trademarks of Apple Inc. Windows, Windows XP, Windows Vista, Windows 7, Windows 8 and Windows 10 are registered trademarks of Microsoft Corporation in the United States and/or other countries.



CHAPTER 11

TROUBLESHOOTING

Chapter 11: Troubleshooting

If a problem occurs, you may be able to easily correct it yourself. The following table describes some common issues and their most likely solutions. Please refer to the table before calling technical support.

Error	Possible Causes	Solutions
System is not receiving power or is not powering up.	Cable from power adapter is loose or is unplugged.	<ol style="list-style-type: none"> 1. Confirm that all cables are connected correctly. 2. Confirm that the power adapter is securely connected to the back of the unit.
	Cables are connected, but system is not receiving sufficient power.	<ol style="list-style-type: none"> 1. Confirm that the system is powered ON (LED indicators on the front should be ON). 2. If the unit is connected through a power bar or surge protector, try bypassing the bar and connecting the power directly to the wall outlet. 3. Confirm that there is power at the outlet. 4. Connecting the power cable to another outlet. 5. Test the outlet with another plugged device (such as a phone charger).
Hard drive is full (0%) and the unit is no longer recording.	Overwrite is not enabled.	Go to the Record Menu > Overwrite Recordings and ensure that Overwrite is selected.
Mouse not detected by system.	Mouse cable is not firmly connected to the system.	Firmly connect the mouse cable to the USB Mouse port on the front panel.
	Mouse is not connected to the system.	
	System needs to be reset.	Power off the system (disconnect power cable). Firmly connect a USB mouse to the USB Mouse port on the front panel of the system. Reconnect the power cable to the DC 12V port on the rear panel.

Error	Possible Causes	Solutions
There is no picture on selected channels/camera picture is not being displayed.	Camera cables are loose or have become disconnected.	<ol style="list-style-type: none"> 1. Check the camera video cable and connections. 2. Disconnect and reconnect the cable at the system and at the camera. 3. Try moving the camera to another channel or use another cable.
The image on the DVR appears, but does not have sound.	Audio cables are loose or have been disconnected.	Check the AUDIO connection to the DVR.
	Audio channels are disabled.	Left click on a channel in Live View to open the Channel Toolbar to locate Volume control and ensure that the channel(s) are not low or muted.
	Volume on external speakers (not included) is low or off.	Increase volume on external speakers (not included).
The system beeps at startup.		The beep at startup is normal.



CHAPTER 12

USER INFORMATION

Chapter 12: User Information

Be sure to write down all the important information below and place it in a secure location.

General DVR Information

NOTE: The Mac Address can be found within the Network tab of your DVR's Maintenance Menu. The Component Model Number can be found within the Device Info tab of your DVR's Maintenance Menu.

Admin Password: _____

User Password: _____

Mac Address: _____

Component Model Number: _____

Internet Login Information

NOTE: This information can be found within the Network tab in your DVR's Configuration Menu.

IPv4 Address: _____

IPv4 Subnet Mask: _____

IPv4 Gateway: _____

DNS1: _____

DNS2: _____



Need Help?

For system manuals, troubleshooting guides, FAQs, video tutorials and more:

Please refer to the sticker located on top of the device for steps on how to access your product's support material.



CONTACT US

PHONE (English, Spanish & French)

Sales / Technical Support

1.866.390.1303

Live Chat 24/7, 365 days a year

EMAIL

Sales Support

Sales@NightOwlISP.com

Technical Support

Support@NightOwlISP.com

WEBSITE

24/7 Product Support

- How-To Videos
- Manuals

www.NightOwlISP.com



iPhone, iPad, Mac and Mac OS X are registered trademarks of Apple Inc.
Windows, Windows XP, Windows Vista, Windows 7, Windows 8 and Windows
10 are registered trademarks of Microsoft Corporation in the
United States and/or other countries.

Rev 180716