



VIKING

User Guide

Wine Cellar

FDWCIC7240L - FDWCIC7240R

1. IMPORTANT SAFETY AND ENVIRONMENTAL INFORMATION	6
1.1. For your safety.....	6
1.2. Important information when using the appliance.....	7
1.3. Caring for the environment	8
1.4. Cleaning, sanitization and maintenance	8
1.5. Information for regulatory authorities.....	8
1.6. To save energy.....	8
2. INSTALLATION	9
2.1. Installation	9
2.2. Connection to the electrical power supply	9
2.3. Refrigerant.....	9
3. BEFORE STARTING	10
3.1. Getting started.....	10
3.2. Manufacturer's liability.....	10
3.3. Technical support	10
3.4. Product plate.....	10
3.5. Main components.....	11
3.6. Electronic Control.....	12
3.7. Main control panel.....	12
4. TURNING THE APPLIANCE ON AND OFF	13
4.1. Turning on and off	13
5. COMPARTMENT TEMPERATURE SETTING	15
5.1. How to adjust the compartment temperature.....	15
5.2. Information and malfunction messages on the display.....	16
5.3. Wine storage temperatures	16
6. FUNCTIONS AND SETTINGS	17
6.1. Functions	17
6.2. Settings.....	18
7. LAYOUT	23
8. LIGHTING	23
7.1. Internal layout (positioning, adjustment, removal).....	23
8.1. Lighting	23
9. CONSERVATION OF WINES	24
9.1. General directions.....	24
9.2. Storage temperatures	24
9.3. Time of conservation.....	25
9.4. Consumption temperature.....	26
9.5. Positioning the bottles	27
10. CARE AND CLEANING	27
10.1. Care and Cleaning	27
10.2. Internal cleaning.....	28
10.3. Cleaning of the ventilation grill, filter and condenser.....	28
10.4. Lower condenser.....	29
11. TROUBLESHOOTING	30
11.1. Troubleshooting Guide	30
11.2. Malfunction messages appearing on the display	31



This is the safety alert symbol. This symbol alerts you to potential hazards that can kill or hurt you and others. All safety messages will follow the safety alert symbol and either the word "DANGER" or "WARNING."

These words mean:



You can be killed or seriously injured if you don't follow instructions.



You can be killed or seriously injured if you don't immediately follow instructions.

All safety messages will tell you what the potential hazard is, tell you how to reduce the chance of injury, and tell you what can happen if the instructions are not followed.

SAVE THESE INSTRUCTIONS!



IMPORTANT SAFETY INSTRUCTIONS

This manual contains operational instructions for the users of the appliance. Keep this manual in an easily accessible place for future reference. Improper installation, adjustment, alteration, service or maintenance can cause property damage, injury, or death.

Read the installation, operating, and maintenance instructions thoroughly before installing or servicing this equipment.

To reduce risk of fire, electric shock, or injury to persons when using your appliance, follow basic precautions, including the following:

- > Children should be supervised to ensure that they do not play with the appliance.
- > This appliance is not intended for use by persons (including children) with reduced physical, sensory or lack of experience and knowledge unless they have been given supervision or instruction concerning use of the appliance by a person responsible for their safety.
- > This appliance is designed to refrigerate beverages and foods and is intended for domestic use.
- > This appliance is intended to be used in household and similar applications such as: staff kitchen areas in shops, offices, and other working environments; farm houses and by clients in hotels, motels, and other residential-type environments; bed and breakfast-type environments; and catering and similar non-retail applications.
- > Do NOT use an extension cord or adapter.
- > Plug into a grounded 3 prong outlet.
- > Do not remove ground prong.



In the event of a power failure, do not attempt to operate this appliance.



Keep the appliance area free and clear from combustibles or flammable materials and vapors.



Keep ventilation openings, in the appliance enclosure or in the built-in structure, clear of obstruction. Do not obstruct the air intake or exhaust openings of the appliance.



Do not store explosive substances such as aerosol cans with a flammable propellant in this appliance.



Do not use electrical appliances inside the food storage compartments of the appliance, unless they are of the type recommended by the manufacturer.

IMPORTANT SAFETY INSTRUCTIONS FOR PROPER DISPOSAL OF YOUR OLD REFRIGERATOR

▲WARNING

Suffocation Hazard

Remove doors or lid from your old appliance.

Failure to do so can result in death or brain damage.

▲WARNING Risk of child entrapment.

Before you throw away your old refrigerator or freezer:

- > Take off the doors.
- > Leave the shelves in place so that children may not easily climb inside.
- > **IMPORTANT:** Child entrapment and suffocation are not problems of the past. Junked or abandoned refrigerators are still dangerous, even if they will sit for "just a few days." If you are getting rid of your old refrigerator, please follow these instructions to help prevent accidents.

Important information to know about disposal of refrigerants:

Dispose of refrigerator in accordance with federal and local regulations. Refrigerants must be evacuated by a licensed, EPA-certified refrigerant technician in accordance with established procedures.

IMPORTANT SAFETY INSTRUCTIONS FOR MAINTENANCE AND CARE

▲DANGER Risk of fire or explosion due to puncture of refrigerant tubing; follow handling instructions carefully. Flammable refrigerant used.

▲WARNING To be repaired only by trained service personnel. Use only manufacturer-authorized service parts. Do not use replacement parts that have not been recommended by the manufacturer (e.g., parts made at home using a 3D printer). If power supply cord is damaged, it must be replaced by the manufacturer, its service agent, or a similarly qualified person in order to avoid a hazard. Any repair equipment used must be designed for flammable refrigerants. Follow all manufacturer repair instructions. Use nonflammable cleaner.

▲WARNING Do not puncture refrigerant tubing, do not damage the refrigerant circuit.

▲WARNING Do not use mechanical devices or other means to accelerate the defrosting process, other than those recommended by the manufacturer.

TIP OVER HAZARD

▲WARNING Refrigerator is top heavy and tips easily when not completely installed; to avoid a hazard due to instability of the appliance, it must be fixed in accordance with the instructions (see instruction manual provided). Keep doors taped closed until refrigerator is completely installed.

Use two or more people to move and install refrigerator.

Failure to do so can result in death or serious injury.

1. IMPORTANT SAFETY AND ENVIRONMENTAL INFORMATION

1.1. For your safety

- > If this appliance is replacing an existing appliance which must be removed or disposed of, make sure that it does not become a dangerous trap for children by cutting its power supply cable and rendering it impossible to close the door.
- > This appliance is designed to refrigerate beverages and foods and is intended for domestic use.
- > This appliance is for refrigeration and conservation of fresh foods in the home. Any other use is considered inappropriate.
- > This appliance is not designed to operate with external timers or with remote-control systems.
- > The appliance must be installed by following the instructions in the Installation Guide, particular care should be taken not to **obstruct the vent openings of the appliance and of the built-in units**.
- > The appliance features a concentrated lighting system with LED lamps. Do not stare at these lamps when they are on, as this could damage your vision.
- > This warning is also included on the label attached to the inside of the refrigerator door.
- > Do not use any type of electrical equipment inside the appliance.
- > When positioning the shelves, do not place fingers in the shelf slide guides.
- > Do not position containers of flammable liquids near the appliance.
- > Never attempt to extinguish a flame/fire with water: unplug the appliance from the outlet and cover the flame with a fireproof blanket.
- > Do not position containers of flammable liquids near the appliance.
- > Completely switch off the appliance and unplug the power supply cable during cleaning operations. If the plug is not easily reached, it is a good idea to turn off the circuit breaker that corresponds to the outlet which the unit is plugged into.
- > Packaging materials can be dangerous for children: do not allow children to play with plastic bags, plastic film or polystyrene.
- > Any repairs must be performed by a qualified service technician.
- > This appliance is not intended for use by persons (including children) with reduced physical, sensory or mental capabilities or lack of experience and knowledge unless they have been given supervision or instruction concerning the use of the appliance by a person responsible for their safety. Children should be supervised to ensure that they do not play with the appliance.
- > Do not damage the appliance's refrigerant circuit

tubing.

- > Do not store explosive substances, such as aerosol cans with a flammable propellant, inside this appliance.
 - > The amount of refrigerant gas contained in your appliance is indicated on the identification plate located inside the appliance. If the power cord of this appliance is damaged, it must be replaced by the manufacturer, customer service or a similarly qualified person.
 - > Improper installations and repairs may put the user at considerable risk.
 - > Repairs must be carried out by the authorized customer service.
 - > Only original spare parts from the manufacturer can be used. Only with the use of these components does the manufacturer guarantee that the safety requirements of the product are complied with.
 - > Repairs may be performed by the manufacturer, authorized customer service or a similarly qualified person only.
 - > Plug the appliance into a grounded 3-poles outlet.
 - > Do not remove the ground pole.
 - > Do not use an adapter.
 - > Do not use an extension cord.
 - > Disconnect power to all units before servicing.
 - > If the POWER CORD is damaged, it must be replaced by the manufacturer, an authorized service centre or a similar qualified person in order to avoid any hazards.
 - > Children must be supervised to make sure they do not play with the appliance.
 - > Do not modify this appliance.
 - > Do not insert pointed metal objects (kitchen utensils or tools) into the slots in the appliance.
 - > Do not touch (especially with wet hands) frozen products or put them in your mouth directly.
 - > Do not store flammable, explosive or volatile substances inside the appliance.
 - > Do not store explosive substances, such as spray bottles with flammable propellants, in the appliance.
 - > Bottles containing beverages with a high alcohol content must be tightly closed and stored vertically.
 - > Organic compounds, acids and essential oils can corrode the seals and plastic surfaces if left in contact with them for extended periods.
 - > Do not pull on the cable to unplug the appliance.
-

1.2. Important information when using the appliance

- > Cleaning and maintenance meant to be performed by the user must not be carried out by unsupervised children.
 - > Never defrost or clean the appliance with a steam cleaner! The steam may penetrate electrical parts and cause a short-circuit. Risk of electric shock!
 - > Do not use pointed or sharp-edged implements to remove frost or layers of ice. You could damage the refrigerant tubes.
 - > Leaking refrigerant may cause eye injuries or ignite.
 - > Do not misuse the plinth, pull-out drawers, doors, etc. as a point of support or as a support.
 - > Take care that no objects get stuck in the doors.
 - > Before cleaning the appliance, pull out the power cord plug or turn off the safety switch. Do not pull out the power cord plug by tugging on the power cord.
 - > Store high-percentage alcohol tightly closed and standing up.
 - > Keep plastic parts and the door seal free of oil and grease. Otherwise, parts and door seal will become porous.
 - > Never cover or block the appliance's ventilation openings.
 - > Do not damage the cooling circuit (if it can be accessed).
 - > Do not use electrical appliances inside the appliance.
 - > In the event of damage to the cooling circuit, avoid the use of open flames and ventilate the area properly.
 - > Do not use the appliance or parts of it in any way other than those specified in this manual.
 - > Keeping the door open for long periods can cause the temperature in the appliance compartments to rise considerably.
 - > Perform cleaning of surfaces that may come into contact with food and accessible drainage systems regularly.
 - > Store raw meat and fish in suitable containers in the refrigerator, so that it does not come into contact with other food or drip onto it.
 - > If the appliance is left empty for long periods of time, switch it off, defrost it, clean it, dry it and leave the door open to prevent the development of mold inside.
 - > Never place sharp metal objects such as knives, forks, spoons and lids on the appliance during use.
 - > Do not use abrasive or corrosive cleaning agents (e.g. scouring powders, stain removers or metallic scouring pads and sponges) on glass parts.
 - > Do not sit on the appliance.
 - > Do not sit or lean on the door or on any open drawers.
 - > Do not put pressure on the door or handle to move the appliance.
- > Do not use electrical appliances (e.g. hair dryers) or sprays for defrosting which may ruin the plastic parts.
 - > Do not use the appliance to cool rooms for any reason.
 - > Always unplug the appliance in the event of a malfunction or when performing cleaning or maintenance.
 - > Do not keep liquids in tins or glass containers in the freezer.
 - > Do not place heavy objects on top of the appliance

1. IMPORTANT SAFETY AND ENVIRONMENTAL INFORMATION

Symbols used in the Guide:



Note

Tips for the correct use of the appliance



Important

Directions to avoid appliance damage



Warning

Directions to prevent injury

1.3. Caring for the environment



- > This appliance must be disposed of separately from other waste at the end of its service life. Refer to local laws and regulations.
- > This appliance does not contain substances in quantities sufficient to be considered hazardous to health and the environment.
- > Make sure you dispose properly of all packing materials and refer to local laws and regulations.



Electric voltage | Electrocutation hazard

Disconnect the mains power supply. Unplug the appliance.

- > The appliance must not be disposed of with other waste. Contact local waste disposal centres about how to dispose of recyclable waste.
- > Prior to disposal, cut the power supply cord and remove the door and/or drawers.
- > During disposal, avoid damage to the refrigeration circuit.
- > Neither the refrigeration circuit nor the insulation contain substances that are damaging to the ozone layer
- > Our appliances are packaged in non-polluting and recyclable materials.
- > Deliver the packing materials to the appropriate recycling centre.



Plastic packaging | Choking hazard

Do not leave the packaging or any part of it unattended.

Do not let children play with plastic bags.

1.4. Cleaning, sanitization and maintenance

- > Any work on the appliance must be carried out by a qualified Viking Service technician.



Warning

To avoid contamination of food, please respect the following instructions:

- > Opening the door for long periods can cause a significant increase in temperature inside the appliance compartments.
- > Perform regular cleaning of surfaces that may come in contact with food and of accessible drainage systems.
- > Store raw meat and fish in suitable containers in the refrigerator, so that it does not come into contact with other food or drip onto it.
- > Two-star frozen-food compartments are suitable for storing pre-frozen food, storing or making ice cream and making ice cubes.
- > One-, two- and three-star compartments are not suitable for the freezing of fresh food.
- > If the refrigerator is left empty for a long period, switch it off, defrost, clean and dry it, and leave the door open to prevent mould developing within the appliance.

1.5. Information for regulatory authorities

- > Ventilation requirements, dimensions and minimum space from the rear wall are provided in the "Installation" chapter of this manual.
- > Contact Viking for additional information.

1.6. To save energy

- > Correct use of the appliance, correct packaging of foodstuffs, a constant temperature and food hygiene all have effects on the quality of storage.
- > Keep the number of times that the doors are opened and the length of time they remain open to a minimum to avoid excessive warming.
- > Clean the condenser periodically to prevent the appliance from losing efficiency (see page 29).

2. INSTALLATION

2.1. Installation

Make sure that installation is performed correctly, adhering to all of the instructions in the specific installation guide provided with the appliance.



Warning

If any model has water connections, make them before connecting the machine to the electrical system.

- > The appliance must be connected to ground in compliance with local electrical code.
- > Position the wine cellar with the aid of a second person.
- > Never use the open door to lever the wine cellar into place.
- > Avoid exerting too much pressure on the door when open.
- > The wine cellar must not be installed near heat sources. If this is not possible, suitable insulation must be used.
- > The appliance must not be exposed to direct sunlight.
- > Do not use the appliance outdoors.
- > Installation and servicing should be carried out by qualified personnel in compliance with current standards.
- > Ensure that an a licensed electrician performs the electrical connection.
- > If the power supply cable is damaged, to avoid any danger, contact an authorized servicer immediately and they will replace it, so as to prevent any risk.
- > Always put on the necessary Personal Protective Equipment (PPE) before performing any work on the appliance (installation, maintenance, positioning or handling).
- > Before performing any operation involving the appliance, switch off the circuit breaker.
- > If installed near another refrigerator, refer to the installation guide.
- > Do not try to repair the appliance yourself, contact an authorized servicer.
- > Do not install/use the appliance outdoors.
- > WARNING: Make sure that the power supply cable does not become caught or damaged when positioning the wine cellar.
- > To prevent instability of wine cellar, install and secure it correctly as indicated in the instructions provided in this manual.
- > This wine cellar can be used up to a maximum height of 6000 feet/2000 meters above sea level.

2.2. Connection to the electrical power supply

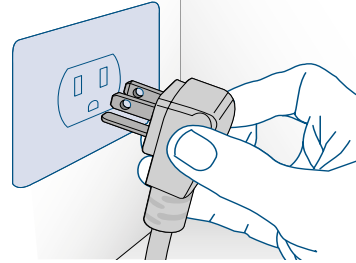

The appliance operates at 115 V AC, 60Hz and is equipped with a power supply cord with a 3-prong grounded plug, which must be connected to a corresponding 3-prong (15 Amp) grounding-type wall receptacle.



Important

Do not use extension cords and/or multiple adapters for connection.

2.3. Refrigerant

The refrigerant isobutane (R600a) is contained within the refrigerant circuit of the appliance, a natural gas with a high level of environmental compatibility, which is nevertheless flammable.

If the refrigerant circuit should become damaged, make sure that no flames and sparks develop in the room. Thoroughly ventilate the room in which the appliance is situated.



ISO 7010 W021

Warning

Fire hazard / Flammable materials.

Use special care during transportation, installation and/or cleaning so as to avoid damaging the refrigeration circuit.

3. BEFORE STARTING



Important

Take care during transport, assembly or cleaning so that the refrigerant circuit is not damaged.



Warning

Fire / Flammable materials hazard.

3.1. Getting started

Congratulations on having purchased your new Viking Wine Cellar. From now on you can use our innovative storage system, which will allow you to store all of your wine in the best possible way. This manual will answer most of your questions about the product's features.

3.2. Manufacturer's liability

The manufacturer declines all liability for injury or property damage caused by:

- > uses of the appliance other than those specified;
- > failure to comply with the instructions in the user manual;
- > tampering with any part of the appliance;
- > use of non-original spare parts.

3.3. Technical support

- > In the event of appliance failure, contact technical support and have the repair carried out by authorized servicer only.
- > Make sure you have the model and serial number on hand (located on the identification plate).
- > Use only original spare parts.
- > Do not try to repair the appliance yourself or without the assistance of an authorized servicer; this has safety repercussions and may void the warranty.
- > Detailed information on the duration of the warranty and the warranty conditions in each country can be found from our customer service, your dealer or on our website.
- > If you need further information, do not hesitate to contact the Customer Support Center:

Viking Range, LLC
111 Front Street,
Greenwood, Mississippi 38930 USA
1-888-845-4641
or visit the our web site at vikingrange.com



Important

Before calling, make a note of the appliance's serial number located inside the refrigerator compartment on the side opposite the door opening.

3.4. Product plate

The product plate shows the technical data, the serial number and the model. The product plate must never be removed or damaged.

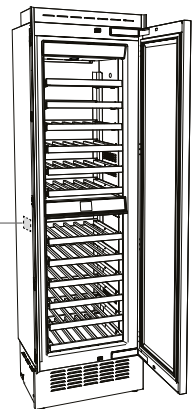

VIKING RANGE, LLC GREENWOOD, MISSISSIPPI 38930		LISTED HOUSEHOLD REFRIGERATOR Refrigerator-Fr						
MODEL/MODELE NUMBER/NUMERO	VKFDBMIC7360RA	VOLTS/FREQUENCY	115/60					
SERIAL/SERIE NUMBER/NUMERO	2525001050001	DEFROST SYSTEM WATTS	213					
REFRIGERANT TYPE	R600a	ICE MAKER ELEMENT WATTS						
BLOWING AGENT	HFO-1336mzz(Z)	CURRENT COOLING SYSTEM						
TOTAL GROSS VOLUME (L)	575	MAX. RATED CURRENT (A)	3,50					
FREEZING CAPACITY		REFRIGERANT TOTAL MASS (REFRIGERATOR/FREEZER)	(0,23 lbs (108 gms))					
REFRIGERANT CHARGE (oz) (gms)	<table border="1"> <tr> <td>FF</td> <td>FZ</td> </tr> <tr> <td>1,70 (48,00)</td> <td>2,10 (60,00)</td> </tr> </table>	FF	FZ	1,70 (48,00)	2,10 (60,00)	CLIMATE CLASS		
FF	FZ							
1,70 (48,00)	2,10 (60,00)							
WATER SUPPLY IN Mpa (bars), Min 0.15 (1.5) - Max 1								

Conservation Tips

- > SN (Subnormal) from +50°F to +90°F (+10° to +32°C).
- > N (Normal) from +61°F to +90°F (+16° to +32°C).
- > ST (Subtropical) from +64°F to +100°F (+18°C to +38°C).
- > T (Subtropical) from +64°F to +109°F (+18°C to +43°C).

3. BEFORE STARTING

3.5. Main components

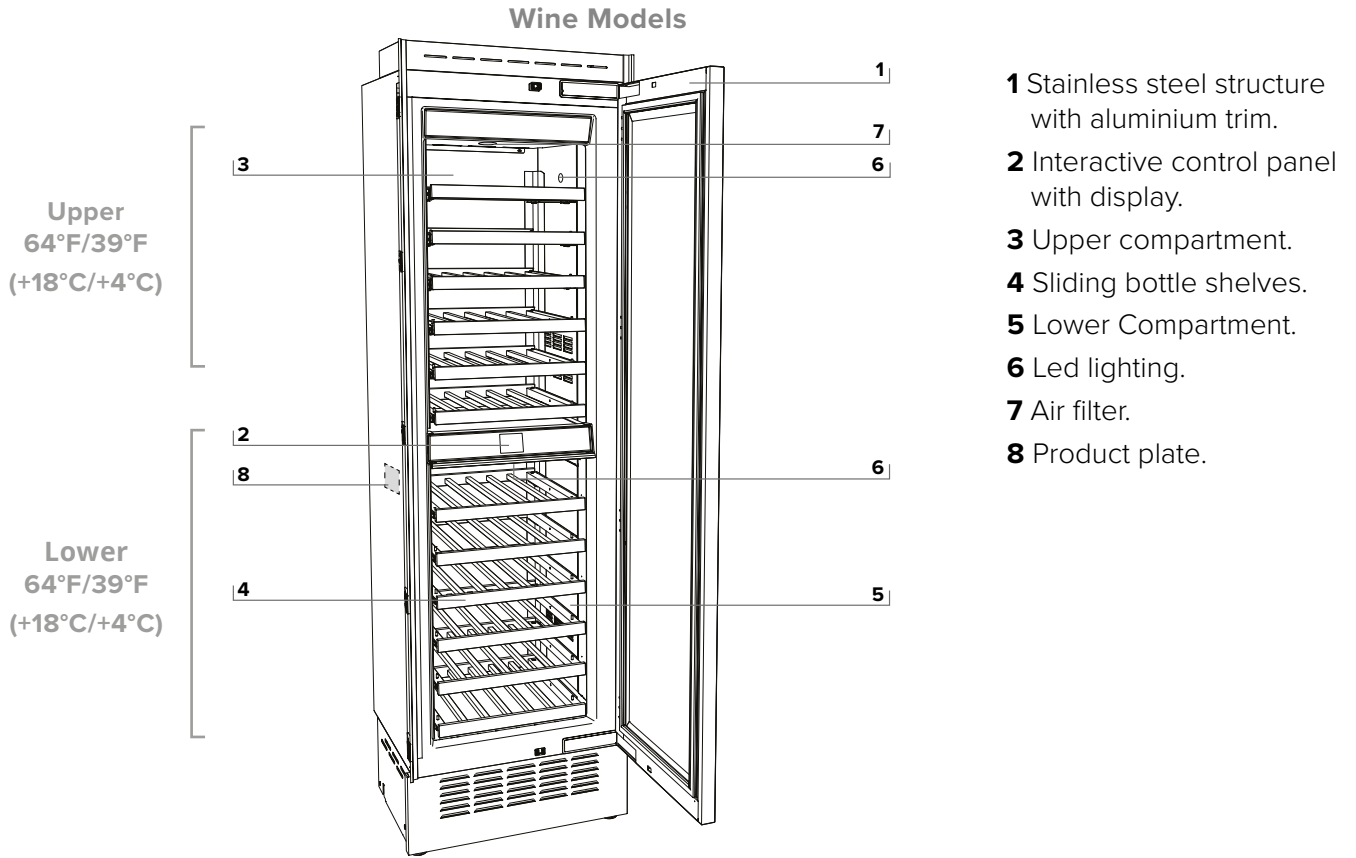

3. BEFORE STARTING

3.6. Electronic Control

The innovative electronic control system designed by Viking maintains constant temperature in the compartments and displays it on the control panel. It also allows user interaction making it possible to personalize settings of the various functions and to receive sound and/or visual messages should any malfunction occur in the appliance.

3.7. Main control panel

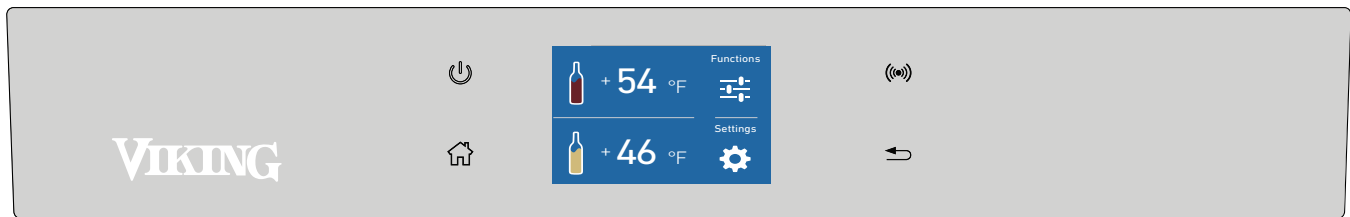

Turning On/Off

Touch the icon to turn the unit on or off.



Home

Touch the Home icon to go back to the home screen.



Alarm

Touch the icon to view the alarm tone functions and to deactivate them.



Back

Touch the arrow icon to go back to the previous screen.

4. TURNING THE APPLIANCE ON AND OFF

4.1. Turning on and off

First startup

Touch the **ON/OFF** . The display shows the following launch screens:



1) Manufacturer's logo

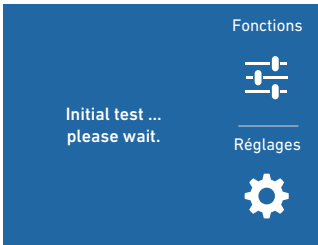

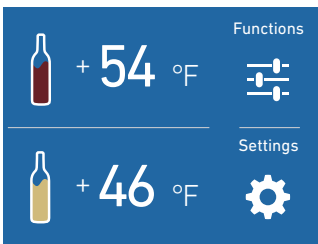

2) Initial test (lasts 3 minutes).

3) The display shows the main screen with the ambient temperature measured from the cellar inside the compartments. Automatically the unit start to cool down until reaching the set temperatures.



4) Home screen (*).

-  Upper compartment [+46°F(+8°C)]
-  Lower compartment [+41°F (+5°C)]

(* The home screen varies depending on the models; (see par. 5.1. How to adjust the compartment temperature page 15).

When the appliance is first turned on, it is recommended to wait at least 12 hours before placing any food inside the unit. During this time, deactivate any error messages by touching the **ALARM**  button.

Switching off the appliance

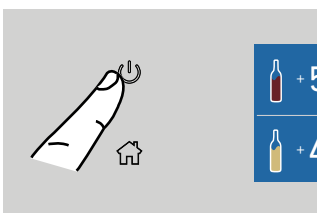

1) Touch the **ON/OFF** key  to switch off.

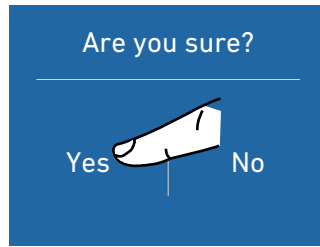

3) Confirm the shutdown touching the **YES** icon.



Note

When the unit is off there are no warning lights to show that the appliance is plugged into a socket.

Upper compartment and Lower compartment shutdown

The Upper compartment and the Lower compartment can be shutdown.

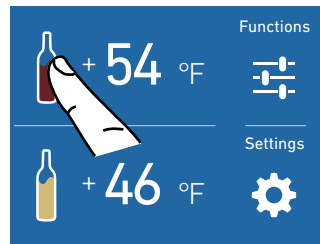

1) HOME screen. To turn off the Upper compartment or the Lower, touch the corresponding icon.

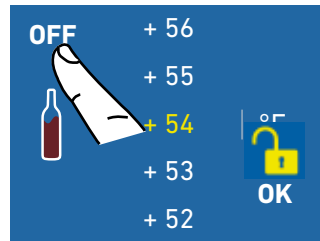

2) Touch the **OFF** icon.

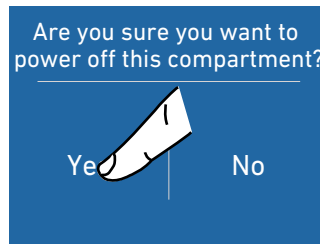

3) Confirm the shutdown touching the **YES** icon.

4. TURNING THE APPLIANCE ON AND OFF

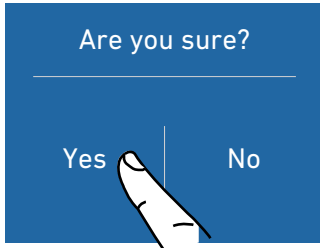

3) Confirm shutdown again touching the **YES** icon.

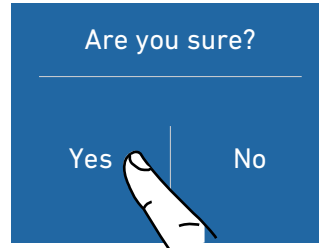

4) Confirm the turning on again touching the **YES** icon.

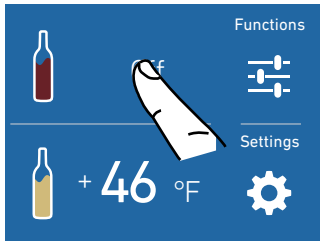

5) The home screen displays the **OFF** icon , to show the Upper compartment is off

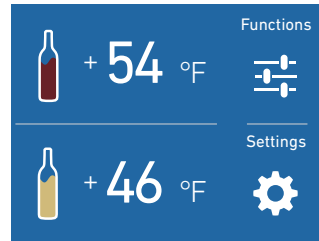

5) The compartment switches back on and the **HOME** screen is displayed.

To turn off the Lower compartment  follow the same procedure.

Turning the appliance back on

To turn the unit back on, press the **ON/OFF**  button. The display will turn on and the start screen and the home screen will be shown, once again displaying the temperature measured inside the compartments. The unit will start cooling until it reaches the set temperatures.

Switching the compartments back on

If the Upper compartment and the Lower compartment must be turned back on, follow this procedure:

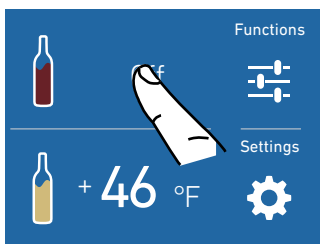

1) Home screen.
To turn back on an off compartment, touch the **OFF** compartment next to it.

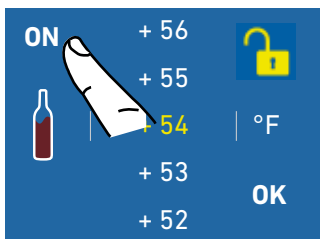

2) Touch the **ON** icon.

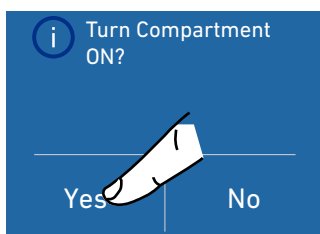

3) Confirm the turning on touching the **YES** icon.

To on the Lower compartment  again, follow the same procedure.

Turning off for long periods

During long periods of absence it is recommended that you turn off the appliance by pressing the **ON/OFF**  button and disconnecting the electrical plug or the breaker controlling the socket.

Empty the wine cellar completely, clean and dry it and leave the doors and drawers partially open to prevent unpleasant odours.



Note

If the word Viking does not appear at the first start, but other words appear, it means that the equipment has already started the cooling procedure.

During the first startup, it will not be possible to use the Menu to modify the factory settings until the preset temperature has been reached. It is however possible to set the time and date immediately; these parameters are required to activate some of the special functions. Each time the appliance is turned on, it goes through a self-diagnosis procedure lasting three minutes before starting up completely. If only the Upper or Lower compartment is turned off, the corresponding fan will continue to run independently to prevent the formation of unpleasant odours and mold.

5. COMPARTMENT TEMPERATURE SETTING

5.1. How to adjust the compartment temperature

Each model has been carefully tested before leaving the factory and is adjusted in such a way to ensure high performance and low consumption. Usually, it is not necessary to modify the settings.

How it looks to the home screen in the various models:

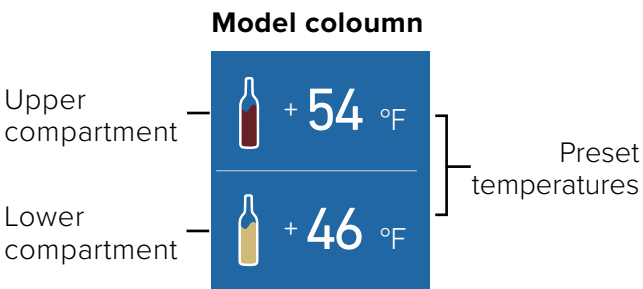

Modifying the compartment temperatures

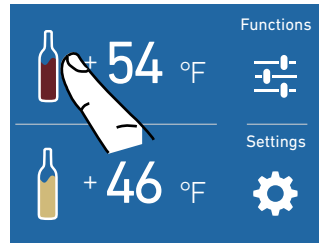

1) Home screen. Touch the cantina compartment icon  for example.

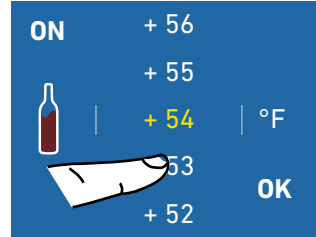

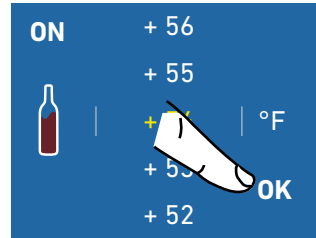

2) Scroll the values up or down to select the desired temperature (in the case of the cantina compartment the temperature can be set from 39°F (+4°C) to 64°F (+18°C)



3) Touch the **OK** icon to confirm the selected temperature.

The same procedure is required to set the temperature:

- > in the Upper  compartment from 39°F (+4°C) to 64°F (+18°C).
- > in the Lower  compartment from 39°F (+4°C) to 64°F (+18°C).



Note

The displayed temperature may vary slightly with respect to the set temperature if the doors are continuously opened or if large quantities at ambient temperature are inserted. It takes 6 to 12 hours to reach the selected temperature.

5. COMPARTMENT TEMPERATURE SETTING

Padlock icon

The padlock icon shows up when the temperatures are set up.

The padlock:

 **open** means that the compartment temperatures can be modified.

 **closed** means that the compartment temperatures cannot be modified.

Usually an open yellow padlock is displayed; in this case you can scroll up or down with a finger on the display, select the desired temperature and press **OK** to confirm.

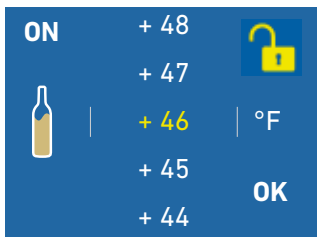

The padlock will instead be closed if the user has activated some functions (described in par. “6. FUNCTIONS AND SETTINGS” on page 17); in this situation, the user will no longer be able to change the temperatures of the compartments until the function is completed or if it is disabled manually.

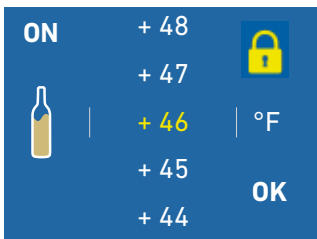

5.2. Information and malfunction messages on the display

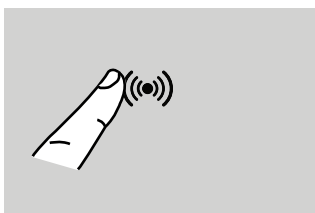

An integrated control system provides information through lighted signals or text messages visualized on the display. The sound that accompanies some of the anomaly warnings can be turned off by touching the

ALARM  button on the main control panel.

You can find the list of the anomalies at the end of this manual (see paragraph “11.2. Malfunction messages appearing on the display” page 31).

5.3. Wine storage temperatures

For better storage, wines need a different temperature, warmer for red wines, and colder for white wines.



Red Wine

from 50°F (+10°C)
to 64°F (+18°C)



White Wine

from 39°F (+4°C)
to 48°F (+9°C)

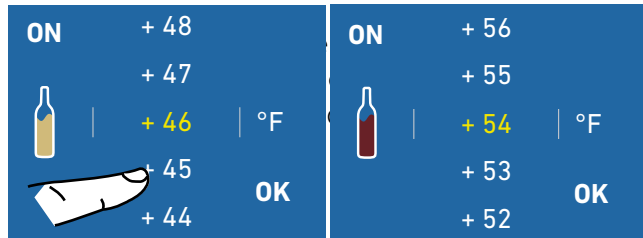

Burgundy
BOTTLE



Bordeaux
BOTTLE



6. FUNCTIONS AND SETTINGS

6.1. Functions

You can tailor the operation of your wine cellar to suit the different ways in which you might want to use it.

After touching the functions  icon on the home screen the icons with the following available functions will be shown.



1) Humidity.

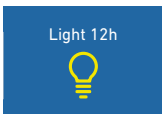

2) Internal light 12h.

1) Humidity

This function enables to set the humidity of the Upper and Lower compartments.

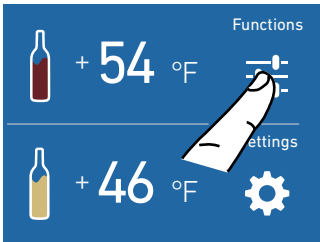

A) HOME screen. Touch the **FUNCTIONS** icon.

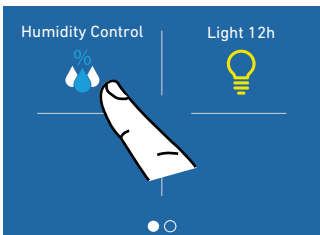

B) Scroll right twice and touch the **HUMIDITY** icon.

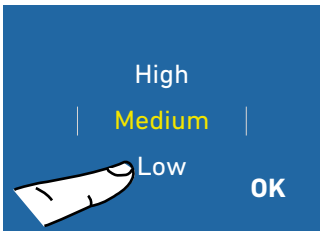

C) Scroll the values up or down to set the desired humidity.

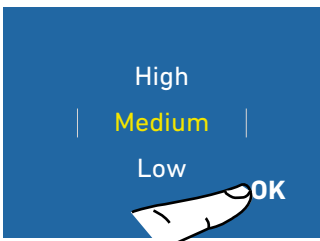

D) Press **OK**.

2) Internal lighting 12 h

This function enables to set the timing of the inner lighting and it stays on 12 hours when the wine cellar door is closed, in order to see the inner part lighted up, through the glass.

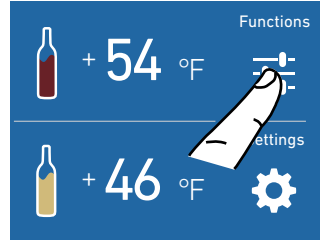

A) HOME screen. Touch the **FUNCTIONS** icon.

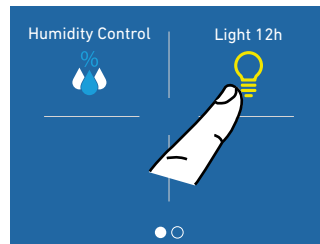

B) Scroll right twice and touch the **LIGHT 12H** icon.

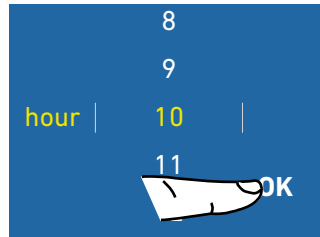

C) Touch the **OK** button to activate the function.

6. FUNCTIONS AND SETTINGS

6.2. Settings

It is possible to customize the settings of your wine cellar to adapt it to your different requirements.

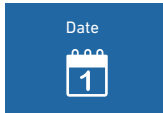

1) Date

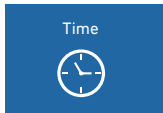

2) Time

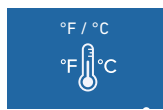

3) Fahrenheit and Celsius



4) Language



5) Sabbath



6) Reset

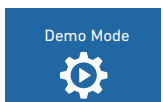

7) Demo Mode

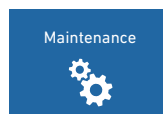

8) Maintenance

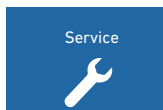

9) Service



10) InfoSystem

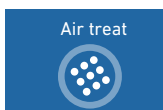

11) Air Treat

1) Date

The display will show the date in the format (day:month:year).

The settings can be modified by touching the display.

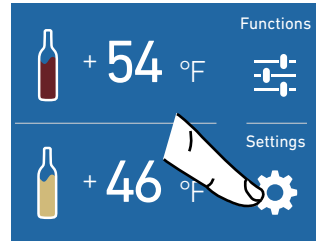

A) Home screen. Touch the **SETTINGS** icon.

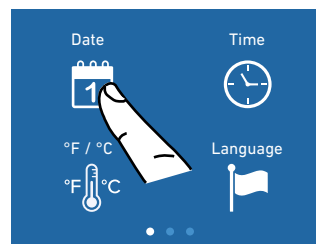

B) Touch the **DATE** icon.

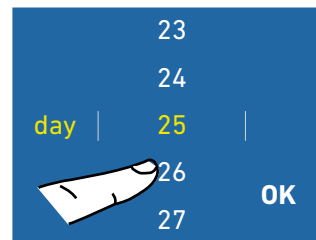

C) Scroll up and down to select the desired day and touch **OK**.

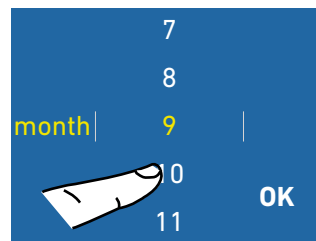

D) Scroll up or down to select the desired month, then touch **OK**.

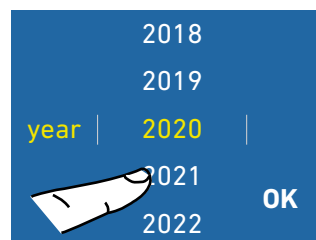

E) Scroll up or down to select the desired year, then touch **OK**.

6. FUNCTIONS AND SETTINGS

2) Time

The display shows the hours and minutes in the format hh:mm. This function allows you to select a 12 or 24 hr. clock mode.

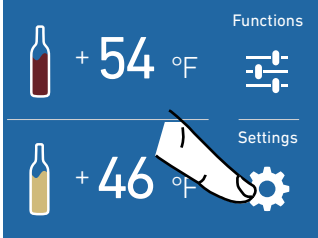

A) Home screen. Touch the **SETTINGS** icon.



B) Touch the **TIME** icon.

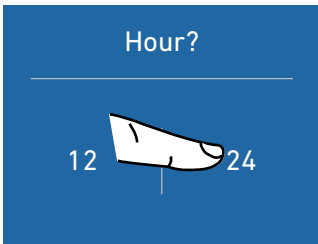

C) Select the mode in which you want to see the time: 12 or 24 hr.

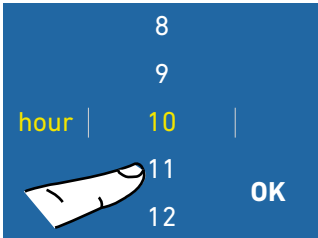

D) Scroll up or down to select the time and then touch **OK**.

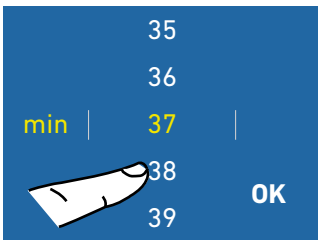

E) Scroll and select the minutes and then touch **OK**.

3) °F/°C

This function allows visualizing the temperature in degrees Fahrenheit (default) or Centigrade.

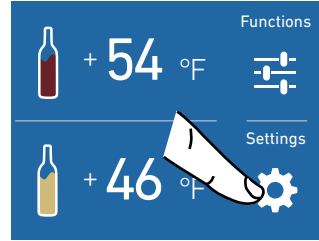

A) Home screen. Touch the **SETTINGS** icon.

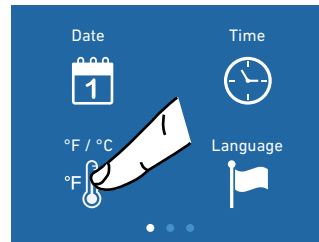

B) Touch the **°F/°C** icon.

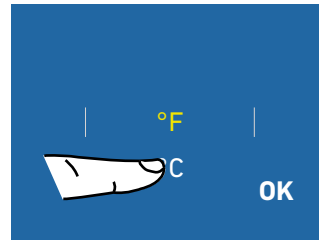

C) Scroll up or down to select the degrees in Centigrades or Fahrenheit and press **OK**.

6. FUNCTIONS AND SETTINGS

4) Language

To set the language of the wine cellar, simply follow the procedure.

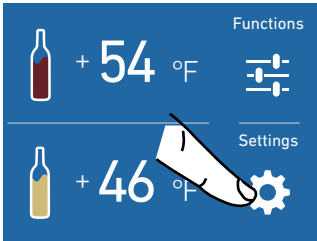

A) Home screen.
Touch the **SETTINGS** icon.

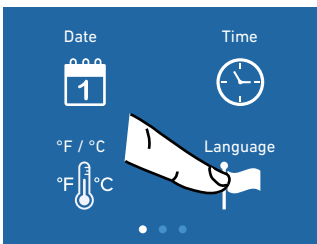

B) Touch the **LANGUAGE** icon.



C) Scroll up or down to select the desired language and press **OK**.

5) Sabbath Mode

The function makes it possible to comply with certain religious observances requiring that the operation of the appliance not be affected by the opening or closing of the doors (the thermostatic control, interior lighting and ice maker are all deactivated).

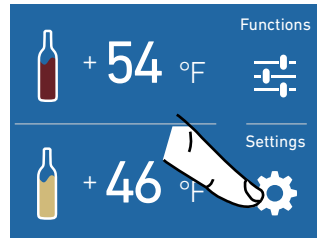

A) Home screen.
Touch the **SETTINGS** icon.

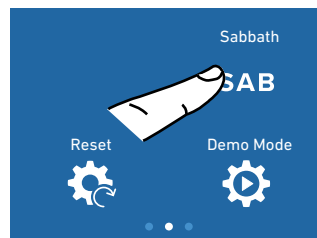

B) Scroll right twice and touch the **SABBATH** icon.

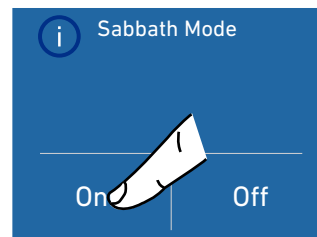

C) Touch the **ON** button to activate the function.

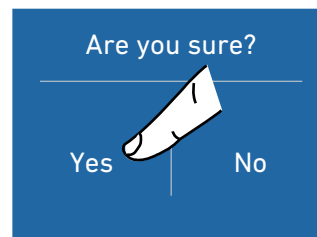

D) Touch the **YES** button to activate the function.



E) The wine cellar will work according to this configuration.

6. FUNCTIONS AND SETTINGS

6) Reset

This offers the possibility to reset default factory settings and cancels any previous changes.

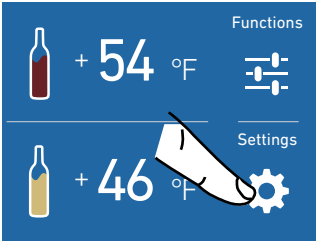

A) Home screen. Touch the **SETTINGS** icon.

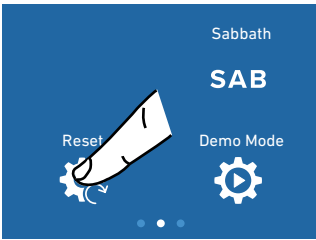

B) Scroll right twice and select the **RESET** icon.

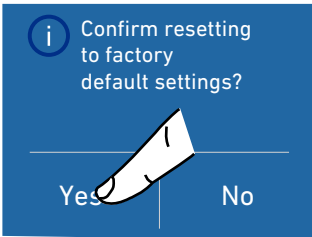

C) Touch the **YES** button to reset.

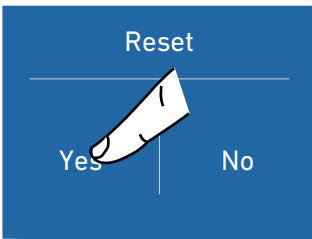

D) Touch the **YES** button.

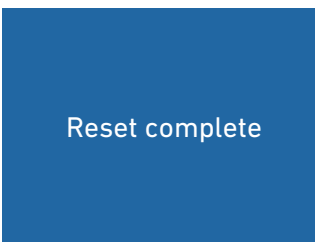

E) The reset has been performed. The appliance factory settings have been restored.

7) Demo Mode

It is possible to simulate the functioning of the wine cellar for showroom display.

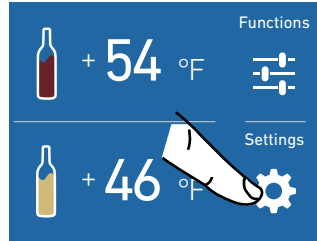

A) Home screen. Touch the **SETTINGS** icon.

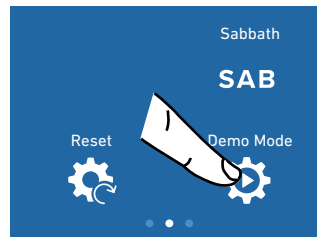

B) Scroll right twice and select the **DEMO** icon.

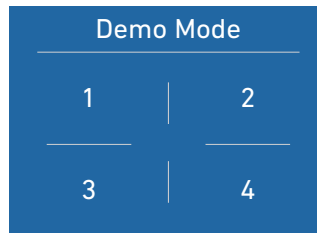

C) Enter the **PASSWORD** necessary to activate, that must be requested from the Manufacturer. Default password: 1-2-3-4

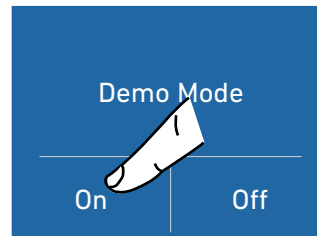

D) Touch the **ON** or the **OFF** button.

6. FUNCTIONS AND SETTINGS

8) Maintenance

In order for the wine cellar to operate correctly, the ventilation grill, filter and condenser must be cleaned periodically. The recurring cleaning every 12 months is reminded by an acoustic and optical signal on the display.

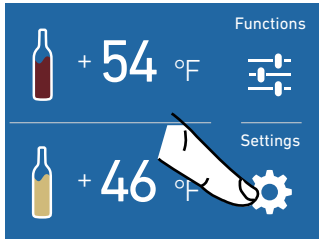

A) Home screen. Touch the **SETTINGS** icon.



B) Scroll right three times to reach this screen and touch the **MAINTENANCE** icon.

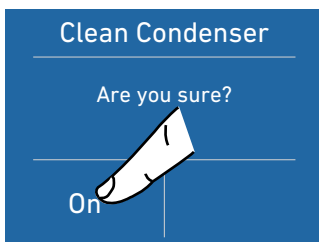

C) When you start the unit the warning is disabled.

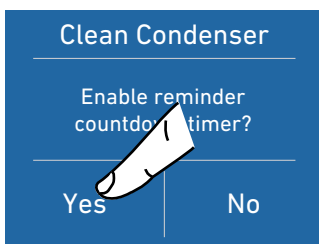

D) To enable the reminder, touch the YES icon.

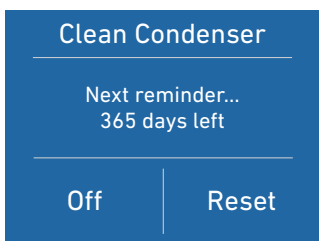

E) The display shows the remaining days before the next cleaning. Touch Home to go back to the main screens.

9) Service

The Service  function is reserved for the Manufacturer's Customer Service.

10) Info System

The Info System function displays the product data, such as the software code, the serial number and the wine cellar factory codes.

11) Disable Maintenance

It is possible to disable the signal and see the time left before the next cleaning that has to be done.

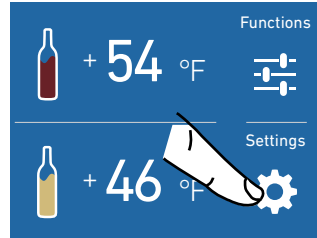

A) At the Home screen, touch the Settings icon.

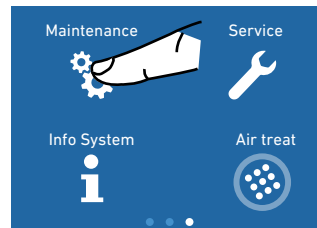

B) Scroll left twice and touch the Maintenance icon..

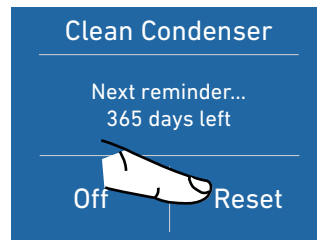

C) Instead, if you want to disable the reminder, touch the Reset icon.

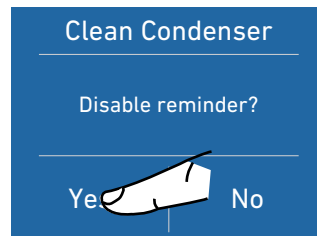

D) To disable the reminder, touch the YES icon.

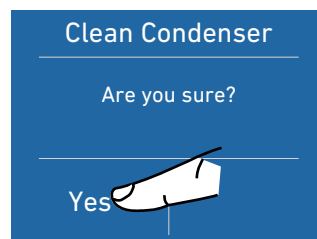

E) When you start the unit, the warning is disabled. Touch Home to go back to the main screens.

12) Air Treat

The activated carbon filter inside the wine cellar helps purify the air within the compartment. These filters reduce the formation of mold and bacteria and contribute to the preservation of the wine.

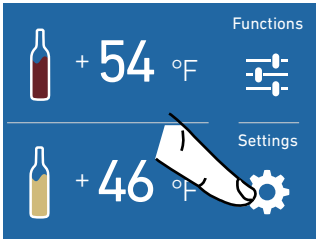

A) At the Home screen, touch the Settings icon.



B) Scroll left twice and touch the Maintenance icon..

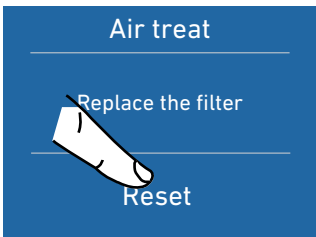

C) touch the Reset icon

D) Replace the filter.

Remove the upper wooden drawer [1]
At the bottom is the filter [2]. Insert the appropriate key, turn, remove the filter and replace it with the new one.

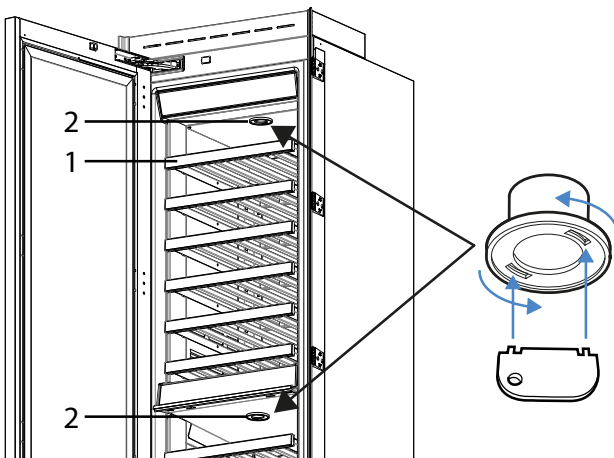

7.1. Internal layout (positioning, adjustment, removal)

Wine shelf

The shelves can be easily removed for cleaning. Remove the bottles, completely extract the shelf, tilt it upward until the wheels are free of their seat and extract it.

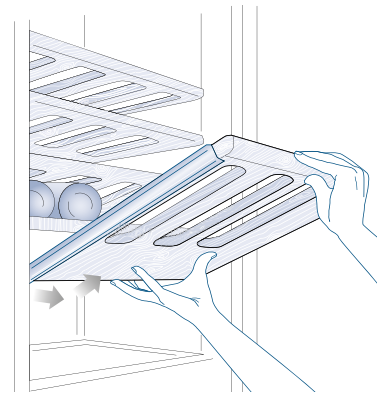

8.1. Lighting

To provide optimum interior lighting, LED strips illuminate the different areas of the Upper compartment. In case of malfunction and/or failures of the lighting system, the repair should be carried out by an authorized Viking technician.



Note

Once activated, the light of the top compartment will automatically shut off after 6 hours.

column wine cellar

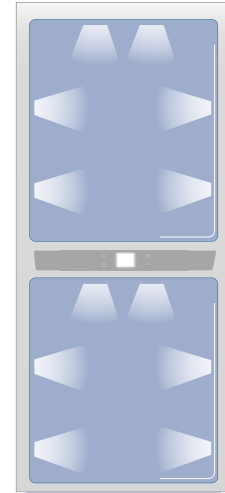

In case of malfunction and/or wearing out of the lighting system, the repair should be performed by a qualified Viking Service technician.

9. CONSERVATION OF WINES

9.1. General directions

As is known, wine can be stored for long periods of time if this is done under the following conditions:

- > Suitable temperature without appreciable variations over time.
- > Controlled level of humidity.
- > Protection from light.
- > Absence of noise and vibrations.
- > Absence of odors.
- > Bottle kept horizontal.

All of these conditions are fully met in your wine cellar.

9.2. Storage temperatures

The space offered by the Lower and Upper compartments, which can be expanded as necessary by using the drawer compartment as a wine cellar, allows conservation of your best wines at 2 different temperatures.

The compartments are initially set to the following temperatures:

> **Upper compartment.**

53 °F (+12°C)
adjustable from 39 °F to 64°F (from +4°C to +18°C)

> **Lower compartment**

50 °F (+10°C)
adjustable from 39 °F to 64°F (from +4°C to +18°C)

All the temperatures can be modified according to the characteristics of the wines and personal preferences. However, you should attempt to keep the temperature as constant as possible over time.

Rapid and large-scale temperature variations can in fact cause dilation of the liquid and early aging of the wine.

You should also avoid very low temperatures (below 4°C - 39°F) which may lead to the formation of deposits and damage the aesthetic qualities of the wine.

All the compartments offer optimal conditions and take into account all these needs.

Models with Upper and Lower (Column)

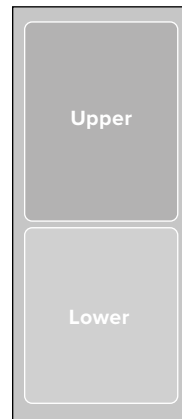

> Upper compartment
53 °F (+12°C)
-adjustable from 39 °F to 64 °F
from (+4°C to +18°C)

> Lower compartment
50 °F (+10°C)
-adjustable from 39 °F to 64 °F
from (+4°C to +18°C)

9. CONSERVATION OF WINES

9.3. Time of conservation

Improvement of wine over time and its duration usually depends on the character of the variety and its type. The following chart shows the best period of conservation and aging for various types in ideal conservation conditions offered by your appliance.

In any case, follow the suggestions offered by the bottle producer, in particular for the finest wines.

TYPE OF WINE	CONSERVATION TEMPERATURE	TIME OF CONSERVATION
New wines (Vin Nouveau)	from 54°F (12°C) to 57°F (14°C)	6 months
Sweet sparkling wines	from 46°F (8°C) to 50°F (10°C)	1 year
Rosé	from 50°F (10°C) to 57°F (14°C)	1 year
Semi-sparkling wines	from 50°F (10°C) to 54°F (12°C)	1-2 years
Normal white wines	from 50°F (10°C) to 57°F (14°C)	1-2 years
Light red wines	from 54°F (12°C) to 57°F (14°C)	2 years
Dry sparkling wines	from 46°F (8°C) to 50°F (10°C)	2 years
Classic sparkling wines	from 46°F (8°C) to 50°F (10°C)	3-4 years
Barrique and Vigorous white wines	from 46°F (8°C) to 54°F (12°C)	3-5 years
Normal red wines	from 57°F (14°C) to 61°F (16°C)	3-5 years
Barrique and Vigorous red wines	from 57°F (14°C) to 64°F (18°C)	7-10 years
Straw wines or Liqueurous wines	from 61°F (16°C) to 61°F (16°C)	10-15 years

9. CONSERVATION OF WINES

9.4. Consumption temperature

As a general rule, white wines should be served at a temperature between 10°C and 12°C (50°F and 54°F) and red wines between 12°C and 14°C (54°F and 57°F).

Some wines may however be best enjoyed at higher or lower temperatures.

You should also keep in mind that, during the summer, wine is generally enjoyed at lower temperatures than during the winter.

You should also consider the following:

White wines

White wines are normally not served at high temperatures, since they are generally more acidic than red wines and not very tannic. Therefore they are more enjoyable at low temperatures. It is preferable to serve these wines between 10°C and 14°C (50°F and 57°F). Young, fresh and aromatic wines can also be served at 10°C (50°F), while less aromatic ones are served at 12°C (54°F). Temperatures between 12°C and 14°C (54°F and 57°F) are for soft, mature white wines that have been aged for some years in the bottle.

Higher temperatures would favour the exaltation of the sweet character of the wine, at the expense of the acidity and flavour, which are considered pleasant and desirable characteristics of this type of wine.

Rosé

Rosé wine is served at the same temperature as white wines. It should be noted that these wines may include a certain amount of tannin and may therefore be preferable at higher temperatures.

Therefore, they are served between 10°C and 12°C (50°F and 53.6 °F), if young and fresh, and between 12°C and 14°C (54°F and 57.2 °F) if robust and mature.

New wines (Vin Nouveau)

Due to the special processing they undergo, new vintage wines contain a low tannin content and are therefore more enjoyable if served between 12°C and 14°C (54°F and 57°F).

Red wines

Since they contain more tannin and are less acidic, red wines are normally served at higher temperatures. Younger wines with less tannin are normally served between 14°C and 16°C (57°F and 61°F), while more full-bodied ones that are more tannic may be served at up to 18°C (64°F). Some wines that have aged for years in the bottle, still full-bodied and tannic, may be served at 18°C (64°F) or even 20°C (68°F).

Young red wines with little tannin and slightly structured may be enjoyable at lower temperatures, between 12°C and 14°C (54°F and 57°F).

Sparkling wines

It is difficult to provide instructions to cover the wide variety of sparkling wines in available. As a general rule, sweeter and more aromatic sparkling wines should be served at lower temperatures, down to 8°C (46°F), whereas more tannic sparkling wines may be served at higher temperatures, up to 14°C (57°F).

Dry sparkling wines are usually served between 8°C and 10°C (46°F and 50°F). "Classic" sparkling wines are normally served at these temperatures, which may be as high as 12°C (54°F) for sparkling wines that have been aged for some time.

It is however advisable, especially for finer wines, to follow the suggestions and recommendations of the winemaker on the bottle.

Liqueur and straw wines

These types of wines can be served at temperatures between 16°C and 18°C (61°F and 64°F), depending on personal tastes, to attenuate the sweet taste of straw wines, it can also be served at 10°C (50°F).

9.5. Positioning the bottles



The sliding shelves are made of fine wood and contoured so as to hold bottles of the most classical traditional shape or of the most modern design.

Whether your collection holds fine bouteilles or petit bouteilles, they will be right at home in the Viking Wine Cellar.



Warning

After a prolonged interruption of electrical power, once the electrical power is reactivated, an audible signal will indicate if the temperature has raised above normal levels. In addition to this the display will show for one minute the highest temperature detected inside the compartments, to allow the user to decide how to better use the food items.

After one minute the display will resume normal operation, while the **ALARM**  button will continue to blink; touching the **ALARM**  button it will be possible to display the highest recorded temperatures.

Burgundy
BOTTLE



Bordeaux
BOTTLE



10.1. Care and Cleaning

To clean parts and surfaces made of steel, use a microfiber cloth and the sponge provided in the kit supplied with the appliance.

Always use the cloth and sponge in the direction of the steel's satin finish.

Every now and then, to polish the steel, wipe with a slightly damp microfibre cloth.

Do not use the sponge on aluminium parts, such as the handles and the edging on the glass shelves. Take special care to keep the ventilation openings in the appliance or in the cabinet that houses it free of obstructions.



Note

Scrupulously follow the detailed instructions that can be found in the kit provided and never use abrasive or metallic products which could scratch and permanently damage the satin finishing on the appliance. Before performing any sort of cleaning, disconnect the appliance from the electrical power supply.

Make sure you do not damage the refrigerant circuit in any way.



Warning!

The use of chlorine-based cleaning products or other products that contain chlorine should be avoided (bleach, hypochlorite, etc.).

10. CARE AND CLEANING

10.2. Internal cleaning

Clean the interior of the appliance and its removable parts by cleaning them with a solution of lukewarm water mixed with a small amount of dishwashing detergent.

Rinse and dry right away.

Do not use mechanical devices or other methods to speed up defrosting.



Warning!

The use of chlorine-based cleaning products or other products that contain chlorine should be avoided (bleach, hypochlorite, etc.).



Warning!

Do not use water on the electrical parts, lights or control panel.



Do not bring cold glass parts into contact with hot water.

Do not wash any parts of the refrigerator in a dishwashing machine since this could damage or irreparably deform the parts.

10.3. Cleaning of the ventilation grill, filter and condenser

In order for the unit to operate correctly, the ventilation grill, filter and condenser must be cleaned periodically.

A reminder for this periodic cleaning, to be performed every 6 months, is provided through sound alerts and a notification shown on the display. To activate or deactivate this warning signal and display the time left to the next cleaning, see chap. “6.1. Functions“ on page 17).

The condenser is located behind the lower front ventilation grille.

To clean it use a vacuum cleaner with a soft brush attachment at maximum power, sweeping it along the vent slits.

In the event of significant dust build up, the ventilation grill can be removed to allow a more thorough cleaning of the filter.

After cleaning the condenser, touch the **RESET** icon in order to reactivate the warning signal in 6 months.

If you do not want the warning cleaning signal of the condenser any more, touch the **OFF** icon (see chap. “8) Maintenance“ on page 22).

10.4. Lower condenser

To clean the condenser follow the instructions:

- > Switch off the wine cellar by pressing the **ON/OFF** button  on the main control panel for approx 3 seconds.
- > Wait approx. 30 minutes, until the condenser cools down to ambient temperature.
- > Remove the removable grille under the door.

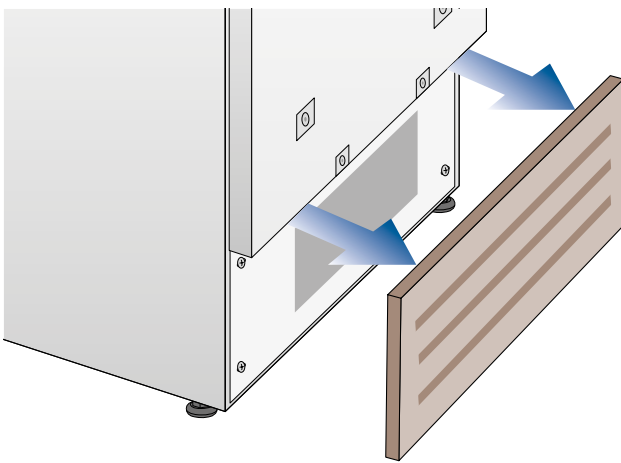

- > Clean the condenser thoroughly from all dust deposits as shown in the figure, taking care not to damage it.

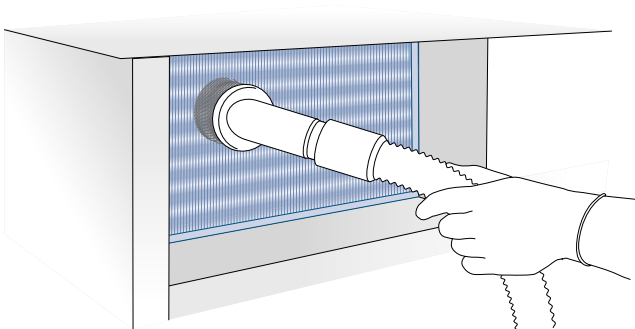

- > Restart the appliance acting on the **ON/OFF**  button again for about 3 seconds.



Warning!

The edges of the condenser are sharp, therefore use suitable protection for your hands and arms when cleaning the condenser.

11. TROUBLESHOOTING

11.1. Troubleshooting Guide

If you notice any malfunctioning of your appliance, use this guide before calling for service. This guide can help you to solve the problem on your own or could provide important information that you can convey to the Service technician in order to ensure rapid and effective repair.

“Call Service” message

A malfunction is usually indicated by a message on the display.

Problems that cannot be resolved by the user are signalled through a malfunction code and the “Call Service” message.

The appliance does not work

Is the appliance connected to the electrical power supply?

Is electrical power being supplied from the electrical socket?

Is the **ON/OFF**  key activated?

Is the condenser clean? See page 29

The internal temperatures are higher than normal

Does the display show a malfunction code? See page 31.

Is the temperature adjusted correctly?

Is the condenser clean? See page 29

Was the door open for a long period of time?

Were large quantities of food recently placed inside?

The appliance keeps running for a long time

Bear in mind that during very hot weather and with very high temperatures in the room it is normal for the compressor to remain on for extended periods of time.

Was the door open for a long period of time?

Were large quantities of food recently placed inside?

Is the condenser clean? See page 29

Check that the doors are closed and that food or containers are not keeping the door from fully closing.

If you hear unusual noises

It is normal to hear noise from the fans or compressors during the defrost phase. Noise could be more marked depending on the position of the appliance and the surrounding environment.

Condensation forms both inside and out

If the atmospheric conditions are very humid or damp, the formation of condensation is normal. Opening the door or drawers for extended periods of time can contribute to the formation of condensation.

In any case, make sure that the doors are always fully closed.

The compartment has frost or ice

Did you leave the doors open for a long period of time?

Be sure to check that the placement of the products inside does not prevent the door from closing.

Are the doors closing completely?

If the doors do not fully close, contact your installer.

In the event of frost or ice build-up due to frequent and extended opening of the doors, deactivate for some time the functions acting on the relative button on the control panel. Wait until the frost or ice melt, then remove the drawer and dry the sides and bottom of the compartment.

Unpleasant odors inside the refrigerator



Clean the appliance thoroughly according to the instructions.



Hermetically cover all of the food. Do not store food for extended periods of time.

The doors are difficult to open

The appliance was designed to permit hermetic closure. When the door is closed, a vacuum condition can be created: in such an event, it is necessary to wait a few seconds until the pressure balances before opening the door.

11.2. Malfunction messages appearing on the display

- > In the event of a malfunction, touch the **ALARM**  button and the display will show the fault message with its error code (see following table).
- > The message will be shown for 3 seconds, then it will go back to the **HOME** screen.
- > To block the message on the screen, press the **INFO** button  on the display. The message will remain on the screen for 30 seconds, then it will go back to the **HOME** screen.
- > In the event that there is more than one error message, the display will show the different fault messages in chronological order.

Display message	Malfunction description
Power Failure	Extended interruption of electrical power The appliance starts up again automatically and indicates the highest recorded temperatures. Press the ALARM  button to deactivate the sound alarm
Door open	Door open This message appears when the door has been open for a few minutes.
Lower too warm	Lower compartment too warm See chap. "11. TROUBLESHOOTING" on page 30
Lower too cold	Lower compartment too cold wait for 12 hours: if the malfunction persists, call Customer Service for advice.
Upper too warm	Upper compartment too warm See chap. "11. TROUBLESHOOTING" on page 30
Upper too cold	Upper compartment too warm wait for 12 hours: if the malfunction persists, call Customer Service for advice.
Error Code...	Functional problems Contact Technical Service.
Check condenser	Check Condenser Every 6 months the display shows the message " CHECK COND. ", clean the condenser and press and hold the ENTER button  for 5 seconds to reset.
Replace filter	Replace water filter cartridge message appears: every 12 months after the reset

Viking Range, LLC
111 Front Street
Greenwood, Mississippi 38930 USA (662) 455-1200

For product information, call 1-888-(845-4641)
or visit the our web site at vikingrange.com