

SAMSUNG

Product Guide

6.3 cu. ft. Smart Freestanding Electric Range with Flex Duo™, No-Preheat Air Fry & Griddle

NE63A6751

Available in:

Fingerprint Resistant Stainless Steel

Fingerprint Resistant Black Stainless Steel



Table of Contents

NE63A6751 - 6.3 cu. ft. Smart Freestanding Electric Range with Flex Duo™, No-Preheat Air Fry & Griddle

Product Overview

Product Overview	4
Carousel Image Order	5

Product Messaging

Features and Benefits	7
Lifestyle Images	12
Fact Tag Guidance	13

Product Specs

Related Products	15
Spec Sheet	16
User Manual and Warranty Information	17

Feature Icons

19

Product Overview

**NE63A6751 – 6.3 cu. ft. Smart Freestanding Electric Range
with Flex Duo™, No-Preheat Air Fry & Griddle**

Product Overview

Product Title

6.3 cu. ft. Smart Freestanding Electric Range with Flex Duo™, No-Preheat Air Fry & Griddle

Product Short Description (99 characters)

Cook two dishes at different temperatures with Samsung's new Flex Duo™ Freestanding Electric Range.

Product Long Description (261 characters)

Cook two dishes at different temperatures with Samsung's new Flex Duo™ Freestanding Electric Range. Use the full oven for a large roast or split it into two smaller ovens that can cook at different temperatures. Upgraded technology makes cooking simple and fun.

Available Colors



**Fingerprint Resistant
Stainless Steel**
NE63A6751SS



**Fingerprint Resistant
Black Stainless Steel**
NE63A6751SG



Carousel Image Order

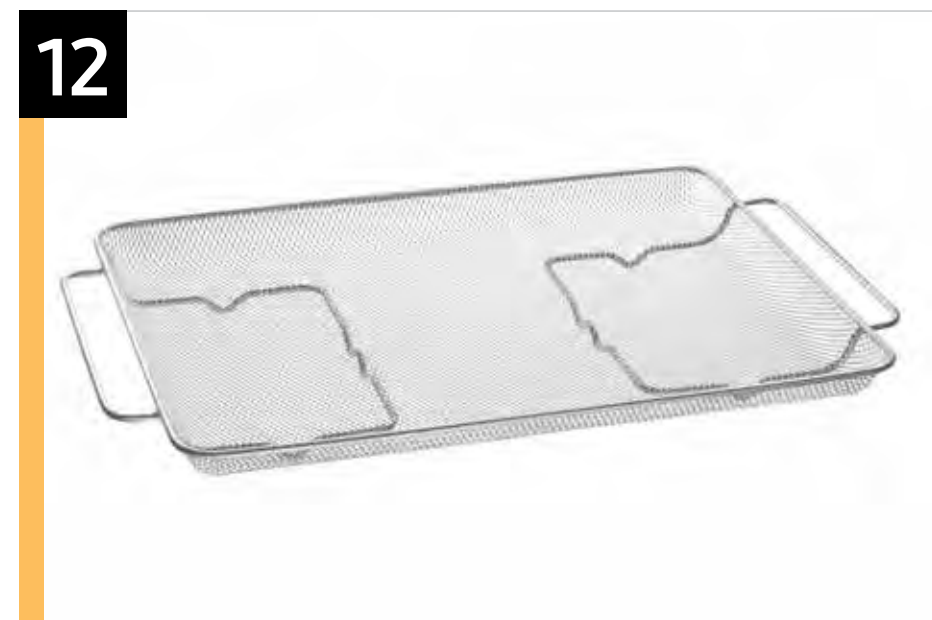



Easy Ad Links: NE63A6751SS
R.COM <https://dam.gettyimages.com/p/z0c3461/external?o=AND&q=NE63A6751SS%20RCOM>
S.COM <https://dam.gettyimages.com/p/z0c3461/external?o=AND&q=NE63A6751SS%20SCOM>
360 Spin <https://dam.gettyimages.com/p/z0c3461/external?o=AND&q=NE63A6751SS%20360%20Spins>

Easy Ad Links: NE63A6751SG
R.COM <https://dam.gettyimages.com/p/z0c3461/external?o=AND&q=NE63A6751SG%20RCOM>
S.COM <https://dam.gettyimages.com/p/z0c3461/external?o=AND&q=NE63A6751SG%20SCOM>
360 Spin <https://dam.gettyimages.com/p/z0c3461/external?o=AND&q=NE63A6751SG%20360%20Spins>



Product Messaging

**NE63A6751 – 6.3 cu. ft. Smart Freestanding Electric Range
with Flex Duo™, No-Preheat Air Fry & Griddle**



Features and Benefits – NE63A6751

Overall Product Headline	Feature Name	Long Body Copy	Short Body Copy	Associated Image
<p>Elevated design</p>	<p>Stainless Steel Design</p>	<p>Our Stainless Steel design elegantly wraps around the cooktop sides and up through the slim control panel, elevating the look of any kitchen. Ergonomic knobs are easy to grip comfortably for precise temperature control. If that’s not enough, tinted glass on the oven door gives your range the upgrade you deserve.</p>	<p>Our Stainless Steel design elegantly wraps around the cooktop sides and up through the slim control panel, elevating the look of any kitchen.</p>	
<p>Make cooking simple with smart technology</p>	<p>Wi-Fi and Voice Enabled</p>	<p>Preheat, adjust time and temperature of your oven, and monitor your cooktop from wherever you are with your smartphone.* Conveniently use voice to control your oven, whether it’s Amazon Alexa, Bixby or Google.**</p> <p><small>*Available on Android and iOS devices. A Wi-Fi connection and a Samsung account are required. **Bixby is Samsung’s brand of artificial intelligence (AI)/Internet of Things (IoT) voice assistant. All voice commands are available on Android and iOS.</small></p>	<p>Preheat, monitor and adjust time and temperature of your oven from wherever you are using your smartphone.*</p> <p><small>*Available on Android or iOS devices. A Wi-Fi connection and a Samsung account are required.</small></p>	
<p>Two ovens or one. You choose.</p>	<p>Flex Duo™</p>	<p>Use the full oven for a large roast or split it into two smaller ovens that can cook at different temperatures, saving both time and energy.</p>	<p>Use the full oven for a large roast or split it into two smaller ovens that can cook at different temperatures.</p>	



Features and Benefits – NE63A6751

Overall Product Headline	Feature Name	Long Body Copy	Short Body Copy	Associated Image
<p>No-Preheat Air Fry – Healthier cooking with a crunch*</p> <p><small>*As compared to deep-frying.</small></p>	<p>Air Fry with Tray</p>	<p>Cooking with a crunch just got healthier with Air Fry.* Using little to no oil, you can quickly prepare your favorite fried foods right in your oven. No preheating required. Air Fry tray included.</p> <p><small>*As compared to deep-frying.</small></p>	<p>A healthier way to prepare your favorite fried foods right in your oven with little to no oil.* No preheating required. Air Fry tray included.</p> <p><small>*As compared to deep-frying.</small></p>	
<p>Grill breakfast, lunch and dinner</p>	<p>Removable Nonstick Griddle</p>	<p>A removable nonstick griddle is included with your cooktop that's perfectly sized to fit the griddle burners. Grill your family's favorite foods and when done, conveniently store the griddle in the range storage drawer.</p>	<p>Grill your family's favorite foods with the included griddle that's perfectly sized to fit the griddle burners.</p>	
<p>Save time with Convection+</p>	<p>Convection+</p>	<p>Powerful Convection+ saves you time by cooking food fast and more evenly. Fan with a heated element circulates hot air in the oven for perfect baking and roasting.</p>	<p>Powerful Convection+ saves you time by cooking food fast and more evenly.</p>	

Features and Benefits – NE63A6751 (Continued)

Overall Product Headline	Feature Name	Long Body Copy	Short Body Copy	Associated Image
<p>Cook enough for the whole crew</p>	<p>Large Oven Capacity</p>	<p>This large 6.3 cu. ft. oven can fit multiple dishes at one time and can easily accommodate big casserole dishes and large roasting pans.</p>	<p>This large 6.3 cu. ft. oven can fit multiple dishes at one time.</p>	
<p>All shine</p>	<p>Fingerprint Resistant Finish</p>	<p>Fingerprint resistant for an everyday beautiful finish.</p>	<p>Fingerprint resistant, beautiful finish.</p>	 <p>Fingerprint resistant</p> <p>Note: Image should be customized by finish color for the respective model.</p>
<p>A cooktop that gets it all done!</p>	<p>Flexible 5-Burner Cooktop</p>	<p>The 5-burner cooktop includes a griddle burner as well as adjustable dual-ring and triple-ring burners so you can cook with the griddle included and a variety of pot and pan sizes. This range is perfect when you have larger meals to prepare.</p>	<p>The 5-burner cooktop includes a griddle burner as well as adjustable dual-ring and triple-ring burners so you can cook with the griddle included and multiple pot and pan sizes.</p>	 <p>Note: GIF and static assets available (GIF is preferred).</p>

Features and Benefits – NE63A6751 (Continued)

Overall Product Headline	Feature Name	Long Body Copy	Short Body Copy	Associated Image
<p>Cooking simplified with easy preset buttons</p>	<p>Bread Proof, Dehydrate, Keep Warm and Favorite Cook Settings</p>	<p>Prepare a variety of foods with the aid of easy preset buttons. With a simple push of a button, you can proof bread, dehydrate your favorite jerky and keep meals warm in the oven with precision. And if you have a favorite recipe, conveniently save the settings in the Samsung SmartThings mobile app and send them to your oven.*</p> <p><small>*Available on Android and iOS devices. A Wi-Fi connection and a Samsung account are required.</small></p>	<p>Prepare foods with the aid of easy preset buttons. Four preset buttons include: Bread Proof, Dehydrate, Keep Warm and Favorite Cook.</p>	
<p>Spend less time cleaning</p>	<p>Self Clean & Steam Clean</p>	<p>Keep your oven spotless with Self Clean and Steam Clean. Self Clean deep cleans by heating to a high temperature to burn off grease and food residue. For easier cleanup in 20 minutes, use Steam Clean.</p>	<p>Keep your oven spotless with the Self Clean and Steam Clean.</p>	 <p style="text-align: center;">Self Clean Steam Clean</p>
<p>Extra space for your cookware</p>	<p>Storage Drawer</p>	<p>The Storage Drawer provides extra space to keep bakeware or oven accessories. Simply grab a bowl within easy reach to serve food in.</p>	<p>The Storage Drawer provides extra space to keep bakeware or oven accessories.</p>	

Lifestyle Images

**NE63A6751 – 6.3 cu. ft. Smart Freestanding Electric Range
with Flex Duo™, No-Preheat Air Fry & Griddle**

Lifestyle Images

Easy Ads link

<https://dam.gettyimages.com/p/z0c3461/external?o=AND&q=NE63A6751%20Lifestyle>



Fact Tag Guidance

Please follow one of the below naming conventions for fact tags at retail, accounting for any potential character count limitations. Please also ensure that any feature list appearing on fact tags follows the Product Messaging hierarchy and the copy noted in the Product Guide for each model.

NE63A6751

Long (More than 40 Characters)

6.3 cu. ft. Smart Freestanding Electric Range with Flex Duo™, No-Preheat Air Fry & Griddle (90 characters)

Medium (40 Characters or Less)

6.3 cu. ft. Flex Duo™ Freestanding Range (40 characters)

Short (30 Characters or Less)

6.3 cu. ft. Freestanding Range (30 characters)



Product Specs

**NE63A6751 – 6.3 cu. ft. Smart Freestanding Electric Range
with Flex Duo™, No-Preheat Air Fry & Griddle**

Related Products

COLOR	PRODUCT	MODEL
-------	---------	-------

Black Stainless Steel	OTR	ME21M706BAG
	OTR	ME21R7051SG
	DISH	DW80R7061UG
	REF	RF28R7351SG

Stainless Steel	OTR	ME21M706BAS
	OTR	ME21R7051SS
	DISH	DW80R7061US
	REF	RF28R7351SR

Spec Sheet

Easy Ads link

<https://dam.gettyimages.com/p/z0c3461/external?o=AND&q=NE63A6751SS%20Spec%20Sheet>

NE63A6751SS

Samsung Smart Freestanding Electric Range with Flex Duo™, No Preheat Air Fry & Griddle
6.3 cu. ft. Capacity



Signature Features

Flex Duo™

- Use the full oven for a large roast or split it into two smaller ovens that can cook at different temperatures, saving both time and energy.

Air Fry

- A healthier way to prepare your favorite fried foods right in your oven with little to no oil.* No preheating required. Air Fry tray included.
*As compared to deep frying.

Removable Nonstick Griddle

- Grill your family's favorite foods with the included griddle that is perfectly sized to fit the griddle burners.

SAMSUNG

Available Colors

- Fingerprint Resistant Stainless Steel (shown)
- Fingerprint Resistant Black Stainless Steel



Flex Duo™



Air Fry

Features

- Flex Duo™
- Air Fry, Tray Included
- Removable Nonstick Griddle
- Convection*
- Large Oven Capacity – 6.3 cu. ft.
- Fingerprint Resistant Finish
- Extra Oven Settings - Bread Proof, Dehydrate, Favorite Cook, Keep Warm
- Storage Drawer

Convenience

- Wi-Fi Connectivity
- Voice-Enabled
- SmartThings Cooking
- Convection Auto Conversion
- Self & Steam Clean
- Hidden Bake Element
- Sabbath Mode
- Child Safety Lock
- Delay Start
- Auto Oven Light
- Kitchen Timer







NE63A6751SS

Samsung Smart Freestanding Electric Range with Flex Duo™, No Preheat Air Fry & Griddle
6.3 cu. ft. Capacity

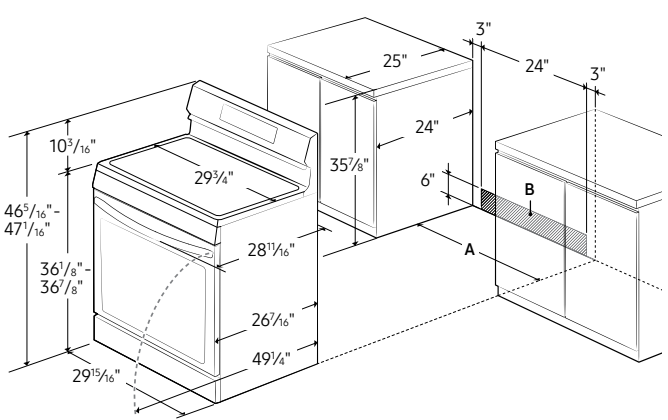
Installation Specifications



A: Cabinet opening min 30"
B: Acceptable electrical outlet area

IMPORTANT: If your cabinets are over 36 1/4" high, you must install this range on a hard, heat-resistant support that raises the surface of the range so that it is about even with the countertop.

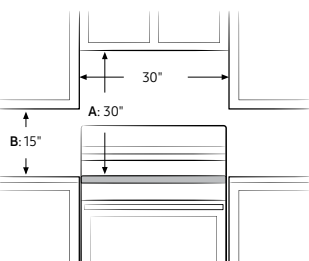

A: 30" minimum clearance between the top of the cooking surface and the bottom of an unprotected wood or metal cabinet; or 24" minimum when the bottom of the wood or metal cabinet is protected by not less than 1/2" of flame-retardant millboard covered with not less than no. 28 MSG sheet steel, 0.015" stainless steel, 0.024" aluminum, or 0.020" copper.
B: 15" minimum between the countertop and the adjacent cabinet bottom.

IMPORTANT: Consult with Installation Manual for detailed instructions before installing. All ranges must be installed with the Anti-Tip device that is included.

SAMSUNG

Power Source
240 V/208 V/60 Hz/40 A

Electric Ceramic Cooktop

- Right Front: 6"/9"/12" Triple Ring Burner, 3000 W
- Left Front: Griddle Burner, 1800 W
- Right Rear: 6", 1200 W
- Left Rear: Griddle Burner, 1800 W
- Center: Warming Center, 100 W

Oven

- Upper Capacity: 3.4 cu. ft.
- Lower Capacity: 2.7 cu. ft.
- Convection Element/Heater
- Convection Bake
- Convection Roast
- Bake
- Variable Broil: Low/High
- Air Fry
- Bread Proof
- Dehydrate

Warranty
One (1) Year Parts and Labor

Product Dimensions & Weight (WxHxD)
Oven Interior Dimensions:
24 13/16" x 22 7/16" x 19 3/4"
Outside Net Dimensions:
29 15/16" x 46 5/16" - 47 1/16" (Adjustable) x 28 11/16"
Weight: 192 lbs

Shipping Dimensions & Weight (WxHxD)
Dimensions:
33 1/16" x 50 3/16" x 30 5/16"
Weight: 215 lbs

Color	Model #	UPC Code
Fingerprint Resistant Stainless Steel	NE63A6751SS	887276552101
Fingerprint Resistant Black Stainless Steel	NE63A6751SG	887276552088



Actual color may vary. Design, specifications, and color availability are subject to change without notice. Non-metric weights and measurements are approximate.
©2021 Samsung Electronics America, Inc. 85 Challenger Road, Ridgefield Park, NJ 07060. Tel: 800-SAMSUNG. samsung.com. Samsung is a registered trademark of Samsung Electronics Co. Ltd.

Spec Sheet - front

Spec Sheet - back

User Manual and Warranty Information

Easy Ads link

<https://dam.gettyimages.com/p/z0c3461/external?o=AND&q=NE63A6751%20User%20manual>

<https://dam.gettyimages.com/p/z0c3461/external?o=AND&q=NE63A6751%20Warranty>



Electric Range

User manual

NE63*675*S*

User Manual

Warranty (U.S.A)

SAMSUNG ELECTRIC RANGE

LIMITED WARRANTY TO ORIGINAL PURCHASER WITH PROOF OF PURCHASE
This SAMSUNG brand product, as supplied and distributed by SAMSUNG ELECTRONICS AMERICA, INC. (SAMSUNG) and delivered new, in the original carton to the original consumer purchaser, is warranted by SAMSUNG against manufacturing defects in materials or workmanship for the limited warranty period, starting from the date of original purchase, of:

One (1) Year Parts and Labor

This limited warranty is valid only on products purchased and used in the United States that have been installed, operated, and maintained according to the instructions attached to or furnished with the product. To receive warranty service, the purchaser must contact SAMSUNG at the address or phone number provided below for problem determination and service procedures. Warranty service can only be performed by a SAMSUNG authorized service center. The original dated bill of sale must be presented upon request as proof of purchase to SAMSUNG or SAMSUNG's authorized service center to receive warranty service. SAMSUNG will provide in-home service within the contiguous United States during the warranty period at no charge, subject to availability of SAMSUNG authorized servicers within the customer's geographic area. If in-home service is not available, SAMSUNG may elect, at its option, to provide transportation of the product to and from an authorized service center. If the product is located in an area where service by a SAMSUNG authorized servicer is not available, you may be responsible for a trip charge or required to bring the product to a SAMSUNG authorized service center for service.

To receive in-home service, product must be unobstructed and accessible to the service agent.

During the applicable warranty period, a product will be repaired, replaced, or the purchase price refunded, at the sole option of SAMSUNG. SAMSUNG may use new or reconditioned parts in repairing a product, or replace the product with a new or reconditioned product. Replacement parts and products are warranted for the remaining portion of the original product's warranty or ninety (90) days, whichever is longer. All replaced parts and products are the property of SAMSUNG and you must return them to SAMSUNG.

This limited warranty covers manufacturing defects in materials or workmanship encountered in normal household, noncommercial use of this product and shall not cover the following: damage that occurs in shipment, delivery, installation, and uses for which this product was not intended; damage caused by unauthorized modification or alteration of the product; product where the original factory serial numbers have been removed, defaced, changed in any way, or cannot be readily determined; cosmetic damage including scratches, dents, chips, and other damage to the product's finishes; damage caused by abuse, misuse, pest infestations, accident, fire, floods, or other acts of nature or God; damage caused by use of equipment, utilities, services, parts, supplies, accessories, applications,

Warranty

Feature Icons

**NE63A6751 – 6.3 cu. ft. Smart Freestanding Electric Range
with Flex Duo™, No-Preheat Air Fry & Griddle**

Feature Icons

Easy Ads link

<https://dam.gettyimages.com/p/z0c3461/external?o=AND&q=NE63A6751%20Icons>

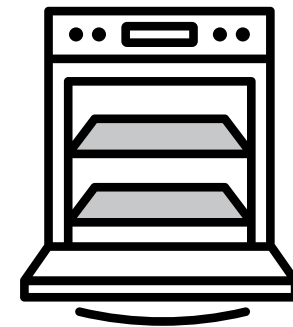

Flex Duo™

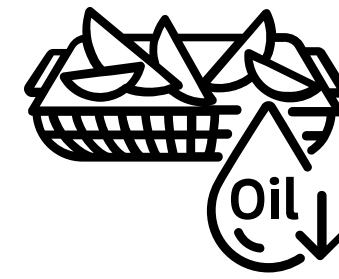

Air Fry

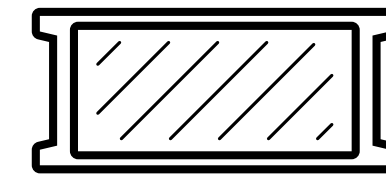

Removable
Nonstick Griddle

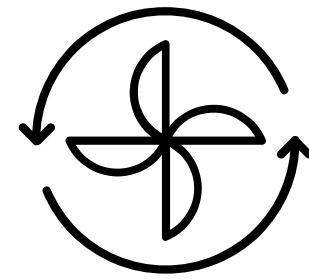

Convection+

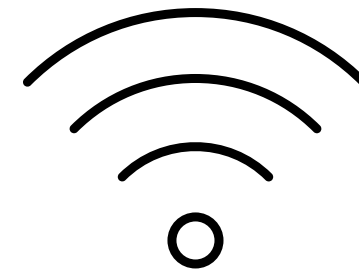

Wi-Fi Connectivity



Fingerprint
Resistant Finish

SAMSUNG