

Congratulations on your purchase of a high-quality Insignia product. Your NS-R2001 represents the state of the art in stereo receiver design and is designed for reliable and trouble-free performance.

Package contents

- Receiver
- Remote control
- AAA batteries (2)
- AM and FM antennas
- User Guide
- Quick Setup Guide

Before using your new product, please read these instructions to prevent any damage.

Installing the remote control batteries

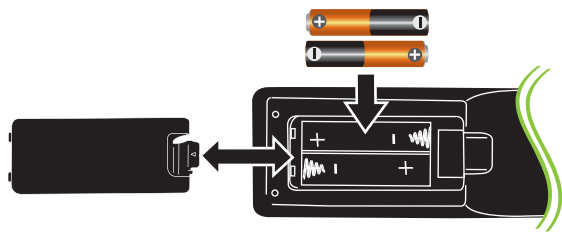

Setting up your receiver

1 Find a location for your receiver

- Install your receiver on a stable flat surface.
- Position your receiver so that it has a direct line of sight to the remote control.
- Do not expose your receiver to extremes of temperature or humidity.
- Avoid placing your receiver on a hot surface such as on top of other hot running equipment. Make sure that there is adequate ventilation to your receiver.

2 Connect devices

Connecting the antennas

- 1 Connect the indoor FM antenna to the FM jack on the back of the receiver.
- 2 Move the position of the antenna until you get the best reception of your favorite FM stations.
- 3 Remove the AM antenna from its package (if necessary), uncoil the wire, then fold the two halves of the loop together.
- 4 Fold the base under the loop and press it onto the pins on the bottom of the loop.
- 5 To connect the indoor AM antenna, press the GND and AM Loop levers, insert the ends of the wires, then release the levers. Make sure only the bare, stripped wire is inserted in the jack.
- 6 Move the position of the antenna until you get the best reception of your favorite AM stations.

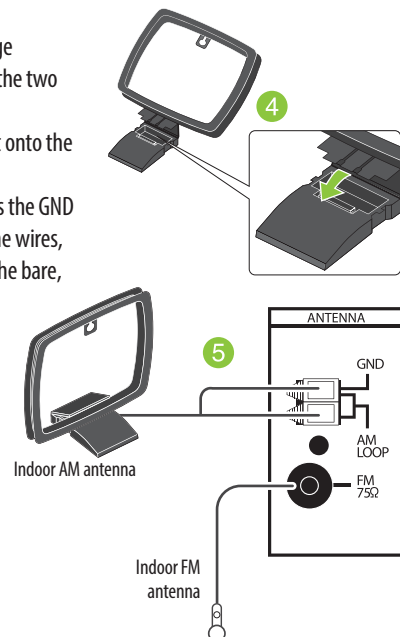

Connecting audio-only devices

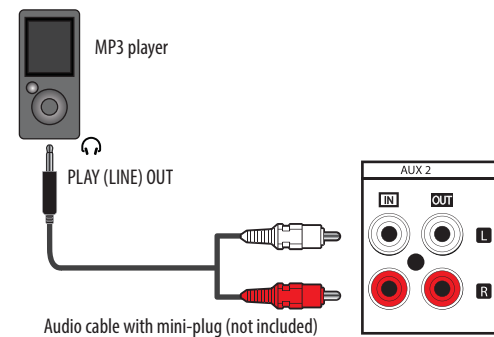
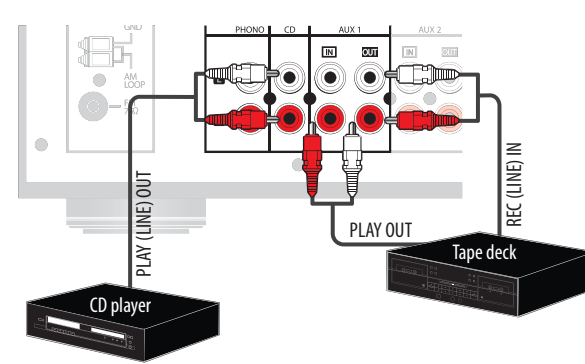

Connecting devices with video

- 1 Connect the cable from the **Audio Out** jack on the audio device to the L/R audio jacks on the receiver.
- 2 Connect the video cable(s) (component, composite, HDMI, DVI, S-Video, or RF) from the output jack on the video device to the appropriate input jack on your TV.

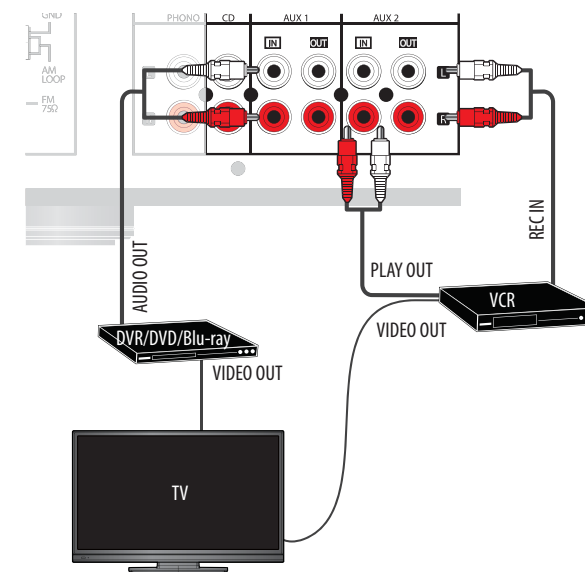

Connecting a turntable

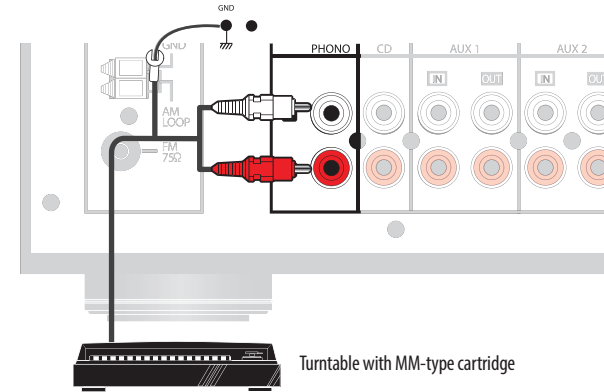

Connecting speakers

NOTES:

- If you have only one pair of speakers, connect them to the **SPEAKER A** terminals.
- 1 Turn the terminal cap to loosen it.
 - 2 Insert the bare wire into the terminal fully and tighten the terminal cap to securely connect it. Make sure that you strip the wire adequately so that none of the wire insulation is under the terminal.
 - 3 Make sure it is fastened firmly by pulling the cable lightly.
- Be sure to connect the speakers correctly according to the channel (left and right) and the polarity (+ and -). If you do not make the connections correctly, you will not hear any sounds from the speakers. If the sound is unnatural and lacks bass, the speaker polarity is incorrect.

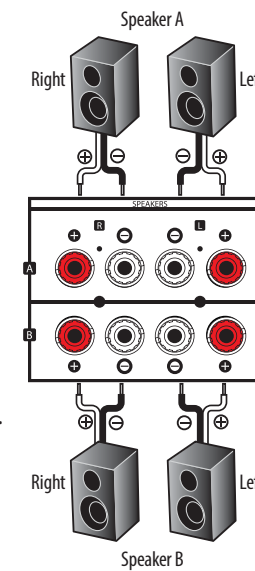

Connecting headphones

- 1 Insert a 1/4" headphone plug into the headphone jack on the front of the receiver.



- 2 Press the **SPEAKER A** or **SPEAKER B** button on the remote or the receiver to turn the speakers off. The corresponding speaker indicator turns off, **H** appears on the display, and sound can be heard from the headphones.

3 Connect the power

- Plug the power cord into an AC outlet.

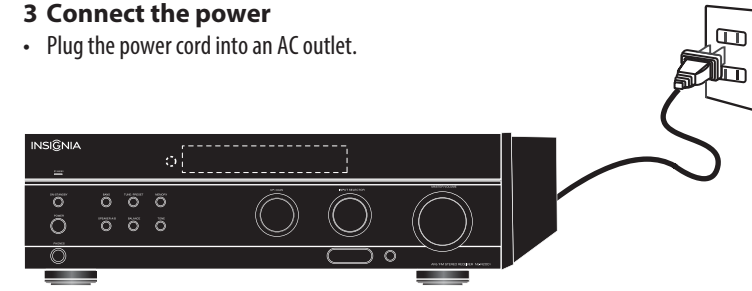

Using your receiver

- 1 Press **POWER** on the receiver. The **STANDBY** indicator lights blue.
- 2 Press **POWER ON** on the remote control or the **ON/STANDBY** button on the receiver to turn the receiver on. The **STANDBY** indicator turns off.

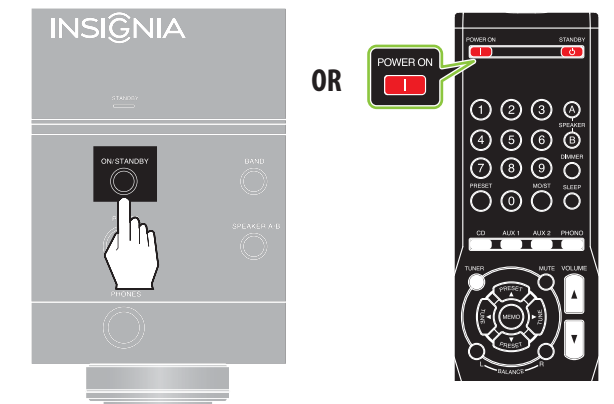

- 3 Turn on devices connected to the receiver.
 - 4 If you connected a video device, such as a DVD or Blu-ray player:
 - Select that device's input on the TV.
 - Turn your TV speakers off if you only want the audio to come from your receiver.
 - 5 Rotate the **INPUT SELECTOR** knob or press the desired input selector button on the remote to select the input source.
 - 6 Press **SPEAKER A** or **SPEAKER B** on the remote to turn the corresponding speakers on. **SPK A**, **SPK B**, **SPK AB**, or **SPK OFF** appears on the display and sound can be heard from the speakers.
 - 7 Turn the **MASTER VOLUME** dial or press the **VOLUME ▲/▼** buttons to adjust the sound level.
 - OR-
 - Press **MUTE** on the remote to turn the sound off. **MUTE** flashes on the display. Press **MUTE** again to turn the sound back on.
- For additional information on using your receiver, refer to the *User Guide*.

Features

Front controls

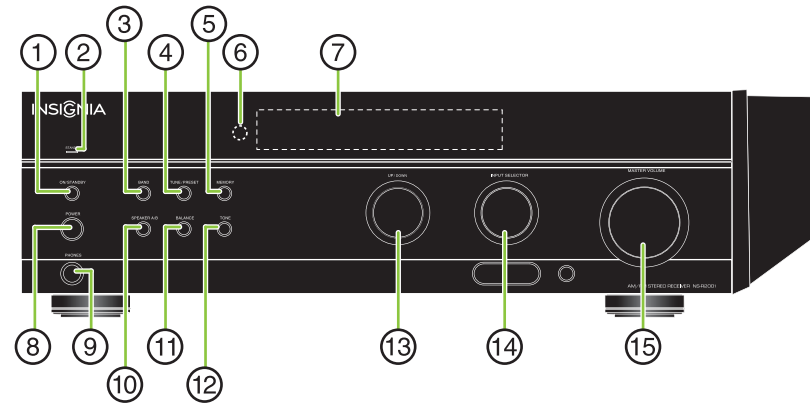

Back view

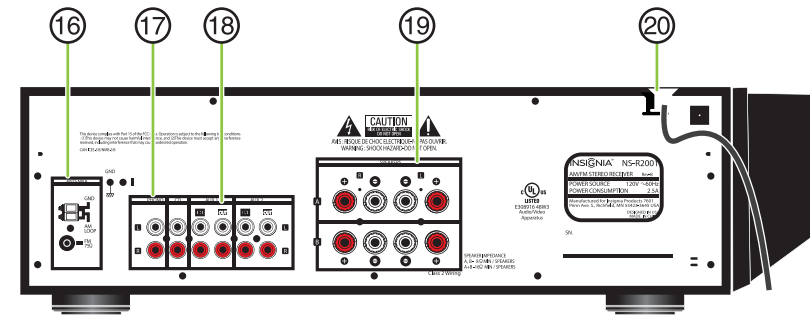

Display

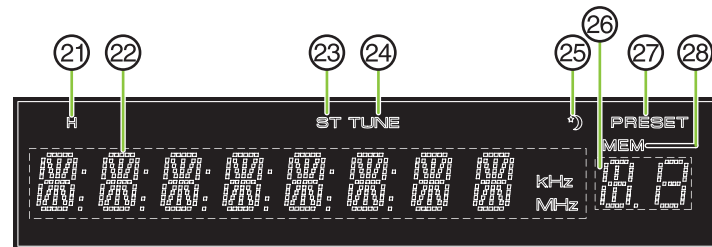

#	Description	Function
1	ON/STANDBY button	Press to turn on your stereo receiver. Press again to put the stereo receiver in standby mode.
2	STANDBY indicator	Lights blue when your stereo receiver is in standby mode.
3	BAND button	Press to toggle between AM and FM.
4	TUNE/PRESET button	Press to toggle between tune and preset mode.
5	MEMORY button	Press to save a station preset. Press and hold to automatically search for FM stations and store them in memory.
6	Remote sensor	Receives the signal from the remote control.
7	Display	Provides information about the receiver.
8	POWER button	Press to power on the stereo receiver putting it into standby mode. Press again to power down the stereo receiver.
9	HEADPHONE jack	Plug 1/4" stereo headphones into this jack.
10	SPEAKER A/B button	Press to toggle between speakers: A, B, A&B, and Off.
11	BALANCE button	Press to turn the balance mode on.
12	TONE button	Press to turn the tone mode on.
13	UP/DOWN knob	Turn to tune the radio frequency up or down, or to adjust such as tone or balance, depending on the receiver mode.
14	INPUT SELECTOR knob	Turn to cycle through the available receiver inputs.
15	MASTER VOLUME control knob	Turn to increase or decrease the volume.
16	AM and FM antenna jacks	Connect the AM and FM antennas to these jacks.
17	PHONO jacks	Connect a turntable to these jacks.
18	Audio input jacks	Connect audio input devices to these jacks to play their audio through your receiver.
19	Speaker terminals	Connect speakers to these terminals.
20	AC power cord	Plug this cord into an AC power outlet.
21	Headphone indicator	Lights when in Headphone mode and headphones are connected.
22	Display indicator	Shows input, frequency, volume level, and operating information.
23	STEREO indicator	Lights when in FM stereo mode.
24	TUNE indicator	Lights when tuned to a radio station.
25	SLEEP indicator	Lights when the sleep timer is active.
26	PRESET/Sleep time indicator	Shows preset number or sleep time remaining.
27	PRESET indicator	Lights to indicate that the receiver will scan through preset radio channels when tuning.
28	MEMORY indicator	Lights when setting preset channels.

Remote control

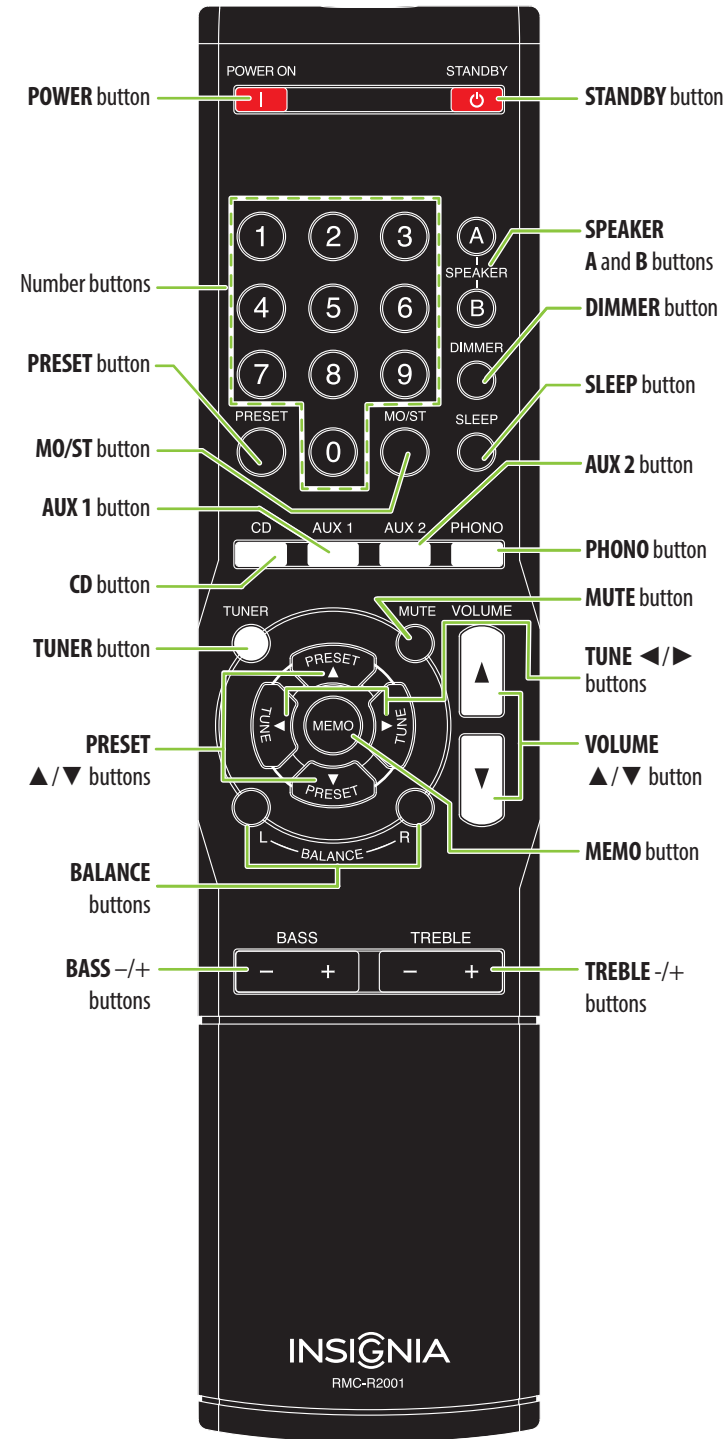

FCC Statement

This device complies with Part 15 of the FCC Rules. Operation is subject to the following two conditions: (1) this device may not cause harmful interference, and (2) this device must accept any interference received, including interference that may cause undesired operation. This equipment has been tested and found to comply with the limits for a Class B digital device, pursuant to Part 15 of the FCC Rules. These limits are designed to provide reasonable protection against harmful interference in a residential installation. This equipment generates, uses and can radiate radio frequency energy and, if not installed and used in accordance with the instructions, may cause harmful interference to radio communications. However, there is no guarantee that interference will not occur in a particular installation. If this equipment does cause harmful interference to radio or television reception, which can be determined by turning the equipment off and on, the user is encouraged to try to correct the interference by one or more of the following measures:

- Reorient or relocate the receiving antenna.
- Increase the separation between the equipment and receiver.
- Connect the equipment into an outlet on a circuit different from that to which the receiver is connected.
- Consult the dealer or an experienced radio/TV technician for help.

FCC warning: Changes or modifications not expressly approved by the party responsible for compliance with the FCC Rules could void the user's authority to operate this equipment.

Canadian Notice

CAN ICES-3 (B)/NMB-3(B)
Standard Television Receiving Apparatus — Appareil de réception télévision ordinaire,
Canada BETS-7 / NTMR-7.

One-year limited warranty

Visit www.insigniaproducts.com for details.

Contact Insignia:

For customer service, call 1-877-467-4289 (U.S. and Canada) or 01-800-926-3000 (Mexico)
www.insigniaproducts.com

INSIGNIA is a registered trademark of BBY Solutions, Inc. Registered in some countries.
Distributed by Best Buy Purchasing, LLC, 7601 Penn Ave South, Richfield, MN 55423 U.S.A.
©2013 BBY Solutions, Inc. All Rights Reserved.