

hohem

iSteady **M7**

User Manual v1.2

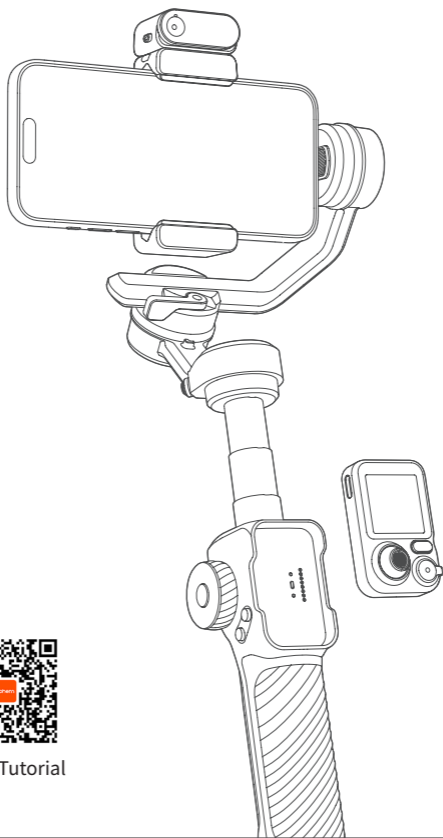

Video Tutorial

Contents

01 Product List	01
02 Overview	02
03 Charging	04
04 Mounting & Powering On	05
Tripod Installation & Axes Unlocking	05
Mounting & Balancing	05
Powering on & Standby	05
05 Bluetooth Connection	06
06 Usage Modes	07
07 Button & Port Functions	08
08 Working Modes	09
Working Modes	09
Manual Tilt Adjustment	09
09 AI Tracking	10
Mount the AI Tracker	10
Turn on the AI Tracker	10
Gesture Control (Only for Person)	10
Touchscreen Control (For Any Subject)	11
Front/Rear Tracking	11
10 Buttons on Remote	12
11 Touchscreen Interface	13
12 Indicators	14
13 Hohem Joy App	15
14 Auto Calibration & Firmware Update	16
15 Specifications	17
16 Call Center - Toll Free	18

01 Product List

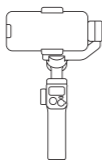

iSteady M7



Advanced AI Tracker with Fill Light



Detachable Touchscreen Remote Controller



Tripod



Carrying Case



USB-Type C Charging Cable



Type C-Type C Charging Cable*



Quick Start Guide



Warranty Card



Safety Guidelines

*For reverse charging, connect the black end to your phone and the gray end to the gimbal. For AI tracker updates, connect the gray end to your phone and the black end to the gimbal. It's recommended to update it through Hohem Joy app.

02 Overview

Front

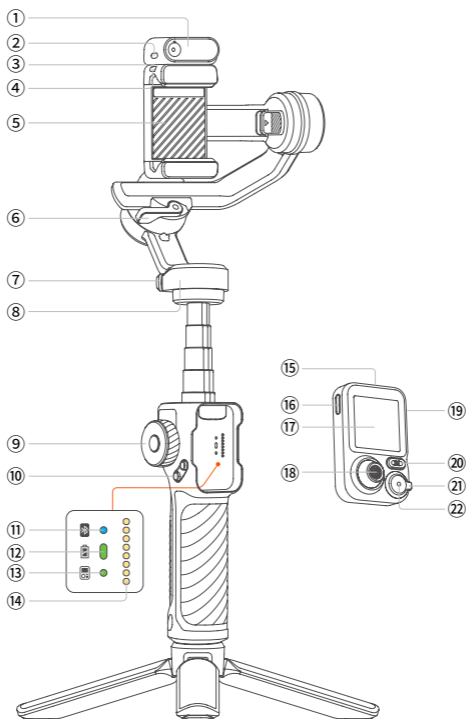

- | | |
|---------------------------------------|-----------------------------------|
| ① Advanced AI tracker with Fill Light | ⑫ Gimbal Battery Indicator |
| ② AI Tracker Power Switch | ⑬ Remote Connection Indicator |
| ③ Magnetic Mount | ⑭ Pogo Pins |
| ④ Safety Locks | ⑮ Detachable Remote Controller |
| ⑤ Phone Clamp | ⑯ Charging Port (Type C) |
| ⑥ Roll Arm Latch | ⑰ 1.4-inch Full-Color Touchscreen |
| ⑦ Pan Lock | ⑱ Joystick |
| ⑧ Pan Motor | ⑲ Side Button |
| ⑨ Side Roller | ⑳ Mode Button |
| ⑩ A/B Button | ㉑ Zoom Lever |
| ⑪ Bluetooth Indicator | ㉒ Shutter Button |

Rear

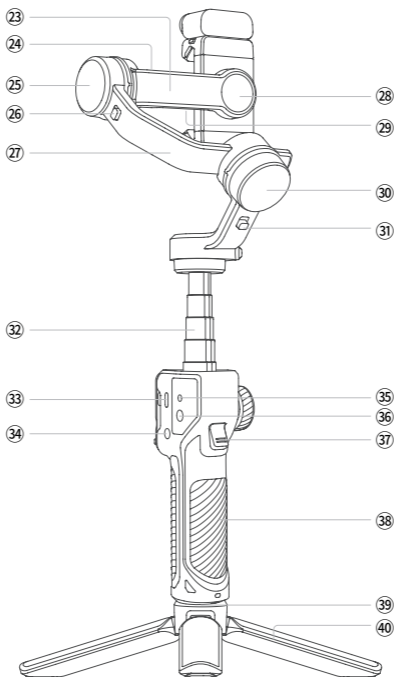

- | | | | |
|----|--------------------------------|----|------------------------|
| 23 | Tilt Arm | 32 | Extension Pole |
| 24 | 1/4"-20 UNC Port | 33 | Charging Port (Type C) |
| 25 | Tilt Motor | 34 | Power Button |
| 26 | Tilt Lock | 35 | Positioning Hole |
| 27 | Roll Arm | 36 | 1/4"-20 UNC Port |
| 28 | Landscape/Portrait Switch | 37 | Trigger |
| 29 | Reverse Charging Port (Type C) | 38 | Handle |
| 30 | Roll Motor | 39 | 1/4"-20 UNC Port |
| 31 | Roll Lock | 40 | Tripod |

03 Charging

Please fully charge iSteady M7 before using it for the first time.

Charging Method:

Please use the standard USB-Type C charging cable to connect to the Type-C charging port on the gimbal handle for charging.

*It is recommended to use a 5V-3A USB charger (not included, needs to be provided separately).

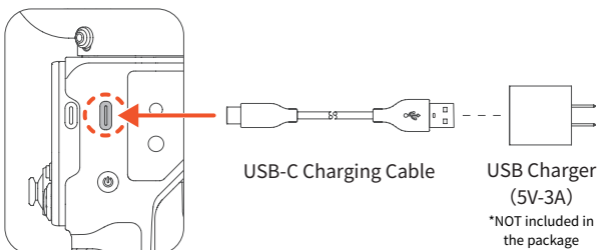

Charging Display:

The battery is fully charged when the battery levels reach the highest point as shown on the display.



Reverse Charging (DC out charging for smartphones):

Connect the charging cable to the Type-C reverse charging port on the tilt arm.

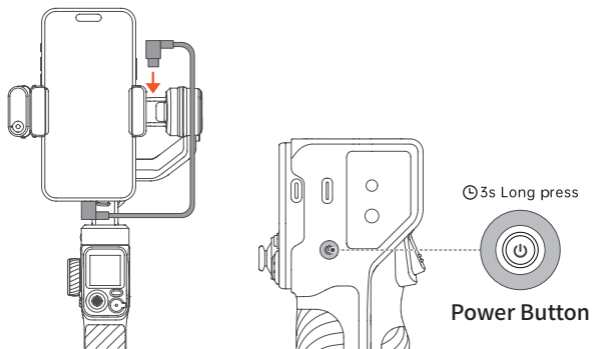

Tips:

- ① The package includes a Type-C to Type-C charging cable for reverse charging. Connect the black end to your phone and the gray end to the gimbal. If your phone has a Lightning connector, use your own Type-C to Lightning cable.
- ② When the gimbal is powered off, press the power button once to start charging your smartphone.

04 Mounting & Powering On

Compatible smartphones:
≤ 7 inches (weight: ≤ 500g,
width: 58mm-90mm, thickness:
≤ 12.5mm)



Video
Tutorial

Tripod Installation & Axes Unlocking

a. Attach the tripod to the bottom of the handle.
Unfold the tripod and place the gimbal on a flat surface.

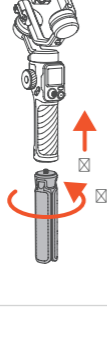

b. Each axis of the gimbal is equipped with a lock for easy storage and setup. The gimbal is packaged in the locked position. You can unlock it as shown below.

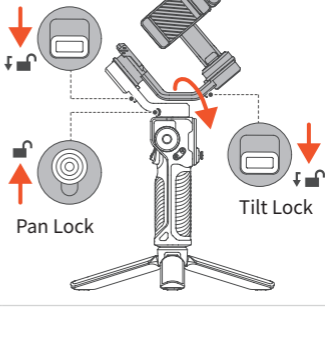

Mounting & Balancing

Landscape

a. Attach the phone clamp to the center of the phone. Ensure the smartphone is snug against the phone clamp and the motor. When mounting for landscape shooting, make sure the phone's camera is positioned on the left side.

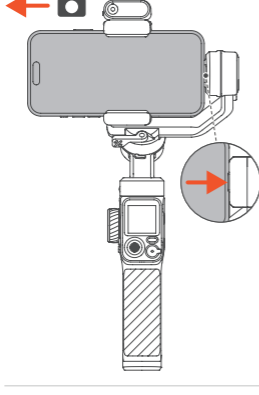

b. Unlock the roll arm latch and push the arm to the left or right until the phone is steady and almost at level with the ground. Then tighten the latch.

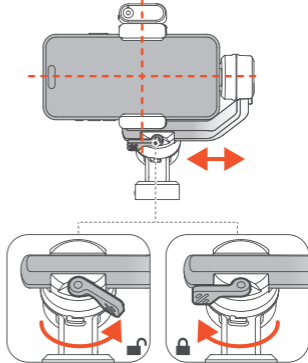

Portrait

a. Rotate the phone clamp by 90° to the left as shown.

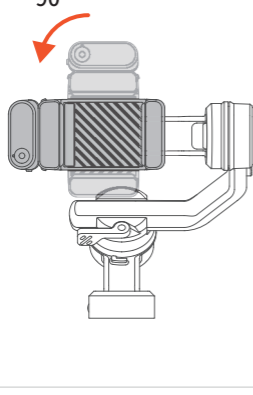

b. Attach your mobile phone with the camera positioned on the top.

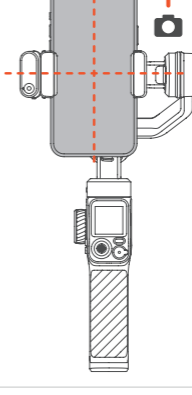

c. Adjust the roll arm to the left or right until the phone is steady and almost at level with the ground.

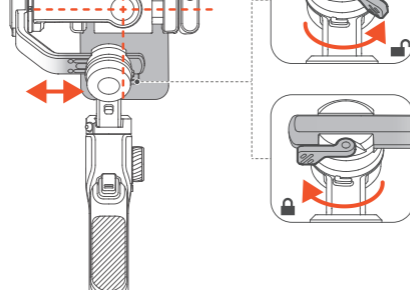

Quick Switch to Portrait Mode

Hold the gimbal vertically, and tilt the handle as shown until the smartphone automatically switch to portrait mode. Then slowly rotate the handle and hold it horizontally.

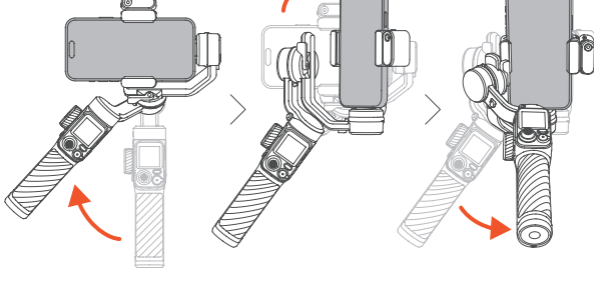

Tips: After switching to portrait mode, the joystick only controls the phone's left and right rotation. Note that quick switch to vertical mode is not supported in POV mode.

Powering on & Standby

Make sure the tilt, roll, and pan locks are in the unlocked position before using the gimbal.

Powering On

1. When the remote is attached to the handle, long press the shutter button to power on the gimbal and the remote controller.

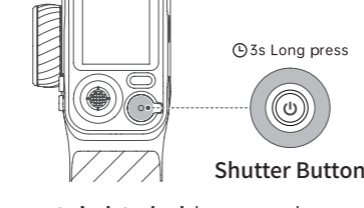

2. When the remote is detached, long press the power button on the handle to power on the gimbal. Long press the shutter button on the remote to power on the remote controller.

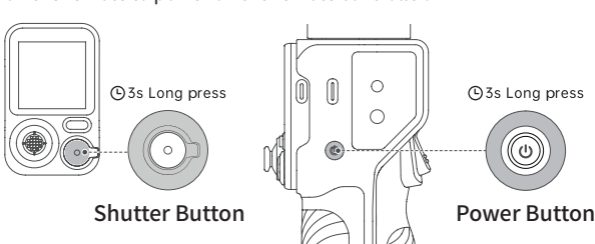

Standby

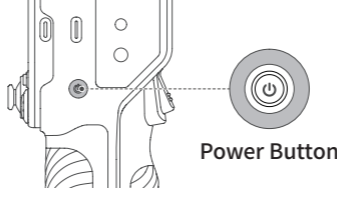

Double press: Enter the standby mode
Double press again: Wake up the gimbal

Ultra-Wide-Angle Mode

Default mode as shown in the image 1: There's no obstruction in front of phone screen.

Ultra-wide-angle shot mode as shown in the image 2: The roll motor shifts to the front side of the phone screen to avoid appearing in rear shots.

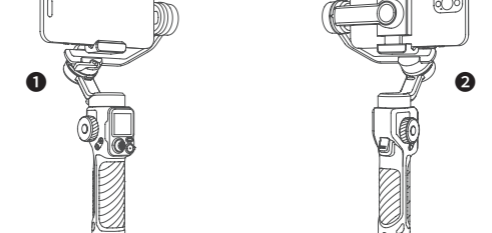

05 Bluetooth Connection



1. Make sure the gimbal is powered on.
2. Activate Bluetooth on your smartphone and select the device named "iM7-XXXXXXX" from the list of available devices.
3. Follow the on-screen instructions to connect and pair.
4. A steady light on the Bluetooth indicator signifies a successful connection.

Unable to find my gimbal in the Bluetooth device list, or the gimbal's Bluetooth is connected to another phone?

To resolve this, clear the gimbal's Bluetooth information and reconnect by following these steps:

- ① Press the side roller seven times. The Bluetooth icon on the display will indicate that the Bluetooth connection has been cleared.
- ② Follow the Bluetooth connection instructions to reconnect.

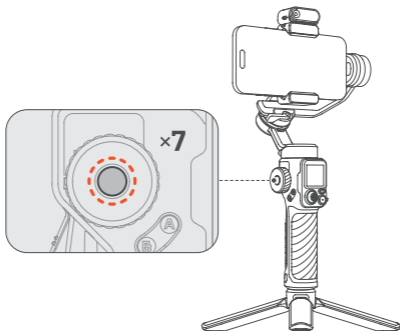

06 Usage Modes

There are 3 main usage modes of iSteady M7: **Handheld Mode**, **Extended Mode**, and **Remote Mode**. You can combine and use them as needed during actual shooting.

Handheld Mode

Simply hold the gimbal for on-the-go shooting.

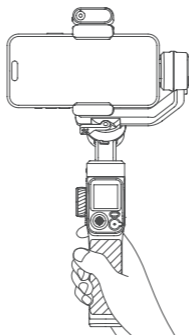

Extended Mode

Pull out the built-in extension pole upwards for shooting.

*The extension rod includes five segments with a maximum length of 193mm.



*It is recommended to retract the extension rod after use, as prolonged stretching may cause deformation.

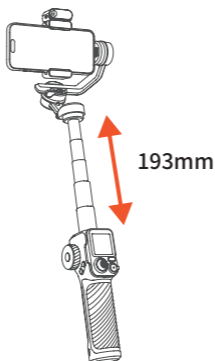

Remote Mode

Attach the tripod to the handle and stand the gimbal on a flat surface. Then remove the remote controller for remote shooting.

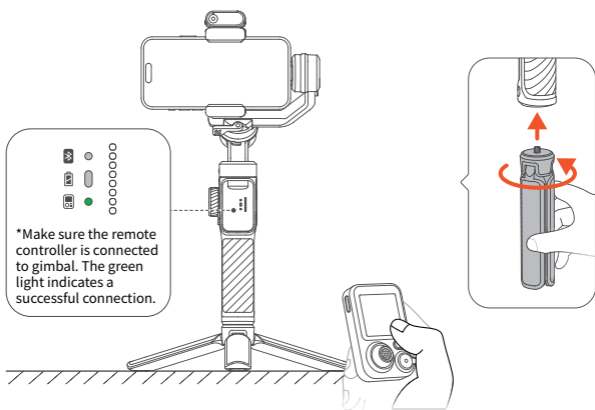

07 Button & Port Functions



Video Tutorial

Scan the QR code to view tutorials, or visit www.hohem.com for more information.

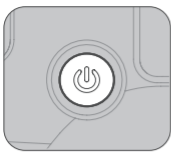

Power Button

Long press: On/Off

Single press: Reverse charging (in power off state)

Double press: Enter/Exit standby mode

Press five times: Auto gimbal calibration



Trigger

Single press:

① Start AI tracking (used in preview[1] with tracking target selected)

② Pause/Resume AI tracking (used in preview[1] during tracking)

Double press: Recenter the gimbal

Triple press: Forward-facing/Backward-facing phone position

Press four times: Ultra-Wide-Angle Mode

press and hold: All Lock Mode

Single press + Press and hold: Sports Mode [1]

For more information refer to the [09 AI Tracking - Touchscreen Control](#) section.

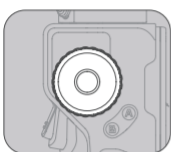

Side Roller

*Press the button to select the function, then rotate the wheel for smooth adjustment.

① Fill Light Control

Long press: Turn on/off the fill light

Triple press: Switch to CCT/RGB

Single press: Submenu switch (brightness/color)

② Motor Rotation

Double press: Select motor control (under focus and motor control)

Single press: Submenu switch (pan/tilt/roll)

③ Focus Control

Double press: Select focus control (under focus and motor control)



A-B Button

Set the starting and ending point for track shooting or time-lapse footage along a designated path.

Note: This function should be used separately from the time-lapse feature in the Hohem Joy app.

Setting position A: Move the camera angle with the joystick to the start point, position A and long press Button A to set. A short beep means successful setting.

Setting position B: Move the camera angle with the joystick to the end point, position B and long press Button B to set. A short beep means successful setting.

A-B motion: Single press button A to return to position A from the current position, and then double press Button B to start A-B motion at a constant speed.

B-A motion: Single press button B to return to position B from the current position, and then double press Button A to start B-A motion at a constant speed.

*Duration by default: 1 minute. You can customize duration in the Hohem Joy app or through the touchscreen of the remote.

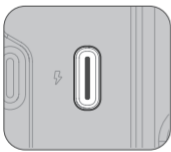

Charging Port (Type C)

Connect to a power source to charge the gimbal.



Reverse Charging Port (Type C)

Connect a charging cable to provide reverse charging for your mobile device.



1/4''-20 UNC Port

The 1/4''-20 UNC port on the bottom of the gimbal allows for connection to a tripod or other extension poles. The 1/4''-20 UNC Port on the tilt arm and the side of the handle can be used to attach creative accessories such as microphones or fill lights.

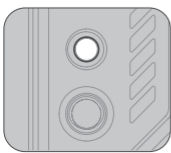
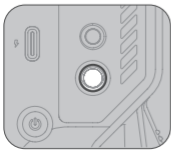
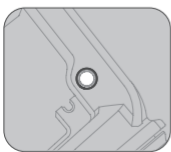

Sling Handgrip Port

This area is designated for installing the mounting plate of the Hohem sling handgrip.

08 Working Modes

Working Modes

iSteady M7 includes three axes of rotation: pan, tilt, and roll axes. The collaborative work between different axes results in the creation of 4 operation modes, each tailored to specific filming needs:

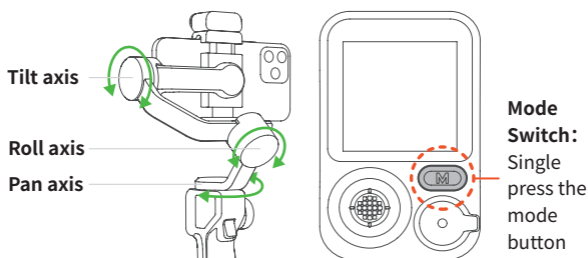

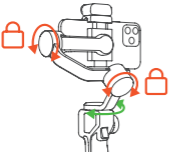
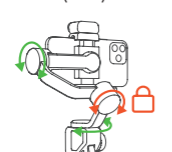
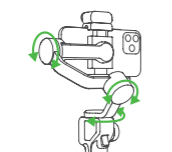
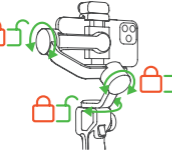
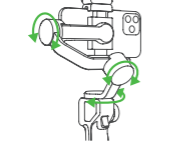
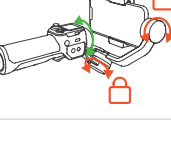
Working Mode	Description	Functionality
Pan Follow (PF) 	Pan axis is active.	The gimbal allows the phone to pan left or right smoothly following the operator's movements, while maintaining a steady tilt and roll position.
Pan and Tilt Follow (PTF) 	Both Pan and Tilt axes are active.	This mode enables the phone to follow the operator's pan (left/right) and tilt (up/down) movements, offering more dynamic control over the framing. The roll axis remains locked to keep the horizon level.
Point of View (POV) 	All three axes (Roll, Tilt, and Pan) are active.	This mode allows the phone to follow the operator's movements in all directions. It offers a 'first-person' perspective, capturing footage as if the viewers are seeing through the operator's eyes.
Custom 	Enables or disables the follow mode for each axis as needed.	This mode allows you to custom the follow mode for each axis, such as disabling all three axes to enter All Lock Mode. *In All Lock Mode, none of the three axes will follow the movement of the grip.
Sport Mode (S) 	The follow speed of the gimbal increases for capturing quick-moving subjects and any fast paced action.	Ideal for capturing fast-moving scenes where quick adjustments are necessary, like sports, wildlife photography, or action shots.
Inception Mode (ICP) 	360° infinite spin on pan axis while holding the gimbal horizontally.	Great for artistic shots, cinematic storytelling, or any situation where a dramatic perspective change can enhance the visual narrative.

Manual Tilt Adjustment

The tilt motor can be rotated by a certain angle by hand. Hold it for 2s and the camera angle will be fixed at that angle.

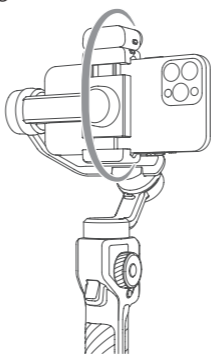

09 AI Tracking



Video Tutorial

Scan the QR code to view tutorials, or visit www.hohem.com for more information.

Mount the AI Tracker

Attach the magnetic AI tracker, make sure it is aligned with the magnetic mount.

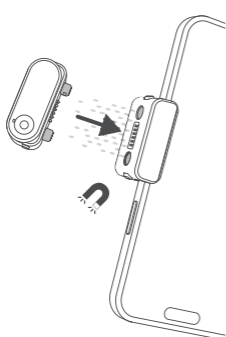

Turn on the AI Tracker

Toggle the switch to "ON". The fill light will flash twice quickly to indicate successful activation.

*Toggle the switch to "OFF" to turn off the AI Tracker.

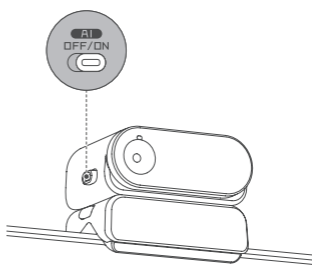

Gesture Control (Only for Person)

Show gestures to the AI Tracker from 0.5m~5m/1.64-16.40ft away.

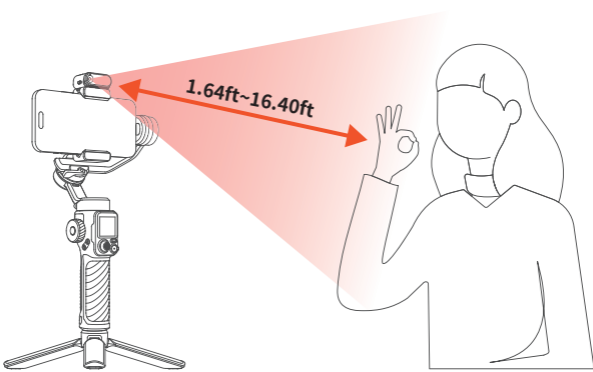

Start AI Tracking

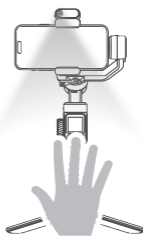

Stop AI Tracking

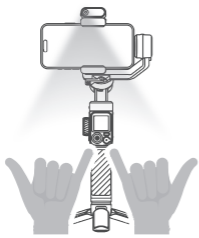

Shutter Control

*Bluetooth connection needed.

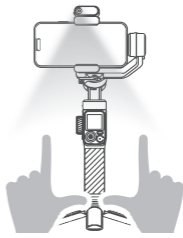

Customized Composition

*Steps: ① ② Move to the ideal position ③

Customized Composition

When you use AI tracking for the first time, the AI tracker will keep you centered on the phone screen as it follows you. If you want to adjust your position to create more dynamic visual effects, follow the steps below:

- ① Make sure AI tracking is enabled. At this time, the AI indicator is solid green.
- ② Take the gesture towards the AI vision sensor and the indicator will blink green quickly.
- ③ Move in front of the screen until you find the preferred position to be tracked.
- ④ Show the gesture again to confirm your new composition.



Video Tutorial

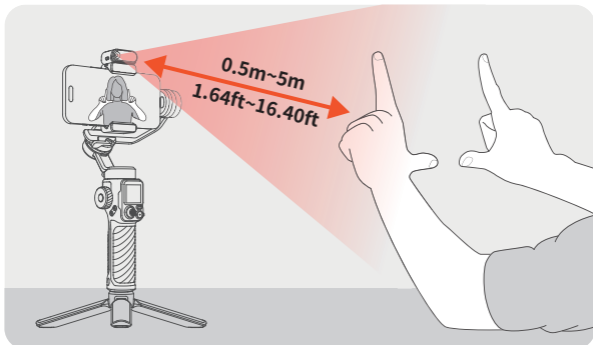

Touchscreen Control (For Any Subject)



Video
Tutorial

Scan the QR code to view tutorials,
or visit www.hohem.com for more
information.

Enter Real-Time Preview

*Ensure that the AI tracker is turned on.

a. Swipe right on the homepage.

b. Real-time AI tracking preview.



Tracking Method 1: Double Tap

a. Double tap the tracking target.

b. AI tracker recognizes the target and starts tracking.



Tracking Method 2: Drag Selection

a. Drag-select the tracking target.

b. Single press the side button/
trigger to start tracking.

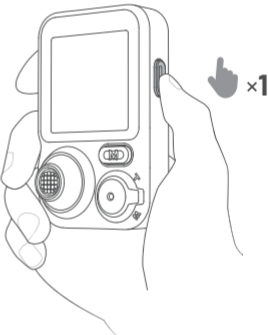

Tips: ① During tracking, single press the side button/trigger to pause/resume AI tracking.

② Triple tap the screen to stop AI tracking.

How to Perform AI Tracking Calibration?

When previewing the AI tracking footage with the controller, there may be discrepancies between the controller's and the phone's display due to variations in phone camera positions. To calibrate the screen, follow these steps:

a. Long press the side button on the controller to enter AI Tracking Calibration.

b. Use the joystick to adjust the controller's display, ensuring it aligns with the phone's.

c. Long press the side button again to confirm the controller's display and exit AI Tracking Calibration.

Front/Rear Tracking

Press and hold the safety locks on both sides of the phone clamp at the same time to unlock it. Remove the AI tracker, rotate it 180°, and then mount the AI tracker.

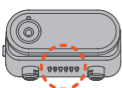
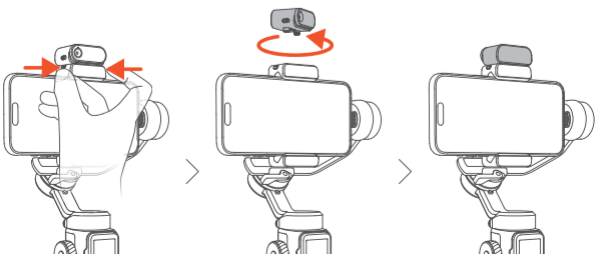

① Attempting to remove the AI tracker without unlocking it first may result in structural damage to the product.

② When using the AI tracker, it is normal for the pogo pins at the bottom to become hot. Please avoid direct contact to prevent burns!

10 Buttons on Remote



*Note:

- ① When attached to the gimbal, the remote control automatically powers on and pairs once the gimbal is on. The gimbal also charges the remote during this time.
- ② If detached from the gimbal, the remote needs to be powered on separately. It will automatically pair with the gimbal upon powering on.

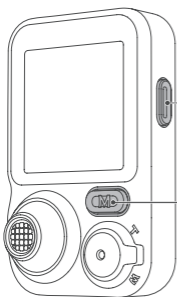

Side Button

Single press: ① Start AI tracking (used in preview[1] with target selected)

② Pause/Resume AI tracking (used in preview[1] during tracking)

Double press: Recenter the gimbal

Triple press: Forward-facing/
Backward-facing phone position

Press four times: Ultra-Wide-Angle Mode

Press five times: Re-pair the remote controller (Press the side roller on the gimbal five times)

Press seven times: Clear the remote connection

Long press: AI tracking calibration [1] For more information refer to the [09 AI Tracking - Touchscreen Control](#) section.

Mode Button

Single press: Switch working mode

Triple press: 360° infinite pan rotation

Press five times: Auto gimbal calibration

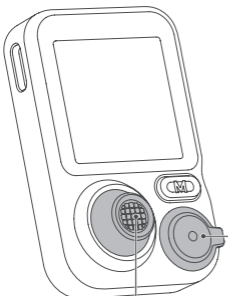

Zoom Lever

Lever up/down: Zoom in/out[1]

Shutter Button

Half-press: Auto focus[1]

Single press: Take a photo or start/stop recording[2]

Double press: Photo/Video[1]

Triple press: Front/Rear camera[1]

Long press: Power on/off the remote[3]

1. Used within Hohem Joy app after Bluetooth connection.

2. Bluetooth connection needed.

3. When the remote is attached to the handle, it will power on/off the gimbal simultaneously.

Joystick

Push up/down: Tilt up/down

Push left/right: Pan left/right

*In AI tracking calibration mode, use the joystick to adjust the preview frame.

11 Touchscreen Interface

Status Bar



Bluetooth Connection: Connected; Disconnected

AI Tracking: On; Pause;
 Stop

Remote Connection: Connected

Gimbal Battery: <100%;
 <75%; <50%; <25%;
 Shutting down soon

Remote Controller Battery: <100%; <75%;
 <50%; <25%; Shutting down soon

Homepage



- Roller Control**
- Motor Balance**
- Gimbal Working Mode**
- Scenarios**
(Inception, Ultra-Wide-Angle Shot, Panorama, Motion Timelapse)



- Joystick Setting**
- A/B Setting**
- Follow Speed**
- More Settings**

Real-Time Preview

a. Swipe right on the homepage.



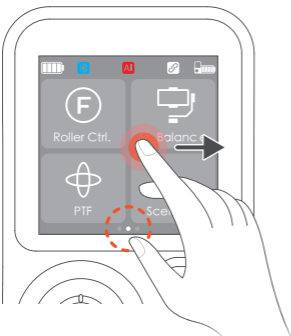

b. Real-time AI tracking preview.

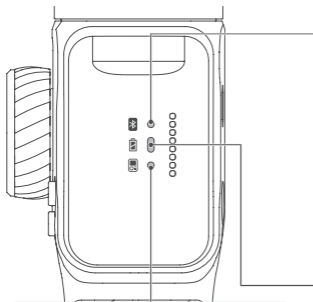





12 Indicators









Bluetooth Indicator

-  **Solid:** Bluetooth Connected
-  **Quick flash*3:** Connection cleared
-  **Slow flash:** Firmware updating
-  **Off:** Disconnected

Gimbal Battery Indicator

-  **Solid:** 50%~100%/Fully charged
-  **Solid:** 25%~50%
-  **Solid:** < 25%
-  **Quick flash:** Shutting down soon

Remote Connection Indicator

-  **Solid:** Remote connected
-  **Quick flash*3:** Power on/off
-  **Slow flash:** Repairing
-  **Off:** Disconnected
-  **Slow flash:** Gimbal overloading
-  **Solid:** Firmware anomaly
-  **Pulse:** Gimbal standby

13 Hohem Joy App

Downloading

Scan the QR code or search "Hohem Joy" in App Store / Google Play to download the App.



Gimbal Connection

- ① Attach your smartphone and turn on iSteady M7.
- ② Turn on Bluetooth on your smartphone.
- ③ Open the Hohem Joy App. Follow the on-screen instructions to complete the connection.

Camera Interface



* The camera interface is subject to change due to updates of Hohem Joy App version.

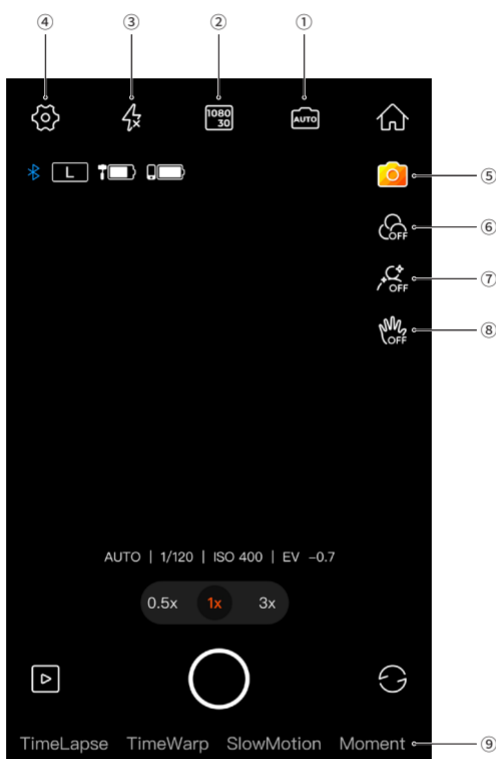

- | | | |
|---|----------------------------------|--|
| ① | Shooting Parameters | Set shutter speed, ISO and EV. |
| ② | Resolution and Frame Rate | Set resolution and video frame rate. |
| ③ | Flash | Adjust the flash. |
| ④ | General Settings | Includes gimbal parameters*, camera parameters, and gimbal information.
*You can configure the gimbal to default to either landscape or portrait mode upon startup. |
| ⑤ | Creative Studio | Provides shooting tutorials and ideas according to the situation or environment. |
| ⑥ | Filter | Select a photo or a video filter. |
| ⑦ | Beauty | Select from auto, slim face, or big eyes beauty modes. |
| ⑧ | Gesture Control | Enables person tracking and shutter control.
*For object tracking through app, you can drag-select the target on the phone screen. |
| ⑨ | Moment Templates | Various video templates are available; simply tap to start, and the camera will automatically execute the moves to create a video. |



For more information, visit www.hohem.com, or scan the QR code to view tutorials.

14 Auto Calibration & Firmware Update

Auto Calibration

Auto calibration could reduce drift or slight deviation caused by nearby magnetic interference or human error.

① Place the gimbal on a hard, flat surface after setting it up and powering it on.

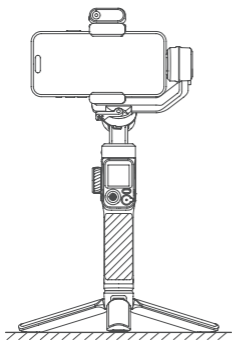

② Press the trigger button twice to recenter the gimbal.

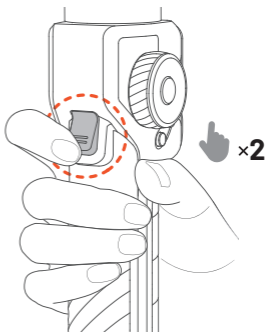

③ Press the M button five times to enter auto calibration.

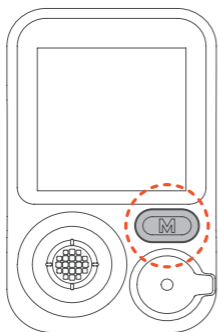

④ A single "beep" indicates that the calibration is complete.

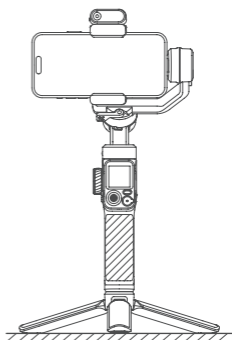

*Note:

- ① During the auto calibration process, ensure that the remote control is connected to the gimbal.
- ② Failing to place the gimbal on a flat surface for calibration will result in calibration failure (e.g., attempting calibration while holding it in a vehicle).
- ③ If calibration fails, you'll hear two beeps and see the Working Mode indicators pulsing, indicating standby mode. Double-tap the power button to exit standby and retry calibration.

Firmware Update

You will be prompted in the Hohem Joy App if a new firmware update is available. Follow the on-screen instructions in the App to update firmware.

15 Specifications

iSteady M7

Weight	Gimbal: 629g(±5g) Tripod: 118.5g
Dimensions	Unfolded: 327*122.3*118.3mm Folded: 335.7*57*159mm
Material	High-performance composite material
Maximum Load	500g
Mobile Phone Width	58mm~90mm
Battery Capacity	18650li-ion 7.2V/3200mAh/23.04Wh
Operating Time	Approx. 12 hours (Balanced and stationary) Approx. 8 hours (With AI tracking) 3~4 hours (With AI tracking and fill light used simultaneously) *Data sourced from Hohem Laboratory
Power Consumption	1.8W (Balanced and stationary)
Charging Time	3 hours (5V-3A)
Controllable Angle	Pan: 360° Infinite Roll: ±45° Tilt: -50° ~275°
Motor Protection	The gimbal will automatically shut down in case of improper operation to protect the motor.
Working Temperature	-10° C ~ 40° C
Motors Protection	The motor can be protected from damage caused by improper operation by having the gimbal powered off automatically.

Remote Controller

Battery Capacity	3.85V/240mAh/0.924Wh
Remote Control Range	≤ 10m(≤ 32.81ft)
Wireless Video Transmission Range	≤ 7m(≤ 22.97ft)
Touchscreen	1.4 inches

AI Tracker

Weight	20g
Dimensions	42.5*29.5*19.5mm
Pixel	2 MP
Gesture Recognition Distance	0.5m~5m(1.64ft~16.40ft)
Tracking Distance	0.5m~7m(1.64ft~22.97ft)
Illuminance	40lux@0.5m
Light Power	2W
RGB	360 lighting colors
CCT	2700K, 3000K, 3500K, 4000K, 4500K, 5000K, 5500K, 6000K, 6500K

16 Call Center - Toll Free

UNITED STATES:

+1(888)9658512

Mon-Fri: 9:00AM-5:00PM(EST)

UNITED KINGDOM:

+44(0)808 2737578

Mon-Fri: 2:00PM-10:00PM(GMT +0)

CANADA:

+1(855)758 8939

Mon-Fri: 9:00AM-5:00PM(EST)

BRAZIL:

+55 (0)800 5911897

Mon-Fri: 10:00AM-6:00PM(GMT -3)

hohem

Email: service@hohem.com

Website: www.hohem.com

Manufacturer: Shenzhen Hohem Technology Co., Ltd.



Connect us at
Facebook