

LED STRAIGHT LIGHT BAR

STL50LB



50-INCH STRAIGHT LED LIGHT BAR

User Manual

BOX CONTENTS

- One (1) Straight 50-inch LED light bar
- One (1) 18-inch harness with Deutsch connectors
- Two (2) light bar mounting brackets
- Mounting hardware

FEATURES

- Trail-ready compact design
- High-output LED light engine
- Durable HEXCORE aluminium housing
- Combo beam pattern
- White or Amber backlit position light
- Weather-sealed design for harsh environments
- Universal mounting system

TECHNICAL SPECIFICATIONS

- Operating Voltage: 10-30V DC
- Light Source: High-intensity LEDs
- Housing Material: Die-cast aluminium
- Lens Material: Polycarbonate
- Ingress Protection: IP67
- Operating Temperature: -40°F to 149°F (-40°C to 65°C)

REQUIRED TOOLS

- 17mm wrench or 17mm socket and ratchet
- 5mm Allen wrench
- Wire crimpers / strippers

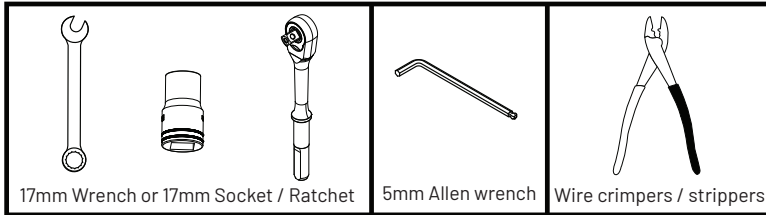

WIRING

PIN	WIRE COLOR	FUNCTION	VEHICLE WIRING
PIN 1	Yellow	Amber position light	External 12V switch
PIN 2	White	White position light	External 12V switch
PIN 3	Green	Low beam switch	External 12V switch
PIN 4	N/A	No connection	No connection
PIN 5	Black	Ground	Chassis ground
PIN 6	Red	Hi beam power	External 12V switch

Connector is shown from the PIN side



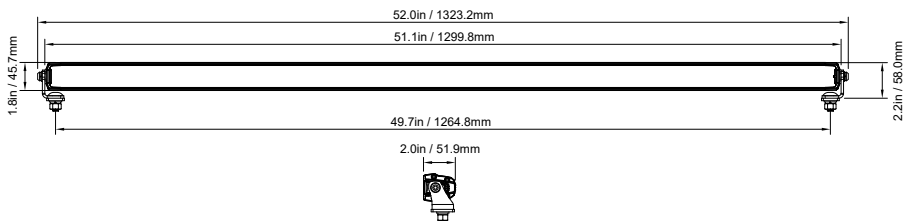







DIMENSIONS

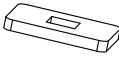

Installation Guide

MOUNTING HARDWARE

- One (1) Left mounting Bracket
- One (1) Right mounting Bracket
- Two (2) Rubber Spacers
- Two (2) M8 X 20mm Black Stainless Bolts
- Two (2) M8 Flat Washers
- Two (2) M8 Lock Washers
- Two (2) M10 X 25mm Black Stainless Bolts
- Two (2) M10 Flat Washers
- Two (2) M10 Lock Washers
- Two (2) M10 Black Stainless Nuts

 MOUNTING BRACKET L	 MOUNTING BRACKET R	 RUBBER SPACER	 M8X 20 BOLT	 M8 FLAT WASHER
 M8 LOCK WASHER	 M10 X 25 BOLT	 M10 FLAT WASHER	 M10 LOCK WASHER	 M10 NUT

- Choose a secure, vibration-free mounting surface (bumper, roof rack, A-pillar, etc.).
- Ensure the lights do not obstruct airflow, visibility, or vehicle components.
- Attach the mounting brackets to the light bar.
- Loosely secure hardware to allow for beam adjustment.
- Mount the assembly to the vehicle using the provided hardware.

Installation Guide

- ◆ Connect the red wire to a positive (+) 12V switch for Hi beam.
- ◆ Connect the green wire to a positive (+) 12V switch for Low beam.
(Red wire must also be powered)
- ◆ Connect the black wire to a clean chassis ground.
- ◆ Connect the yellow wire to a positive (+) 12V switch for amber position light.
- ◆ Connect the white wire to a positive (+) 12V switch for white position light.

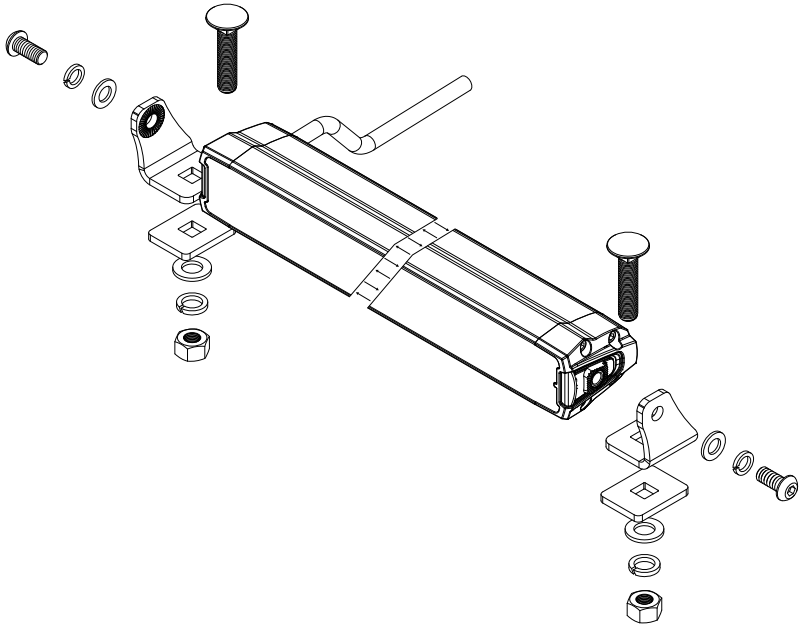



Register Your Product



<https://stingerdrive.com/pages/hexcore-registration>

