

# Parrot Uncle

CEILING FAN

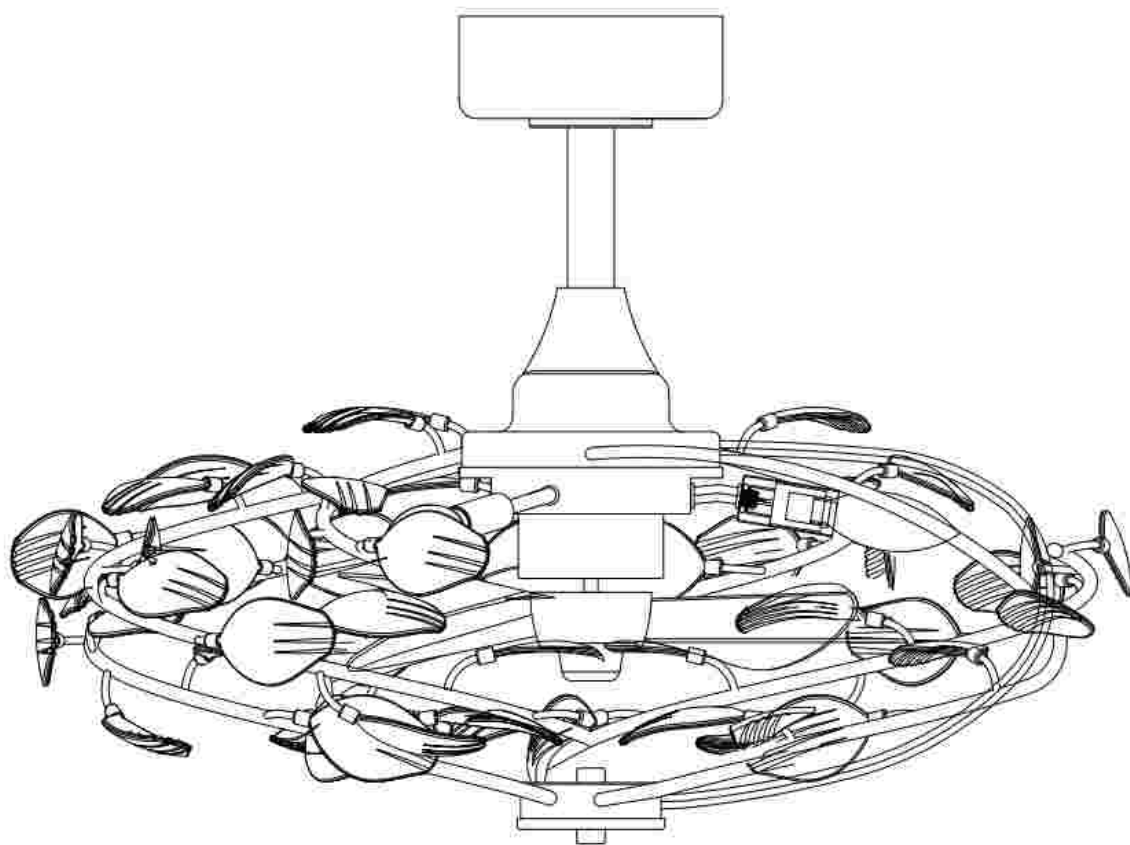

**USE AND CARE GUIDE**

WARNING: SHUT POWER OFF AT FUSE OR CIRCUIT BREAKER

## Safety Information

- 1、 To reduce the risk of electric shock, the electricity has been turned off at the circuit breaker or fuse box before begin.
- 2、 All wiring must be in accordance with the National Electrical Code NASI/NFPA 70-1999 and local electrical codes. Electrical installation should be performed by a qualified licensed electrician.
- 3、 The outlet box and support structure must be securely mounted and capable of reliably supporting 35lb.(15.9kg). Use only UL listed outlet boxes marked "Acceptable for Fan Support of 35lbs(15.9kg)or less."
- 4、 The fan must be mounted with a minimum of 7 ft. (2m) clearance from the trailing edge of the blades to the floor.
- 5、 Do not operate the reversing switch while the fan blades are in motion. You must turn the fan off and stop the blades before you reverse the blade direction.
- 6、 Do not place objects in the path of the blades.
- 7、 To avoid personal injury or damage to the fan and other items, please be careful when working around or cleaning the fan.
- 8、 Electrical diagrams are for reference only. Light kits that are not packed with the fan must be UL-listed and marked suitable for use with the model fan you are installing. Switches must be UL General Use Switches. Refer to the instructions packaged with the light kits and switches for proper assembly.
- 9、 After making electrical connections , spliced conductors should be turned upward and pushed carefully up into the outlet box.The wires should be spread apart with the grounded conductor and the equipment-grounding conductor on one side of the outlet box.
- 10、 All setscrews must be checked and retightened where necessary before installation.



**WARNING:**TO reduce the risk of personal injury, do not bend the blade brackets (also referred to as flanges) during assembly or after installation.Do not insert objects in the path of the blades .



**WARNING:** Remove the rubber motor stops on the bottom of the fan before installing the blades or testing the motor.



**WARNING:** To reduce the risk of fire or electric shock,do not use this fan with any solid-state speed control device.



**WARNING:**To avoid possible electric shock, turn the electricity off at the main fuse box before wiring.If you feel you do not have enough electrical wiring knowledge or experience,contact a licensed electrician.



**WARNING:** Electrical diagrams are for reference only. Optional use of any light kit shall be UL-listed and marked suitable for use with this fan.



**WARNING:** To reduce the risk of fire, electric shock, or personal injury, mount to outlet box marked " Acceptable for fan support of 35 lbs.(15.9 kg)or less " and use the screws provided with the outlet box.

## TECHNICAL INFORMATION

SKU	Nominal voltage	Nominal output (motor)	Light
F3013110V	110V DC	15W	20W ( No light bulb attached )

WARNING: SHUT POWER OFF AT FUSE OR CIRCUIT BREAKER

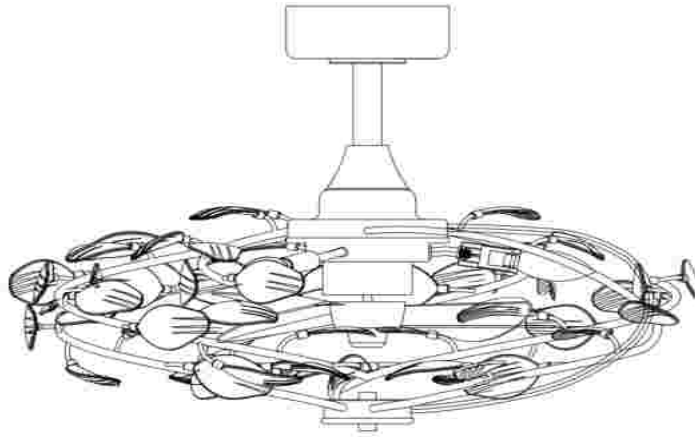

#### THANK YOU FOR YOUR PURCHASE

Thank you for purchasing this quality product. To ensure correct function and safety, please read and save all instructions before using the product

#### SAFETY TIP

1. To avoid possible electric shock, turn off the electricity at the main fuse box or circuit panel before you begin the fan installation or before servicing the fan or installing accessories.
2. Read all instructions and safety information carefully before installing your fan and save these instructions.
3. Make sure all electrical connections comply with local codes or ordinances and the National Electrical Code. If you are unfamiliar with electric wiring, please use a qualified and licensed electrician.
4. Make sure you have a location selected for your fan that allow clear space for the blades to rotate, and at least seven (7) feet of clearance between the floor and the fan blade tips. The fan should be mounted at least thirty (30) inches from walls or other upright structures.
5. WARNING: The outlet box and ceiling support joist used must be securely mounted, and capable of supporting at least 100 pounds. To reduce the risk of fire, electric shock or personal injury, mount to the outlet box marked acceptable for fan supported and use mounting screws provided with the outlet box. The box must be supported directly by the building structure.
6. WARNING: To reduce the risk of fire, electric shock or personal injury, mount to outlet box marked "acceptable for fan support" and use mounting screws provided with the outlet box most outlet boxes commonly used for the support of lighting fixtures are not acceptable for fan support and may need to be replaced. Consult a qualified electrician if in doubt.
7. Electrical diagrams are for reference only. Light kits that are not packed with the fan must UL listed and marked suitable for use with the model fan you are installing. Switches must be UL general use switches. Refer to the instructions packaged with the light kits and switches for proper assembly.
8. After installation is complete, check that all connections are absolutely secure.
9. After making electrical connections, spliced conductors should be turned upward and pushed carefully up into outlet box. The wires should be spread apart with the grounded conductor and the equipment-grounding conductor on one side of the outlet box.
10. WARNING: To reduce the risk of electrical shock and fire, do not use this fan with any solid-state fan speed control device, or rheostat.
11. Do not separate the reverse switch until the fan has come to a complete stop.
12. Do not insert anything into the fan blades while they are rotating.
13. WARNING: To reduce the risk of personal injury, do not bend the blade brackets (also referred to as "flanges") during assembly or after installation. Do not insert objects in the path of the blades.
14. To avoid personal injury or damage to the fan and other items, be cautious when working around or cleaning the fan.
15. Do not use water or detergent when cleaning the fan or fan blades. A dry dust cloth or lightly dampened cloth will be suitable for most cleaning.

NOTE: The important safety precautions and instructions appearing in the manual are not meant to cover all possible conditions and situations that may occur. It must be understood that common sense and caution are necessary factors in the installation and operation of this fan.

NOTE: This product is not intended for use by persons (including children) with reduced physical, sensory or mental capabilities are different or are impaired, or lack of experience or knowledge, unless such persons are supervised or trained to operate the appliance by a person responsible for their safety.

NOTE: Children should be supervised to ensure that they do not use appliances as a toy.

WARNING: SHUT POWER OFF AT FUSE OR CIRCUIT BREAKER



Plastic wire nut (3PCS)



Mounting screws (2PCS)



washer (4PCS)



Wood Screw (4PCS)



Spring Washer (2PCS)



star washers (2PCS)

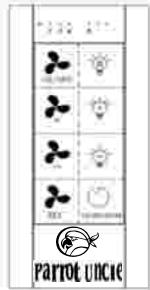

REMOTE CONTROL (1PCS) Plastic wire nut (8PCS)

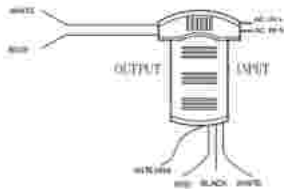

mounting bracket



Canopy

Decorative covers

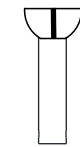

6"ball/downrod assembly



Coupling cover

"R" Locking Pin



Hanging Pin



Fan-motor assembly

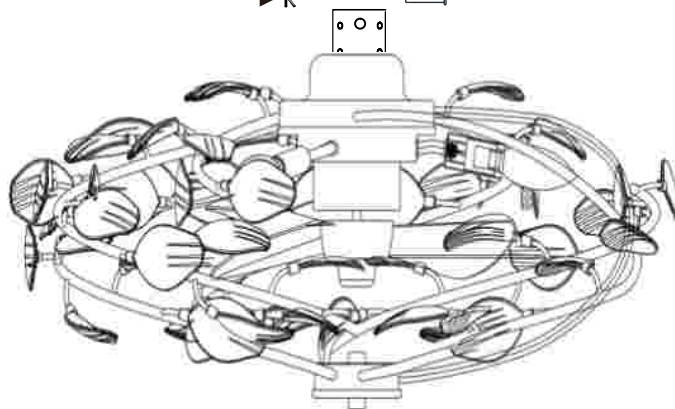

Pls check whether above accessories are completed or not?Yes, and install.

WARNING: SHUT POWER OFF AT FUSE OR CIRCUIT BREAKER

### 1 Attaching the fan to the electrical box



**WARNING:** To reduce the risk of fire, electric shock or personal injury, mount to an outlet box marked "Acceptable for fan support of 35 lbs. (15.9kg) or less," and use the screws provided with the outlet box.



**NOTE:** The mounting bracket(A) is designed to slide into place on an outlet box with the outlet box screws(LL).

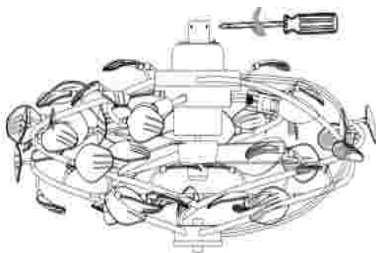
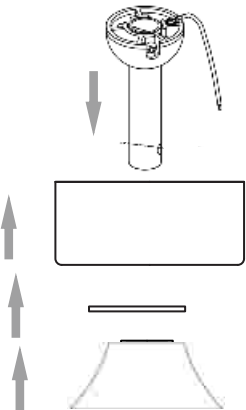
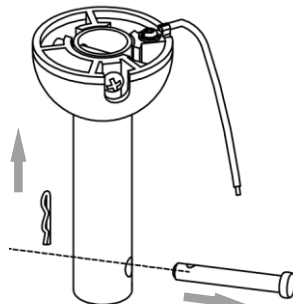
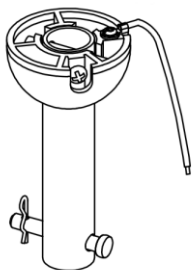
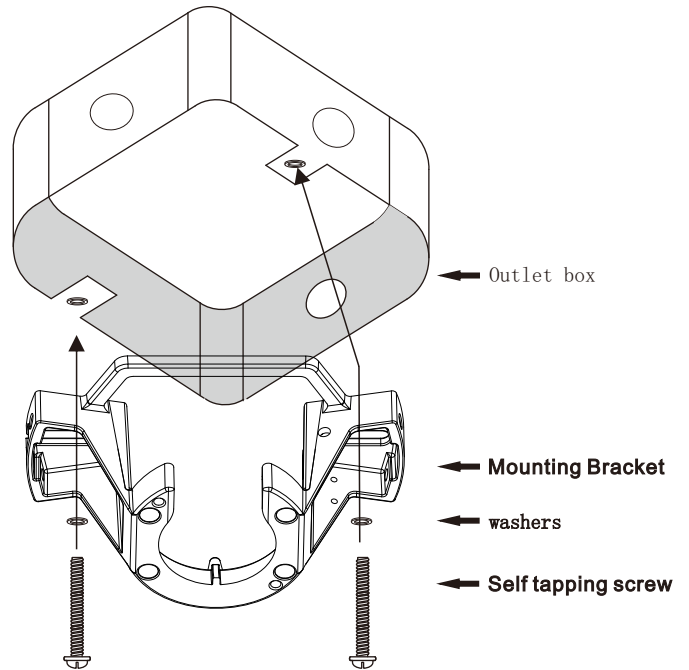

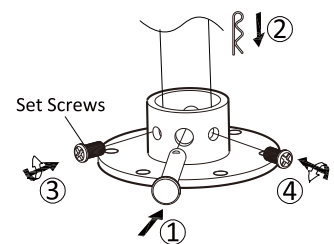
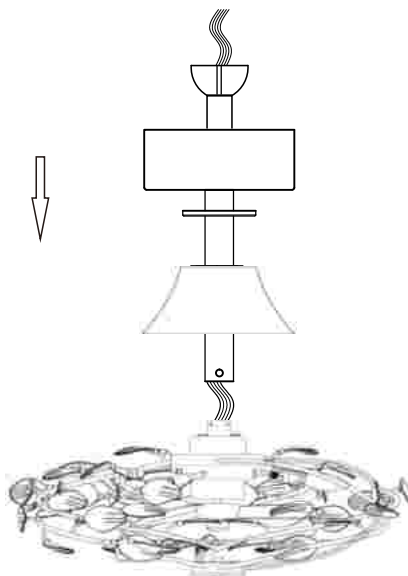

Phillips  
screwdriver

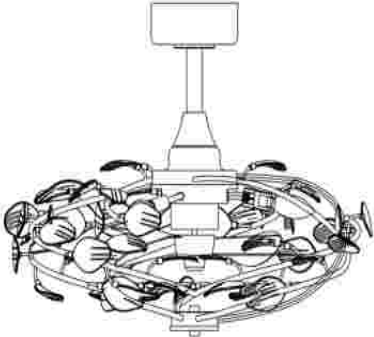

Phillips  
screwdriver

WARNING: SHUT POWER OFF AT FUSE OR CIRCUIT BREAKER

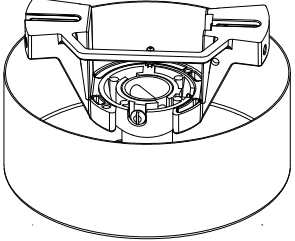
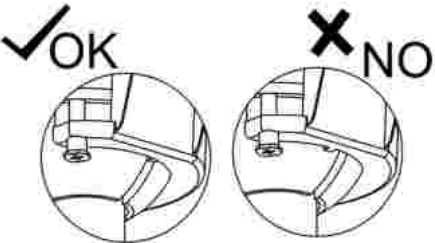
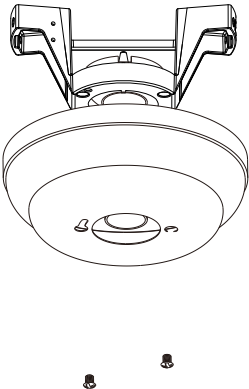
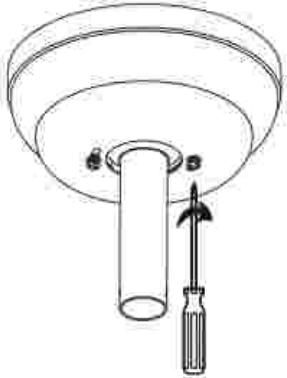
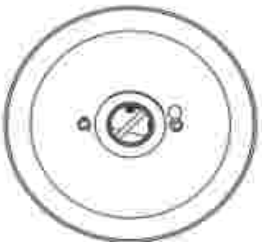
		
		 <p>⊕ Phillips screwdriver</p>
 <p>Finish</p>		

WARNING: SHUT POWER OFF AT FUSE OR CIRCUIT BREAKER

FROM POWER SOURCE  
AC 120 VOLT 60Hz 3.  
5AMPS.

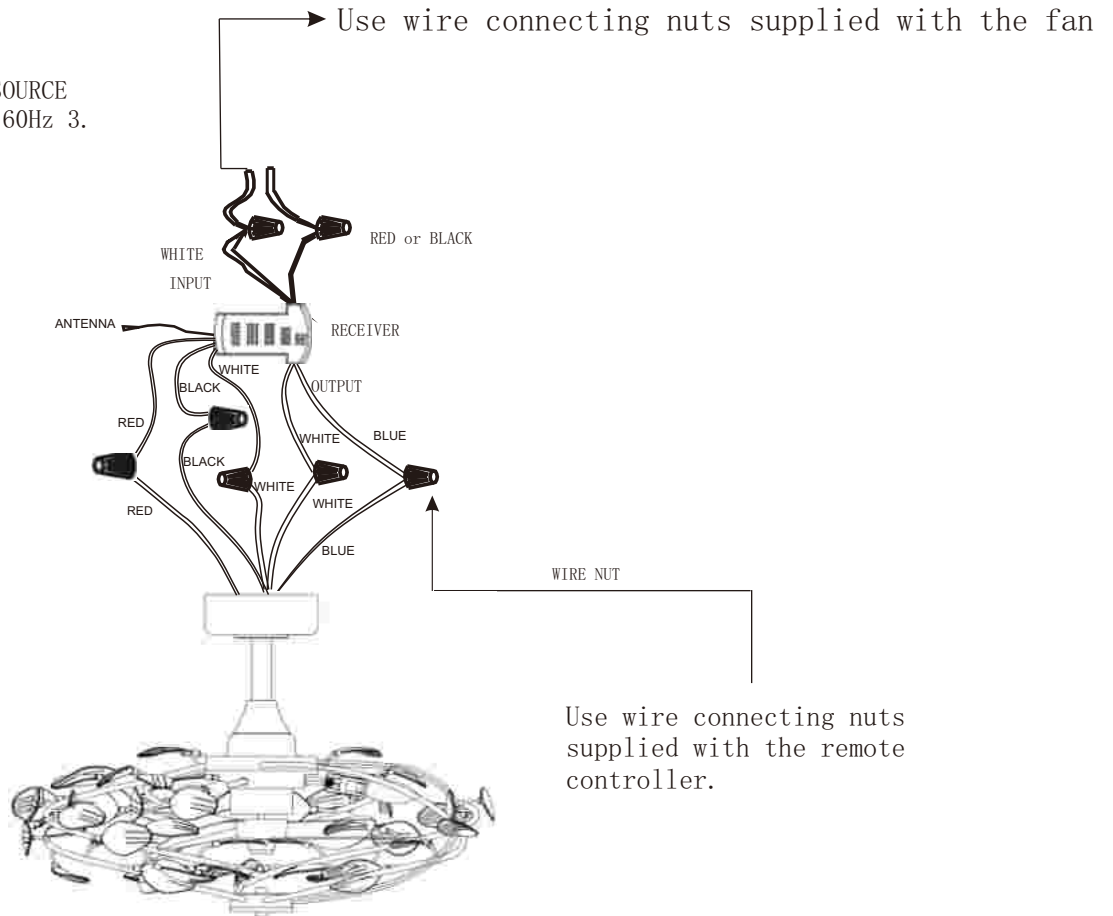

RECEIVER  
(FIG. 4)



CANOPY

ANTENNA PUT AT OUTSIDE  
OF CANOPY BOX CAN GET  
MORE OPERATION  
DISTANCE



#### Install remote control

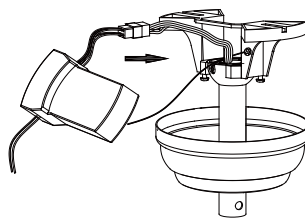

1. Carefully push the canopy to the bottom of the mounting bracket, make two sliding holes aligned to the two prominent screws on the mounting bracket, and then turn clockwise until tight.
2. Push the canopy ring to the bottom of the canopy, slide the inner holes aligned to the two prominent screws on the mounting bracket again, and turn the canopy ring clockwise until tight.

#### remote control <ONLY>

#### Preparing for mounting

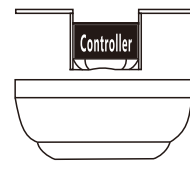

- 1: Remove the mounting bracket from the canopy by loosening the two canopy screws located in the L shaped slots.
- 2: Remove and save the two canopy screws in the round holes. This will enable you to remove the mounting bracket

LIGHT MUST BE KEPT AT THE ON POSITION

FAN MUST BE KEPT AT THE HIGH SPEED

WARNING: SHUT POWER OFF AT FUSE OR CIRCUIT BREAKER

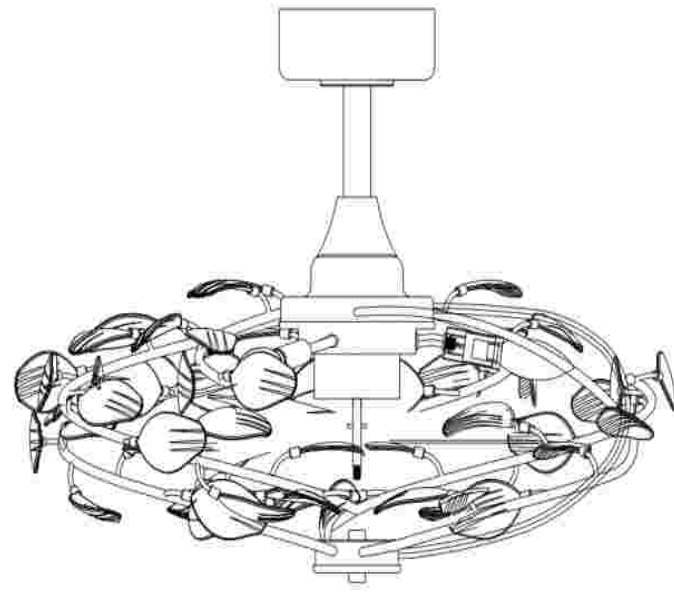

 Phillips  
screwdriver

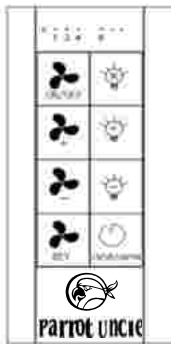
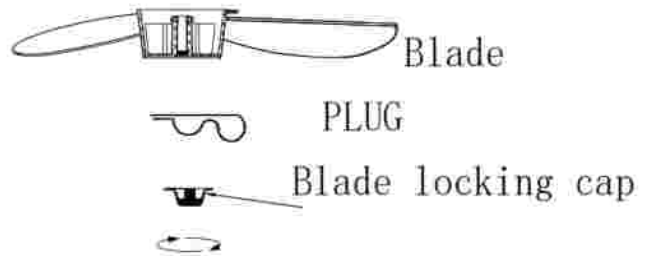
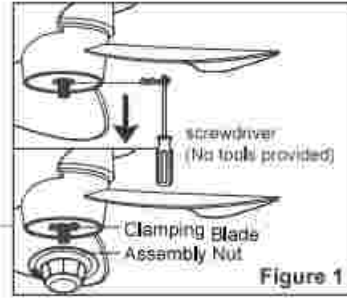

### OPERATING YOUR FAN

Turn on the power and check the operation of the fan. The fan remote controls the fan speed as follows:

1=low speed      2=medium low speed      3=medium speed

4=medium high speed      5= high speed      6= Extra high speed

The appropriate speed settings for warm or cool weather depends on factors such as the room size, ceiling height, and number of fans.

The remote control (XX) controls the direction of the blades: forward or reverse.

 NOTE: Wait for the fan to stop before reversing the direction of the blade rotation

A. warm weather-(Forward).

This allows you to set your air conditioner on a higher setting without affecting your comfort.

B. Cool weather-(Reverse)

This allows Reverse you to set heating unit on a lower setting without affecting your comfort.

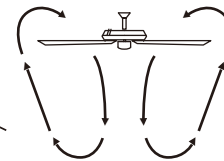

A. Warm Weather  
(SUMMER TIME)

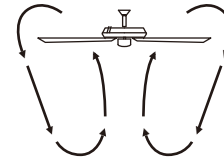

B. Cool Weather  
(WINTER TIME)

WARNING: SHUT POWER OFF AT FUSE OR CIRCUIT BREAKER

## OPERATION FOR REMOTE

1. Learning code matching mode is used between REMOTE CONTROL

### » .OPERATING TRANSMITTER:

- Install CR2032-3Vx1volt battery(included).(To prevent damage to transmitter, remove the battery if not used for along time).
- Store the transmitter away from excessive heat or humidity.
- Operating the buttons on the panel of the transmitter.

¶ . and receiver. Turn on the supply power within 5 seconds and press the REMOTE CONTROL "FAN ON/OFF" button for 3 seconds, it can load normally after hearing a long sound "bee", which means learning successfully and it can works normally.(PS: Learning mode is not accepted after turn "ON" the supply power for 5 seconds)

### 2.INSTALLING RECEIVER IN CEILING FAN

#### A.Safety precautions:

**WARNING: HIGH VOLTAGE!** Disconnect power by removing fuse or switching off circuit breaker. Do not use with solid state fans.

Electrical wire must meet all local and national electrical code requirements.

Supply for fan must be 120 volt, 60Hz. Maximum fan motor amps: 1.0,Maximum light watts: 20 incandescent or ballast and LED.

Otherwise power can cause serious injury or death.

#### B.Installing receiver in fan:

- Remove power from the circuit.
- Remove ceiling fan canopy from the mounting bracket.
- Disconnect existing wiring between ceiling fan and Supply in electrical junction box.
- Make connections as follows, using the wire nuts supplied:

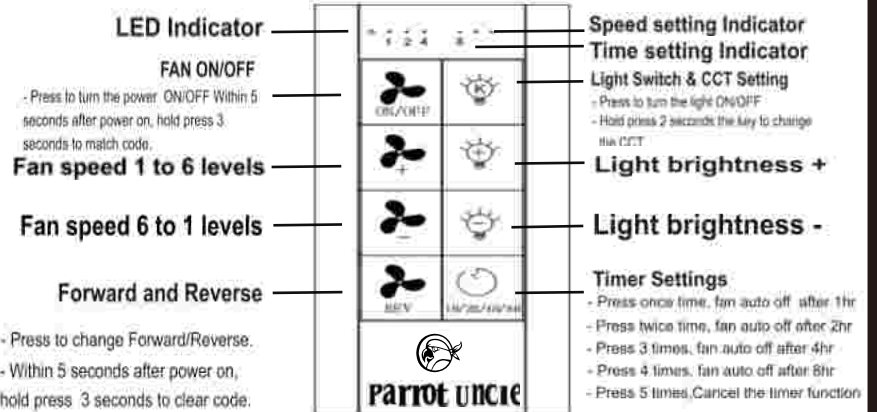

### Wiring diagram

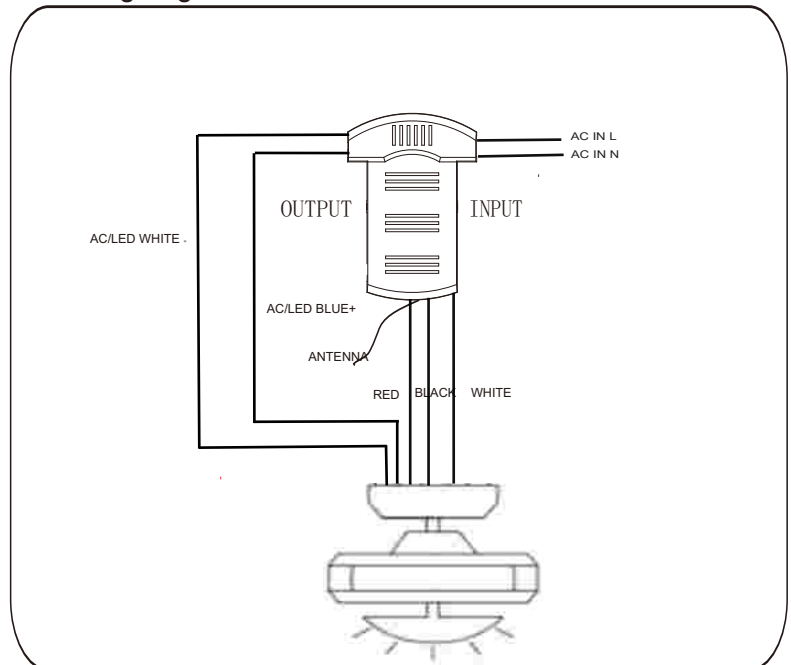

FROM POWER SOURCE  
AC 110- 120 VOLT 60Hz  
3.5AMPS.

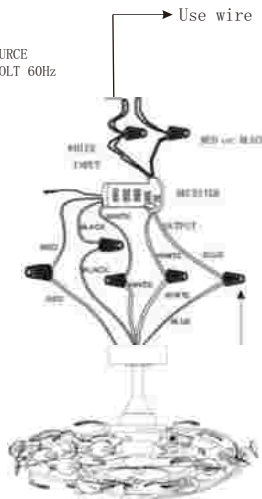

ANTENNA PUT AT OUTSIDE OF CANOPY BOX CAN GET WIRE OBSTRUCTION DISTANCE

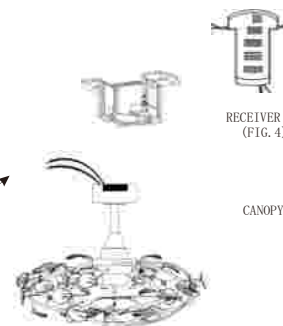

FAN MUST BE KEPT AT THE HIGH SPEED

WARNING: SHUT POWER OFF AT FUSE OR CIRCUIT BREAKER

If other fans or supply wires are different color, have this unit installed by qualified licensed electrician.

- e. Push all connected wires up into junction box.
- f. Lay the black antenna wire on top of the receiver, and put the receiver into the mounting bracket.
- g. Reinstall the canopy on the mounting bracket.
- h. Restore power.

### 3. OPERATING TRANSMITTER:

- A. Install CR2032-3Vx1volt battery(included).(To prevent damage to transmitter, remove the battery if not used for along time).
- B. Store the transmitter away from excessive heat or humidity.
- C. Operating the buttons on the panel of the transmitter.

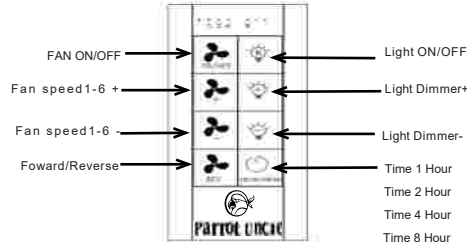

### FCC Statement:

1. This device complies with Part 15 of the FCC Rules.Operation is subject to the following two conditions:
  - (1) This device may not cause harmful interference.
  - (2) This device must accept any interference received, including interference that may cause undesired operation.
- 2.Changes or modifications not expressly approved by the party responsible for compliance could void the user's authority to operate the equipment.

NOTE:This equipment has been tested and found to comply with the limits for a Class B digital, pursuant to Part 15 or the FCC Rules.These limits are designed to provide reasonable protection against harmful interference in a residential installation.This equipment generates, uses and can radiate radio frequency energy and, if not installed and used in accordance with the instructions, may casue harmful interference to radio communications, However, there is no guarantee that interference will not occur in a particular installation.If the equipment does cause harmful interference to radio or television reception, which can be determined by turning the equipment off and on, the user is encouraged to try to correct the interference by one or more of the following measures:

- Reorient or relocate the receiving antenna.
- Increase the separation between the equipment and receiver.
- Connect the equipment into an outlet on a circuit different from that to which the receiver is connected.
- Consult the dealer or an experienced radio/ TV technician for help.

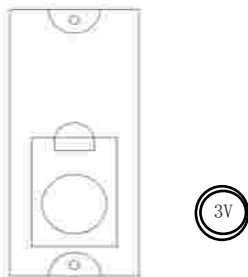

YOUR REMOTE NOW HAS FULL CONTROL OF THE FAN AND LIGHT .

OPERATION DISTANCE 20 FEET

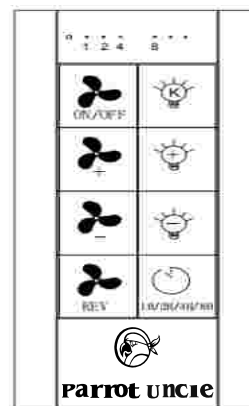

TRANSMITTER

Optional Wall Mounting for Transmitter Holder  
Place in accessible area of your home, and screw the transmitter holder into wall using the two screws provided,slide hand unit into holder.

### 4.TROUBLE SHOOTING GUIDE1.Fails to operate

- a. Power to receiver ?
  - b.Receiver wired correctly ?
  - c.Fan manual speed control in highest position ?d.Light kit switch turned on ?
  - e.Good battery in the transmitter ?
- 2.Won' t operate at distance  
If transmitter operates fan/light kit when up close,but not at 20 feet away.

### NOTICE!

Your ceiling fan and light kit assembly must meet the following requirements:

- 1.Do not use with solid state fans.
- 2.Electrical rating: 120v 60Hz 3.5A  
MAX. Motor amps: 1.0  
MAX.Light watts: 180-(incandescent, or ballast non-dimmer, or LED)

### WARNING

TO REDUCE THE RISK OF SHOCK, THIS FAN MUST BE INSTALLED WITHAWALL CONTROL/SWITCH.

WARNING: SHUT POWER OFF AT FUSE OR CIRCUIT BREAKER

## ⚠ WARNING

- **INGESTION HAZARD:** This product contains a button cell or coin battery.
- **DEATH** or serious injury can occur if ingested.
- A swallowed button cell or coin battery can cause **Internal Chemical Burns** in as little as 2 hours.
- **KEEP** new and used batteries **OUT OF REACH OF CHILDREN**
- **Seek immediate medical attention** if a battery is suspected to be swallowed or inserted inside any part of the body.



Remove and immediately recycle or dispose of used batteries according to local regulations and keep away from children. Do **NOT** dispose of batteries in household trash or incinerate.

Even used batteries may cause severe injury or death.

Call a local poison control center for treatment information.

Compatible battery type is CR2032, 3 V

Ensure the batteries are installed correctly with regard to polarity (+ and -).

Do not mix old and new batteries, different brands or types of batteries, such as alkaline, carbon-zinc, or rechargeable batteries.

Non-rechargeable batteries are not to be recharged. Exhausted batteries are to be removed from the product.

Do not force discharge, recharge, disassemble, heat above (manufacturer's specified temperature rating) or incinerate. Doing so may result in injury due to venting, leakage or explosion resulting in chemical burns.

Remove and immediately recycle or dispose of batteries from equipment not used for an extended period of time according to local regulations.

Always completely secure the battery compartment. If the battery compartment does not close securely, stop using the product, remove the batteries, and keep them away from children.

⚠ **WARNING INGESTION HAZARD:** This product contains a button cell or coin battery.

## ⚠ ADVERTENCIA

- **PELIGRO DE INGESTIÓN:** Este producto contiene una batería (pila) en forma de botón o moneda
- Si se ingiere, puede causar la **MUERTE** o lesiones graves
- La ingestión de la batería en forma de botón o moneda puede causar **Quemaduras Químicas Internas** en tan solo 2 horas.
- **MANTENGA** las baterías nuevas y usadas **FUERA DEL ALCANCE DE LOS NIÑOS**
- **Busque atención médica inmediata** si se sospecha que una batería ha sido ingerida o introducida en cualquier parte del cuerpo.



Remueva las baterías (pilas) usadas y recíclelas o deséchelas inmediatamente de acuerdo con los reglamentos locales y manténgalas fuera del alcance de los niños. **NO** tire las baterías al recipiente de basura doméstica ni las incinere.

Incluso las baterías usadas pueden causar lesiones graves o la muerte.

Llame a un centro de toxicología local para obtener información sobre el tratamiento.

Tipo de batería compatible CR2032, 3 V

Asegúrese que las pilas estén bien colocadas respecto a la polaridad (+ y -).

No mezcle baterías viejas y nuevas, de diferentes marcas o tipos de baterías, tal como las baterías alcalinas, de carbono-zinc, o recargables.

Las baterías no-recargables no se deben recargar. Las baterías gastadas se deben sacar del producto.

No fuerce la descarga, no recargue, no desensamble, no caliente por encima de la capacidad de temperatura especificada por el fabricante ni incinere. Hacerlo puede causar lesiones debido al desfogue, fuga o explosión que podrían causar quemaduras químicas.

Remueva y recicle o deseche inmediatamente las baterías de equipos que no se hayan utilizado durante un período prolongado de tiempo, de acuerdo con los reglamentos locales.

Siempre cierre por completo el compartimiento de las baterías. Si el compartimiento de las baterías no está bien cerrado, deje de usar el producto, extraiga las baterías y manténgalas fuera del alcance de los niños.

⚠ **ADVERTENCIA PELIGRO DE INGESTIÓN:** Este producto contiene una batería (pila) en forma de botón o moneda.

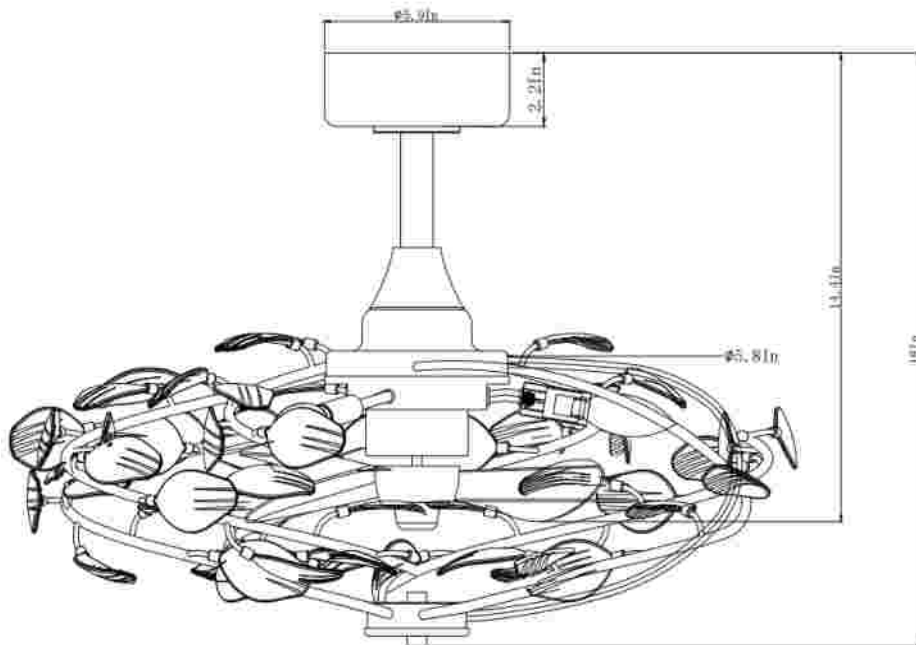

## TROUBLESHOOTING GUIDE

### Table of Contents

1. Fan / Remote is not working
2. Fan is noisy
3. Fan Wobbles

*Please refer to the instruction sheet for detailed directions and descriptions of installation steps and requirements.*

### 1. FAN / REMOTE IS NOT WORKING

Ensure the remote is within the 20 foot range of the receiver

To reset the remote control: 1) Turn off power to fan using the wall switch or circuit breaker. 2) Remove batteries from remote. 3) Wait 10 seconds. 4) Replace batteries and turn power on

Check batteries to insure they are good and oriented correctly

Check the main and branch circuit fuses or breakers

If using a Variable Speed Wall Switch, ensure it is specifically designed for use with a ceiling fan.

Check the line wire connections to the fan and the switch wire connections in the switch housing per the instructions

If fan still does not work, please contact Customer Service [Support@ parrotuncle.com](mailto:Support@parrotuncle.com)

### 2. THE FAN IS NOISY

Make sure all motor housing screws are tightened

Make sure the screws that attach fan blade to motor are tight

Make sure the wire nut connectors are not rattling against each other or the interior wall of the switch housing

Allow 24-hour break in period. Most noises associated with the new fan may disappear during this time

If using a ceiling light kit, make sure the glassware is secured tightly

Make sure there is a short distance/gap from the ceiling to the top of the canopy. The canopy should not touch the ceiling!

Make sure your ceiling box is secure and that the rubber isolator pads are used between the mounting bracket and outlet box

## 3. THE FAN WOBBLES

Verify all blades and blade bracket screws are secure (most fan wobble problems are caused by loose parts). Once fan is properly installed, run the ceiling fan for 10 minutes to let the fan self-adjust.

If wobble occurs atier running the fan for 10 minutes, verify blade level using the following process:

a) select a point on the ceiling above the tip of one of the blades. Then select the fan blade and measure from the center of the selected blade to point on the ceiling. Rotate the fan until the next blade is positioned and repeat the measurement using the same point from the ceiling for every blade. Measurements should be within 1/8 inch.

b) If all deviation are less than 1/8 inch and the fan contnues to wobble, please contact Customer Service **Support@ parr otuncle.com** to order a complimentary Blade Balancing Kit

-If all deviationsare less than 1/8 inch and the fan continues to wobble, pleasecontact Customer Service **Support@ parrotuncle .com** to order a complimentaryBlade Balancing Kit

WARNING: SHUT POWER OFF AT FUSE OR CIRCUIT BREAKER

## AFTER INSTALLATION

### WOBBLE”

The fan blades have been adjusted in the factory to minimize any wobble

NOTE:CEILING FANS TEND TO MOVE DURING OPERATION DUE TO THE FACT THAT THEY ARE MOUNTED ON A RUBBER CROMMET. IF THE FAN WAS MOUNTED RIGIDLY TO THE CEILING, IT WOULD CAUSE EXCESS VIBRATION. MOVEMENT OF A FEW CENTIMENTERS IS QUITE ACCEPTABLE AND DOES NOT SUGGEST ANY PROBLEM

TO REDUCE THE FAN WOBBLE: PLEASE CHECK THAT ALL SCREWS WHICH SECURED THE MOUNTING BRACKET AND DOWNROD ARE SECURE.

BALANCING A WOBBLING CEILING FAN:

For your convenience, a Balancing Kit is included; please follow this procedure when balancing the fan:

- 1.Check that all blade and blade arm screws are secure.
- 2.Most fan wobbling problems are caused when blade levels are unequal. Check this level by selecting a point on the ceiling above the tip of one of the blades. Measure this distance.Rotate the fan until the next blade is positioned for measurement. Repeat for each blade. The distance deviation should be equal within 1/8” (0.32cm).

3.Use the enclosed Blade Balancing Kit if the blade wobble is still noticeable.

4.If the blade wobble is still noticeable, interchanging two adjacent (side by side) blades can redistribute the weight and possibly result in smoother

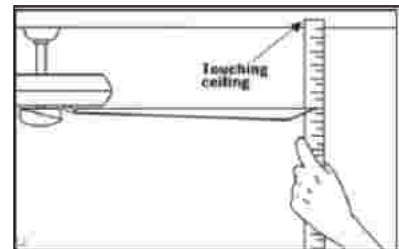

operation. WARNING: TO REDUCE THE RISK OF PERSONAL INJURY, DO NOT BEND THE BLADE ARM WHILE INSTALLING, BALANCING THE BLADES, OR CLEANING THE FAN. DO NOT INSERT FOREIGN OBJECTS BETWEEN ROTATING FAN BLADES.

### NOISE

When it is quiet(especially at night) you may hear occasional small noises. This is normal. Please allow a 24-hour “breaking-in” period, most noises associated with a new fan disappear during the time.

### CARE AND CLEANING

- 1.Periodic cleaning of your ceiling fan is the only maintenance required. Use a soft brush or lint free cloth to avoid scratching the paint finish. Please make sure to turn off electricity power before you clean your fan
- 2.Do not use water when cleaning your ceiling fan. It could damage the motor or the blades and create the possibility of an electrical shock.
- 3.Motor has permanently lubricated ball bearing. No need to oil

NOTE: MAKE SURE THE POWER IS OFF AT THE ELECTRICAL PANEL BOX BEFORE YOU ATTEMPT ANY CLEANING OR REPAIRS.

**Parrot  Uncle**