

# **REXING**

**/// Dash Cam**

## **V3**

# User Manual

The information in this manual is subject to change without notice.

## About This Manual

This device provides high-quality digital recording using Rexing's high standards of design, construction and technological expertise. This user manual describes the device's functions and features in detail. Please read this manual before using the device to ensure safe and proper use. Note that all descriptions included here are based on the device's default settings.

- Images and screenshots may differ in appearance from the actual product. Content may differ from the final product or from software provided by service providers and is subject to change without prior notice.
- For the latest version of this manual, refer to the Rexing website at [www.rexingusa.com](http://www.rexingusa.com).
- Available features and additional services may vary by device and software.
- Applications and their functions may vary by country, region, or hardware specifications.
- Rexing is not liable for performance issues caused by applications from any provider other than Rexing.
- Rexing is not liable for performance issues or incompatibilities caused by failure to install the device as stated in this manual. Attempting to customize the installation may cause the device or applications to work improperly which may result in device malfunctions and data corruption or loss. These actions are violations of your Rexing agreement and will void your warranty.

- Default applications that come with the device are subject to updates and possible discontinuation of support without prior notice. If you have questions about an application provided with the device, contact an authorized Rexing Service Center.



[/rexingusa](https://www.facebook.com/rexingusa)



[@rexingdashcam](https://www.instagram.com/rexingdashcam)



[www.rexingusa.com/support/registration/](http://www.rexingusa.com/support/registration/)



# 1. What's in the box?

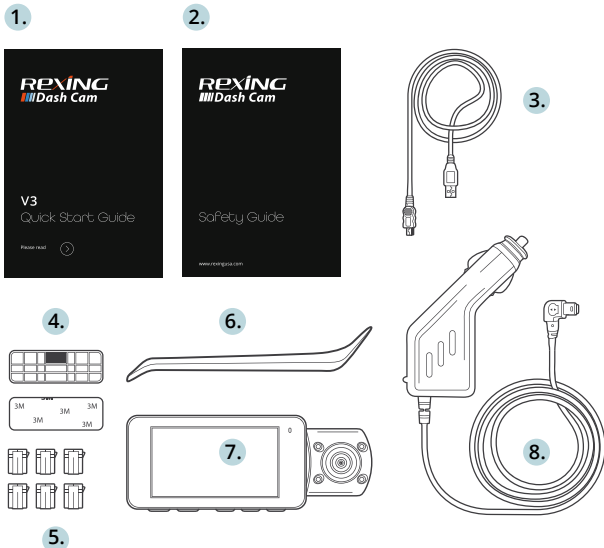

1. Quick Start Guide
2. Safety Guide
3. USB Cable
4. 3M Adhesive Mount
5. Cable Adhesive Spacer
6. Cable Management Tool
7. REXING V3 Dashboard Camera
8. Car Power Connector (12ft)

The items supplied with the device and any available accessories may vary depending on your region. Appearances and specifications are subject to change without prior notice. Availability of accessories is subject to change.

All supplied items are designed for use only with this device and may not be compatible with other devices. Malfunctions resulting from the use of unapproved accessories are not covered by the warranty service.

For more information about available accessories, refer to [www.rexingusa.com](http://www.rexingusa.com).

## 2. Camera Overview

### Device Layout

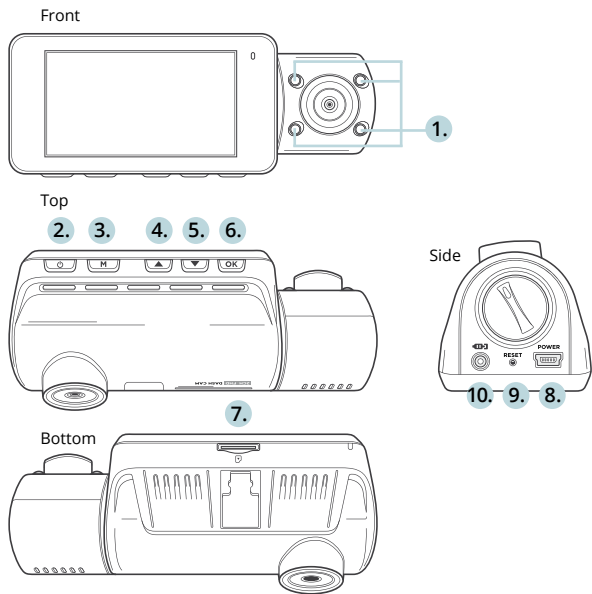















1. 4 IR Lights
2. Power Button / Screen Toggle Button
3. Menu Button / Mode Button
4. Up Navigation Button / Front and Rear Switch Button
5. Down Navigation Button / Mic Button
6. OK (Confirm) Button / Emergency Lock Button / Record Button
7. Micro SD Card Slot
8. Power / USB Charging Port
9. Reset Button
10. Rear Camera Port (currently not support)

### Buttons

Button	Function
	<b>Press:</b> Toggle display on or off <b>Hold:</b> Turn the device on or off manually
<b>OK</b>	<b>Menus:</b> Confirm a selection <b>Video Mode:</b> Manually lock current recording <b>Photo Mode:</b> Take photo <b>Playback Mode:</b> Start / stop playback <b>Video Mode:</b> Start/stop recording:
<b>M</b>	<b>Press:</b> Enter menu, cycle through menus or exit current menu <b>Hold:</b> Change mode
	<b>Menus:</b> Move selection up <b>Hold (Video or Photo Mode):</b> Enable Wi-Fi feature <b>Playback Mode:</b> Decrease or reverse playback speed / Cycle left through recordings <b>Press (Video or Photo Mode):</b> Change front / rear camera views
	<b>Menus:</b> Move selection down <b>Video Mode:</b> Toggle audio recording <b>Playback Mode:</b> Increase playback speed / Cycle right through recordings
<b>RESET</b>	Press and hold for 4 seconds to reset the device in the event that it operates erratically, hangs up, or freezes
Indicator	Flashing Red – Recording

## Status Icons

Icon	Indication
<b>1080P + 1080P</b>	Video Resolution
	Currently Recording (Blinking)
	Wide Dynamic Range Enabled
	Connected to Power Source
	Audio Recording Enabled
	Audio Recording Disabled
	Video Recording Mode
	Playback Mode
	Photo Mode
	Loop Recording

	Memory Card (Inserted)
<b>EV</b> <b>0.0</b>	Exposure
	GPS Signal Acquired
	GPS Searching for Signal
	Current Recording Locked
	IT Lights Auto
	G-Sensor Level

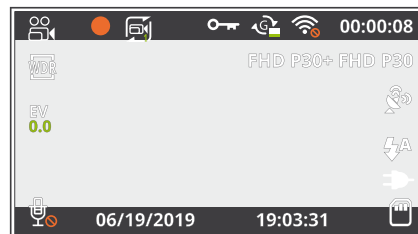

## 3. Getting Started

### Installation

Video guide can be found at [video.rexingusa.com](http://video.rexingusa.com).

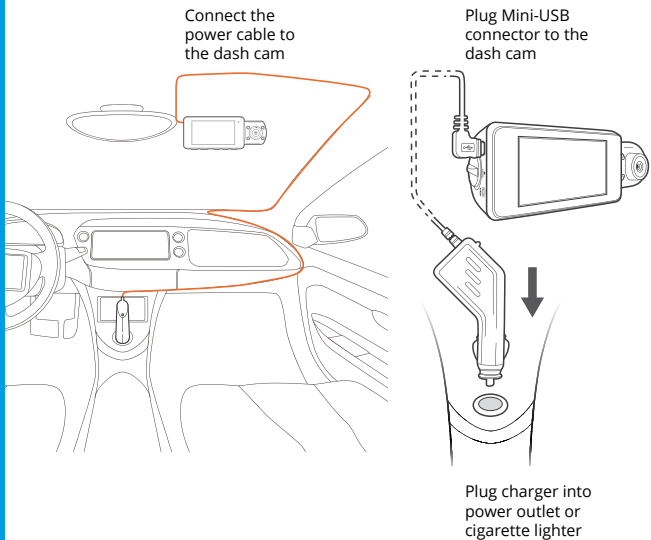

### Step 1: Mount the Front Camera to the Windshield

Make sure that you mount the front camera in a safe, appropriate location where it won't obstruct the driver's view. Clean your windshield before applying the mount. Wait **at least 20 minutes** after applying the mount to the windshield before attaching the camera.

### Step 2: Inserting the Memory Card

The V3 accepts Micro SD memory cards (class 10 or higher) with a maximum capacity of 256GB.

Depending on the memory card manufacturer and type, some cards may not be compatible with your device. **Using an incompatible card may damage the device or the memory card or corrupt the data stored on it.**

We highly recommend using Micro SD cards that are specifically designated for use with dash cams. You can find our recommendations on our website: [www.rexingusa.com/memory-card/](http://www.rexingusa.com/memory-card/).

*Note: Before inserting or removing a memory card, first ensure you've powered down the device.*

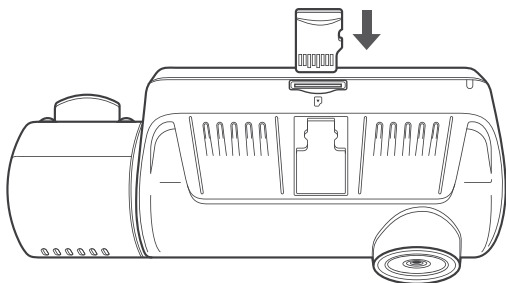

### Inserting a memory card

1. If the device is powered on, press and hold the **POWER** button to power down.
2. Insert the card in the orientation shown.
3. Push the card into the slot, listening for a click sound signaling the card is securely inserted.

### Removing the Memory Card

Before removing a memory card from your V3, you must first dismount it for safe removal.

**With the device powered down**, press down the memory card until you hear a click. Gently remove your finger (or other pressing object) to allow the spring release to push the memory card out of the slot.

**Do not remove the memory card while the device is transferring or accessing information.** Doing so can result in data loss or corruption or damage to the memory card or device. Rexing is not responsible for losses that result from the use of damaged memory cards, including the loss of data.

## Step 3: Formatting a Memory Card

### Step 3.1: Powering the Camera

**You must always connect the V3 to a power source while operating the camera.** Connect the camera to your vehicle via the included car charger cable. Connect the larger end of the car charger cable to your car's cigarette lighter (12V DC power outlet), and connect the other Mini-USB end to the Mini-USB port on the device.

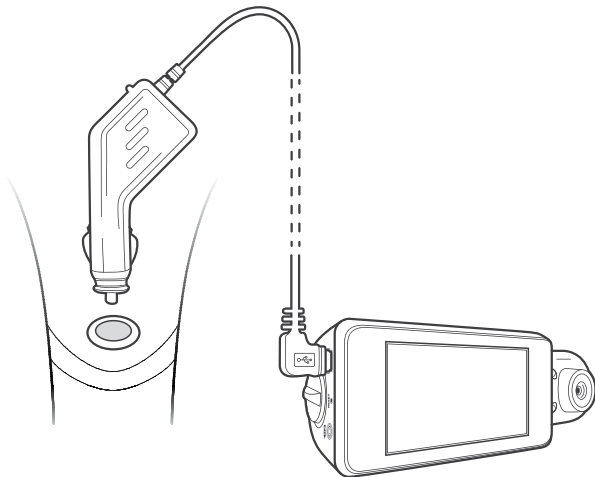

**Connecting the charger improperly may cause serious damage to the device. Any damage caused by misuse is not covered by the warranty. Use only Rexing-approved chargers. Using unapproved chargers or cables can damage the device.**



If the device receives an unstable power supply, the screen may not function properly. If the device is not operating properly using a Rexing-approved charger, please contact Customer Care ([care@rexingusa.com](mailto:care@rexingusa.com)).

### Step 3.2: Formatting the Memory Card

Before formatting your memory card, always remember to make backup copies of all important data stored on the device. The manufacturer's warranty does not cover loss of data resulting from user actions.

For best results, format the memory card using the Format function on your camera.

It's recommended that you format your memory card after

transferring files to your computer or at least once a month. Using your camera to format a memory card:

1. Upon turning on the camera, press the **OK** button to stop recording.
2. Press the **MENU** button twice to enter the Setup Menu.
3. Use the **UP** and **DOWN** navigation buttons to navigate to the "Format" option.
4. Press **OK** to confirm your selection.
5. You will be notified that all data will be deleted. Scroll down to "OK" and press the **OK** button to confirm.
6. If you followed the instructions above, you should see a blue box asking you to please wait while the card is being formatted. Formatting should only take a moment, and you will be taken back to the Setup Menu once formatting is complete.
7. At this point, disconnect from the power source. The camera will shut down automatically after 3 seconds. The next time the camera is connected to power, the camera should start up and begin recording automatically.

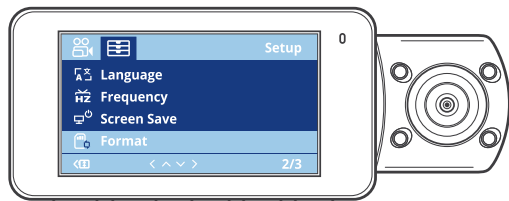

Press the Menu button twice

Press the OK button to confirm formatting the card

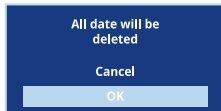

### Step 4: Connect the car charger to the car's 12V DC outlet

Run the cable down from your camera to the 12V cigarette lighter port of your vehicle. Be sure to connect only Rexing-approved chargers designed and supplied specifically for use with your device. Using an incompatible charger can cause serious personal injury or damage to your device.

## Step 5: Turning the Device On or Off

Press and hold the **POWER** button for a few seconds to turn on the device. A welcome message will be displayed onscreen.

To turn off the device, again press and hold the **POWER** button for a few seconds. A goodbye message will be displayed onscreen.

**The V3 will switch on or off automatically if you keep it connected using the car charger. The camera will automatically start recording when it is powered on. After power is disconnected, the device will shut down after 3 seconds.**

*Note: If your car cigarette lighter provides constant power, the unit may not turn on or off automatically with the car.*

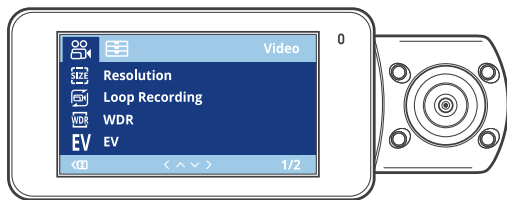

Press and hold the **POWER** button to turn the device on manually

## 4. Basic Operation

### 4.1 Automatic Recording

The camera automatically starts recording when it is powered on

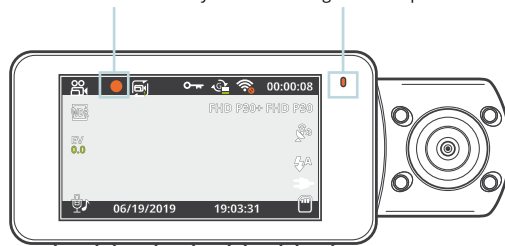

The device will automatically turn on and begin recording once it receives power, such as when you start your car. The indicator and the red dot icon on screen will flash while recording.

### Display Control

To switch between cameraviews on the LCD display, hold the **UP** button. Press the **POWER** button will turn on or off the LCD screen, your display setting won't affect the way recordings are captured.

### Locking Videos

While recording, you can hold the **OK** button to manually lock the current video clip. This will ensure that Loop Recording won't overwrite the clip when the memory card is full. You can

also lock videos after recording by using the Protect function in the Playback Menu. Locked videos can be found on the memory card under “\CARD\MOVIE\RO”.

### Automatic Shutdown

Once power is disconnected, the dash cam will shut down within 3 seconds.

### Wi-Fi Feature

In Video Recording Mode, while recording is stopped, hold the **UP** button to enable Wi-Fi feature. For detailed instructions on how to use Wi-Fi feature, see page 25 – Wi-Fi Connect.

## 4.2 Playback

Video recordings from the front and back cameras will be stored in chronological order on the memory card for easy navigation and playback.

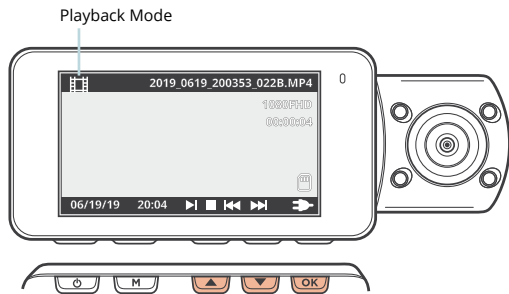

Control playback with OK, UP and DOWN navigation buttons

### 4.2.1 Camera Playback Mode

#### To play recordings on your device:

1. Switch to Playback Mode by holding the **MENU** button.
2. Use the **UP** and **DOWN** buttons to browse your videos.
3. Press **OK** to play a selected recording.
4. During playback, press **OK** to stop playback.
5. **FAST FORWARD:** During playback, press the **DOWN** button one or more times to increase playback speed (2X / 4X / 8X).
6. **FAST REWIND:** During playback, press the **UP** button one or more times to decrease or reverse playback speed (-2X / -4X / -8X).

#### To delete a selected recording:

1. In Playback Mode, use the **UP** and **DOWN** buttons to browse your videos.
2. Once you find the recording you want to delete, press **MENU** to view options.
3. Press the **DOWN** button to scroll down to “Delete”.
4. Press **OK** once to view options to “Delete Current” recording or “Delete All” recordings.
5. With “Delete Current” selected, press **OK**.
6. When prompted with “Erase This?” press the **DOWN** button to scroll down to “OK” and press **OK** to delete the selected recording.

#### To delete all recordings:

1. In Playback Mode, press **MENU** to view the Playback Menu.
2. Press the **DOWN** button to scroll down to “Delete”.
3. Press **OK** once to view options to “Delete Current” recording or “Delete All” recordings.
4. With “Delete All” selected, press **OK**.

- When prompted with "Erase All Recordings?" press the **DOWN** button to scroll down to "OK" and press **OK** to delete all recordings.

## 4.2.2 Computer Playback

*Recommended Media Players: QuickTime Media Player / VLC / Windows Media Player*

### Using an SD card adapter

Insert your Micro SD card into an SD card adapter, then insert the SD card adapter into your computer or a card reader to access your card storage. Your videos will be stored under "\CARDV\MOVIE".

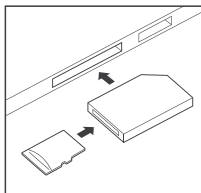

### Using a USB cable

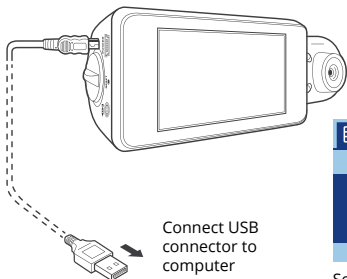

Connect USB connector to computer

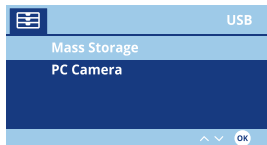

Select Mass Storage

Connect your camera to your computer using the provided USB cable and select "Mass Storage" to access your card storage. Your videos will be stored under "\CARDV\MOVIE".

### Locked files

Locked videos can be found on the memory card under "\CARDV\MOVIE\RO".

## 4.2.3 GPS Playback

You can play back your recordings in a specialized application that allows you to view speed and location information alongside your footage.

### System Requirements

Operating System: Windows 7, 8, or 10, MAC OS X  
Display Resolution: 1280x720

### Installing the application:

- Locate your dash cam at [support.rexingusa.com](http://support.rexingusa.com) to access the GPS Playback software.
- Download the zip folder containing the software installer.
- Unzip the folder to access the installer file contained within.
- Open the installer and follow the instructions to install the GPS Playback software to your computer.
- Once installed, you may launch the application.

Please go to [rexingusa.com/support/videos/](http://rexingusa.com/support/videos/) for a tutorial video.

## Opening a GPS video file:

1. Once you've opened the application, navigate to the top menu bar and click "File > Open" to browse through your files.
2. Navigate to the video file you want to add to the playback queue, select it and click "Open" to load it into the application. You may also select multiple videos at once.
3. After a brief loading period, the (first) video should begin playing automatically, displaying speed and location information in real time along the right-side panels.

## Playback

Beneath the video is a playback bar with a handle that you can drag to skip ahead to any time point in the video. Beneath that, there's a volume control slider, as well as previous, rewind, pause/play, fast forward, next, and stop buttons.

## Additional Controls

**Snip:** Save the current frame of video as an image (PNG).

**Full Screen:** View the video in full screen (double-click the video to exit).

## Settings

In the settings menu, you may change your language from English to Chinese, Japanese, or Vietnamese, etc. You may also change your unit of speed measurement from MPH to KM/H. Additionally, you have the option to change the map application used from Google Maps to Baidu Maps.

## 4.3 Wi-Fi Connect

Use your mobile device to download the "Rexing Connect" app from the App Store or Google Play.

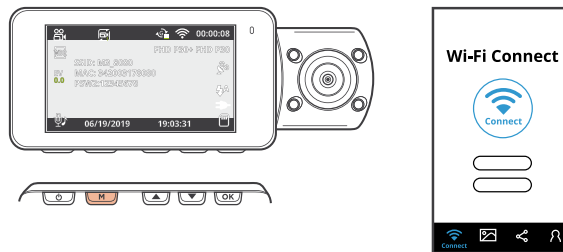

After you've done this, follow the instructions below:

1. **Dash cam:** In Video Recording Mode, access the Wi-Fi function by holding **UP** (this can also be done by enabling the Wi-Fi feature in the Setup Menu).
2. **Mobile device:** Navigate to your device's Wi-Fi settings and connect to the Wi-Fi name that's shown on the dash cam after "SSID:". When prompted for a password, enter the password shown on the dash cam after "PWA2:".
3. **Mobile device:** Once connected to the dash cam Wi-Fi, open the Rexing Connect app. From there, press the "Connect" button to connect to the dash cam interface.
4. **Dash cam:** Once connected, the screen should switch to the camera view and display a "Wi-Fi Connected" message.

Using the Rexing Connect app, you can view a live preview of the dash cam screen, start / stop recording, as well as view and save

your captures with your mobile device.

To exit Wi-Fi feature, hold the **UP** button to return to Video Recording Mode.

For further instruction regarding the Wi-Fi Connect feature, please visit [www.rexingusa.com/wifi-connect/](http://www.rexingusa.com/wifi-connect/).

## 5. Mode setup

### Video Mode Settings

These settings affect your video recordings. In Video Recording Mode, press **OK** to stop recording, then press **MENU** once to open the Video Menu.

#### Resolution

Default setting: FHD P30 + FHD P30 (1080p 30fps front and rear)

Set the video recording resolution.



Approximate recording time (dual-channel)

Memory Card Size	FHD P30 + FHD P30 Resolution	HD P30 + HD P30 Resolution
16GB	1.75 hours	2.5 hours
32GB	3.5 hours	5 hours
64GB	7 hours	10 hours

128GB	14 hours	20 hours
256GB	28 hours	40 hours

*Note: Choosing a single-channel resolution such as UHD, QHD, etc. will disable recording with the rear camera.*

#### Loop Recording

Default setting: 1 Minute

Video will be continually recorded in segments. When the storage limit is reached on the memory card, new recordings will automatically overwrite the oldest recordings. **Locked video files on the memory card will remain protected and won't be overwritten by Loop Recording.**



*Note: Turning Loop Recording off will require you to manually clear recordings from your memory card whenever storage is full. We highly recommend keeping Loop Recording enabled.*

#### WDR (Wide Dynamic Range)

Default setting: On

The camera automatically adjusts exposure settings to provide balanced lighting and clear video.

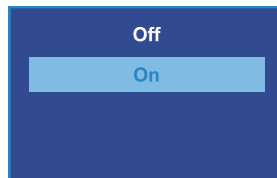

## Exposure

Default setting: +0.0

Manually adjust the camera's exposure value to brighten or darken recordings. Positive values brighten recordings while negative values darken them.

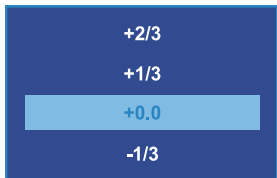

## Record Audio

Default setting: On

Allows you to enable or disable audio recording with your videos.

You may choose to record audio with video or turn off the microphone so all recorded videos will be muted.

*Note: You can also use the **MIC** button to toggle auto recording.*

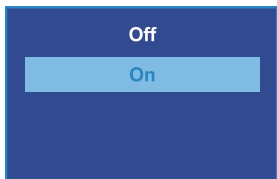

## Date Stamp

Default setting: On

Stamp the date and time to the bottom of your videos. Note that the date and time stamp cannot be removed from videos if this feature was enabled at the time of recording.

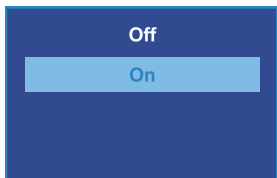

## Gravity Sensing

Default setting: Low

If a change in gravitational forces is detected, such as in the event of a vehicular accident, the G-sensor will signal to the camera, and an automatic file lock will be placed on the current video, preserving your most crucial footage. Locked videos can be found on the memory card under "\CARD\MOVIE\RO".

*Note: Locked video files won't be erased by Loop Recording. They will remain on the memory card until they are manually deleted or when the card is formatted.*

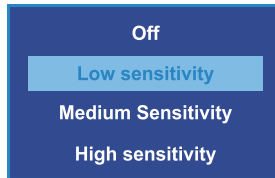

## Plate Number

Default setting: Off

Enter your vehicle plate number. The plate number will be displayed at the bottom of your videos.

To enter your license plate number:

- **UP / DOWN** – Change current value
- **OK** – Move to next value
- **MENU** – Confirm setting

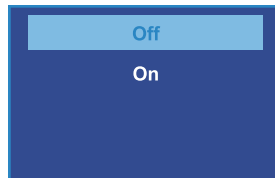

## IR Light

Default setting: Auto

Auto handle low light conditions and ensures flawless video footage even when the passenger cabin is dark.

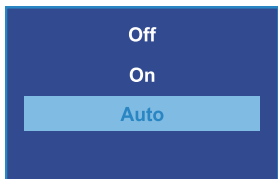

## Daylight Savings

Default setting: Off

When enabled, time is advanced forward by 1 hour to match daylight savings time.

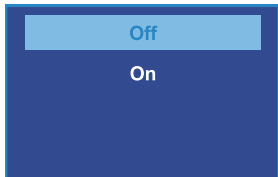

## GPS Speed Unit

Default setting: mi/h

Display speed information at the bottom of your recordings.



## Set Time Zone

Default setting: Off

Updates the time automatically with your time zone.



## ADAS (Advanced Driver Assistance System)

Default setting: Off

When your car begins to move out of its lane or too close to the car in front of you, Rexing dash cam will sound a voice alarm to warn you of the driving safety.

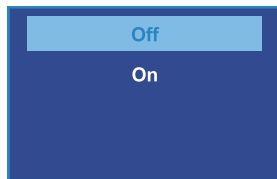

## Parking Monitor

Connect the dash cam to the smart hardwire kit (needs to be purchased separately) to activate the parking monitor function.

Once the parking monitor function is enabled, you can choose from G-Sensor mode or Time Lapse mode.



## G-Sensor

When a collision is detected while the car is parking, the camera will turn on and record a 20-second video clip, which will be locked securely from being overwritten.

*Pros:* G-Sensor mode is more energy efficient.

*Cons:* It may miss recording some videos in the sleep mode.



## Time Lapse

After the car is turned off, the dash cam will perform as usual, but the camera will capture videos and frames re-specified intervals of time and condense them into a video time lapse, which means your footage appears to be faster upon playback.

*Pros:* Dash cam will record everything after the car engine is turned off.

*Cons:* It may drain your car battery; however, the smart hardware kit has low voltage protection function. When the smart hardware kit detected low car battery, the dash cam will automatically shut down to protect your car battery

## System Settings

Press **MENU** twice to open the Setup Menu (in Video Recording Mode, you must first stop recording which is done by pressing **UP**).

### Wi-Fi

Default setting: Off

Turn this feature on to temporarily enable Wi-Fi feature (See Page 25).

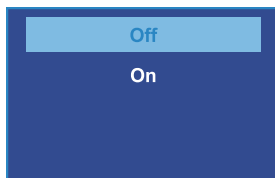

### Date/Time

Set the time and date on your device.

To enter the date/time:

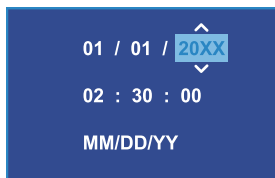

- **UP / DOWN** – Change current value
- **OK** – Move to next value
- **MENU** – Confirm setting

### Auto Power Off

Default setting: Off

When enabled, this feature allows the device to shut down after a period of time in which the camera isn't recording.

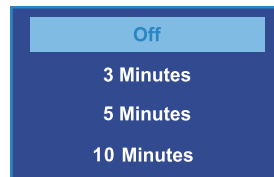

### Volume

Default setting: High

Enable or disable the device's sound effects.



### Language

Default setting: English

Set your preferred device language.



### Frequency

Default setting: 60 Hz

Power supply specification used in your country or geographical region. The United States users should use 60 Hz (default).

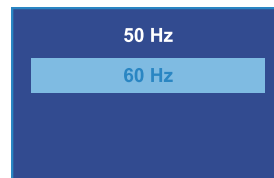

## Screen Saver

Default setting: Off

Specifies the duration for which the display will stay on after the device is powered on. Having this setting disabled (default) will keep the display on constantly. You can press any button to wake the device from screen saver mode.

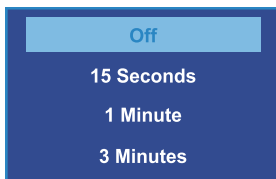

## Format

Performing this operation will format the memory card, and clearing off all files.

*Note: Locked videos will also be cleared, so ensure you have backed up your important footage before formatting the card.*

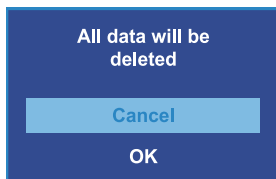

## Default Setting

Performing this operation will reset all settings to their default values.

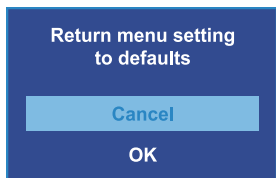

## Version

Displays the current device firmware information.

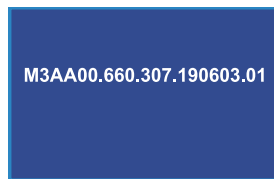

## Photo Settings

These settings affect your still photo captures. Hold **MENU** button for 3 seconds to enter the Photo Mode. In Photo Mode, Press **MENU** once to open the Still Menu.

### Capture Mode

Default setting: Single

Sets a timer that counts down before capturing images.



### Resolution

Default setting: 5M

Set the pixel resolution for captured images. Higher resolution images are more detailed but take up more space on the memory card.



## Quality

Default setting: Normal

Set the quality level of captured images. Lower quality images will take up less space on the memory card, but they are more visually compressed than higher quality images.



## Sharpness

Default setting: Normal

Automatically enhance images for a clearer, more distinct picture.



## White Balance

Default setting: Auto

Adjust the white balance for different lighting environments. When set to Auto, the camera will automatically determine the appropriate white balance for each shot.

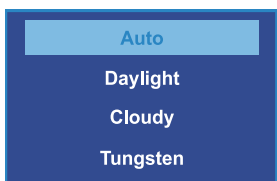

## Color

Default setting: Color

Overlay a color effect for captured images. When set to Normal, no overlay is applied.

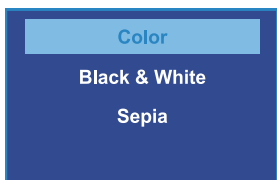

## ISO

Default setting: Auto

Adjust the camera's sensitivity to light when taking photos. The higher the ISO, the better the camera operates in low light, although images are produced with more noise (grainy-looking).



## Exposure

Default setting: +0.0

Adjust the camera exposure value to manually brighten or darken your images.

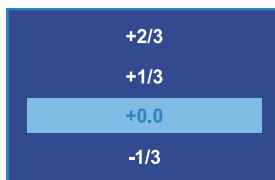

## Anti-Shaking

Default setting: On

When enabled, the camera will automatically reduce the amount of blurriness resulting from quick or "shaky" movement.



## Quick Review

Default setting: Off

Upon capturing an image, the image will be previewed on the display for a few seconds before returning to Photo Mode.

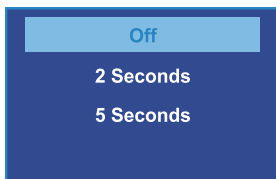

## Date Stamp

Default setting: Date/Time

Apply a date and/or time stamp to captured images (works similarly to the Date Stamp function in the Video Menu on page 28).



## 6. Troubleshooting

### Updating Firmware

Please note that we only recommend updating your firmware if you experience issues with your camera.

Installing incorrect firmware can damage your device. Identify the correct firmware for your camera by following the prompts on the [rexingusa.com](https://www.rexingusa.com) firmware portal.



Watch our video tutorial on  
<https://youtu.be/0hRcKo0Bmko>

### To update your camera's firmware:

1. Format the memory card using the Format function (See Page 16).
2. Take note of your firmware version number (See Page 35 – Version).
3. On a computer, visit the firmware section of [rexingusa.com](https://www.rexingusa.com) and follow the prompts to locate the correct firmware for your camera.
4. Download the firmware zip file to your computer.
5. Unzip the file.
6. Move the resulting file (.bin) to the root of your memory card.
7. Safely eject the card from computer, then insert into your unpowered camera.
8. Turn the camera on **by connecting to a power source**.
9. The camera will update automatically. The screen will stay off but the status light will stay on for up to 1 minute while the firmware updates.
10. **Important! Memory card needs to be formatted again after updating.** Failure to do this will result in the camera attempting to update the firmware every time it's powered on.
11. After formatting, hold the **POWER** button to reboot the camera. **DO NOT disconnect the camera from the power source.**
12. Upon reboot, you may disconnect your camera from power.

## 7. Product Specifications

Image Sensor	Front - Sony Starvis, Cabin - OV2053
Lens	Fixed-focus with full-glass elements
Aperture	f1.8
CPU Class	Novatek 96660
Display	2.7 inch, 16:9 LCD
Audio I/O	Internal high-sensitivity mic and speaker
Memory Support	Class 10 or higher Micro SD card (up to 256GB)
Gravity Sensor	Low / Medium / High / Off
White Balance	Auto
Exposure	Auto ISO
Battery Type	Supercapacitor
Video Format	h.264 (.MOV)
Video Resolution – Single	2160p24f, 1440p30f, 1080p60f, 1080p30f, 720p60f, 720p30f
Video Resolution – Dual	1080p30f+1080p30f, 720p30f+720p30f
Language	English, Chinese, French, Spanish, Portuguese, German, Italian, Russian, Japanese

Loop Recording	1 min / 2 mins / 3 mins / Off
Screen Saver	15 secs / 1 min / 3 mins
Audio Recording	On / Off
GPS Logger	Built-in
Wi-Fi	Built-in

## 8. Warranty & Support

### Warranty

The Rexing V3 Dash Cam comes with a full 12-month warranty. If you register your product on our official site (<https://www.rexingusa.com/support/registration>), you can extend the warranty to 18 months.

### Support

If you have any questions regarding your product, please do not hesitate to contact us at [care@rexingusa.com](mailto:care@rexingusa.com), or call us at (203) 800-4466. Queries are typically answered within 12-24 hours.

### Your opinion matters

Rexing is firmly committed to always improving our products, services, and user experience. If you have any thoughts on how we can do even better, we welcome your constructive feedback and suggestions.

Connect with us today at [care@rexingusa.com](mailto:care@rexingusa.com)

Thank you for choosing Rexing!

