

BF25292

PAPASAN CHAIR

ASSEMBLY INSTRUCTIONS

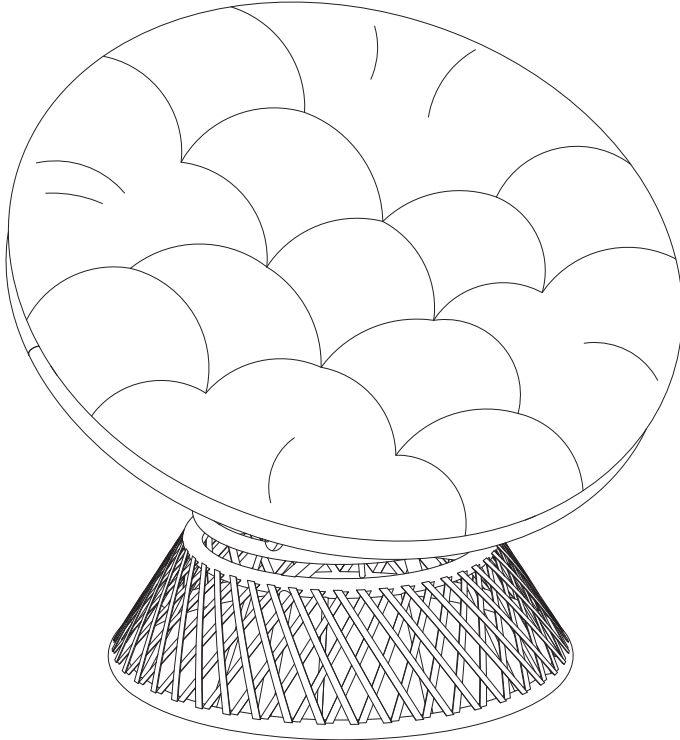

WARNING

1. Do not use this product unless all screws and bolts are securely tightened.
2. Check that all screws and bolts are tight every three months or as needed.
3. Dispose of packing material properly. Do not use plastic cover as head covering. It may cause suffocation.
4. Do not use this product as a stepladder.
5. Use this product for its intended purpose only.
6. **Intended for residential use only.**

OSP DESIGNS LIMITED WARRANTY

OSP Designs warrants, to the original purchaser its products to be free from defects in material and workmanship for a period of 90 days. Defects and damage from misuse, abuse, negligence, alteration, accident, vandalism, rusting, acts of nature or any other event beyond the control of OSP Designs is not covered. The warranty does not cover cosmetic damage that may result from normal use. Liability for incidental or consequential damages is excluded. The user assumes all risk of injury resulting from use of this product. This warranty gives you specific legal rights, and you may also have other rights which vary from state to state.

To make a warranty claim, contact Parts Department. Provide model number, proof of purchase, description of the problem and obtain return authorization. At its option Office Star Products will:

- (a) Supply compatible components of current manufacture.
- (b) Repair the customer's component. The customer must prepay freight on any components returned to the factory. Return freight on components still in warranty will be paid by Office Star Products.

Our quality standards are among the highest in the industry. Sometimes, no matter how hard we try, there are times when parts are damaged or missing. Our Parts Department will do everything possible to promptly remedy the problem. Contact us via e-mail parts@officestar.net, by Fax 1-909-930-5629, or toll free parts number 1-800-950-7262, Monday through Friday 8:00 a.m. - 5:00 p.m. Pacific Time.

PARTS LIST

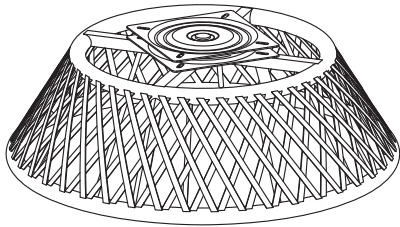

(A) Base (1 PC)

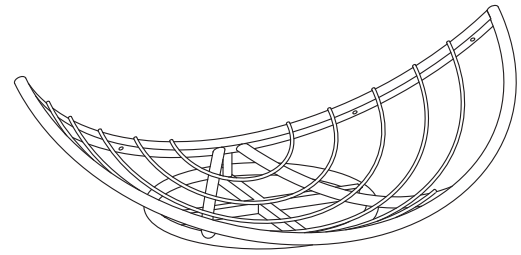

(B) Bottom Frame (1 PC)

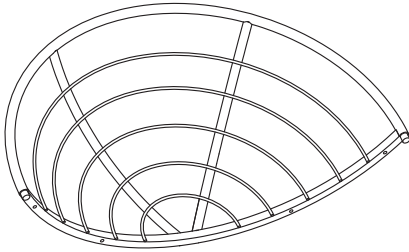



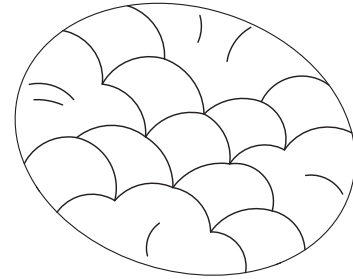

(C) Top Frame (1 PC)



(D) Cushion (1 PC)

HARDWARE LIST

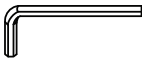
NO	DRAWING	DESCRIPTION	SIZE	QUANTITY
1		Bolt	M6 x 15mm	4 PCS + 1 EXTRA
2		Bolt	M6 x 40mm	4 PCS + 1 EXTRA
3		Flat Washer	n / a	12 PCS + 2 EXTRA
4		Nut	M6	4 PCS + 1 EXTRA
5		Wrench	n / a	1 PC
6		Allen Wrench	4mm	1 PC

STEP 1

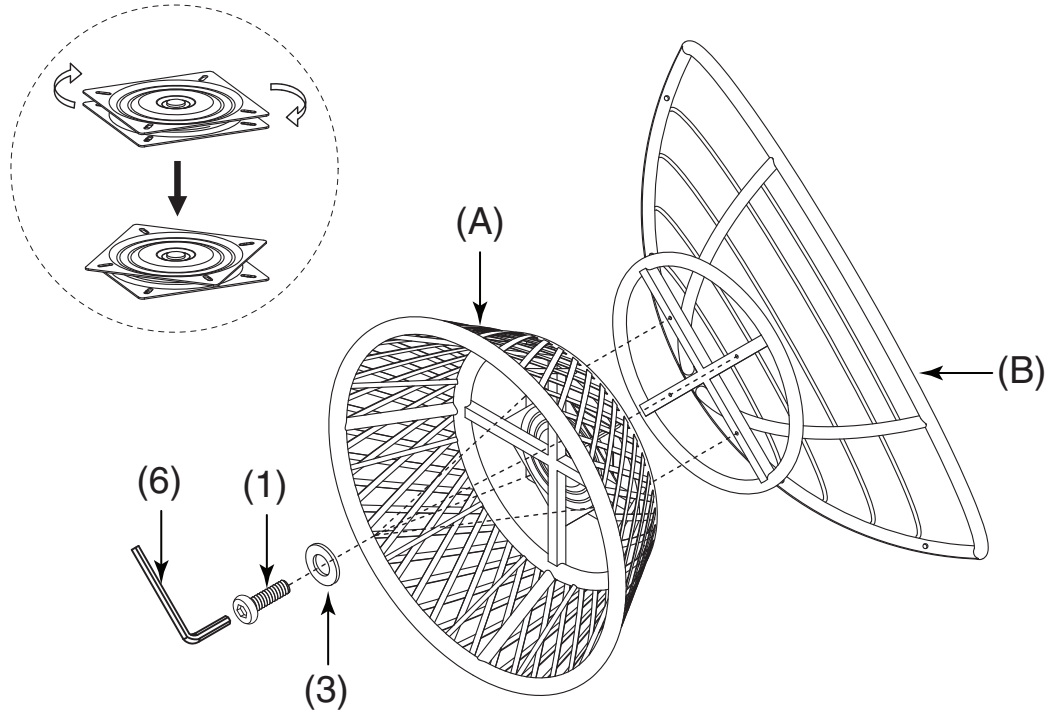

FULLY TIGHTEN ALL BOLTS

STEP 2

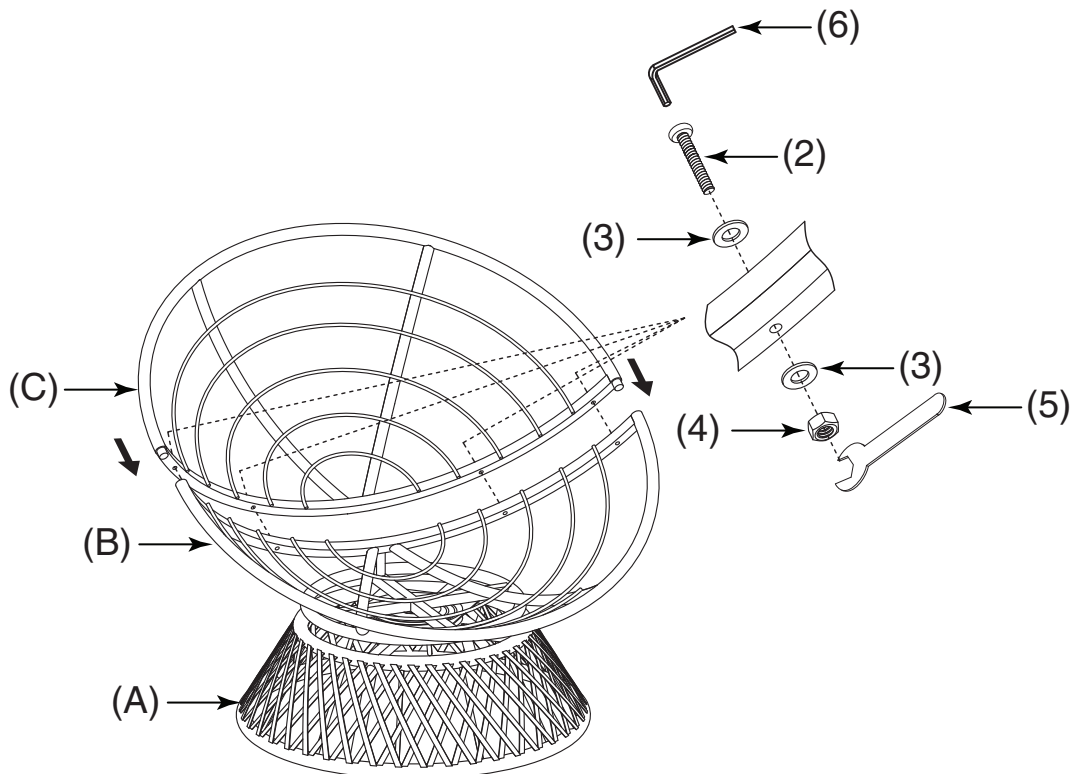

FULLY TIGHTEN ALL BOLTS

STEP 3

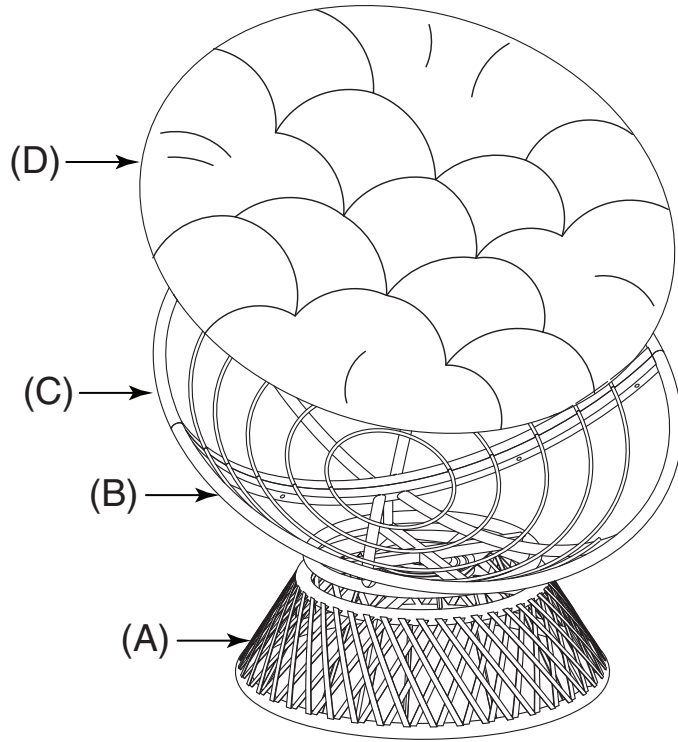

STEP 4

