

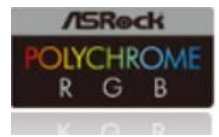

UX 200

ARGB Lighting CPU Cooler



Thermaltake Air Cooler UX 200



UX 200

ARGB Lighting CPU Cooler



產品規格：

Unit :mm

P/N	CL-P065-AL12SW-A
Compatibility (CPU Socket)	Intel LGA 1156/1155/1151/1150/775 AMD AM4/FM2/FM1/AM3+/AM3/AM2+/AM2
Dimension	127 x 76 x 153.5 mm (L x W x H)
Heatsink Material	Aluminum Fins Copper Heatpipes
Heatpipe	Φ6mm x 4 pcs
Fan Dimension	120 x 120 x 25 mm (L x W x H)
Fan Quantity	1pcs
Fan Speed	PWM 300 ~ 1500 RPM
Rated Voltage	12V
Start Voltage	6.0 V
Rated Current	0.48 A
Power Input	5.76 W
Air Flow.	43.34 CFM
Air Pressure.	1.18 mm-H ₂ O
Acoustical Noise.	26.33 dBA
Life Time	30,000 hours
Pin Connect	5V RGB header 2510 - 4Pin
Cooling Power	130 W



Features :

- Support MB RGB LED 5V sync, ASUS, GIGABYTE, MSI and ASROCK
- Build-In ARGB LEDs offer best lighting effect
- 4 x Ø6 mm high performance U-shape copper heatpipes support up to 130W
- 120mm Quiet-Fan With 15 LED lighting
- 9 high Air Flow blade design for high cooling performance
- Long life hydraulic bearing for reliable and silent operation
- Universal Intel/ AMD socket compatibility

Dimension :

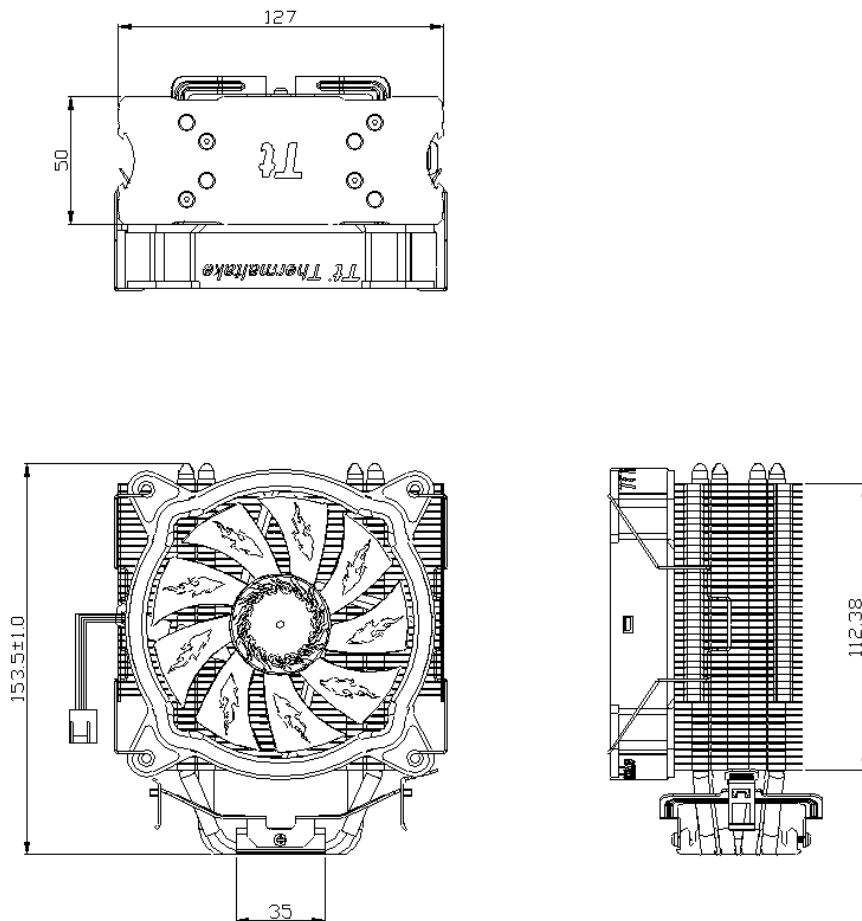

Thermaltake Air Cooler UX 200



Angle View :



Top View



Bottom View



Front View

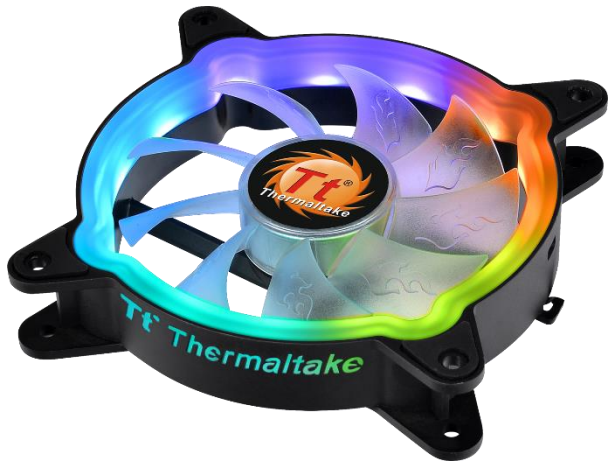

Fan



Universal Socket & Fan Clip



Heat-pipes Direct Touch Technology

Thermaltake Air Cooler UX 200



Features :



**Performance optimized
fin design**



**Fully Intel & AMD Socket
Premium thermal grease**



Application

Sync 5V LED

Support ASUS, MSI, GIGABYTE and ASROCK 5V RGB motherboard Sync.

***Caution: the motherboard signal connector only supports 5V header.**



Aura Addressable Header



JRAINBOW Header



Addressable RGB LED Header



Digital Pin Header

MB SYNC

ASUS
Aura Addressable Strip Header(s)

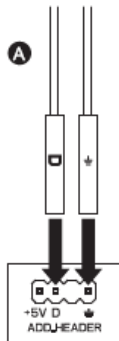

MSI
JRGB-strip Header(S)

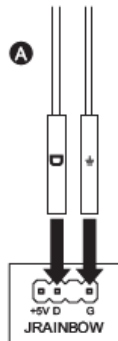

ASROCK
Addressable RGB LED Header(s)

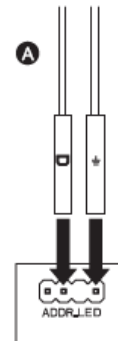

GIGABYTE
AOURS RGB Fusion with Digital LEDs

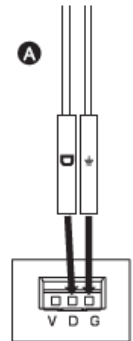

CAUTION

Please power off the PC and check the Positive and Negative ends on the connector before connecting the cable to mainboard. Connecting the wrong end can damage the fans.

Thermaltake Air Cooler UX 200



UX 200

ARGB Lighting CPU Cooler

