

User Guide

INSIGNIA™

37" and 42" LCD TV
NS-L37Q-10A/NS-L42Q-10A



Contents

CHILD SAFETY	1
Important safety instructions	2
Warnings	2
Cautions	3
Introduction	4
Installing a wall-mount bracket	4
NS-L37Q-10A (37-inch)	4
NS-L42Q-10A (42-inch)	4
TV components	5
Accessories	5
Cleaning cloth	5
Front	5
Back	6
Side	6
Remote control	7
Using the remote control	8
Installing the remote control batteries	8
Aiming the remote control	8
Using the remote control holder	9
Programming a universal remote control to work with your TV	9
Making connections	9
Connecting the power	9
Connecting an outdoor antenna	9
Connecting an indoor antenna	10
Connecting cable TV	10
Connecting satellite TV via a satellite TV box	11
Connecting a VCR	11
Connecting a camcorder or game console	12
Connecting an HDMI device	12
Connecting a component video device	13
Connecting an S-Video device	13
Connecting a computer	13
Connecting headphones	14
Connecting a digital audio amplifier	14
Connecting an analog audio amplifier	14
Turning on your TV for the first time	15
Understanding the basics	15
Turning your TV on or off	15
Selecting the video input source	15
On-screen menu overview	16
Navigating the menus	16
Selecting a channel	17
Adjusting the volume	17
Displaying additional information	17

Adjusting the picture	17
Adjusting the TV picture	17
Adjusting Advanced Video settings	18
Freezing the picture	18
Adjusting the sound	18
Adjusting the sound	18
Playing TV audio only	19
Changing channel settings	19
Automatically scanning for channels	19
Hiding channels	20
Setting up a favorite channel list	21
Viewing a favorite channel	21
Adding or changing a channel label	21
Checking the DTV signal strength	22
Setting parental controls	23
Setting or changing the password	23
Setting parental control levels	23
Blocking unrated TV	25
Downloading rating information	26
Locking control buttons	26
Using closed captioning	27
Viewing closed captioning	27
Selecting the closed captioning mode	27
Customizing DTV closed captioning styles	27
Adjusting time settings	28
Setting the clock	28
Setting the sleep timer	29
Adjusting menu settings	29
Selecting the menu language	29
Changing the menu transparency	30
Labeling an input source	30
Resetting settings to the defaults	31
Programming your remote control	31
Troubleshooting remote control programming	35
Manufacturers' codes	35
Maintaining	47
Cleaning the TV cabinet	47
Cleaning the TV screen	47
Troubleshooting	47
Specifications	48
Legal notices	49
Two-year limited warranty	51

CHILD SAFETY

It makes a difference how and where you use your flat panel display

As you enjoy your new product, keep these safety tips in mind

The issue

The home theater entertainment experience is a growing trend, and larger TVs are popular purchases. However, TVs are not always supported on the proper stands or installed according to the manufacturer's recommendations. We and the consumer electronics industry are committed to making home entertainment enjoyable and safe.

TVs that are inappropriately placed on dressers, bookcases, shelves, desks, speakers, chests, or carts may fall over and cause injury.

Tune into safety

- One size of TV stand does **not** fit all. Use only a TV stand rated for the weight of your TV.
- Carefully read and understand all enclosed instructions for proper use of this product.
- Don't let children climb on or play with entertainment system furniture and TVs.
- Don't place TVs on furniture that can easily be used as steps, such as a chest of drawers.
- Remember that children can become excited while watching a program, especially on a "larger-than-life" TV. Make sure that you place or install the TV where it cannot be pushed, pulled over, or knocked down.
- Make sure that you route all cords and cables so that they cannot be pulled or grabbed by curious children.



Wall mounting

If you decide to wall mount your TV, always remember:

- One size of wall mount does **not** fit all. Use only a wall mount rated for the weight of your TV and that has been recommended by this TV manufacturer, listed in this manual, or otherwise listed by an independent laboratory as suitable for your TV.
- Follow all instructions supplied by the TV and wall mount manufacturers.
- If you have any doubts about your ability to safely wall mount your TV, get help from a professional installer.
- Make sure that the wall where you are mounting the TV is appropriate. Some wall mounts are not designed to be mounted to walls backed with steel studs or cinder blocks. If you are unsure, ask a professional installer.
- TVs can be heavy. At least two people are required for safe wall mount installation.



Important safety instructions



This symbol indicates that dangerous voltage constituting a risk of electric shock is present within your TV. This label is located on the back of your TV.



This symbol indicates that there are important operating and maintenance instructions in the literature accompanying your TV.

- 1 Read these instructions.
- 2 Keep these instructions.
- 3 Heed all warnings.
- 4 Follow all instructions.
- 5 Do not use this apparatus near water.
- 6 Clean only with dry cloth.
- 7 Do not block any ventilation openings. Install in accordance with the manufacturer's instructions.
- 8 Do not install near any heat sources such as radiators, heat registers, stoves, or other apparatus (including amplifiers) that produce heat.
- 9 Do not defeat the safety purpose of the polarized or grounding-type plug. A polarized plug has two blades with one wider than the other. A grounding type plug has two blades and a third grounding prong. The wide blade or the third prong are provided for your safety. If the provided plug does not fit into your outlet, consult an electrician for replacement of the obsolete outlet.
- 10 Protect the power cord from being walked on or pinched particularly at plugs, convenience receptacles, and the point where they exit from the apparatus.
- 11 Only use attachments/accessories specified by the manufacturer.
- 12 Use only with a cart, stand, tripod, bracket, or table specified by the manufacturer, or sold with the apparatus. When a cart is used, use caution when moving the cart/apparatus combination to avoid injury from tip-over.  S3125A
- 13 Unplug this apparatus during lightning storms or when unused for long periods of time.
- 14 Refer all servicing to qualified service personnel. Servicing is required when the apparatus has been damaged in any way, such as power-supply cord or plug is damaged, liquid has been spilled or objects have fallen into the apparatus, the apparatus has been exposed to rain or moisture, does not operate normally, or has been dropped.

- 15 The *mains plug* is the disconnecting device. The plug must remain readily operable.
- 16 The apparatus with grounding-type plug is a class I apparatus. Class I apparatus need to be connected to earth ground wire to prevent possible electric shock. Make sure that you connect the class I apparatus to a mains socket outlet with a protective earthing connection.
- 17 Remote control batteries should not be exposed to excessive heat such as sunshine, fire, or the like.
- 18 The apparatus shall not be exposed to dripping or splashing, and no objects filled with liquids, such as vases, shall be placed on the apparatus.

Warnings

Electric shock hazard

To reduce the risk of fire or electric shock, do not remove any cover or expose the device to rain or moisture. No user-serviceable parts are inside. Refer servicing to qualified service technicians.

Lightning

For added protection for your device receiver during a lightning storm, or when it is left unattended and unused for long periods of time, unplug it from the power outlet and disconnect any antenna or cable system. This helps prevent property damage and personal injury from lightning and power line surges.

Power lines

An outside antenna system should not be located in the vicinity of overhead power lines or other electric light or power circuits, or where it can fall into such power lines or circuits. When installing an outside antenna system, extreme care should be taken to keep from touching such power lines or circuits as contact with them might be fatal.

Handling the LCD panel

- Your TV's screen is made of glass. Do not drop your TV or hit, jolt, or press hard against the LCD panel. If the screen breaks, be careful of broken glass.
- If the LCD panel is broken, make absolutely sure that you do not touch the liquid in the panel. This may cause skin inflammation.
- If the liquid gets in your mouth, immediately gargle, rinse, and consult with your doctor. Also, if the liquid gets in your eyes or touches your skin, consult with your doctor after rinsing for at least 15 minutes or longer in clean water.

Replacement parts

When replacement parts are required, make sure that the service technician uses replacement parts specified by the manufacturer that have the same characteristics as the original part. Unauthorized substitutions may result in fire, electric shock, personal injury, or other hazards.

Safety check

After completing any service or repair to this device, ask the service technician to perform routine safety checks to determine that your TV is in correct operating condition.

Power source

Operate your TV only from the type of power source indicated on the marking label. If you are not sure of the type of power supplied to your home, consult an electrician or your local power company.

Cautions

Damage requiring service

Unplug this TV from the power outlet and refer servicing to qualified service personnel under the following conditions:

- When the power supply cord or plug is damaged or frayed.
- If liquid has been spilled or objects have fallen into your TV.
- If your TV has been exposed to rain or water.
- If your TV does not operate normally by following the operating instructions. Adjust only those controls that are covered by the operating instructions because incorrect adjustment of other controls may result in damage and will often require extensive work by a qualified technician to restore your TV to its normal operation.
- If your TV has been dropped or damaged in any way.
- When your TV exhibits a distinct change in performance.

Outdoor antenna grounding

If an outside antenna or cable system is connected to your TV, make sure that the antenna or cable system is grounded to provide some protection against voltage surges and built-up static charges. Article 810 of the National Electrical Code, ANSI/NFPA No. 70, provides information with respect to correct grounding of the mast and supporting structure, grounding of the lead-in wire to an antenna discharge unit, size of grounding conductors, location of the antenna-discharge unit, connection to grounding electrodes, and requirements for the grounding electrode.

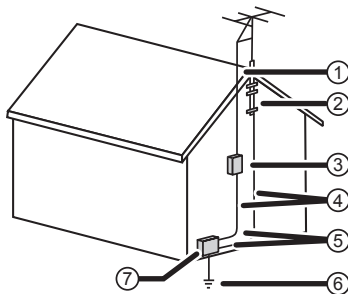

- ① Antenna lead-in wire
- ② Grounding clamp
- ③ Antenna discharge unit
- ④ Grounding conductors
- ⑤ Ground clamps
- ⑥ Power service grounding electrode system
- ⑦ Electric service equipment

Note to CATV system installer

Article 820 of the National Electrical Code, ANSI/NFPA No. 40 provides guidance for correct grounding. Specifically, it states that the cable ground must be connected to the grounding system of the building as close to the point of cable entry as practical.

Condensation

Moisture will form on the TV if the TV is brought from cool surroundings into a warm room or if the temperature of the room rises suddenly. When this happens, the TV's performance may be impaired. To prevent this, let the TV stand in its new surroundings for about an hour before switching it on, or make sure that the room temperature rises gradually.

Condensation may also form during the summer if the TV is exposed to the breeze from an air conditioner. In such cases, change the location of the TV.

Mobile telephone warning

To avoid interference with your TV picture and sound, operating problems, or even damage, keep your cordless and cellular telephones away from the TV.

End of life directives

Your TV contains tin-lead solder and a fluorescent lamp containing a small amount of mercury. Disposal of these materials may be regulated for environmental reasons. Your TV also contains material that can be recycled and reused. For disposal or recycling information, contact your local authorities or the Electronic Industries Alliance at www.eia.org to find a recycler in your area.

Non-active pixels

The LCD panel contains almost 3 million thin film transistors, which provide exceptionally sharp video quality. Occasionally, a few non-active pixels may appear on the screen as a fixed blue, green, or red point. These non-active pixels do not adversely affect the performance of your TV, and are not considered defects.

Introduction

Congratulations on your purchase of a high-quality Insignia product. Your NS-L37Q-10A or NS-L42Q-10A represents the state of the art in LCD TV design and is designed for reliable and trouble-free performance.

Installing a wall-mount bracket

Warning

This apparatus is intended to be supported by UL Listed wall mount bracket.

To install a wall-mount bracket:

Warning

These servicing instructions are for use by qualified service personnel only. To reduce the risk of hazards, do not perform any servicing other than that contained in the operating instructions unless you are qualified to do so.

NS-L37Q-10A (37-inch)

- 1 Remove the four screws that secure the stand to your TV.

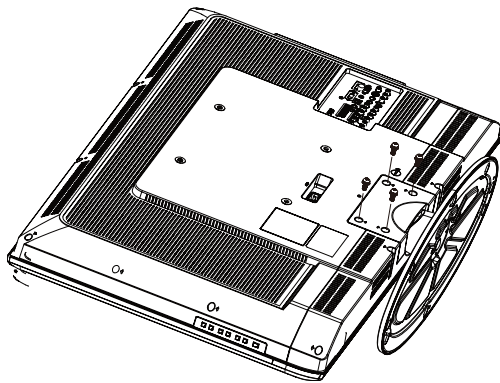

- 2 Remove the stand.

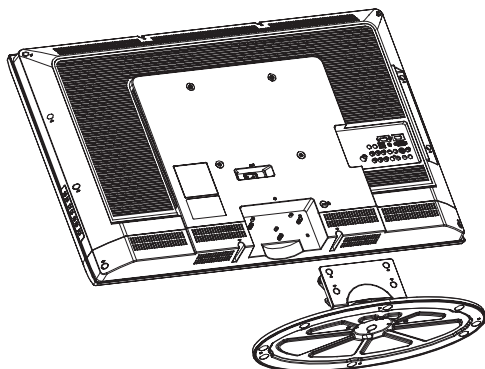

- 3 Attach the wall-mount bracket with M6 screws (not included).

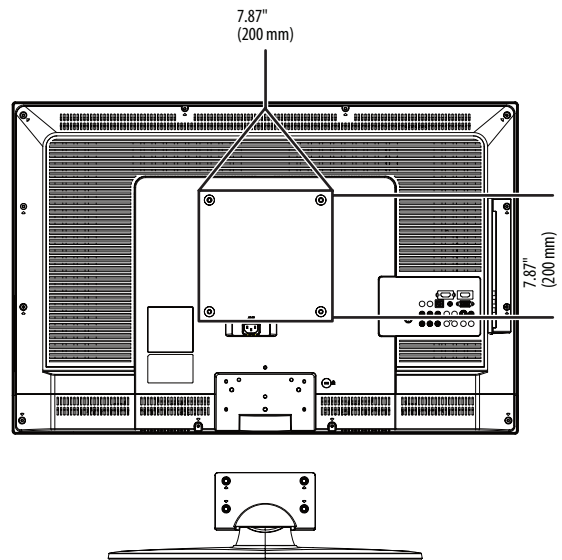

NS-L42Q-10A (42-inch)

- 1 Remove the four screws on the back of the stand's back cover, then remove the stand's back cover.

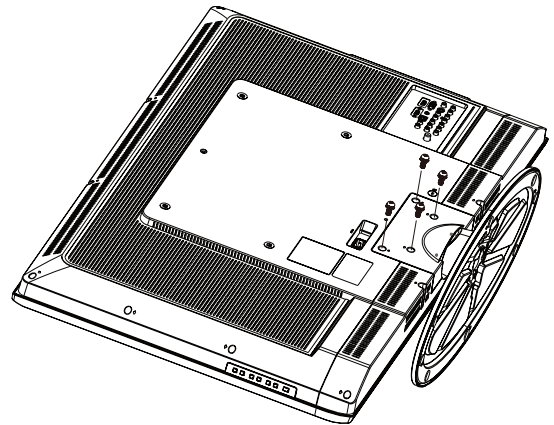

- 2 Remove the screw that secures the stand to your TV, then remove the stand.

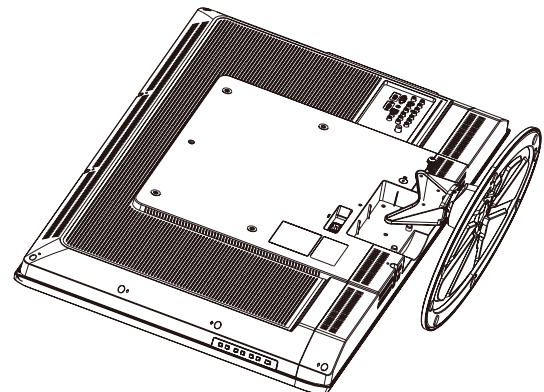

- 3 Attach the wall-mount bracket with M6 screws (not included).

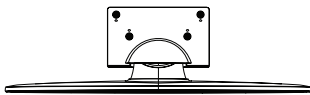
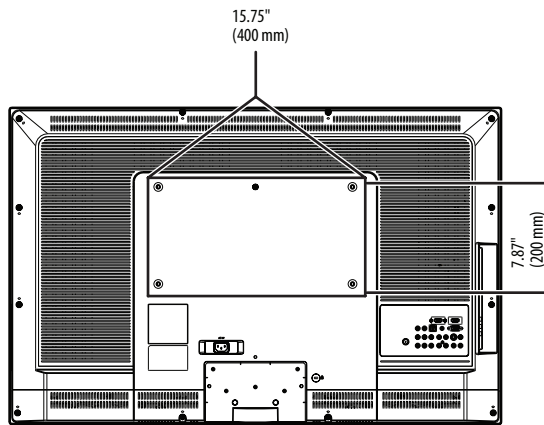

Front

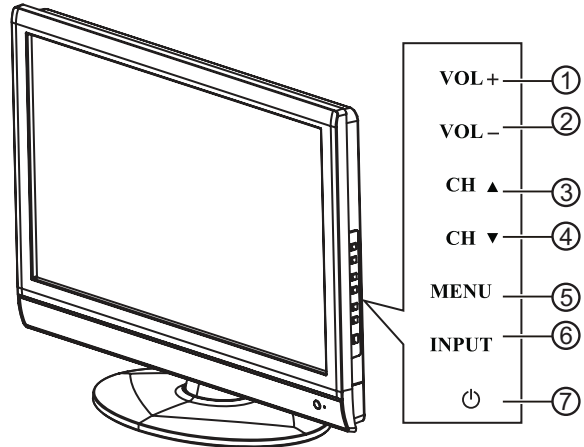

TV components

Accessories

Make sure that the following accessories are provided in the packaging:

- Remote control
- AA batteries (2)
- Remote control holder
- AC power cord
- Component cable
- Cleaning cloth
- *User Guide*
- *Quick Setup Guide*

Cleaning cloth

The cleaning cloth is for cleaning the TV screen only. Do not use the cleaning cloth to clean any other part of your TV.

#	Button	Description
①	VOL+	Press to increase the volume. In Menu mode, functions as the right arrow to go to the next menu or increase a setting.
②	VOL-	Press to decrease the volume. In Menu mode, press to decrease a setting.
③	CH ▲	Press to go to the next higher channel. In Menu mode, functions as the up arrow.
④	CH ▼	Press to go to the next lower channel. In Menu mode, functions as the down arrow.
⑤	MENU	Press to open the on-screen menu.
⑥	INPUT	Press to open the input source menu, then press the arrow keys to cycle through the available input sources. In Menu mode, functions as the OK/ENTER button.
⑦	⏻ (power)	Press to turn your TV on or off (standby mode). When your TV is off, power still flows into it. To disconnect power, unplug the power cord.

Back

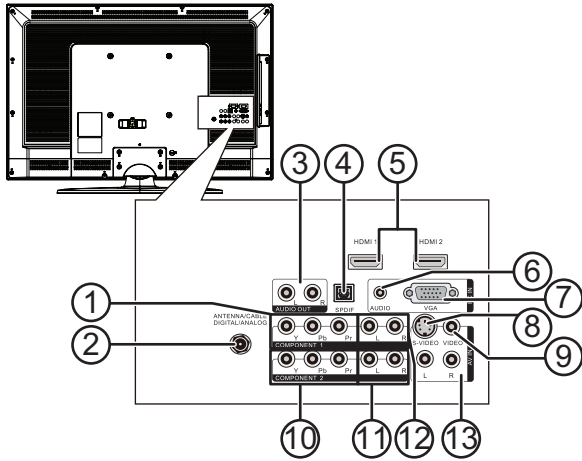

Side

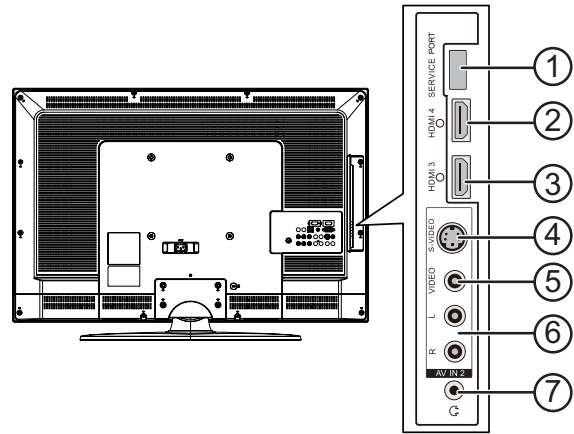

#	Jack	Description
①	COMPONENT 1 Y/Pb/Pr	Connect the video for a component video device to these jacks. For more information, see "Connecting a component video device" on page 13.
②	ANTENNA/CABLE DIGITAL/ANALOG	Connect an antenna or cable TV to this jack. For more information, see "Connecting an outdoor antenna" on page 9 or "Connecting cable TV" on page 10.
③	AUDIO OUT R / L	Connect an external sound system to these jacks. For more information, see "Connecting an analog audio amplifier" on page 14.
④	SPDIF	Connect an audio amplifier to this jack. For more information, see "Connecting a digital audio amplifier" on page 14.
⑤	HDMI 1/HDMI 2	Connect HDMI devices to these jacks. For more information, see "Connecting an HDMI device" on page 12.
⑥	PC IN AUDIO	Connect the audio for a computer to this jack. For more information, see "Connecting a computer" on page 13.
⑦	PC IN VGA	Connect the video (VGA) for a computer to this jack. For more information, see "Connecting a computer" on page 13.
⑧	AV IN 1 S-VIDEO	Connect the video for an S-Video device to this jack. For more information, see "Connecting an S-Video device" on page 13.
⑨	AV IN 1 VIDEO	Connect the video for a standard AV device to this jack. For more information, see "Connecting a VCR" on page 11.
⑩	COMPONENT 2 Y/Pb/Pr	Connect the video for a component video device to these jacks. For more information, see "Connecting a component video device" on page 13.
⑪	COMPONENT 2 L/R	Connect the audio for a component video device to these jacks. For more information, see "Connecting a component video device" on page 13.
⑫	COMPONENT 1 L/R	Connect the audio for a component video device to these jacks. For more information, see "Connecting a component video device" on page 13.
⑬	AV IN 1 L/R	Connect the audio for an S-Video or standard AV device to these jacks. For more information, see "Connecting an S-Video device" on page 13 or "Connecting a VCR" on page 11.

#	Jack	Description
①	SERVICE PORT	For service only.
②	HDMI 4	Connect an HDMI device to this jack. For more information, see "Connecting an HDMI device" on page 12.
③	HDMI 3	Connect an HDMI device to this jack. For more information, see "Connecting an HDMI device" on page 12.
④	AV IN 2 S-VIDEO	Connect the video for an S-Video device to this jack. For more information, see "Connecting an S-Video device" on page 13.
⑤	AV IN 2 VIDEO	Connect the video for a standard AV device to this jack. For more information, see "Connecting a VCR" on page 11.
⑥	AV IN 2 L/R	Connect the audio for an S-Video or standard AV device to these jacks. For more information, see "Connecting an S-Video device" on page 13 or "Connecting a VCR" on page 11.
⑦	(headphone)	Connect headphones to this jack. For more information, see "Connecting headphones" on page 14.

Remote control

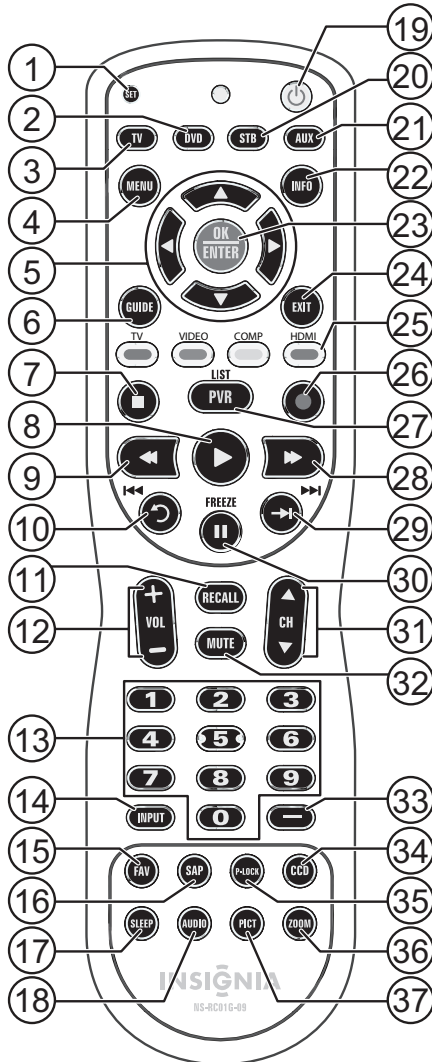

#	Button	Description
①	SET	Press to program the remote control to control connected devices. For more information, see "Programming your remote control" on page 31.
②	DVD	Press to control a connected DVD player. You must program the remote control before this button works. For more information, see "Programming your remote control" on page 31.
③	TV	Press to control your TV.
④	MENU	Press to open the on-screen menu.
⑤	◀ ▶ ▲ ▼	Press to move left, right, up, or down in on-screen menus.
⑥	GUIDE	Press to display the program guide. For more information, see "Displaying additional information" on page 17.
⑦	■ (stop)	Press to stop playback on DVD, DVR, PVR, or CD devices. You need to program the remote control to control connected devices. For more information, see "Programming your remote control" on page 31.
⑧	▶ (play)	Press to start playback on DVD, DVR, PVR, or CD devices. You need to program the remote control to control connected devices. For more information, see "Programming your remote control" on page 31.

#	Button	Description
⑨	◀◀ (fast reverse)	Press to fast reverse on DVD, DVR, PVR, or CD devices. You need to program the remote control to control connected devices. For more information, see "Programming your remote control" on page 31.
⑩	◀◀ / ▶ (skip back)	In DVD, DVR, PVR, or CD mode, press to skip back to the previous title or track. You need to program the remote control to control connected devices. For more information, see "Programming your remote control" on page 31.
⑪	RECALL	In TV mode, press to return to the previous channel.
⑫	VOL+/VOL-	Press to increase or decrease the volume.
⑬	Numbers	Press to enter channel numbers or the parental control password. When programming the remote control, press to enter device and programming codes.
⑭	INPUT	Press to open the Source List, then press ▲ or ▼ to cycle through the available input sources. For more information, see "Selecting the video input source" on page 15.
⑮	FAV	Press to open the Favorite Channel list. For more information, see "Setting up a favorite channel list" on page 21.
⑯	SAP	In analog TV mode, press to select Stereo , Mono or SAP . In digital TV mode, press to select the audio track (language). For more information, see "Adjusting the sound" on page 18.
⑰	SLEEP	Press to set the sleep timer. You can select Off , 5 , 10 , 15 , 30 , 60 , 90 , 120 , 180 , or 240 minutes. For more information, see "Setting the sleep timer" on page 29.
⑱	AUDIO	When the Equalizer option is turned on, press to toggle among different Equalizer modes. When the Equalizer option is turned off, toggle to adjust the treble, bass, or SRS TruSurround HD. For more information, see "Adjusting the sound" on page 18.
⑲	⏻ (power)	Press to turn your TV on or off (standby mode). When your TV is off, power still flows into it. To disconnect power, unplug the power cord.
⑳	STB	Press to control a connected set-top box.
㉑	AUX	Press to control a connected device. You need to program the remote control to control connected devices. For more information, see "Programming your remote control" on page 31.
㉒	INFO	Press to display TV status information, such as the channel number, channel name (if available), or signal source. For more information, see "Displaying additional information" on page 17.
㉓	OK/ENTER	Press to confirm selections or changes.
㉔	EXIT	Press to close the on-screen menu.
㉕	Video input buttons	TV —Press to select TV as the video source. VIDEO —Press one or more times to select the device connected to the AV 1 VIDEO , AV 2 VIDEO , or S-VIDEO jack. COMP —Press one or more times to select the device connected to the COMPONENT 1 or COMPONENT 2 video jacks. HDMI —Press one or more times to select the device connected to the HDMI 1 , HDMI 2 , HDMI 3 , or HDMI 4 jack. For more information, see "Selecting the video input source" on page 15.
㉖	● (record)	In DVD, DVR, PVR, or CD mode, press to begin recording. You need to program the remote control to control connected devices. For more information, see "Programming your remote control" on page 31.

#	Button	Description
27	PVR/LIST	Press to list all the recorded programs in a PVR/STB. You need to program the remote control to control connected devices. For more information, see "Programming your remote control" on page 31.
28	▶▶ (fast forward)	Press to fast forward on DVD, DVR, PVR, or CD devices. You need to program the remote control to control connected devices. For more information, see "Programming your remote control" on page 31.
29	▶▶/▶ (skip forward)	In DVD, DVR, PVR, or CD mode, press to skip forward to the next title or track. You need to program the remote control to control connected devices. For more information, see "Programming your remote control" on page 31.
30	II/FREEZE	Press to freeze the video image. Press again to unfreeze the image. For more information, see "Freezing the picture" on page 18. Caution: Do not freeze the video image for long periods of time. You may damage the TV screen.
31	CH ▲/CH ▼	Press to go change TV channels. For more information, see "Selecting a channel" on page 17.
32	MUTE	Press to mute the sound. Press again to restore the sound.
33	—	Press to enter a digital sub-channel number. For more information, see "Selecting a channel" on page 17.
34	CCD	Press to turn closed captioning on or off. You can select CC Off , CC On , or CC On when Mute . For more information, see "Viewing closed captioning" on page 27.
35	P-LOCK	If Parental Lock is turned on, when you enter correct password to unblock the channels, you can press P-LOCK to block the channels again.
36	ZOOM	Press to select the aspect ratio. For more information, see "Adjusting Advanced Video settings" on page 18.
37	PICT	Press to select the video mode. You can select Vivid , Standard , Energy Savings , Theater , Sports , or Custom . For more information, see "Adjusting the TV picture" on page 17.

- Insert two AA batteries into the battery compartment. Make sure that you match the + and - symbols on the batteries with the + and - symbols in the battery compartment.

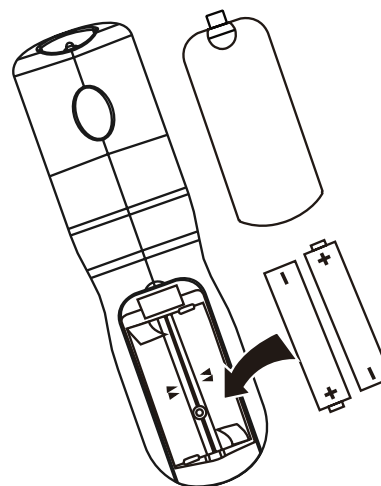

- Replace the battery cover.

Cautions

- Batteries should not be exposed to excessive heat, such as sunshine, heat registers, or fire.
- Battery chemicals can cause a rash. If the batteries leak, clean the battery compartment with a cloth. If chemicals touch your skin, wash immediately.
- Make sure that batteries are disposed of correctly. Do not burn or incinerate.

Notes

- Do not mix batteries of different types.
- Do not mix old and new batteries.
- Remove batteries when the charge is depleted.
- If the remote control is not going to be used for an extended period of time, remove the batteries.

Using the remote control

Installing the remote control batteries

To install the remote control batteries:

- Remove the battery cover.

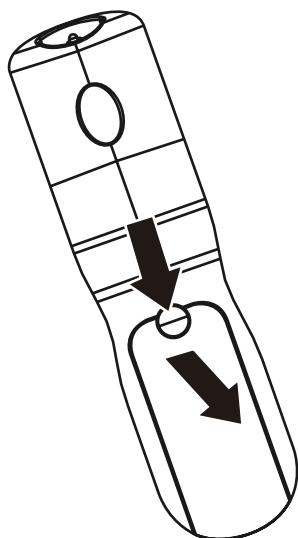

Aiming the remote control

To aim the remote control:

- Point the remote control towards the remote sensor on the front of your TV.

Notes

- Do not expose the remote control to shock or liquids.
- Do not use the remote control in an area with high humidity.
- Do not place the remote control in direct sunlight.
- Do not place objects, such as furniture, between the remote control and the remote sensor.
- The remote control may not work if direct sunlight or bright light shines on the remote sensor. Either move your TV or change the angle at which you use the remote control.

Using the remote control holder

Your TV comes with a remote control holder you can put the remote control in when you are not using it. You can put the holder on a table or mount it on a wall.

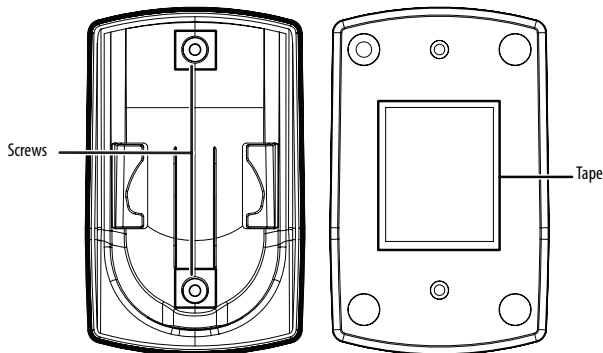

Tips

- Different types of walls may require different types of screws. If you want to wall mount the remote control holder, make sure that you use the correct screws for the type of wall. (Screws are not provided.)
- The remote control holder is shipped with separate adhesive tape for wall mounting. This tape may not work with all types of walls. Make sure that you use the correct tape for the type of wall.

Codes for other remote controls are available online at:

www.insigniaproducts.com/universalcontrolcodes.aspx

Tips

- The brand name is often visible on the front of the universal remote control, and the model number is often visible on the back.
- If your universal remote control isn't listed on the chart, refer to your universal remote control's instructions and try codes for the brands Orion, Emerson, Memorex, Sansui, Sylvania, or Zenith. You may need to try several codes before finding a match.

- 2 Follow your universal remote control's instructions to enter the TV code you found in Step 1.

Tips

- If your universal remote control has a code search feature, run a code search to identify a code that matches your TV. See your universal remote control's instructions for details.
- If your universal remote control has a "Learn" feature, you can manually program it using the Insignia TV remote to "teach" the commands one at a time. See your universal remote control's instructions for details.

- 3 If all else fails, you must use a different universal remote control that can operate both your set-top box and your TV. Four such remotes are listed on the chart, but many other compatible models are available in the market.

For more help, call technical support for your universal remote control or set-top box manufacturer, or call the Insignia Customer Care Center at 1-877-467-4289.

Programming a universal remote control to work with your TV

You can operate your Insignia TV with a new or existing universal remote control.

To program a universal remote control:

- 1 Find the code for your universal remote control by identifying its model (or your set-top box's remote control manufacturer and model) on the charts below, then making note of the numbered code below it. You will use the numbered code to program your remote control to work with your Insignia TV.

Insignia TV codes for universal remote controls (for all Insignia TVs manufactured after Jan. 1, 2007)

Universal remote control manufacturers and models

Philips PHDVD5, PH5D5S, PMDVR8, PDVR8	RCA RCU807	One for All URC-6690	Sony RM-VL600
115	135	0464	8043

Set-top box manufacturers and models

Comcast M1057	Dish Network VIP508, VIP622	Motorola DRC800	TIVO Series 3, HD	DirectTV RC23
0463	720	0463	0091	10463

Making connections

Connecting the power

To connect the power:

- Plug the power cord into the **AC IN** jack on the back of your TV, then plug the other end of the cord into a power outlet.

Cautions

- Make sure that you use the correct type of power. See the label on your TV.
- If you do not intend to use your TV for an extended period of time, unplug the power cord from the power outlet.

Connecting an outdoor antenna

Antenna cables come in two types: 75 ohm and 300 ohm.

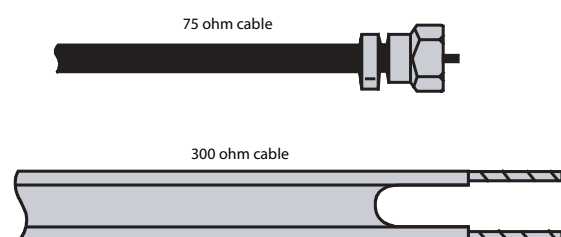

To connect an outdoor antenna:

- 1 Turn off your TV and all connected equipment.
- 2 If your antenna cable has a 75 ohm connector, connect the cable to the **ANTENNA/CABLE DIGITAL/ANALOG** jack on the back of your TV.
Or,
If your antenna cable has a 300 ohm connector, connect the cable to a 300-75 ohm adapter (not included), connect the adapter to a 75 ohm cable, then connect the other end of the 75 ohm connector to the **ANTENNA/CABLE DIGITAL/ANALOG** jack on the back of your TV.

- 3 Connect the other end of the cable to the antenna jack.

Connecting an indoor antenna

To connect an indoor antenna:

- 1 Turn off your TV and all connected equipment.
- 2 Connect a dual-telescoping dipole antenna (not included) to the **ANTENNA/CABLE DIGITAL/ANALOG** jack on the back of your TV.

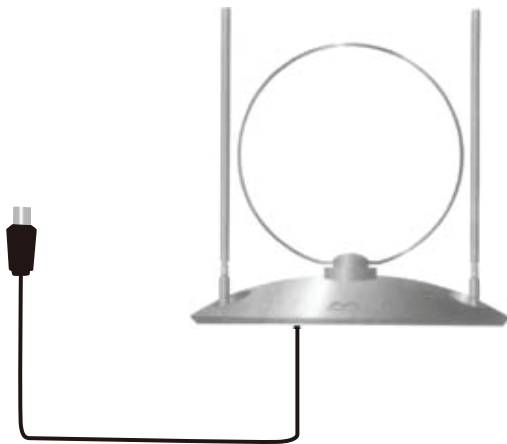

Note

Distance from the transmitting source, a man-made shelter, or natural atmospheric conditions might influence the reception, which is not related to antenna performance.

Connecting cable TV

Your TV has a 75 ohm jack for connecting cable TV. Some cable TV providers scramble the signals for "premium" (pay) channels. To view these channels, you need a converter/descrambler box.

If you do not require a converter/descrambler box, you can connect your cable TV directly to your TV. For more information, see "No converter/descrambler box" on page 10.

If you require a converter/descrambler box, you can connect your cable TV using an RF switch (not included). For more information about connecting a converter/descrambler box, see "With converter/descrambler box" on page 10 and contact your cable TV provider.

You can also connect cable TV using an HDMI, component video, S-Video, or AV connection, depending on your cable box. For more information, see "Connecting cable TV via a cable TV box" on page 11.

No converter/descrambler box

To connect cable TV without a converter/descrambler box:

- 1 Connect one end of a 75 ohm cable to the coaxial jack on the back of your TV.

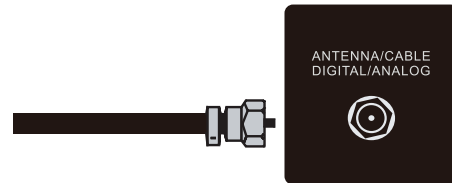

- 2 Connect the other end of the cable to the cable TV wall outlet.

With converter/descrambler box

If your cable box descrambles only some channels (such as premium channels), you need a two-way splitter, an RF (A/B) switch, and four lengths of antenna cable. The two-way splitter and RF switch are not provided.

To connect cable TV with a converter/descrambler box:

- Use the following illustration as a guide to connect a converter/descrambler box.

Set the RF switch to the **A** position to tune to unscrambled channels using your TV remote control. Set the RF switch to the **B** position to watch scrambled channels using the converter/descrambler controls.

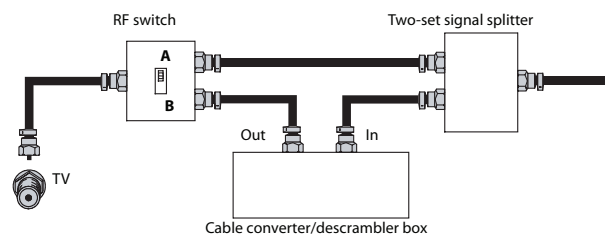

Connecting cable TV via a cable TV box

- 1 Connect the incoming cable from the cable wall jack to the cable-in jack on the cable box.
- 2 Depending on the jacks available on the cable box, connect a cable from the outgoing jacks on the cable box to the corresponding jacks on the back of your TV. The connection can be to the cable-out, HDMI, component video, S-Video, or AV jack.

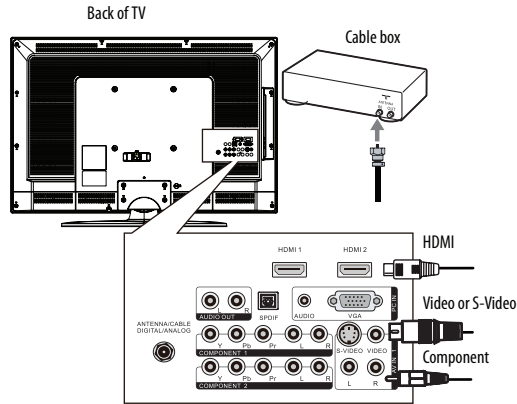

- 3 If you use a component video, S-Video, or AV cable, connect an audio cable to the corresponding jacks on the back of your TV and on the cable box.

Connecting satellite TV via a satellite TV box

To connect satellite TV:

- 1 Connect the incoming cable from the satellite wall jack to the satellite-in jack on the satellite box.
- 2 Depending on the jacks available on the satellite TV receiver (set-top box), connect a cable from the outgoing jacks on the satellite box to the corresponding jacks on the back of your TV. The connection can be to the HDMI, component video, S-Video, or AV jack.

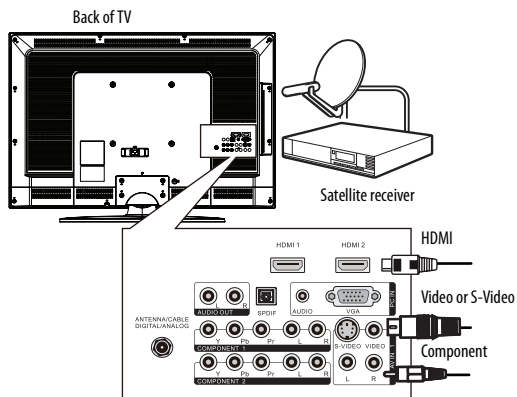

- 3 If you use a component video, S-Video, or AV cable, connect an audio cable to the corresponding jacks on the back of your TV and on the satellite box.

Connecting a VCR

To connect a VCR:

- 1 Connect an AV cable to the **AV IN 1 VIDEO** and **AV IN 1 L** and **R** audio jacks on the back of your TV.

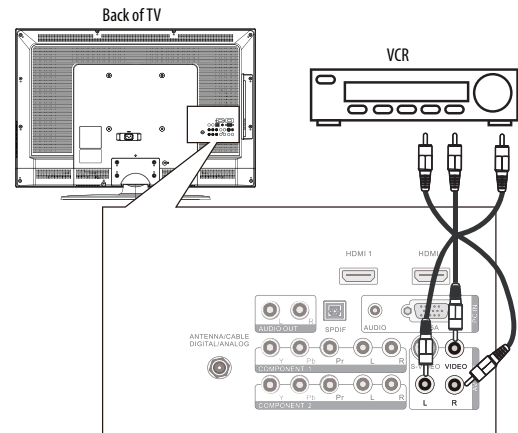

- 2 Connect the other end of the cable to the **VIDEO OUT** and **AUDIO OUT** jacks on the VCR.

Note

If a device is connected to the **S-VIDEO** jack, the **S-VIDEO** jack controls the **AV IN 1 L** and **R** jacks. To assign the audio jacks to the **AV IN 1 VIDEO** jack, unplug the S-Video device.

- 3 Turn on your TV, then turn on the VCR.
- 4 Press **INPUT** to open the *Source List*, then press **▲** or **▼** to select **AV1**.
- 5 Insert a videotape into the VCR, then press **PLAY**.

Connecting a camcorder or game console

To connect a camcorder or game console:

- 1 Connect an AV cable to the **AV IN 2 VIDEO** and **AV IN 2 L** and **R** audio jacks on the side of your TV.

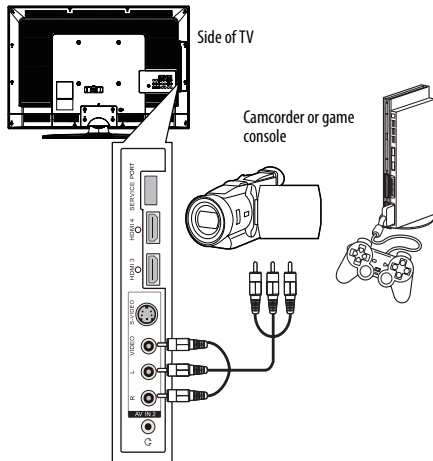

- 2 Connect the other end of the cable to the **VIDEO OUT** and **AUDIO OUT** jacks on the camcorder or game console.
- 3 Turn on your TV, then turn on the camcorder or game console.
- 4 Press **INPUT** to open the *Source List*, then press **▲** or **▼** to select **AV2**.

Note

If a device is connected to the **S-VIDEO** jack, the **S-VIDEO** jack controls the **AV IN 2 L** and **R** audio jacks.

To assign the audio jacks to the **AV IN 2 VIDEO** jack, unplug the S-Video device.

Connecting an HDMI device

You can connect an HDMI device to the **HDMI 1** or **HDMI 2** jack on the back of your TV or to the **HDMI 3** or **HDMI 4** jack on the side of your TV.

To connect an HDMI device to the back of your TV:

- 1 Connect an HDMI cable to the **HDMI 1** or **HDMI 2** jack on the back of your TV and to the **HDMI OUT** jack on the HDMI device.

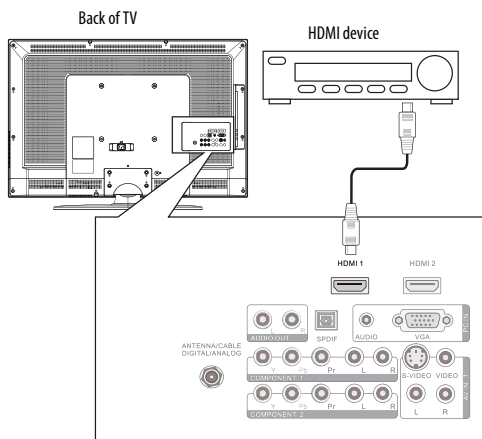

- 2 Turn on your TV, then turn on the HDMI device.
- 3 Press **INPUT** to open the *Source List*, then press **▲** or **▼** to select **HDMI 1** or **HDMI 2**.

Note

You can connect a DVI device to the **HDMI 1** jack on the back of your TV using an HDMI-to-DVI adapter. Next connect an audio cable to the **PC IN AUDIO** jack and to the audio out jack on the DVI device. You cannot connect a DVI device to the **HDMI 2** jack on the back of your TV.

To connect an HDMI device to the side of your TV:

- 1 Connect an HDMI cable to the **HDMI 3** or **HDMI 4** jack on the side of your TV and to the **HDMI OUT** jack on the HDMI device.

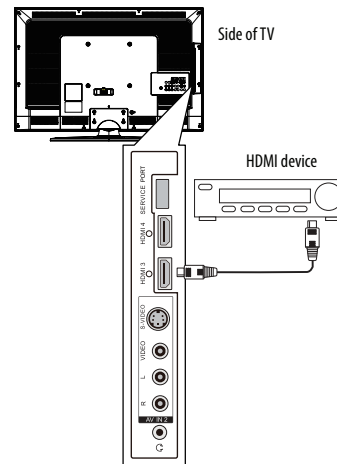

- 2 Turn on your TV, then turn on the HDMI device.
- 3 Press **INPUT** to open the *Source List*, then press **▲** or **▼** to select **HDMI 3** or **HDMI 4**.

Note

You cannot connect a DVI device to the **HDMI 3** or **HDMI 4** jack on the side of your TV.

Connecting a component video device

To connect a component video device:

- 1 Connect a component video cable to the **COMPONENT 1** or **COMPONENT 2 Y, Pb, and Pr** jacks on the back of your TV and to the **COMPONENT OUT** video jacks on the component video device.

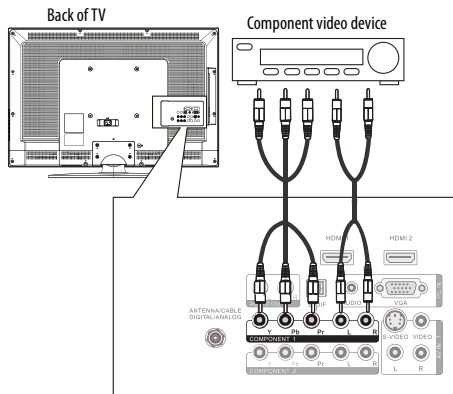

- 2 Connect an audio cable to the **COMPONENT 1** or **COMPONENT 2 L and R** audio jacks on the back of your TV and to the **COMPONENT AUDIO OUT** jacks on the component video device.
- 3 Turn on your TV, then turn on the component video device.
- 4 Press **INPUT** to open the *Source List*, then press **▲** or **▼** to select **Component 1** or **Component 2**.

Connecting an S-Video device

To connect an S-Video device to the back of your TV:

- 1 Connect an S-Video cable to the **AV IN 1 S-VIDEO** jack on the back of your TV and to the **S-VIDEO OUT** jack on the S-Video device.

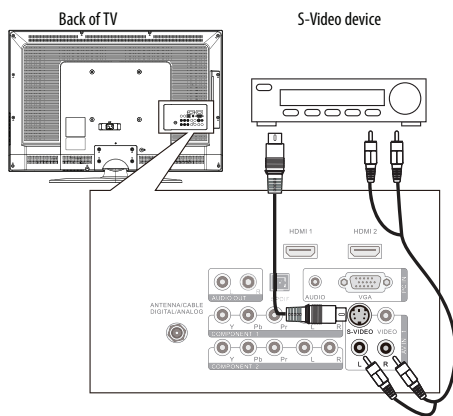

- 2 Connect an audio cable to the **AV IN 1 L and R** jacks on the back of your TV and to the corresponding audio out jacks on the S-Video device.
- 3 Turn on your TV, then turn on the S-Video device.

- 4 Press **INPUT** to open the *Source List*, then press **▲** or **▼** to select **AV1**.

To connect an S-Video device to the side of your TV:

- 1 Connect an S-Video cable to the **AV IN 2 S-VIDEO** jack on the side of your TV and to the **S-VIDEO OUT** jack on the S-Video device.

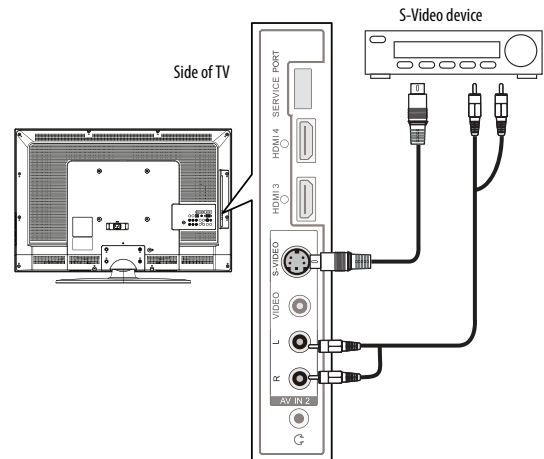

- 2 Connect an audio cable to the **AV IN 2 L and R** audio jacks on the side of your TV and to the corresponding audio out jacks on the S-Video device.
- 3 Turn on your TV, then turn on the S-Video device.
- 4 Press **INPUT** to open the *Source List*, then press **▲** or **▼** to select **AV2**.

Connecting a computer

Note

If the computer has an HDMI jack, you can connect it to an HDMI jack on your TV.

To connect a computer:

- 1 Connect a VGA cable to the **PC IN VGA** jack on the back of your TV and the **VGA** jack on the computer.

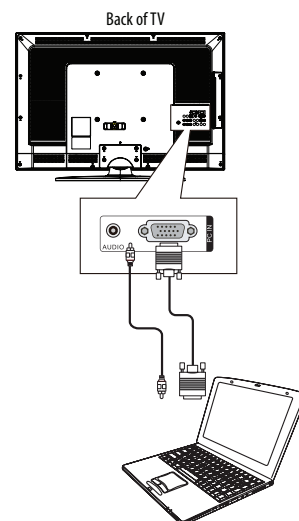

- 2 Connect an audio cable to the **PC IN AUDIO** jack on the back of your TV and to the **AUDIO OUT** jack on the computer.
- 3 Turn on your TV, then turn on the computer.
- 4 Press **INPUT** to open the *Source List*, then press **▲** or **▼** to select **VGA**.

Note

When the computer enters standby mode, your TV turns off. If your TV does not turn on when you "wake" your computer, press **⏻** (power) on your TV or remote control.

Connecting headphones

To connect headphones:

- Plug headphones into the **🎧** jack on the side of your TV.

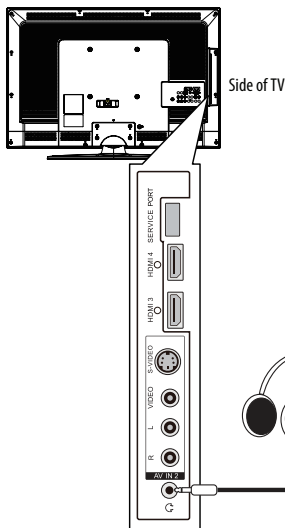

Note

When headphones are plugged in, the sound from your TV's speakers is muted.

Connecting a digital audio amplifier

To connect a digital audio amplifier:

- Connect a digital audio cable to the **SPDIF** jack on the back of your TV and to the digital audio jack on the amplifier.

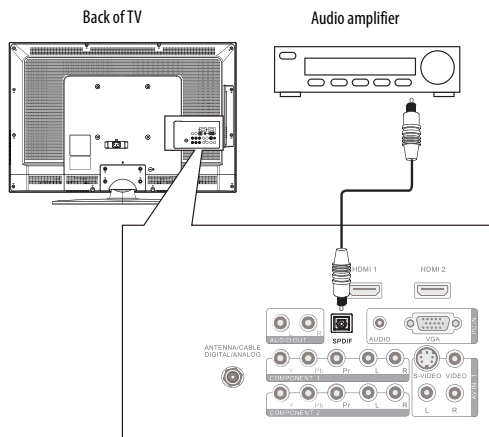

Connecting an analog audio amplifier

To connect an analog audio amplifier to your TV:

- Connect a standard audio cable to the **AUDIO OUT L** and **R** audio jacks on the back of your TV and to the **AUDIO IN** jacks on the amplifier.

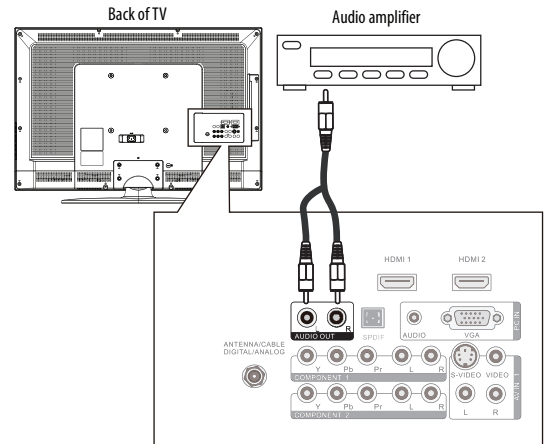

Turning on your TV for the first time

The first time you turn on your TV, the Setup Wizard opens. The Setup Wizard guides you through setting up basic settings including the menu language, TV signal source, and the channel list.

To set up your TV:

- 1 Make sure that you have:
 - Installed the remote control batteries. (See page 8 for details).
 - Connected an antenna, cable TV, or satellite TV. (See pages 9 through 11 for details.)
 - Connected the power cord. (See page 9 for details.)
- 2 Press **⏻** (power) to turn on your TV. The *Choose your menu Language* screen opens.

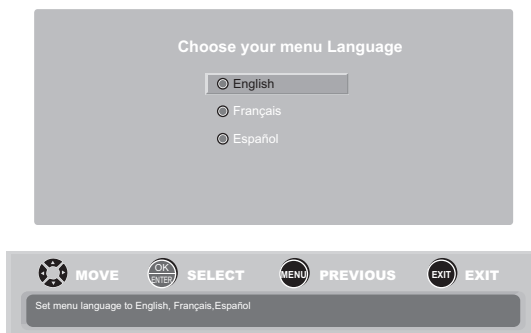

- 3 Press **▲** or **▼** to highlight **English, Français, or Español**, then press **OK/ENTER** to confirm your selection. The *Choose your TV source* screen opens.

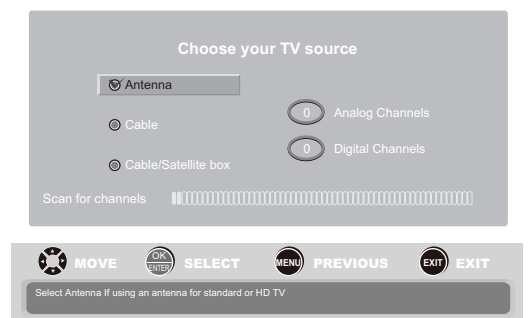

- 4 Press **▲** or **▼** to highlight **Antenna, Cable, or Cable/Satellite box** (if your cable TV uses a box, select **Cable/Satellite box**), then press **OK/ENTER**. If you chose **Antenna or Cable**, your TV automatically starts scanning for channels available in your viewing area. If you chose **Cable/Satellite box**, your TV does not need to scan for channels.

When the scan is complete, the Setup Wizard closes automatically.

Note

You can change the menu language or scan for channels at a later date. For more information, see "Selecting the menu language" on page 29 or "Automatically scanning for channels" on page 19.

Understanding the basics

Note

Unless otherwise noted, all tasks in this section are based on using the remote control.

Turning your TV on or off

To turn your TV on and off:

- 1 Make sure that the power cord is connected to your TV and a power outlet.
- 2 Press **⏻** (power) to turn on your TV. The power indicator LED turns blue.
- 3 Press **⏻** (power) again to turn off your TV. Your TV enters Standby mode and the power indicator LED turns red.

Warning

When your TV is off, power still flows into it. To disconnect power, unplug the power cord.

Note

If your TV does not detect a signal and you do not press any button for 15 minutes, your TV goes into Standby mode automatically.

Selecting the video input source

To select the video input source:

- 1 With your TV turned on, press **INPUT**. The *Source List* opens.

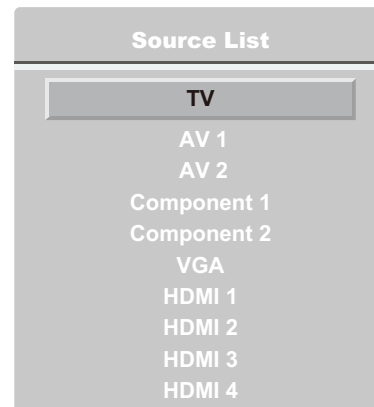

- 2 Press **▲** or **▼** to highlight the video input source you want. You can select:

- **TV**
- **AV 1**
- **AV 2**
- **Component 1**
- **Component 2**
- **VGA**
- **HDMI 1**
- **HDMI 2**
- **HDMI 3**
- **HDMI 4**

- 3 Press **OK/ENTER**.

You can also press a direct input button to select the video input source.

- Press **TV** to select **TV**.

- Press **VIDEO** once to select **AV 1** (for **AV1 IN VIDEO** or **AV1 IN S-VIDEO**).
- Press **VIDEO** twice to select **AV 2**.
- Press **COMP** once to select **Component 1**.
- Press **COMP** twice to select **Component 2**.
- Press **HDMI** once to select **HDMI 1**.
- Press **HDMI** twice to select **HDMI 2**.
- Press **HDMI** three times to select **HDMI 3**.
- Press **HDMI** four times to select **HDMI 4**.

Settings menu



On-screen menu overview

Picture menu

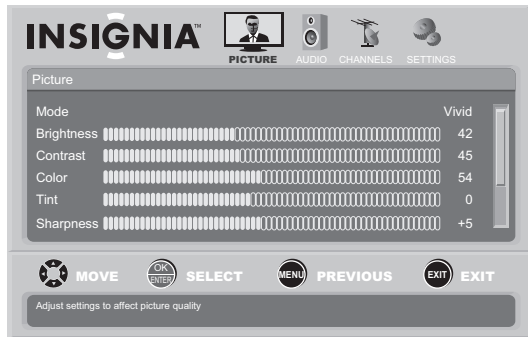

Audio menu

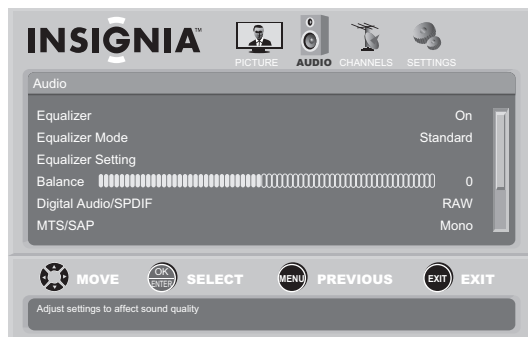

Note

The *Audio* menu will look slightly different when the **Equalizer** setting is changed to **Off**.

Channels menu



Navigating the menus

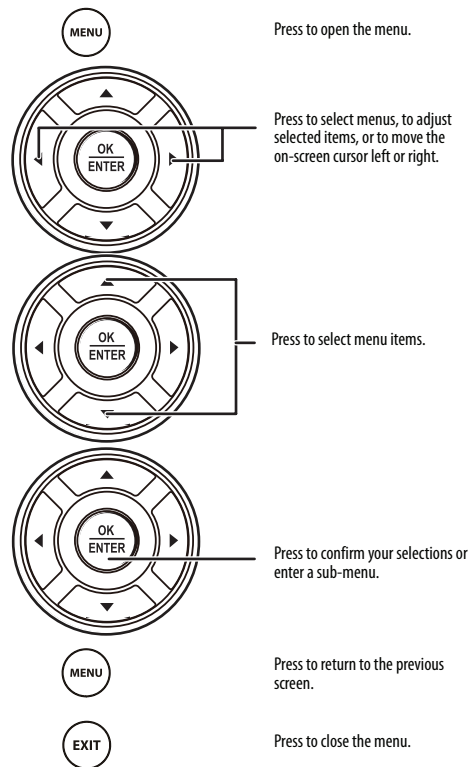

Selecting a channel

To select a channel:

- Press **CH ▲** or **CH ▼** to go to the next higher or lower channel in the channel list.
- Press the number buttons to directly select a channel. For example, if you want to view channel 83, press **8**, then press **3**.
- Press **RECALL** to go to the last viewed channel.
- Press the number buttons for a main DTV channel, press **—**, then press the number for a DTV sub-channel to go to a digital sub-channel. For example, to go to sub-channel 1 of main channel 83, press **8**, **3**, **—**, then **1**.

Note

You can press the number buttons to go to a channel that was skipped in the channel scanning.

Adjusting the volume

To adjust the volume:

- Press **VOL –** or **VOL +** to decrease or increase the volume.
- Press **MUTE** to turn off the sound. Press **MUTE** again to turn the sound back on.

Displaying additional information

To display additional information:

- Press **INFO**. Your TV displays status information, such as the channel number, channel name (if available), signal source, program description, and DTV signal strength.

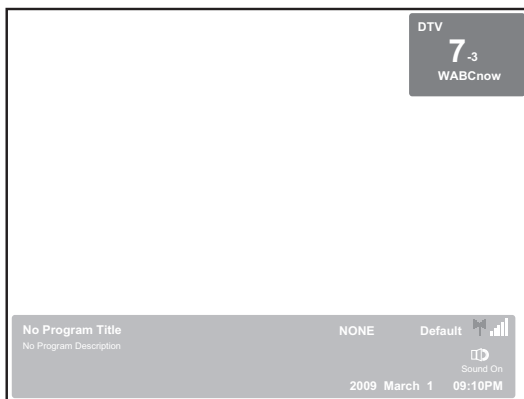

- Press **GUIDE** to show the digital program guide, which may show current channel name, program name, time, rating, and summaries, depending on the information provided by the broadcaster.

Adjusting the picture

Note

Unless otherwise noted, all tasks in this section are based on using the remote control.

Adjusting the TV picture

To adjust the picture:

- 1 Press **MENU**. The on-screen menu opens with the *Picture* menu displayed.

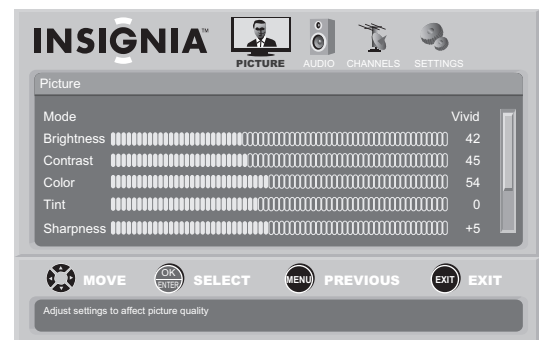

- 2 Press **▼** to highlight an option, then press **OK/ENTER** to access the sub-menu. You can select:
 - **Mode**—Selects the picture mode. You can select **Vivid**, **Standard**, **Energy Savings**, **Theater**, **Sports**, or **Custom**.
 - **Brightness**—Adjusts the picture brightness.
 - **Contrast**—Adjusts the contrast.
 - **Sharpness**—Adjusts the sharpness.
 - **Color**—Adjusts the color saturation.
 - **Tint**—Adjusts the picture tint.
 - **Advanced Video**—Opens the *Advanced Video* menu. For more information, see “Adjusting Advanced Video settings” on page 18.
 - **Reset Picture Settings**—Resets all picture settings to the factory defaults. When you select this option, a confirmation box opens. Press **◀** or **▶** to select **Yes** or **No**, then press **OK/ENTER** to confirm.
- 3 Press **◀** or **▶** to modify a scale or to move from left to right to make a choice in a submenu. Press **▲** or **▼** to move up or down when selecting from a list of choices in a submenu.
- 4 Press **MENU** to go to the previous menu or **EXIT** to close the menu.

Note

- You may need to scroll down to see all the options.
- If you adjust **Brightness**, **Contrast**, **Color**, **Tint**, or **Sharpness** in **Vivid**, **Standard**, **Energy Savings**, **Theater**, or **Sports** mode, your TV switches to **Custom** mode automatically.

Adjusting Advanced Video settings

To adjust advanced video settings:

- 1 On the *Picture* menu, press ▲ or ▼ to highlight **Advanced Video**, then press **OK/ENTER** or ►. The *Advanced Video* menu opens.

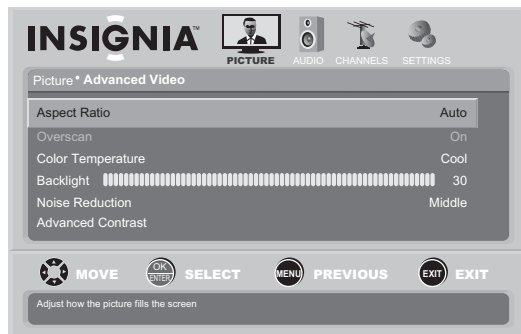

- 2 Press ▼ to highlight an option, then press **OK/ENTER** to access the sub-menu. You can select:
 - **Aspect Ratio**—Selects the aspect ratio. You can select **Normal**, **Zoom**, **Wide**, **Cinema**, or **Auto**. **Auto** is only available under TV mode and when **Auto Zoom** on the *Channels* menu is set to **On**. In VGA mode or HDMI mode when a computer is connected to the HDMI jack, only **Wide** and **Normal** are available.
 - **Color temperature**—Selects the color temperature to change the overall color of the picture. You can select **Cool**, **Normal**, or **Warm**.
 - **Backlight**—Controls the overall brilliance of the screen. You can adjust the backlight through a range of 0~30.
 - **Noise Reduction**—Controls video noise. You can select **Off**, **Low**, **Middle**, or **High**.
 - **Advanced Contrast**—When you see the pop-up menu, set **Adaptive Contrast** to **On** to adjust picture detail and brightness automatically and/or set **Dynamic Contrast** to **On** to automatically adjust the contrast between the light and dark areas of the picture.
- 3 Press ◀ or ▶ to modify a scale or to move from left to right to make a choice in a submenu. Press ▲ or ▼ to move up or down when selecting from a list of choices in a submenu.
- 4 Press **MENU** to go to the previous menu or **EXIT** to close the menu.

Freezing the picture

To freeze the picture:

- Press **FREEZE**. Press again to unfreeze the picture.

Caution

Do not freeze the picture for long periods of time. You may damage your TV's screen.

Adjusting the sound

Note

Unless otherwise noted, all tasks in this section are based on using the remote control.

Adjusting the sound

To adjust the sound:

- 1 Press **MENU**. The on-screen menu opens with the *Picture* menu displayed.

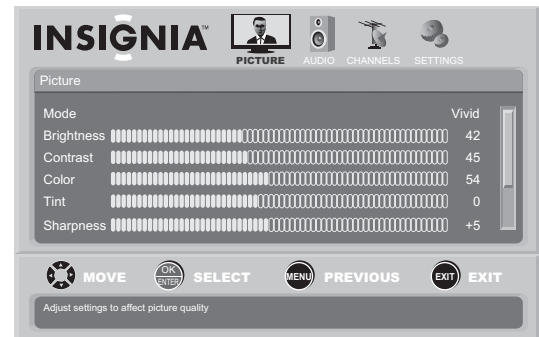

- 2 Press ◀ or ▶ to select **AUDIO**. The *Audio* menu opens.

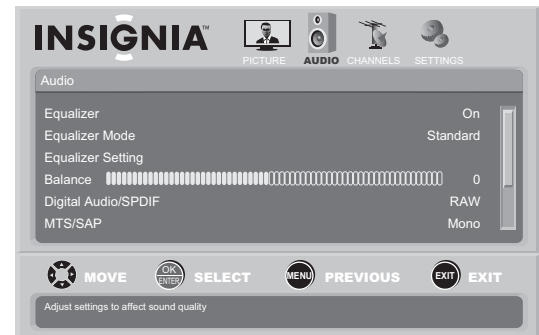

- 3 Press ▼ to highlight **Equalizer**, then press **OK/ENTER** to open the submenu
- 4 Press ▲ or ▼ to select **On** or **Off**, then press **OK/ENTER** to return to the Audio menu. The **Equalizer** setting affects other settings you can adjust.
- 5 Press ▼ to highlight an option, then press **OK/ENTER** to access the sub-menu. You can select:
 - **Equalizer (set to Off)**—You can adjust the following options by pressing ▲ or ▼ to select the option:
 - **Treble**—Adjust high frequency sound.
 - **Bass**—Adjust low frequency sound.
 - **SRS TruSurround HD**—Provides the ultimate home theater sound solution. You can select **On** or **Off**.

Note

If **SRS TruSurround HD** is set to **On** and you set **Equalizer** to **On** again, **SRS TruSurround HD** will be set to **Off** automatically.

- **Equalizer (set to On)**—You can adjust the following options by pressing ▲ or ▼ to select the option:
 - **Equalizer Mode**—Selects the equalizer mode. You can select **Custom**, **Standard**, **Theater**, **Music**, and **News**. Press **OK/ENTER** after you make your selection.
 - **Equalizer Settings**—Set the equalizer frequency. You can select **120Hz**, **500Hz**, **1.5kHz**, **5kHz**, or **10kHz**. Press ▲ or ▼ to adjust the settings. Press ◀ or ▶ to switch between columns. Press **MENU** to confirm the settings.

You can adjust the following options regardless of the **Equalizer** setting:

- **Balance**—Adjusts the sound between the left and right speakers.
 - **Digital Audio/SPDIF**—Sends digital audio to an external audio system. You can select **RAW** or **PCM**.
 - **MTS/SAP**—Selects the sound mode (for analog channel only).
 - **Mono**—Produces a clearer sound if stereo sound is difficult to hear.
 - **Stereo**—Produces dynamic stereo sound for sporting events and concerts.
 - **SAP**—Selects a second language, weather, or added commentary, if available.
 - **Audio Language**—Selects the audio language based on the languages supported by a DTV channel.
 - **Auto Volume**—Automatically adjusts volume to be consistent across programs and channels. You can select **On** or **Off**.
 - **Reset Audio Settings**—Reset all audio settings to factory defaults. When you select this option, a confirmation box opens. Press ◀ or ▶ to select **Yes** or **No**, then press **OK/ENTER** to confirm.
- 6 Press ◀ or ▶ to modify a scale or to move from left to right to make a choice in a submenu. Press ▲ or ▼ to move up or down when selecting from a list of choices in a submenu.)
 - 7 Press **MENU** to go to the previous menu or **EXIT** to close the menu.

Playing TV audio only

When watching TV, you can turn off the TV picture and listen to the audio only.

To play TV audio only:

- 1 Press **MENU**. The on-screen menu opens with the *Picture* menu displayed.

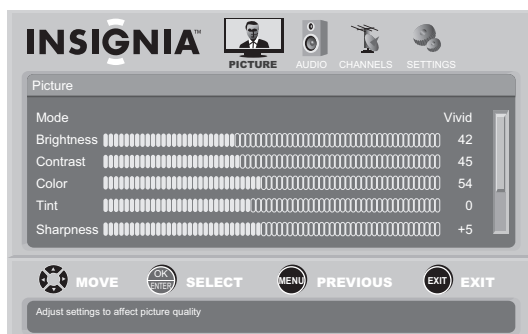

- 2 Press ◀ or ▶ to select **CHANNELS**. The *Channels* menu opens.

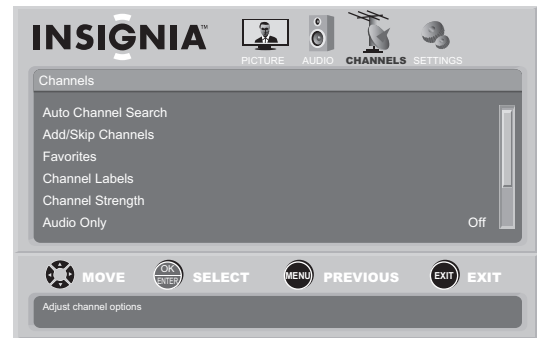

- 3 Press ▼ to highlight **Audio Only**, then press **OK/ENTER** or ▶ to access the sub-menu.
- 4 Press ▲ or ▼ to select **On** or **Off**.

Note

- It takes about 3 seconds after the menu closes and the picture disappears before the audio plays.
- **Audio Only** works only when the input source is TV and your TV is receiving a broadcast signal.
- To exit **Audio Only** mode, press any button. When you exit **Audio Only** mode, the **Audio Only** option is automatically reset to Off.

Changing channel settings

Note

Unless otherwise noted, all tasks in this section are based on using the remote control.

Automatically scanning for channels

When you scan for channels, your TV searches for channels with signals and stores the channel information in the channel list. When you press **CH ▲** or **CH ▼**, your TV goes to the next or previous channel in the channel list and skips the channels that do not have signals.

If the TV signal source changes, for example you change from an outdoor antenna to cable TV (no box), you need to scan for channels.

To automatically scan for channels:

- 1 Press **MENU**. The on-screen menu opens with the *Picture* menu displayed.

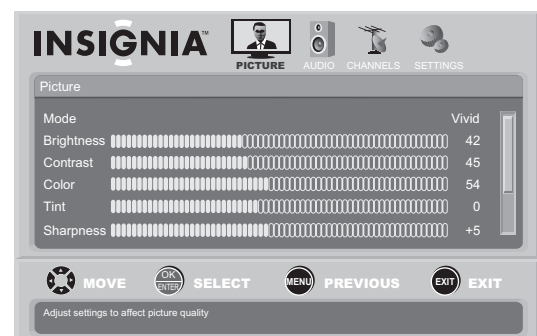

- Press **◀** or **▶** to select **CHANNELS**. The *Channels* menu opens.

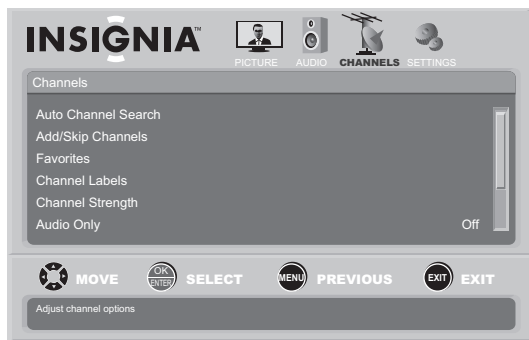

- Press **▼** to highlight **Auto Channel Search**, then press **OK/ENTER** or **▶** to open the *Auto Channel Search* screen.

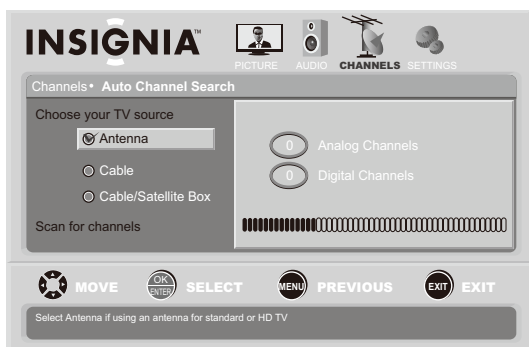

- Press **▼** to highlight **Antenna, Cable, or Cable/Satellite Box**, then press **OK/ENTER** to start the scan. You can see the search progress and how many channels are found in the on-screen menu. After the scan is complete, the menu closes and your TV tunes to the first channel in the list.

Note

You can press **EXIT** to stop the search. If you select **Cable/Satellite Box**, your TV will not scan for channels because the available channels are provided by the box. Press **EXIT** to close the menu.

Hiding channels

You can hide channels in the channel list. When you press **CH ▲** or **CH ▼**, your TV will skip the hidden channels. You can still tune to a hidden channel by pressing the number buttons for the channel.

To hide channels:

- Press **MENU**. The on-screen menu opens with the *Picture* menu displayed.

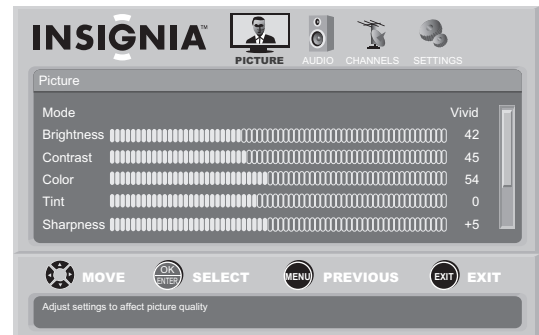

- Press **◀** or **▶** to select **CHANNELS**. The *Channels* menu opens.

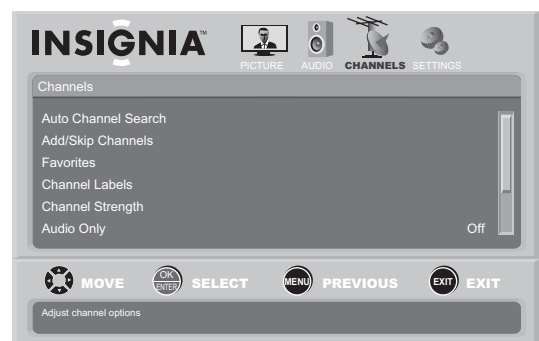

- Press **▼** to highlight **Add/SKIP**, then press **OK/ENTER** or **▶** to open the *Channel Lists* screen.



- Press **◀▶▲** or **▼** to highlight the channel you want to hide, then press **OK/ENTER** to uncheck the highlighted channel. You can add a channel to the list by highlighting a channel and checking it.

- Repeat Step 4 to hide additional channels.
- Press **MENU** to return the previous menu, or press **EXIT** to close the menu.

Note

Depending on how many channels are in the channel list, you may need to press **▲** or **▼** to scroll to the next or previous page of channels.

- Repeat Step 4 to add additional channels.
- Press **MENU** to return the previous menu, or press **EXIT** to close menu.

Note

Depending on how many channels are in the *Favorites* list, you may need to press **▲** or **▼** to scroll to the next or previous page of channels.

Setting up a favorite channel list

To set up a favorite channel list:

- Press **MENU**. The on-screen menu opens with the *Picture* menu displayed.

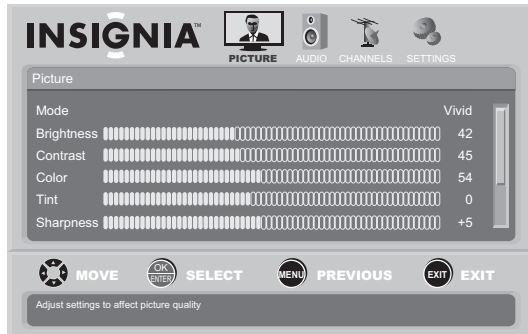

- Press **◀** or **▶** to select **CHANNELS**. The *Channels* menu opens.

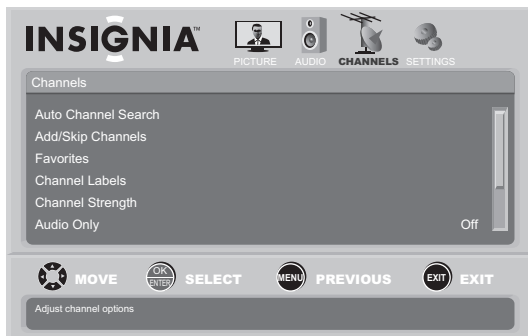

- Press **▼** to highlight **Favorites**, then press **OK/ENTER** or **▶** to open the *Favorites* screen.

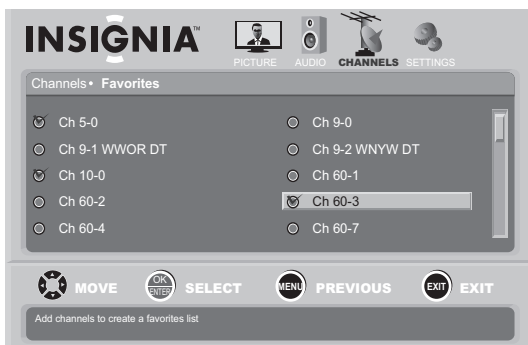

- Press **◀▶▲▼** to highlight the channel you want to add to the *Favorites* list, then press **OK/ENTER** to check the highlighted channel. You can remove a channel from the list by highlighting the channel and unchecking it.

Viewing a favorite channel

To view a favorite channel:

- Press **FAV** to open the *Favorites* list.

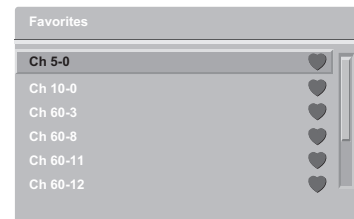

- Press **▲** or **▼** to highlight the channel you want to watch, then press **OK/ENTER** to tune to the channel.

- Press **EXIT** to close the *Favorites* list.

Note

Depending on how many channels are in the *Favorites* list, you may need to press **▲** or **▼** to scroll to the next or previous page of channels.

Adding or changing a channel label

To add or change a channel label:

- Press **MENU**. The on-screen menu opens with the *Picture* menu displayed.

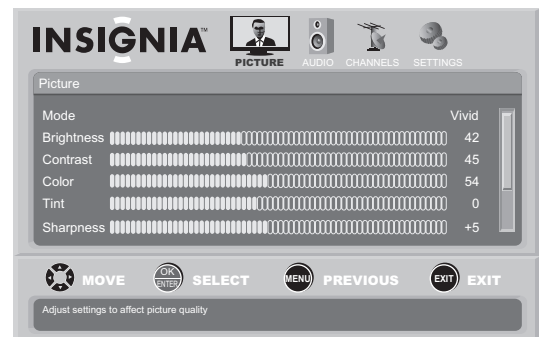

- 2 Press **◀** or **▶** to select **CHANNELS**. The *Channels* menu opens.

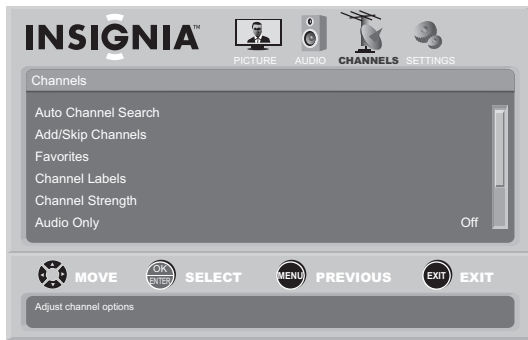

- 3 Press **▼** to highlight **Channel Labels**, then press **OK/ENTER** or **▶** to open the *Channel Labels* screen.



- 4 Press **▲** or **▼** to select the channel you want to add a label to or change the label for, then press **▶** to move the cursor to label selection field.
- 5 Press **▲** or **▼** to select a letter, then press **▶** to go to the next letter. Repeat this step to add additional letters. You can add as many as 11 letters.
- 6 Press **OK/ENTER** to confirm the label.
- 7 Press **◀** or **▶** to check **Yes** or **No**, then press **OK/ENTER** to confirm.
- 8 Press **MENU** to go to the previous menu, or press **EXIT** to close the menu.

Checking the DTV signal strength

To check the DTV signal strength:

- 1 Press **MENU**. The on-screen menu opens with the *Picture* menu displayed.

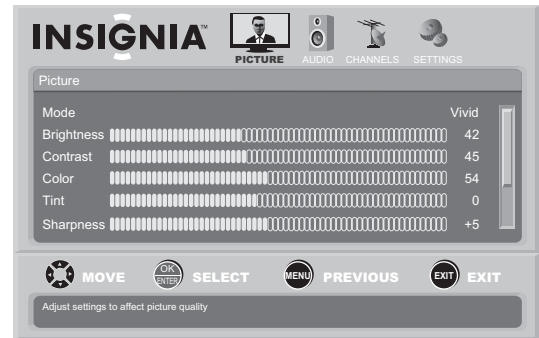

- 2 Press **◀** or **▶** to select **CHANNELS**. The *Channels* menu opens.

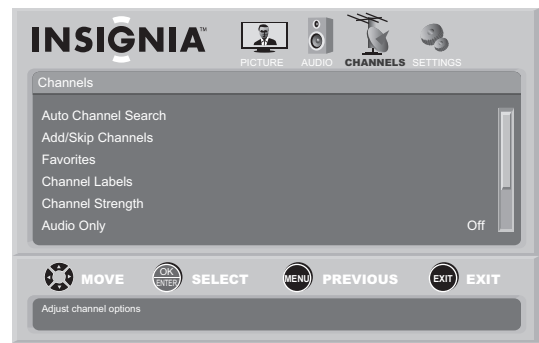

- 3 Press **▼** to highlight **Channel Strength**, then press **OK/ENTER** or **▶** to open the DTV signal meter.

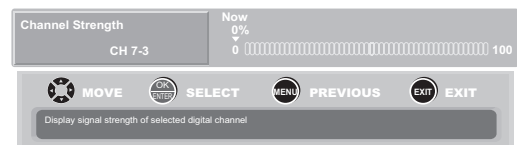

- 4 Press **MENU** to go to the previous menu, or press **EXIT** to close the menu.

Note

When you are tuned to a DTV channel, you can press **INFO** to see the DTV signal strength.

Setting parental controls

Note

Unless otherwise noted, all tasks in this section are based on using the remote control.

Setting or changing the password

Your TV has a V-chip that lets you control the type of programs your children can watch. Parental controls include two ratings: MPAA (based on age) and TV Parental Guidelines (based on content and age). A TV program may have an MPAA or TV Parental Guidelines rating, so you should set controls for both ratings.

Before you can select ratings, you need to set up a parental controls password.

To set up a password:

- 1 Press **MENU**. The on-screen menu opens with the *Picture* menu displayed.

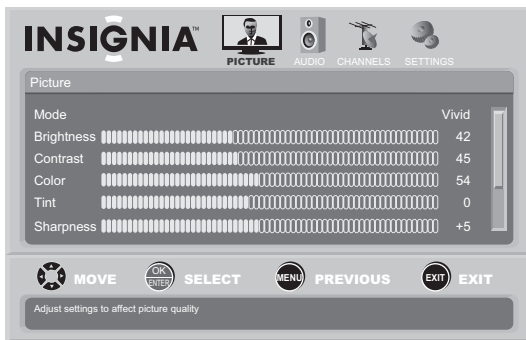

- 2 Press **◀** or **▶** to select **SETTINGS**. The *Settings* menu opens.



- 3 Press **▼** to highlight **Parental Controls**, then press **OK/ENTER** or **▶**. The *Enter Password* screen opens.

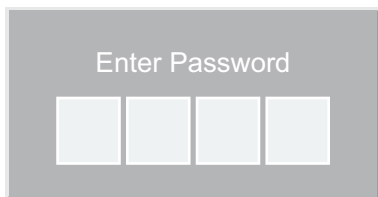

- 4 Press the number buttons to enter the password. If you have not set a password, enter **0000**. The *Parental Controls* menu opens.



- 5 Press **▲** or **▼** to highlight **Change Password**, then press **OK/ENTER** or **▶**. The *Enter New Password* screen opens.

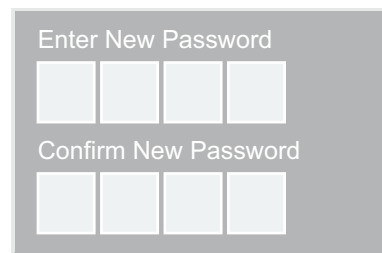

- 6 Press the number buttons to enter the new password, then enter the new password again.

Note

Write down your password and save it for future use. If you forget your password, enter **9999** as the password. This password always remains valid for resetting your password.

Setting parental control levels

To set parental control levels:

- 1 Press **MENU**. The on-screen menu opens with the *Picture* menu displayed.

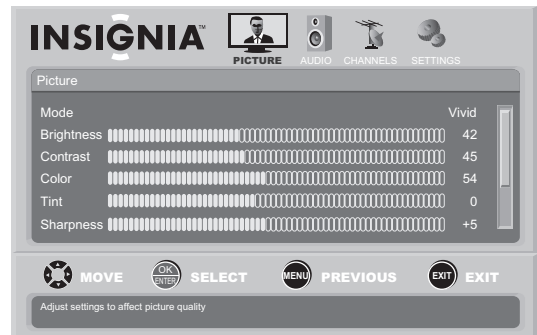

- 2 Press ◀ or ▶ to select **SETTINGS**. The *Settings* menu opens.



- 3 Press ▼ to highlight **Parental Controls**, then press **OK/ENTER** or ▶. The *Enter Password* screen opens.

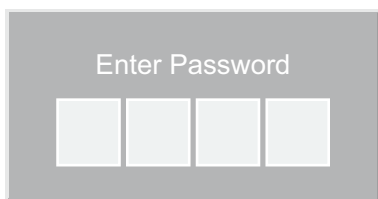

- 4 Press the number buttons to enter the password. If you have not set a password, enter **0000**. The *Parental Controls* menu opens.



- 5 Press ▲ or ▼ to highlight **USA Parental Locks** or **Canadian Parental Locks**, then press **OK/ENTER** or ▶ to open the *USA Parental Locks* or *Canadian Parental Locks* screen.

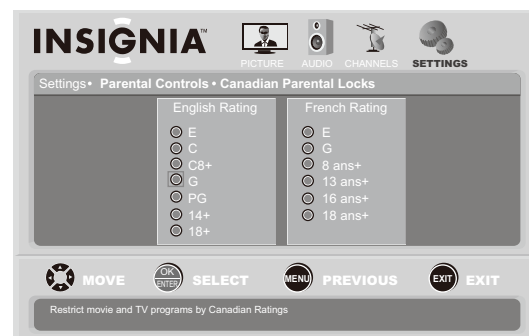
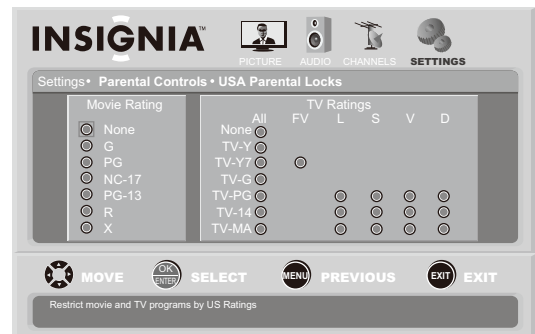

- 6 Press ◀ ▶ ▲ or ▼ to highlight a rating, then press **OK/ENTER** to block or unblock the rating. When you block a rating, that rating and all higher ratings are blocked.
- 7 Press **MENU** to return to the previous menu, or press **EXIT** to close the menu.

Note

When you first set parental controls, they take effect immediately.

If you have set parental controls then tune to a blocked channel or program, you are prompted to enter the password. After you enter the password, parental controls are tuned off.

You can press **P-LOCK** (or turn your TV off, then back on) to turn parental controls back on.

U.S. TV ratings

NONE	Not rated
TV-Y	All children
TV-Y7	Children over seven years of age
TV-G	General audiences
TV-PG	Parental guidance suggested
TV-14	Parents strongly cautioned
TV-MA	Mature audiences only

Some of the age-based TV Parental Guidelines ratings also have content-based ratings.

U.S. TV content ratings	
FV	Fantasy violence
L	Adult language.
S	Sexual situations.
V	Violence.
D	Sexually suggestive dialog.

U.S. movie (MPAA) ratings	
G	General audiences
PG	Parental guidance suggested
PG-13	Suitable for children 13 and older
R	Parental guidance suggested for children under 17
NC-17	Not suitable for children under 17
X	Adults only
N/A	Movie not rated.

Canadian English ratings	
E	Exempt programming
C	Children
C8+	Children over 8 years old
G	General audiences
PG	Parental guidance
14+	Over 14 years old
18+	Adult programming

Canadian French ratings	
E	Exempt programming
G	General audiences
8ans+	Over 8 years old
13ans+	Over 13 years old
16ans+	Over 16 years old
18ans+	Over 18 years old, only for adult viewing

Blocking unrated TV

To block unrated TV:

- 1 Press **MENU**. The on-screen menu opens with the *Picture* menu displayed.

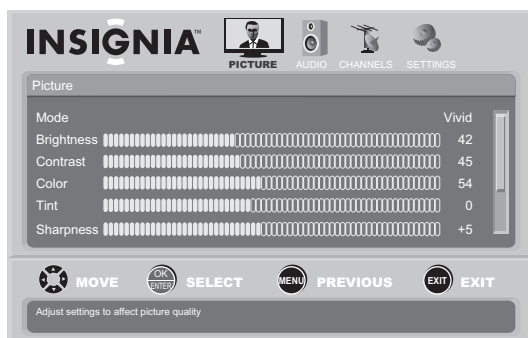

- 2 Press **◀** or **▶** to select **SETTINGS**. The *Settings* menu opens.



- 3 Press **▼** to highlight **Parental Controls**, then press **OK/ENTER** or **▶**. The *Enter Password* screen opens.

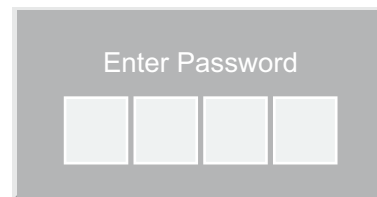

- 4 Press the number buttons to enter the password. If you have not set a password, enter **0000**. The *Parental Controls* menu opens.



- 5 Press **▼** to highlight **Block Unrated TV**, then press **OK/ENTER** or **▶** to access the sub-menu.
- 6 Press **▲** or **▼** to select **On** (blocks unrated TV) or **Off** (does not block unrated TV).
- 7 Press **MENU** to go to the previous menu or **EXIT** to close the menu.

Downloading rating information

To download rating information:

- 1 Press **MENU**. The on-screen menu opens with the *Picture* menu displayed.

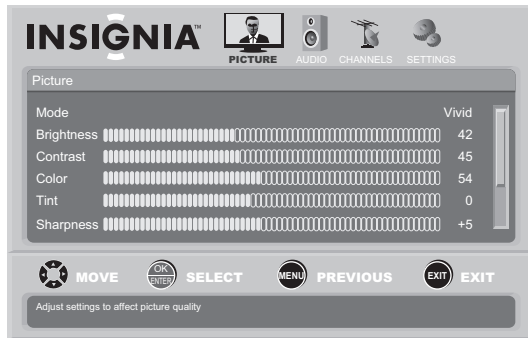

- 2 Press **◀** or **▶** to select **SETTINGS**. The *Settings* menu opens.



- 3 Press **▼** to highlight **Parental Controls**, then press **OK/ENTER** or **▶**. The *Enter Password* screen opens.

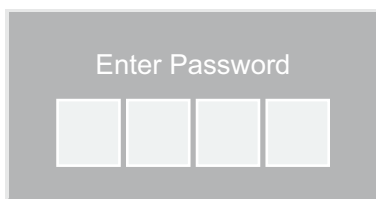

- 4 Press the number buttons to enter the password. If you have not set a password, enter **0000**. The *Parental Controls* menu opens.



- 5 Press **▲** or **▼** to scroll down the list of options and highlight **RRT5**.



- 6 Press **OK/ENTER** or **▶** to open the *RRT5* screen.
- 7 Press **▼** to highlight an option, then press **OK/ENTER** or **▶** to open the sub-menu.
- 8 Press **▲** or **▼** to select a rating.
- 9 Press **MENU** to go to the previous menu or **EXIT** to close the menu.

Note

If the program is broadcasted with RRT5 rating information, the information is downloaded automatically and can be used for parental controls. If the program is not broadcasted with RRT5 rating information, no information is downloaded.

Locking control buttons

You can lock the control buttons on the TV. When the buttons are locked, you can only operate the TV using the remote control.

To lock control buttons:

- 1 Press **MENU**. The on-screen menu opens with the *Picture* menu displayed.

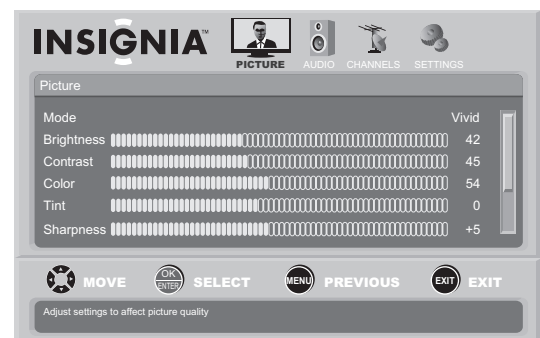

- 2 Press **◀** or **▶** to select **SETTINGS**. The *Settings* menu opens.



- Press **▼** to highlight **Parental Controls**, then press **OK/ENTER** or **▶**. The *Enter Password* screen opens.



- Press the number buttons to enter the password. If you have not set a password, enter **0000**. The *Parental Controls* menu opens.



- Press **▼** to highlight **Button Lock**, then press **OK/ENTER** or **▶** to access the sub-menu.
- Press **▲** or **▼** to select **On** or **Off**.
- Press **MENU** to go to the previous menu or **EXIT** to close the menu.

- Press **◀** or **▶** to select **SETTINGS**. The *Settings* menu opens.



- Press **▼** to highlight **Closed Caption**, then press **OK/ENTER** or **▶** to open the *Closed Caption* menu.

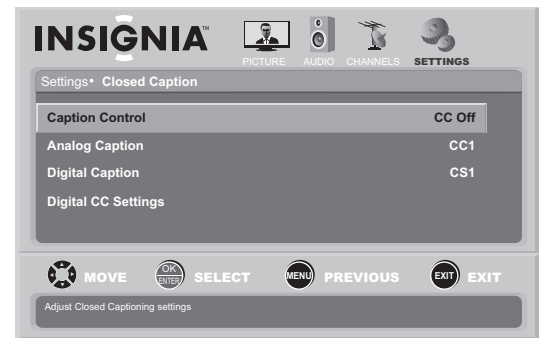

- Press **▲** or **▼** to highlight **Analog Caption** or **Digital Caption**, then press **OK/ENTER** or **▶** to open the sub-menu.
- Press **▲** **▼** **◀** or **▶** to select a setting.
- Press **MENU** to go to the previous menu or **EXIT** to close the menu.

Using closed captioning

Note

Unless otherwise noted, all tasks in this section are based on using the remote control.

Viewing closed captioning

To view closed captions:

- Press **CCD** to select **CC Off**, **CC On**, or **CC On When Mute**.

Selecting the closed captioning mode

To select the closed captioning mode:

- Press **MENU**. The on-screen menu opens with the *Picture* menu displayed.

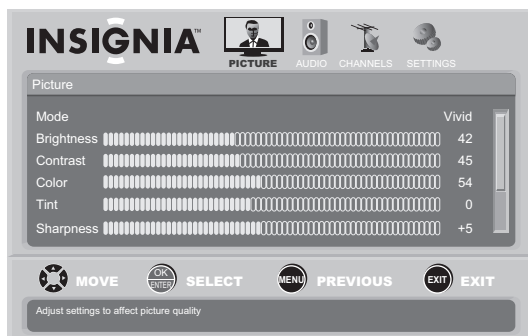

Customizing DTV closed captioning styles

To customize DTV closed captioning styles:

- Press **MENU**. The on-screen menu opens with the *Picture* menu displayed.

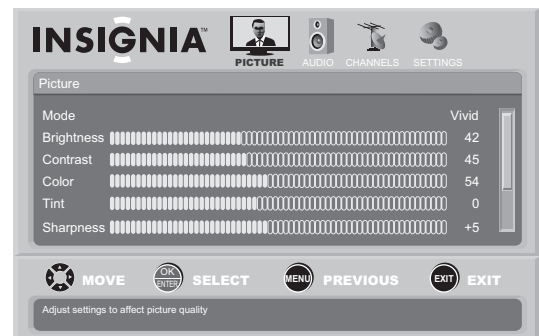

- Press ◀ or ▶ to select **SETTINGS**. The *Settings* menu opens.



- Press ▼ to highlight **Closed Caption**, then press **OK/ENTER** or ▶ to open the *Closed Caption* screen.

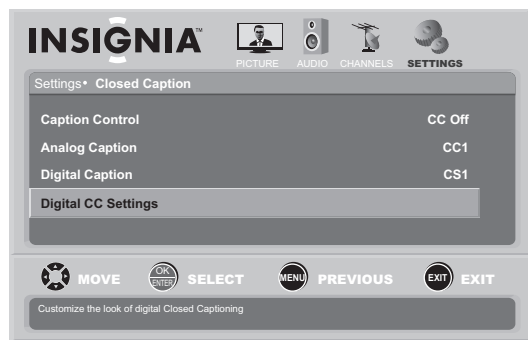

- Press ▲ or ▼ to highlight **Digital CC Settings**, then press **OK/ENTER** or ▶ to open the *Digital CC Settings* menu.

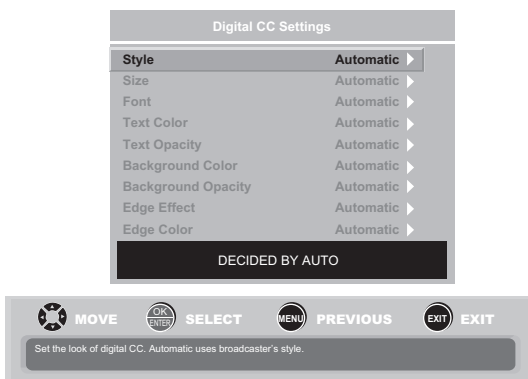

- Press ▼ to highlight an option, then press ◀ or ▶ to adjust the option. You can select:
 - **Style**—Selects the Digital Closed Caption style.
 - **Size**—Selects the font size.
 - **Font**—Selects the font type.
 - **Text Color**—Selects the text color.
 - **Text Opacity**—Selects the text opacity.
 - **Background Color**—Selects the background color.
 - **Background Opacity**—Selects the background opacity.
 - **Edge Effect**—Selects the edge style.
 - **Edge Color**—Selects the edge color.

- Press ◀ or ▶ to adjust the option.
- Press **MENU** to go to the previous menu or **EXIT** to close the menu.

Note

The default of **Digital CC Settings** is **Automatic**. All other settings will be available only when **Style** is set to **Custom**.

Adjusting time settings

Note

Unless otherwise noted, all tasks in this section are based on using the remote control.

Setting the clock

To set the clock:

- Press **MENU**. The on-screen menu opens with the *Picture* menu displayed.

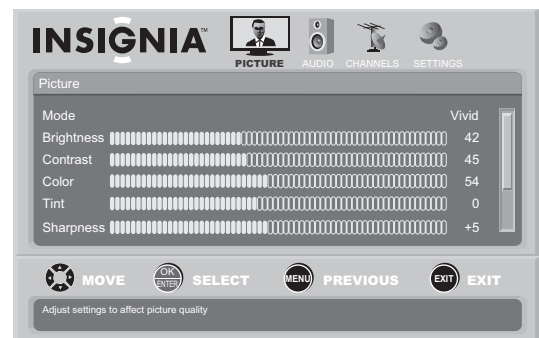

- Press ◀ or ▶ to select **SETTINGS**. The *Settings* menu opens.



- Press ▼ to highlight **Time**, then press **OK/ENTER** or ▶ to open the *Time* menu.

- Press **▲** or **▼** to highlight **Date/Time**, then press **OK/ENTER** to open the *Date/Time* screen.



- Press **▲** or **▼** to highlight the option you want to adjust, then press **OK/ENTER** or **▶** open the setting screen, or if the option has a **▶**, press **◀** or **▶** to adjust the setting.
- Press **MENU** to go to the previous menu, or press **EXIT** to close the menu.

Note

If **Mode** is set to **Auto**, the date and time are set based on a time signal received from a DTV channel, and the only options you can adjust are **Time Zone** and **Daylight Savings**.

- Press **▲** or **▼** to highlight **Sleep Timer**, then press **OK/ENTER** to open the sleep timer list.



- Press **▲** or **▼** to select the amount of time you want your TV to wait before it automatically turns off.
- Press **MENU** to go to the previous menu or **EXIT** to close the menu.

Note

You can also press **SLEEP** one or more times to set the sleep timer. You can select Off, 5, 10, 15, 30, 60, 90, 120, 180, or 240 minutes.

Adjusting menu settings

Note

Unless otherwise noted, all tasks in this section are based on using the remote control.

Setting the sleep timer

- Press **MENU**. The on-screen menu opens with the *Picture* menu displayed.

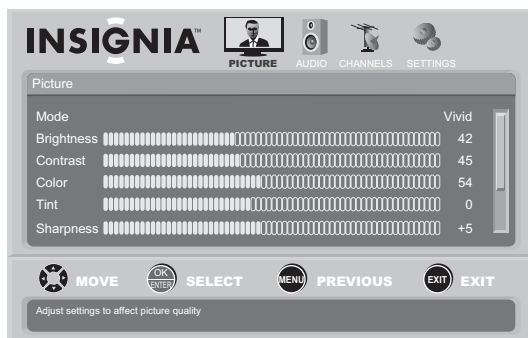

- Press **◀** or **▶** to select **SETTINGS**. The *Settings* menu opens.



- Press **▼** to highlight **Time**, then press **OK/ENTER** or **▶** to open the *Time* menu.

Selecting the menu language

To select the menu language:

- Press **MENU**. The on-screen menu opens with the *Picture* menu displayed.

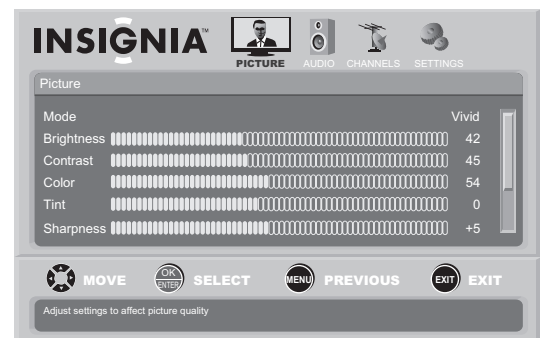

- Press **◀** or **▶** to select **SETTINGS**. The *Settings* menu opens.

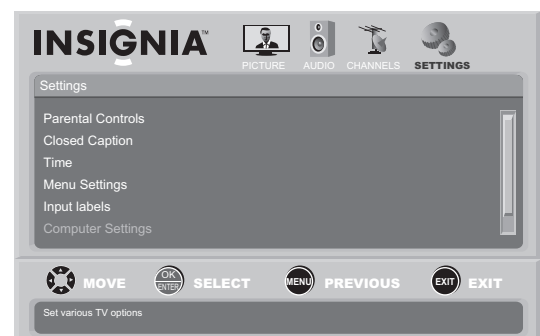

- 3 Press **▼** to highlight **Menu Settings**, then press **OK/ENTER** or **▶** to open the sub-menu.

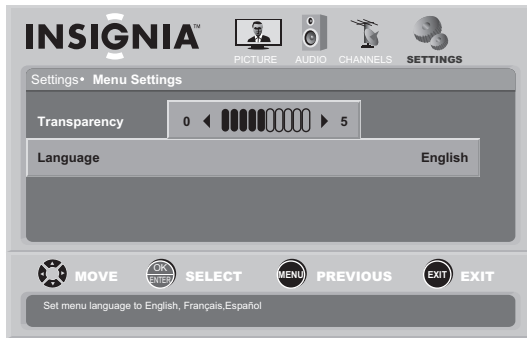

- 2 Press **◀** or **▶** to select **SETTINGS**. The *Settings* menu opens.



- 4 Press **▼** to highlight **Language**, then press **OK/ENTER** or **▶** to open the sub-menu.

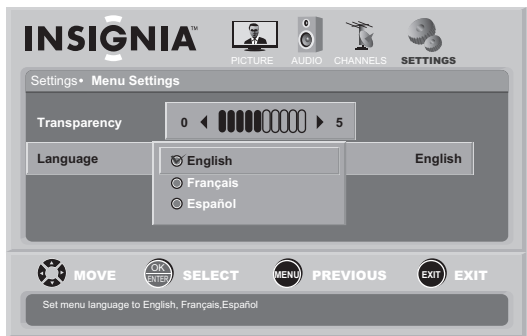

- 3 Press **▼** to highlight **Menu Settings**, then press **OK/ENTER** or **▶** to open the sub-menu.

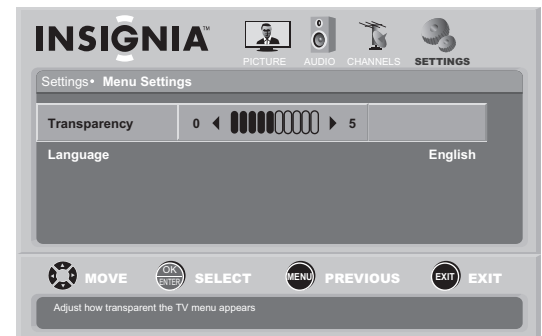

- 5 Press **▲** or **▼** to select a language.
- 6 Press **MENU** to go to the previous menu or press **EXIT** to close the menu.

- 4 Press **▼** to highlight **Transparency**, **◀** or **▶** to change the transparency.
- 5 Press **MENU** to go to the previous menu or press **EXIT** to close the menu.

Changing the menu transparency

To change the menu transparency:

- 1 Press **MENU**. The on-screen menu opens with the *Picture* menu displayed.



Labeling an input source

To change input labels:

- 1 Press **MENU**. The on-screen menu opens with the *Picture* menu displayed.

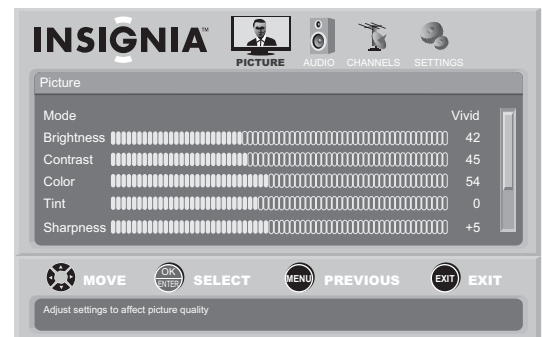

- 2 Press ◀ or ▶ to select **SETTINGS**. The *Settings* menu opens.



- 3 Press ▼ to highlight **Input labels**, then press **OK/ENTER** or ▶ to open the *Input Labels* screen.



- 4 Press ▲ or ▼ to select the input you want to change the label for (for example, **AV 1**).
- 5 Press ▶ to move the cursor to the label selection field.
- 6 Press ▲ or ▼ to select the label you want (—, **VCR, DVD, Set Top Box, Satellite, Cable Box, DVD/PVR, BD, HD, Game, Camcorder, Receiver, PC, or Other**), then press **OK/ENTER** to confirm the change.
- 7 Press ◀ or ▶ to check **Yes** or **No**, then press **OK/ENTER** to confirm.
- 8 To change another input label, press ◀ to move the cursor to the input selection field, then repeat step 4 to step 7.
- 9 Press **MENU** to go to previous menu or press **EXIT** to close the on-screen menu.

Resetting settings to the defaults

To reset settings to the defaults:

- 1 Press **MENU**. The on-screen menu opens with the *Picture* menu displayed.

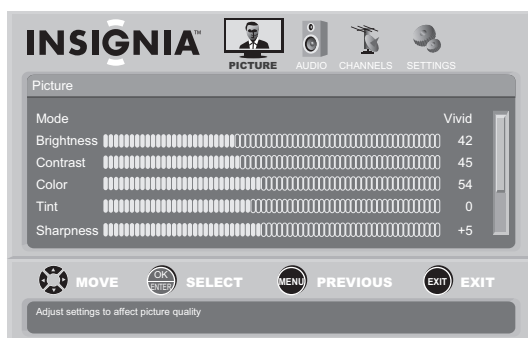

- 2 Press ◀ or ▶ to select **SETTINGS**. The *Settings* menu opens.



Note

You may need to scroll down to see the **Reset to Default** option.

- 3 Press ▼ to highlight **Reset to Default**, then press **OK/ENTER** to confirm.
- 4 Press **MENU** to go to the previous menu or press **EXIT** to close the menu.

Programming your remote control

To program your remote to control home theater devices, follow these steps.

Before proceeding, find the codes for the devices you want to program in "Manufacturers' codes" on page 35 and write them down or highlight them.

To program your remote control:

- 1 Turn on the device (for example, a DVD player) and, if needed, load media such as a DVD.
- 2 Press the device key on the remote for the device that you want to program (**TV, DVD, STB, or AUX**).
- 3 Press and hold **SET** until the red LED blinks twice, then release.
- 4 Enter the first five-digit code for the device and brand that you wish to program. The LED blinks once as each digit is entered. If the code is valid, the LED blinks twice.

Note

If the LED does not blink twice, repeat steps 2 to 4 and try entering the code again.

- 5 Aim the remote at the device and press ⏻ (power). The device should turn off. If it does not, repeat Steps 3 through 5, trying each code for your brand until you find one that works. If you cannot find a code that works, see "Searching for your code" below.
- 6 Repeat Steps 1 to 5 for the other devices you want to control. For future reference, write down each working device code.

Searching for your code

If your device does not respond to the remote control after trying all codes listed for your brand, or if your brand is not listed, try searching for your code.

To search for your code:

- 1 Turn on the device you want to control.
- 2 Press the desired device key (**TV**, **DVD**, **STB**, or **AUX**) once.
- 3 Press and hold **SET** until the red LED blinks twice, then release.
- 4 Enter **9 9 1**. The LED blinks twice.
- 5 Press the device group number for your device type (see table below).
 - **0**—Cable (cable converters, video accessories, satellite receivers)
 - **1**—TV (TVs)
 - **2**—VCR (VCRs, DVD players)
 - **3**—Audio (audio amplifiers, audio amps/tuners, CD players)
- 6 Aim the remote at the device and press **⏻** (power). The remote sends IR codes from its library to the selected device, starting with the most popular code first. If the device responds, go to Step 8.
- 7 If the device does not respond, press **CH ▲** and the remote tests the next code for that device type. Continue to press **CH ▲** until the device turns off.

Note

Press **CH ▼** to try the previous code.

- 8 Now that you have found the correct code, press **SET** to save the code that worked for your device. The LED blinks twice to indicate that the code has been saved.
- 9 To search for other device codes, repeat Steps 1 to 8.

Checking the codes

If you have set up the remote using the procedure in "Searching for your code" on page 32, you may need to find out which five-digit code is operating your equipment.

To find out which code is assigned to your TV (for example):

- 1 Press **TV** once.
- 2 Press and hold **SET** until the red LED blinks twice, then release.
- 3 Enter **9 9 0**. The LED blinks twice.
- 4 To view the code for the first digit, press **1**. Count the red LED blinks (for example, three blinks = 3), then write down the number in the appropriate code listing at the top of this column.

Note

If the LED does not blink, the code digit is 0.

- 5 Repeat Step 4 for the four remaining digits, using **2** for the second digit, **3** for the third digit, **4** for the fourth digit, and **5** for the fifth digit.
- 6 To check for other device codes, repeat Steps 1 through 5, substituting the device key for the device you would like to check.

Using learning

This universal remote control includes a learning feature (some models may not include this) so you can add functions that are unique to your home entertainment devices (such as VCR Tracking Up or Down). However, there are some considerations to keep in mind.

Precautions

- Your original remote controls must be in working order for learning to work properly.
- Learned keys are mode-specific, so each one can store a unique function for each mode.
- Do not use the following keys for learning: **Device Keys**, **SET**, or **●** (record).
- Learning capacity is approximately 42 to 75 keys, depending on the code being learned.
- Certain device functions are not learnable, including multi-frequency types, some high frequency functions, and other unusual formats.
- For optimum learning, avoid high levels of ambient light such as natural sunlight or energy-efficient fluorescent lights.

Note

Please have your original remote controls handy before programming learning.

Programming a learned key

To program a learned key:

- 1 Place your Insignia remote control head-to-head (about 2" apart) from your original remote control (the one that came with the device). Also, locate the key (on your original remote control) that you want the Insignia remote control to learn. Press the mode key you wish to learn functions on.
- 2 Press and hold **SET** until the LED blinks twice, then release.
- 3 Enter **9 7 5**. The LED blinks twice.

Note

If more than 10 seconds pass between key presses, the remote exits programming. If the LED displays one long flash instead, either your batteries are low, or the Insignia remote control has a memory fault. In either case, the remote cannot learn a new key.

- 4 Press the key on the remote you wish to program. The feedback LED stays lit for three seconds, indicating that the remote is ready to learn.

- 5 On the original remote, press and hold the key to be learned. Continue holding the key on the original remote until the Insignia's LED blinks twice.

Note

If the red LED displays one long blink, a learning error has occurred. Try repeating this step again until a successful capture occurs. If the function is still not captured, press and hold **SET** to exit programming and review the "Precautions" above. If needed, also see "Troubleshooting remote control programming" on page 35. After reviewing, start programming again at Step 1.

- 6 Repeat Steps 4 and 5 to program another key. Once you have completed programming all the keys you want, press and hold **SET** until the LED blinks twice to save all data learned.

Deleting a single learning key

This process returns the key to its original programming for the mode you select. You can also delete learned programming by teaching a different function to the key (see "Programming a Learned Key" above).

Note

If more than 10 seconds pass between key presses, the remote exits programming.
If the LED displays one long flash instead, either your batteries are low, or the Insignia remote control has a memory fault. In either case, the remote cannot learn a new key.

To delete a single learned key:

- 1 Press the mode key that you wish to remove the learned key from.
- 2 Press and hold **SET** until the LED blinks twice, then release.
- 3 Enter **9 7 6**. The LED blinks twice.
- 4 Press the key containing the learned function to be deleted, twice. The LED blinks twice and programming ends.

Deleting all learned keys in a specific mode

Note

If more than 10 seconds pass between key presses, the remote exits programming.
If the LED displays one long flash instead, either your batteries are low, or the Insignia remote control has a memory fault. In either case, the remote cannot learn a new key.

To delete all learned keys in a specific mode:

- 1 Press and hold **SET** until the LED blinks twice, then release.
- 2 Press **9 7 6**. The LED blinks twice.
- 3 Press a mode key twice (for example, **TV**, **DVD**, **STB**, or **AUX**) to clear all the learned keys for that mode. The LED blinks twice and programming ends.

Changing volume lock

The Insignia universal remote control comes preset to allow independent volume control of each selected device (global volume unlock). However, you may change the volume lock setting to global volume lock so that one device's volume controls volume in all other modes. After that, you can perform Individual volume unlock on a selected device to set its volume control for independent operation or global volume unlock to remove all volume locking.

To lock volume control to one mode (global volume lock):

- 1 Press and hold **SET** until the red LED blinks twice, then release.
- 2 Enter **9 9 3**, the LED blinks twice.
- 3 Press the mode key for the device you want to control (for example, TV).
- 4 The LED blinks twice. Now when you press **VOL+**, **VOL-**, or **Mute**, the selected device controls the volume regardless of the current mode.

To unlock all volume control (restoring global unlock):

- 1 Press and hold **SET** until the red LED blinks twice, then release.
- 2 Enter **9 9 3**, the LED blinks twice.
- 3 Press **VOL+**. The LED blinks four times. Volume is independently controlled for all programmed devices.

To unlock a single device's volume control:

- 1 Press the desired device mode key (**TV**, **DVD**, **STB**, or **AUX**).
- 2 Press and hold **SET** until the red LED blinks twice, then release.
- 3 Enter **9 9 3**. The LED blinks twice.
- 4 Press **VOL-**. The red LED blinks four times. Volume is independently controlled for the selected devices.

Programming channel lock

Channel control can be locked so that the Insignia remote controls a single device's channel-changing functions, regardless of operating mode. This is often enabled by users who watch all broadcast TV through one device (for example, a cable set-top box). The affected keys are **1** through **0**, **CH ▲**, **CH ▼**, and **RECALL**.

To lock all channel controls to one device:

- 1 Press the mode key that relates to the device that you use for channel changing control.
- 2 Press and hold **SET** until the mode LED blinks twice, then release.
- 3 Enter **9 7 3**. The mode LED blinks twice.
- 4 Press **CH ▲** once. The mode LED blinks twice.

Now, regardless of what mode you select, the channel keys will only change channels on the assigned device.

To unlock channel locks:

- 1 Press and hold **SET** until the mode LED blinks twice, then release.
- 2 Enter **9 7 3**. The mode LED blinks twice.
- 3 Press **CH ▼** once. The mode LED blinks four times.

Now the channel functions will correlate to the active mode (for example, press **CH ▲** in TV mode and the TV changes channel accordingly).

Using keymover

Your Insignia universal remote control includes a keymover feature that lets you map (or copy) keys from one mode (such as source mode) to another mode (such as destination mode) or to a different key in the same mode.

Note

Do not use any of the Device Keys, **⏻** (power), **RECORD**, or **SET** as a source or destination key.

To move keys in the same device mode:

- 1 Press the desired device key (**TV**, **DVD**, **STB**, or **AUX**).
- 2 Press and hold **SET** until the LED blinks twice, then release.
- 3 Press **9 9 4**. The LED blinks twice.
- 4 Press the key you want to move.
- 5 Press the new key that should perform the function. The LED blinks twice.
- 6 Repeat Steps 1-5 to move additional keys.

To move keys to a different device mode:

- 1 Press and hold **SET** until the LED blinks twice, then release.
- 2 Press **9 9 4**. The LED blinks twice.
- 3 Press the device key that contains the function you want to move (for example, **DVD**).
- 4 Press the key you want to move (such as **Play**).
- 5 Press the device key that you want to move the function to. (such as **TV**).
- 6 Press the key in the new mode that should perform the function (for example, **Play**). The LED blinks twice.
- 7 Repeat Steps 1-6 to move additional keys.

To restore all keymoved data in a specific mode:

- 1 Press and hold **SET** until the LED blinks twice, then release.
- 2 Press **9 9 4**. The LED blinks twice.
- 3 Press the device key you wish to remove all keymoved data from twice. The LED blinks twice.
- 4 Repeat for each device you want to restore.

To restore original key function:

- 1 Press the device key for which you wish to remove the keymoved data from a specific key.
- 2 Press and hold **SET** until the LED blinks twice, then release.
- 3 Enter **9 9 4**. The LED blinks twice.

- 4 Press the key you wish to remove the keymoved data from twice. The LED blinks twice.
- 5 Repeat Steps 1-4 for additional keys you wish to remove.

Programming macros

Your Insignia universal remote control includes the ability to program any key (other than the **SET** key) with a macro function. Each one can be set up to perform a pre-programmed set of sequential key presses with the press of a single key. A macro can be used to control a home theater operation, to set a favorite channel, or for other functions you would like to control with one key press. Each macro key can hold up to 15 key presses, total.

Note

Programming a new macro over an existing one erases the original macro.

To program a mode-independent macro:

- 1 Press and hold **SET** until the red LED blinks twice, then release.
- 2 Press **9 9 5**. The LED blinks twice.
- 3 Press the key you want to assign to a macro.
- 4 Enter the series of commands you want the macro to execute (up to 15 commands).
- 5 Press and hold **SET** until the red LED blinks twice, then release.

Now, when you press the preset macro key, the remote sends the series of commands you have entered, regardless of what mode you are in. For example, you could program a macro key to turn on both your TV and cable box and select a particular channel.

- 6 To clear the macro, repeat Steps 1-5, but do not enter a series of commands at Step 4.

To program a mode-dependent macro:

- 1 Press the device mode key (**TV**, **DVD**, **STB**, or **AUX**).
- 2 Press and hold **SET** until the LED blinks twice, then release.
- 3 Press **9 7 8**. The LED blinks twice.
- 4 Press the key you wish to assign to a macro.
- 5 Enter the series of commands you want the macro to execute (up to 15 commands).
- 6 Press and hold **SET** until the red LED blinks twice, then release.

Now, when you press the macro key, the remote sends the series of commands you have entered, but only if you are in the mode you selected in Step 1. For example, you could program the macro key to turn on both your TV and cable box and select a particular channel, but only if you are in TV mode. If you are in DVD mode, this key does not execute the macro you set up in TV mode.

- 7 To clear the macro, repeat Steps 1-6, but do not enter a series of commands at Step 5.

Troubleshooting remote control programming

Problem: The LED does not blink when you press a key.

Solution: Try pressing different keys. Replace the batteries with two new AA batteries.

Problem: The LED blinks when you press a key, but the device does not respond.

Solution: Make sure that the remote control is aimed at your device and is not more than 40 feet away.

Problem: The LED blinks one long blink while in SET mode.

Solution: An entry error has occurred (for example, wrong key). Try entering the sequence again.

Problem: The remote control does not control devices or commands are not working properly.

Solution: Try all listed codes for the device. Make sure the device operates with an infrared remote control.

Problem: No volume on a device.

Solution: See "Changing volume lock" on page 33, and make sure that the volume is not locked to a different mode already.

Problem: Channels do not change correctly when directly entering digits to change channels.

Solution: If the original remote control required you to press **Enter** to change channels, press **Enter** on this remote after entering the channel number.

Manufacturers' codes

Audio amplifiers

Audio amplifiers	
Adcom	30577, 31100
Anthem	32220
Bose	30674
Carver	30892
Durabrand	31561
Elan	30647
GE	30078
Harman/Kardon	30892
JVC	30331
Left Coast	30892
Lenox	31561
Marantz	30892
McIntosh	30251
Modulaire	30395
NEC	30264
Optimus	30395, 30823
Philips	30892
Pioneer	30823
Polk Audio	30892
RadioShack	30395
RCA	30823
Realistic	30395
Shure	30264
Sony	30689, 30815
Soundesign	30078
Victor	30331
Wards	30078
Yamaha	30354, 30133

Audio accessories

Audio accessories	
Accurian	31106
Altec Lansing	30607, 31056
Apple	31115
Creative	30872
DLO	31155
GPX	32113
Griffin	31891
iDeck	31106
iHome	32152
iLive	32113
Imerge	31491
iPort	31917
Klipsch	31339
Marantz	31491
Memorex	32119
Monitor Audio	31106
Motorola	31464
Omnifi	31605
Roku	31828
Sonance	31917
Yamaha	31809, 31810, 32021

Audio receivers

Audio receivers	
ADC	30531
Adcom	30616
Aiwa	31405, 30189, 30121, 31089, 31388, 31641
Akai	30244, 31512
Alco	31390
AMC	31077
Amphion Media Works	31563
AMW	31563
Anam	31609, 31074
Anthem	31185
Apex Digital	31257, 31430, 31774
Arcam	31189
Audiotronic	31189
Audiovox	31390
B & K	30702, 30820, 30840
BK	30702
Bose	31229, 30639, 31253, 31629, 31841, 31933
Cairn	30189
Cambridge Soundworks	31370
Capetronic	30531
Carver	31189, 30189, 30121, 31089, 31289
Coby	31389
Curtis Mathes	30014
Daewoo	31250
Denon	31360, 30121, 31104, 31142, 31306, 32857
Emerson	30531
Fisher	31801
Garrard	30463
Grundig	30189
Harman/Kardon	30110, 30189, 30891, 31289, 31304, 31306, 32241
Hitachi	31273, 31801
iLive	32013
Inkel	30491
Insignia	31030, 31077, 31893, 32169, 32175
Integra	30135, 30842, 31298, 31320, 31805
iSymphony	32258
JBL	30110, 31306
JVC	31058, 30074, 31374, 31495, 31871, 32239
Kawasaki	31390
Kenwood	31313, 31570, 30077, 30186, 31027
KLH	31390, 31412, 31428
Koss	31366, 31497
Lexicon	31076
LG	31293, 32197
Linn	30189
Liquid Video	31497
Magnavox	31189, 31269, 30189, 30391, 30531, 31089, 31266, 31514
Marantz	31189, 31269, 30189, 30891, 31089, 31289
McIntosh	31289
Micromega	31189, 30189
Mitsubishi	31393
Musicmagic	31089
Myryad	31189
Nakamichi	31313, 30097, 31555
Norcent	31389

Audio receivers	
Nova	31389
Onkyo	30135, 30842, 31298, 31320, 31531, 31805, 31905
Optimus	31023, 30074, 30014, 30121, 30186, 30531, 31074
Oritron	31366, 31497
Outlaw	30391
Panasonic	31308, 31518, 30367, 31275, 31288, 31316, 31548, 31633, 31763, 31764
Philips	31189, 31269, 30189, 30391, 30891, 31089, 31266
Pioneer	31023, 30014, 30150, 30244, 30531, 30630, 31123, 31384, 31935
Polaroid	31508
Polk Audio	30189, 31289
Proscan	31254
RadioShack	31609
RCA	31023, 31609, 31254, 30531, 31074, 31123, 31390, 31511
Realistic	31609, 30121, 30186
Revox	30189
Rio	31869
Samsung	31295, 31304, 31500
Sangean	32165
Sansui	31189, 30189, 31089
Sanyo	31251, 31469, 31801
Sharp	30186, 31286
Sharper Image	31556
Sherwood	30491, 31077, 31653, 31905, 32169
Sherwood	Newcastle 32169
Sonic Blue	31869
Sonic Frontiers	31185
Sony	31058, 31441, 31258, 31759, 31622, 30474, 31158, 31406, 31558, 31658, 31758, 31822, 31858
Stereophonics	31023
Sunfire	31313
Teac	30463, 31074, 31390, 31528
Technics	31308, 31518, 31633
Thorens	31189
Toshiba	30135, 30842, 31123, 31788
Venturer	31390
Victor	30074
Wards	30189, 30014
XM	31406
Yamaha	31023, 30176, 30186, 30376, 31176, 31276, 31331, 31375, 31376, 31476, 31815, 32061
Zenith	30857, 31293

Cable converters

Cable converters	
A-Mark	00008,00144
ABC	00237,00003,00008
Accuphase	00003
Acorn	00237
Action	00237
Active	00237
ADB	02586
Americast	00899
Amino	01602,01822

Cable converters	
Archer	00237
BCC	00276
Bell South	00899
British Telecom	00003
Century	00008
Cisco	01877,00877,01982
Clearmaster	00883
ClearMax	00883
Cool Box	00883
Coolmax	00883
Digeo	01187, 02187
Director	00476
Fosgate	00276
GE	00144
General Instrument	00476,00810,00276,00003
Gibraltar	00003
GMI	00883
GoldStar	00144
Hamlin	00009,00273
Hitachi	00003,00008, 00009
i3 Micro	01602
Insight	00476,00810
Jerrold	00476,00810, 00276, 00003
Memorex	00000
Mitsubishi	00003
Motorola	01376,00476, 00810, 00276, 01187, 01106, 01982
Multitech	00883
Myrio	01602,01822
Nova Vision	00008
Novaplex	00008
Pace	01877,00877,00237,00008,01982
Panasonic	00000,00008,00144,00107,01982
Paragon	00000,00008, 00525
Penney	00000
Philips	01305,00317
Pioneer	01877,00877, 00144, 00533
Pulsar	00000
Quasar	00000
RadioShack	00883
RCA	01256
Regal	00276,00279,00273
Runco	00000
Samsung	00003,00144,01982
Scientific Atlanta	01877,00877,00477,00237,00003,00000,00008,01982
Sejin	01602
Sony	01006
Sprucer	00144
Starcom	00003
Supercable	00276
Supermax	00883
Thomson	01256

Cable/PVR combos

Cable/PVR combos	
Americast	00899
Amino	01822
Cisco	01877, 01982
Digeo	01187, 02187
General Instrument	00810
Jerrold	00810
Motorola	01376, 00810, 01187, 01106, 01982
Myrio	01822
Pace	01877, 00237, 01982
Pioneer	01877
RCA	01256
Scientific Atlanta	01877, 01982
Sony	01006
Supercable	00276
Thomson	01256
Zenith	00899

CD players

CD players	
Acoustic Research	30420
Aiwa	30157
Arcam	30157
Audio Research	30157
Burmester	30420
Cairn	30157
California Audio Labs	30029
Cambridge Soundworks	30157
Carver	30157
Curtis Mathes	30032
Denon	30034
DKK	30000
DMX Electronics	30157
Fisher	30000
Garrard	30393,30420
Genexxa	30032
Grundig	30157
Hafler	30173
Harman/Kardon	30100,30157,30173
Hitachi	30032
Inkel	30157,30180
Integra	30101
JVC	30032,30072
Kenwood	30626,30000,30029,30028,30190
KLH	31318,31711
Krell	30157
Linn	30157
Magnavox	30157,30038,30274
Marantz	30626,30029,30157,30038,30180,30435
Matsui	30157
McIntosh	30256,30290,30660
MCS	30029
Memorex	30000, 30032,30420
Micromega	30157
Miro	30000
Mission	30157
Modulaire	30000,30032,30087,30180,30420
MTC	30420

CD players	
Myryad	30157
NSM	30157
Onkyo	31327,30101
Optimus	30000,30032,30087,30393,30420
Panasonic	30029,30388,30752
Parasound	30420
Penney	30029
Philips	30626,30157,30274
Pioneer	31062,30032,31087
Polk Audio	30157
Proceed	30420
Proton	30157
QED	30157
Quad	30157
Quasar	30029
RadioShack	30000,30032,30180,30420
RCA	31062, 30032,30053,30420
Realistic	30000,30032,30087,30180,30420
Revox	30157
Roksan	30435
Rotel	30157,30420
SAE	30157
Sansui	30000,30157
Sanyo	30000,30087
Sharp	30180
Sherwood	30180
Sonic Frontiers	30157
Sony	30490,30000,30100,31364,30185
Sugden	30157
Sylvania	30157
Symphonic	30180
TAG McLaren	30157
Tandy	30032
Tascam	30393,30420
Teac	30490,30180,30393,30420
Technics	30029
Thule Audio	30157
Victor	30072
Wards	30032,30157,30053,30087
Yamaha	30490,30036,31292
Yorx	30000

DVD players	
Arrgo	21023
Aspire Digital	21168, 21407
Astar	21489
Audiovox	20717, 20790, 21041, 21071, 21072, 21121, 21122
Axion	21071, 21072
B & K	20655, 20662
BBK	21224
Bel Canto Design	21571
Blaupunkt	20717
Blue Parade	20571
Blue Sky	20695
Bose	21895, 22023
Brandt	20651
Broksonic	20695, 20868
California Audio Labs	20490
Celestial	21020
Centrex	20672, 21004
Cinea	20831
CineVision	20876, 20833, 20869
Citizen	21003, 20695, 21277
Clairtone	20571
Coby	20778, 21077, 21086, 21107, 21177
Craig	20831
Creative	20503, 20539
Curtis Mathes	21087
CyberHome	20816, 20874, 21023, 21024, 21117, 21129, 21502, 21537
Cytron	20705
Daewoo	20784, 20705, 20770, 20833, 20869, 21169, 21172, 21234, 21242
Dansai	20770
Daytek	20872
Decca	20770
Denon	20490, 20634, 22258
Denver	20778
Desay	21407
DigitalMax	21738
Digitrex	20672
Disney	20675, 21270
DiViDo	20705
Dual	20675, 21068, 21085
Durabrand	21127
DVD2000	20521
Electrohome	21003
Emerson	20591, 20675, 20821, 21268
Enterprise	20591
Entivo	20503, 20539
Enzer	20770
ESA	20821, 21268
Firstline	20651
Fisher	20670
Funai	20675, 21268, 21334
Gateway	21073, 21077, 21158
GE	20522, 20815, 20717
Go Video	20573, 20744, 20717, 20715, 20741, 20783, 20833, 20869, 21044, 21075, 21099, 21158, 21304, 21730
Go Vision	21071, 21072

DVD players

DVD players	
3D LAB	20503, 20539
Accurian	20675, 21072, 21416
Advent	21016
Afreey	20698
Aiwa	20641
Akai	20695, 20705, 20770, 20899, 21089
Alba	20672, 20717
Alco	20790
Allegro	20869
Amphion Media Works	20872
AMW	20872
Apex Digital	20533, 20672, 20717, 20755, 20794, 20796, 20797, 20830, 21004, 21020, 21056, 21061, 21100

DVD players	
GoldStar	20741, 20869
Goodmans	20790
Gradiente	20490, 20651
Greenhill	20717
Grundig	20539, 20705
Harman/Kardon	20582, 20702
Hello Kitty	20831
Hitachi	20573, 20664, 21247
Hiteker	20672
Humax	21500, 21588
iLo	21348
Initial	20717
Insignia	21268
Integra	20571, 20627, 21769
IRT	20783
JBL	20702
Jensen	21016
JMB	20695
JVC	20558, 20623, 20867, 21164, 21275, 21550
Kawasaki	20790
Kenwood	20490, 20534
KLH	20717, 20790, 21020, 21149
Kloss	20533
Koss	20651, 21061
Lasonic	20627, 20798
Lecson	21533
Lennox 21127	
LG	20591, 20741, 20869
LiteOn	21058, 21158, 21416, 21440, 21656, 21738
Loewe	20511, 20741
Logix	20783
Magnasonic	20651, 20675
Magnavox	20503, 20539, 20646, 20675, 20821, 21268, 21354, 21506
Marantz	20503, 20539, 20675
McIntosh	21533, 21273
Medion	20651
Memorex	20695, 20831, 21270
Microsoft	20522, 22083
Minato	20752
Mintek	20839, 20717
Mitsubishi	21521, 20521
NAD	20741
Naiko	20770
NEC	20785, 20869
Nesa	20717
NexxTech	21402
Norcent	21003, 20872, 21107, 21265
Onkyo	20503, 20627, 21769
Oppo	20575, 21224
Optimus	20571
Oritron	20651
Palsonic	20672
Panasonic	20503, 20490, 20571, 20632, 20703, 21362, 21462, 21490, 21641, 21762
Philco	20675
Philips	20503, 20539, 20646, 20675, 20854, 21260, 21267, 21340, 21354, 22056, 22084
PianoDisc	21024

DVD players	
Pioneer	20525, 20571, 20142, 20631, 20632, 21460, 21512, 21571
Polaroid	21020, 21061, 21086
Polk Audio	20539
Portland	20770
Presidian	20675, 21072, 21738
Prima	21016
Proceed	20672
Proscan	20522
ProVision	20778
Qwestar	20651
Radionette	20741
RadioShack	20571
RCA	20522, 20571, 20717, 20790, 20822, 21022, 21132, 21769
Realistic	20571
Reoc	20752
Rio	20869
Rotel	20623, 21178
Rowa	20823, 21004
Saba	20651
Sampo	20698, 20752
Samsung	20490, 20573, 20744, 20199, 20820, 20899, 21044, 21075
Sansui	20695
Sanyo	20670, 20675, 20695, 20873, 21334
Schneider	20783
Schwaiger	20752
Sensory Science	21158
Sharp	20630, 20675, 20752, 21256, 22250
Sharper Image	21117
Sherwood	20770, 21043, 21077
Sherwood Newcastle	21077
Shinsonic	20533, 20839
Slim Art	20784
Sonic Blue	20573, 20715, 20783, 20869, 21099
Sony	20533, 21533, 20864, 21033, 21070, 21431, 21516
Sova	21122
Superscan	20821
SVA	20717
Sylvania	20675, 20821, 21268
Symphonic	20675, 20821, 21268, 21334
Tatung	20770
Teac	20571, 20717, 20790
Technics	20490, 20703
Technika	20770
Terapin	21031
Tevion	20651
Theta Digital	20571
Thomson	20522, 20511
Tivo	21503, 21512, 21588
Toshiba	20503, 20573, 20539, 20695, 21045, 21154, 21503, 21510, 21588, 21769
Unimax	20770
Universum	20591
Urban Concepts	20503, 20539
US Logic	20839
V	21064, 21226

DVD players	
Venturer	20790
Vizio	21064, 21226
Xbox	20522, 22083
Yamaha	20490, 20539, 20545
Yamakawa	20872
Zenith	20503, 20591, 20741, 20869
Zeus	20784
Zoece	21265

DVD players (Blu Ray and HD-DVD)

DVD players (Blu Ray and HD-DVD)	
Denon	22258
Integra	21769
LG	20741
Microsoft	22083
Onkyo	21769
Panasonic	21641
Philips	22084
Pioneer	20142
RCA	21769
Samsung	20199
Sharp	22250
Sony	21516
Toshiba	21769
Xbox	22083

DVD/PVR combos controlled by the DVD

DVD/PVR combos controlled by the DVD	
Go Video	21730
Humax	21500, 21588
LG	20741
Panasonic	20490
Philips	21340
Pioneer	20631, 21512
RCA	20522
Sharp	21256
Sony	21033, 21070
Sylvania	20675
Tivo	21512
Toshiba	21503, 21510, 21588

Home automation

Home automation	
Accutek	31215
Amana	31716
Bonaire	30846, 31215, 31861
Da-Lite	31794
Draper	32190
Frigidaire	31333
GE	30240
GoldStar	31537
Holmes	31215
Kenmore	31537
Lasko	30846, 31890
LG	31537
Lightolier	30184
Lutron	30597, 30318, 31239, 31597
Marmitek	30167

Home automation	
One For All	30167
PCS	30184
RadioShack	30240
Screen Research	32097
Security System	30167
Sharper Image	30846
SmartLinc	30184
Universal	30167
Universal X10	30167
Whirlpool	31332
Windmere	31215
X10	30167

DVR/PVR Systems for satellite receivers

DVR/PVR systems for satellite receivers	
AlphaStar	00772
Bell ExpressVu	00775, 01170
Chaparral	00216
Coolsat	01806
Crossdigital	01109
DireTV	01377, 00392, 00566, 00639, 01639, 01142, 00247, 00749, 01749, 00819, 01856, 01076, 01108, 00099, 01109, 01392, 01414, 01442, 01443, 01444, 01609, 01640
Dish Network System	01505, 00775, 01170, 01775
Dishpro	01505, 00775, 01775
Echostar	01505, 00775, 01170, 01775
Expressvu	00775, 01775
Fortec Star	01821
Funai	01377
GE	00392, 00566
General Instrument	00869
GOI	00775, 01775
Hitachi	00749, 00819
Houston	00775
HTS	00775, 01775
Hughes Network Systems	01142, 00749, 01749, 01442, 01443, 01444
Humax	01790
Innova	00099
Jerrold	00869
JVC	00775, 01170, 01775
LG	01226, 01414
Magnavox	00722
McIntosh	00869
Mitsubishi	00749
Motorola	00869
Netsat	00099
Next Level	00869
Panasonic	00247, 00701
Pansat	01807
Philips	01142, 00749, 01749, 00775, 00819, 01076, 00722, 00099, 01442
Primestar	00869
Proscan	00392, 00566
RadioShack	00566, 00775, 00869
RCA	00392, 00566, 01142, 00775, 00855, 00143, 01392, 01442
Samsung	01377, 01142, 01276, 01108, 01109, 01442, 01609

DVR/PVR systems for satellite receivers	
SKY	00099
Sony	00639, 01639, 01640
Star Choice	00869
Star Trak	00772, 00869
Thomson	00392, 00566
Tivo	01142, 01442, 01443, 01444
Toshiba	00749, 01749, 00790, 01285
UltimateTV	01392, 01640
Ultrasat	01806
Uniden	00722
Voom	00869
Zenith	01856

TVs

TVs	
A-Mark	10047, 10054
Accurian	11803
Accuscan	10047
Action	10030, 10873
Admiral	10047, 10054, 10017, 10051, 10093, 10463, 10180
Advent	10761, 10783, 10815, 10817, 10842
Adventuri	10000
Agna	10150
Aiko	10092
Akai	10060, 10812, 10702, 10030, 10145, 10056, 10672, 11675, 11676, 11935
Albatron	10700, 10843
Alfide	10672
Alleron	10030
Ambassador	10150, 10177
America Action	10180
American High	10000, 10060
Ampro	10751
Amstrad	10171, 10177
Amtron	10000, 10180
Anam	10180
AOC	10180, 10030, 11365
Aomni	11623
Apex Digital	10156, 10748, 10879, 10765, 10767, 10890, 11217
Astar	11531, 11738
Audinac	10180
Audiovox	10451, 10180, 10092, 10623, 10802, 10846, 10875, 11937, 11951, 11952
Aventura	10171
Axion	11937
Baysonic	10180
Beaumarck	10017, 10178, 10030
Belcor	10030
Bell & Howell	10054, 10154, 10093
BenQ	11032, 11212, 11315
Boxlight	10893
Bradford	10180
Brockwood	10178, 10030, 10056
Broksonic	10236, 10463, 10180, 10177, 11935
Byd:sign	11309
Candle	10030, 10056
Capehart	10017, 10178, 10030, 10092

TVs	
Carnivale	10030
Carver	10054
Celebrity	10000
Celera	10765
Changhong	10156, 10765, 10767, 10783
Cineral	10451, 10092
Citek	10047
Citizen	10054, 10000, 10451, 10463, 10180, 10060, 10030, 10171, 10092, 10056, 11935
Clarion	10180
Classic	10030, 10092, 10056
Colortyme	10047, 10054, 10017, 10060, 10178, 10030
Commercial Solutions	11447, 10047
Concerto	10056
Conic	10178
Contec	10180
Craig	10180, 10171
Crosley	10054, 10000, 10180, 10030, 10171
Crown	10093, 10180, 10056, 10672
Crown Mustang	10672
Curtis Mathes	10047, 10054, 10154, 10000, 10051, 10451, 10093, 10180, 10060, 10702, 10178, 10030, 10145, 10166, 10056, 10466, 11147, 11347
CXC	10180
Cytron	11326
Daewoo	10451, 10178, 10092, 11661, 11756, 10623, 10661, 10672, 11755
Dayton	10092
Daytron	10178, 10030, 10092, 10056
Dell	11080, 11178, 11264, 11403, 11863
Denon	10145
Digital Life	10872
Dream Vision	11164
Dumont	10017, 10180, 10178
Durabrand	10463, 10180, 10178, 10171, 11034
Dwin	10093, 10720, 10774
Dynex	11463, 11780, 11785, 11810
Eaton	10060
Electroband	10000
Electrograph	11623, 11755
Electrohome	10154, 10000, 10463, 10150, 10178, 10030, 10056
Emerald	10178, 10177
Emerson	10047, 10154, 10451, 10236, 10463, 10180, 10150, 10178, 10171, 10177, 10623, 11394, 11963
Emprex	11422
Envision	10030, 10813, 11365
Epson	10833, 10840
ESA	10812, 10171, 11963
Fisher	10054, 10154, 10000
Fortress	10093
Fujitsu	10683, 10809, 10853
Funai	10000, 10180, 10171, 11271, 11963
Futuretech	10180
Gateway	11756, 11755
GE	11447, 10047, 10000, 10051, 10451, 10060, 10178, 10030, 11147, 11347
Gemini	10047
Gibraltar	10017, 10000, 10030

TVs	
Go Video	10886
Go Vision	11937
GoldStar	10047, 10054, 10178, 10030, 10056, 11154
Gradiente	10053, 10056
Grundig	10706, 10672, 10683
Grundy	10180
Grunpy	10180
Haier	11034
Hallmark	10236, 10180, 10178
Hannspre	11348, 11351, 11745
Harley Davidson	10000, 10180, 10060, 10178, 10030
Harman/Kardon	10054
Harvard	10180
Havermy	10093
Heathkit	10017
Helios	10865
Hello Kitty	10451
Hewlett Packard	11494, 11502, 11642
Hisense	10748
Hitachi	10047, 10054, 10017, 10000, 10051, 11145, 10145, 10056, 11445, 11643
HP	11494, 11502, 11642
Hyundai	10849, 10865, 11219, 11294
iLo	11286, 11603, 11684, 11990
Ima	10236, 10180, 10178
Infinity	10054
InFocus	11164
Initial	11603, 11990
Insignia	10171, 11204, 11326, 11517, 11564, 11641, 11710, 11780, 11963, 12002
Inteq	10017, 10145
JBL	10054
JCB	10000
Jensen	10761, 10815, 10817
JIL	10030
Jutan	10030
JVC	10054, 10053, 10030, 10650, 10731, 11253, 11774
Kamp	10017, 10180
Kawasho	10030
KEC	10180, 10060
Kenwood	10180, 10030
KLH	10156, 10180, 10765, 10767
Kloss	10030
Konka	10180, 10720
KTV	10463, 10180, 10030
Lark	10154
LG	10054, 11265, 10060, 10178, 10030, 10056, 10700, 10856, 11154, 11178, 11423, 11993
Lloyd's	10236, 10180, 10030, 10056
Logik	10236, 10180, 10056
Luxman	10056
LXI	10047, 10054, 10017, 10154, 10000, 10156, 10051, 10093, 10060, 10053, 10178, 10030, 10171, 10166, 10056
Magnasonic	10054, 10000, 10156, 10093, 10030, 10092, 10056
Magnavox	10047, 11454, 10054, 10154, 10000, 10250, 10051, 10180, 10060, 10030, 10171, 10092, 10706, 10802, 11198, 11254, 11365, 11755, 11866, 11963, 11990

TVs	
Majestic	10017
Marantz	11454, 10054, 10030, 10704, 10855, 11154, 11398
Matsui	10056, 10177
Matsushita	10250, 10051, 10650
Maxent	11756, 10762, 11211, 11714, 11755, 11757
Megapower	10700
Megatron	10047, 10178, 10145, 10056
Memorex	10154, 10463, 10180, 10150, 10178, 10030, 10056
MGA	10150, 10178, 10030
MGN Technology	10178
Micro Genius	10150
Midland	10047, 10017, 10051, 10056
Mintek	11603, 11990
Mitsubishi	10154, 10093, 11250, 10150, 10178, 10030, 10836, 10868, 11392
Monivision	10700, 10843
Motorola	10054, 10051, 10093, 10150
MTC	10180, 10060, 10030, 10092, 10056
Multitech	10180
NAD	10156, 10178, 10166, 10056, 10866, 11156
NEC	10047, 10178, 10030, 10056, 10497, 10704, 10882, 11398, 11704
NetTV	10762, 11755
New Tech	10056
Nikko	10178, 10030, 10092
Nikkodo	10178, 10030, 10092
Nishi	10030
Norcent	10748, 10824, 11365
Norwood Micro	11286
NTC	10092
Nyon	10000
Olevia	11144, 11240, 11331, 11610
Onwa	10180
Optimus	10154, 10250, 10093, 10180, 10150, 10178, 10030, 10166, 10056, 10650
Optoma	11348
Optonica	10093
Orion	10017, 10236, 10463, 10180, 10178, 11463, 10177
Pace	10092
Panasonic	10054, 10000, 10156, 10250, 10051, 10236, 10030, 10650, 11291, 11310, 11410, 11480, 11941
Panda	10706
Paxonic	10060, 10030
PCE	10156, 10060
Penney	10047, 10000, 10156, 10250, 10051, 10060, 10178, 10030, 10056, 11347
Petters	11523
Philco	10054, 10463, 10030, 10145
Philips	11454, 10054, 10030, 10171, 10056, 10690, 11154, 11254, 11744, 11867
Pilot	10051, 10060, 10178, 10030, 10056
Pioneer	10166, 10679, 10866, 11260, 11398, 11457
Planar	11496
Polaroid	10765, 10865, 11276, 11314, 11326, 11328, 11341, 11523, 11766, 12002
Portland	10451, 10092
Precision	10236, 10180, 10177

TVs	
Prima	10761, 10783, 10815, 10817, 11785
Princeton	10700, 10717
Prism	10250, 10051
Proscan	11447, 10047, 10466, 11347
Proton	10178, 10466
Pulsar	10017, 10092
Pulser	10178, 10092
Quartz	10150, 10178
Quasar	10250, 10051, 10650
Rabbit	10047
RadioShack	10047, 10154, 10180, 10150, 10178, 10030, 10056
RCA	11447, 10047, 10054, 10000, 10051, 10093, 10178, 12002, 11958, 11781, 11547, 11347, 11247, 11147, 11047, 10774, 10679, 10090
Realistic	10047, 10154, 10180, 10150, 10178, 10030, 10056
RevolutionHD	11623
Runco	10017, 10060, 10030, 10497, 10603, 11292, 11398, 11629
Sampo	10047, 10030, 11756, 10762, 11755
Samsung	10047, 10054, 10017, 10154, 10060, 10812, 10702, 10178, 10030, 10056, 10587, 10766, 10814, 11060, 11575
Sanky	10060, 10030
Sansui	10463, 10060, 10030, 11409, 11935
Sanyo	10047, 10054, 10154, 10000, 10463, 10171, 10088, 10799, 10893, 11142, 11755
Saville	10060
Sceptre	10878, 11217, 11360, 11599
Scotch	10178
Scott	10236, 10180, 10178, 10030, 10177, 11711
Sears	10047, 10054, 10017, 10154, 10000, 10156, 10051, 10093, 10060, 10053, 10178, 10030, 10171, 10166, 10056
Seleco	11351
Sharp	10054, 10093, 10180, 10491, 10688, 10689, 10818, 10851, 11602
Sheng Chia	10093
Shivaki	10178
Siemens	10145
Signature	10047, 10093, 10030
Simpson	10178, 10030
Singer	10060, 10092
Solar Drape	10000
Sole	10813, 11623
Sony	10017, 10154, 11100, 10000, 10150, 10053, 10834, 11685
Soundesign	10180, 10178, 10056
Sova	11952
Soyo	11520, 11826
Spectravision	10156, 10178
Squareview	10171
SR2000	10154, 10171
SSS	10180
Starlite	10236, 10180
Studio Experience	10843
Superscan	10093, 10864
Supreme	10000
SV2000	10054
SVA	10748, 10587, 10865, 10870, 10871, 10872

TVs	
Sylvania	10047, 10054, 10154, 10000, 10051, 10178, 10030, 10171, 10092, 10056, 11271, 11314, 11394, 11864, 11963
Symphonic	10000, 10180, 10178, 10171
Syntax	11144, 11240, 11331, 11610
Tandy	10093
Tatung	10000, 10051, 11756, 11286
Teac	10154, 10706, 10689
Technics	10054, 10250, 10051
Technovox	10030
Techview	10847, 12004
Techwood	10250, 10051, 10060, 10056
Teco	11040
Teknika	10054, 10463, 10180, 10150, 10060, 10178, 10092, 10056
Telecolor	10017
Telefunken	10702, 10056
Thomas	10047, 10178, 10056
Thomson	11447, 10047
TMK	10236, 10180, 10178, 10056, 10177
TNCi	10017
Tocom	10156
Toshiba	10154, 11256, 10156, 10150, 11265, 10060, 11145, 10145, 10166, 12006, 11935, 11704, 11656, 11635, 11524, 11356, 11164, 11156, 10845, 10832, 10822, 10650
Totevision	10051
Toyomenka	10178
Truetone	10250, 10051
TruTech	11723
TVS	10463
Ultra	10092
Universal	10047
Universum	10177
US Logic	11286
V	11756, 10864, 10885, 11755
Vector Research	10030
Victor	10053
Vidikron	10054, 11292, 11398, 11629
Vidtech	10178
Viewsonic	10857, 10864, 10885, 11330, 11578, 11627, 11640, 11755, 12014
Viking	10060
Viore	11684
Vizio	11756, 11758, 10864, 10885, 11755
Wards	10047, 10054, 10017, 10154, 10000, 10051, 10093, 10236, 10178, 10030, 10166, 10056, 10866, 11156
Waycon	10156
Welton	10178
Westinghouse	10000, 10451, 10885, 10889, 10890, 11282, 11577, 11712
White Westinghouse	10451, 10236, 10463, 10623, 10889
World	10451, 10236, 10463, 10180
Wyse	11365
XR-1000	10154, 10180, 10171
Yamaha	10030, 10769, 10833, 10839, 11526
Yorx	10030
Zenith	10047, 10017, 10000, 10093, 10463, 11265, 10812, 10178, 10030, 11145, 10145, 10171, 10092

TV/DVD combination controlled by the DVD

TV/DVD combination controlled by the DVD	
Advent	21016
Akai	20695
Apex Digital	20830
Audiovox	21071, 21121, 21122
Axion	21071
Broksonic	20695
Citizen	20695
Emerson	20675, 21268
ESA	21268
Funai	21268
Go Vision	21071
Hitachi	21247
Insignia	21268
Jensen	21016
Magnavox	21268
Panasonic	21490
Philips	20854, 21260
Prima	21016
RCA	21022
Samsung	20899
Sansui	20695
Sova	21122
Sylvania	20675, 21268
Toshiba	20695

TV/DVD combination controlled by the TV

TV/DVD combination controlled by the TV	
Accurian	11803
Akai	11675, 11935
Audiovox	11937, 11951, 11952
Axion	11937
Broksonic	11935
Citizen	11935
Dynex	11810
Emerson	11394, 11963
ESA	11963
Funai	11963
iLo	11990
Initial	11990
Insignia	11963, 12002
LG	11993
Magnavox	11866, 11963, 11990
Maxent	11714
Mintek	11990
Panasonic	11941
Polaroid	11523, 11766, 12002
RCA	11958, 12002
Sansui	11935
Sova	11952
Sylvania	11394, 11864, 11963
Techview	12004
Toshiba	11524, 11635, 11935, 12006

TV/VCR combination controlled by the TV

TV/VCR combination controlled by the TV	
America Action	10180
Audiovox	10180
Emerson	10236

TV/VCR combination controlled by the VCR

TV/VCR combination controlled by the VCR	
Broksonic	20479, 21479
Citizen	21278
Curtis Mathes	21035
Daewoo	21278
Emerson	20479, 20593, 21278, 21479
Funai	20000
GE	20807, 21035, 21060
GoldStar	21237
Harley Davidson	20000
Hitachi	20000
LG	21037
Lloyd's	20000
Magnasonic	20593, 21278
Magnavox	20000, 20593, 21781
Memorex	20162, 21037, 21162, 21237, 21262
Mitsubishi	20807
Optimus	20162, 20593, 21162, 21262
Orion	20479, 21479
Panasonic	20162, 21035, 21162, 21262
Penney	21035, 21237
Quasar	20162, 21035, 21162
RadioShack	20000, 21037
RCA	20807, 21035, 21060
Samsung	21014
Sansui	20000, 20479, 21479
Sears	20000, 21237
Sony	20000, 21232
Sylvania	21781
Symphonic	20000, 20593
Thomas	20000
Toshiba	20845, 21145
Zenith	20000, 20479, 21479

TV/VCR/DVD combination controlled by the DVD

TV/VCR/DVD combination controlled by the DVD	
Akai	20899
Broksonic	20868
Emerson	20821
ESA	20821
Funai	21334
Magnavox	20821
Panasonic	21362, 21462
RCA	21132
Sharp	20630
Superscan	20821
Sylvania	20821
Symphonic	20821
Toshiba	21045

TV/VCR/DVD combination controlled by the VCR

TV/VCR/DVD combination controlled by the VCR	
Sharp	20807

VCRs

VCRs	
A-Mark	20037, 20000, 20046
ABS	21972
Accurian	20000
Admiral	20060, 20048, 20039, 20209, 20479
Adventura	20037, 20000
Aiwa	20037, 20000
Alba	20209
Alienware	21972
Allegro	20039
American High	20035, 20081
Amstrad	20000
Astra	20035
Audiovox	20037, 20038
Avis	20000
Bell & Howell	20035, 20048, 20039, 20000, 20046, 20479
Broksonic	20184, 20121, 20209, 20479, 21479
Calix	20037
Candle	20037, 20038
Canon	20035
Carver	20035, 20081
Citizen	20035, 20037, 20000, 20209, 20479, 21278
Classic	20037
Colortyme	20060, 20035, 20045
Colt	20000
Craig	20037
Criterion	20000
Crosley	20035, 20081, 20000, 20149
Curtis Mathes	20060, 20035, 20162, 20000, 21035
CyberPower	21972
Daewoo	20037, 20045, 20046, 21278
Daytron	20037
Dell	21972
Denon	20081, 20042
DirecTV	20739
Dual	20000
Durabrand	20039, 20038
Dynatech	20000
Electrohome	20060, 20037, 20000, 20043, 20209
Electroponic	20037
Emerald	20184, 20121
Emerex	20032
Emerson	20037, 20184, 20000, 20121, 20043, 20209, 20479, 20593, 21278, 21479, 21593
Fisher	20039, 20000, 20046
Fuji	20035, 20033
Fujitsu	20000
Funai	20037, 20000, 20593, 21593
Garrard	20000
Gateway	21972
GE	20060, 20035, 20048, 20000, 20149, 20807, 21035, 21060
Gemini	20060
Genexxa	20037, 20000

VCRs	
Go Video	20614
GoldStar	20035, 20037, 20039, 20000, 20038, 21237
Goodmans	20037, 20081, 20000
Gradiente	20000
Granada	20081, 20042
Grundig	20081
Harley Davidson	20000
Harman/Kardon	20081, 20038
Headquarter	20046
Hewlett Packard	21972
HI-Q 20035,	20000
Hitachi	20035, 20037, 20045, 20000, 20042, 20089
Howard Computers	21972
HP	21972
Hughes Network Systems	20042, 20739
Humax	20739
Hush	21972
Hytek	20000
iBUYPOWER	21972
Instant Replay	20035
Jensen	20067
JVC	20067, 21162
KEC	20037
Kenwood	20067, 20038, 20046
Kodak	20035, 20037
KTV	20000
LG	20037, 20038, 21037
Linksys	21972
Lloyd's	20000, 20038
Loewe	20081
Logik	20000
Luxor	20046
LXI	20037, 20000, 20042, 20067
Magnasonic	20037, 20000, 20593, 21278
Magnavox	20035, 20037, 20048, 20039, 20081, 20000, 20149, 20563, 20593, 20618, 21593, 21781
Marantz	20035, 20081, 20038
Marta	20037
Matsui	20037, 20209
Matsushita	20035, 20162, 20081, 21162
Media Center PC	21972
MEI	20035
Memorex	20035, 20162, 20037, 20048, 20039, 20000, 20209, 20046, 20479, 21037, 21162, 21237, 21262
Metz	20037
MGA	20060, 20043
Microsoft	21972
Mind	21972
Minolta	20042
Mitsubishi	20060, 20048, 20000, 20042, 20067, 20043, 20807
Motorola	20035, 20048
MTC	20000
MTX	20000
Multitech	20039, 20000
NEC	20067, 20038
Nikko	20037

VCRs	
Nikkodo	20037
Niveus Media	21972
Northgate	21972
Olympus	20035, 20162
Optimus	21062, 20035, 20162, 20037, 20048, 20000, 20593, 21162, 21262
Orion	20184, 20000, 20121, 20209, 20479, 21479
Panama	20035
Panasonic	21062, 20035, 20162, 20000, 20225, 20614, 20616, 21035, 21162, 21262 Penney 20035, 20162, 20037, 20081, 20000, 20042, 20067, 20038, 21035, 21237
Pentax	20042
Philco	20035, 20081, 20000, 20209, 20479
Philips	20035, 20162, 20048, 20081, 20045, 20000, 20209, 20616, 20618, 20739, 21081, 21181
Pilot	20037
Pioneer	20162, 20081, 20042, 20067
Polk Audio	20081
Presidian	21593
Proscan	20060, 21060
Protec	20000
Pulsar	20039
Quarter	20046
Quartz	20035, 20046
Quasar	20035, 20162, 21035, 21162
RadioShack	20035, 20162, 20037, 20048, 20000, 20046, 21037, 21162
Radix	20037
Randex	20037
RCA	20060, 20035, 20048, 20045, 20000, 20042, 20149, 20807, 20880, 21035, 21060
Realistic	20035, 20162, 20037, 20048, 20000, 20121, 20046, 21162
ReplayTV	20614, 20616
Ricavision	21972
Runco	20039
Samsung	20060, 20045, 20000, 20038, 20739, 21014
Sanky	20048, 20039
Sansui	20000, 20067, 20209, 20479, 21479
Sanyo	20000, 20046, 20479
Scott	20184, 20045, 20121, 20043
Sears	20060, 20035, 20162, 20037, 20048, 20039, 20033, 20045, 20000, 20042, 20067, 20043, 20209, 20046, 21237
Sharp	20048, 20032, 20000, 20807, 20848
Shintom	20039, 20000
Siemens	20037
Signature	20060, 20035, 20037, 20048, 20000, 20149, 20046, 20479
Singer	20037
Sonic Blue	20614, 20616
Sonographe	20046
Sony	20035, 20032, 20033, 20000, 20067, 20046, 20636, 21032, 21232, 21972
Soundmaster	20000
Stack 9	21972
STS	20042
SV2000	20000
SVA	20000

VCRs	
Sylvania	20035, 20081, 20000, 20043, 20593, 21593, 21781
Symphonic	20000, 20593, 21593
Systemax	21972
Tagar Systems	21972
Tandy	20000
Tashiko	20037
Tatung	20048, 20081, 20000, 20067
Teac	20000, 20067
Technics	20035, 20162, 20037, 20000
Teknika	20035, 20037, 20000
Tevion	20479
Thomas	20000
Thomson	20060
Tivo	20618, 20636, 20739, 21996
TMK	20000
TNIX	20037
Toshiba	20045, 20000, 20043, 20209, 20845, 21008, 21145, 21972, 21996
Totevision	20037
Touch	21972
Trix	20037
Ultra	20045
Vector	20045
Vector Research	20184, 20038
Victor	20067
Video Concepts	20045
Videomagic	20037
Videosonic	20000
Viewsonic	21972
Villain	20000
Voodoo	21972
Wards	20060, 20035, 20037, 20048, 20081, 20033, 20045, 20000, 20042, 20043, 20038, 20149, 20046, 20479
Wharfedale	20593
White Westinghouse	20000, 20209, 20479
World	20209, 20479
XR-1000	20035, 20000
Yamaha	20038
Zenith	20037, 20039, 20033, 20000, 20209, 20479, 21479
ZT Group	21972

Video Accessories

Video Accessories	
2Wire	02045
ABS	01272
Access HD	02185
Accurian	01653
Alienware	01272
Amino	01481
AT&T	00858, 02045
Buffalo	01739
CASTi	02305
CyberPower	01272
D-Link	01554, 01731, 02186
Digital Stream	02303
Epson	01563

Video Accessories	
Gateway	01272
Hewlett Packard	01272, 01267
Howard Computers	01272
HP	01272, 01267
Hush	01272
iBUYPOWER	01272
Insignia	01415
KoolConnect	01481
LG	01415
Linksys	01272, 01365
Media	Center PC 01272
Microsoft	01272, 02049
Mind	01272
Motorola	00858, 01363, 01998
Netgear	02036
Niveus Media	01272
Northgate	01272
Panasonic	01120
Pioneer	01010
Ricavision	01272
Roku	01486
Samsung	01190, 01490
Scientific Atlanta	00858
Sensory Science	01126
Sharp	01010
SMC	01456
Sony	01272, 01324, 01364
Stack 9	01272
SureWest	01481
Sylvania	01563
Systemax	01272
Tagar Systems	01272
Toshiba	01272
Touch	01272
Viewsonic	01272, 01329
Vizio	01126
Voodoo	01272
VUDU	02298
Xbox	02049
Zenith	01415
ZT Group	01272

Maintaining

- Do not use your TV in areas that are too hot or too cold, because the cabinet may warp or the screen may malfunction. Your TV works best in temperatures that are comfortable to you.
- Storage temperatures are 32° to 122°F (0° to 50°C).
- Working temperatures are 41° to 104°F (5° to 40°C).
- Do not place your TV in direct sunlight or near a heat source.

Cleaning the TV cabinet

Clean the cabinet with a soft, lint-free cloth. **Do not** use the cleaning cloth that came with your TV to clean the cabinet. If the cabinet is especially dirty, moisten a soft, lint-free cloth in a weak detergent solution, squeeze the excess moisture from the cloth, then wipe the screen or cabinet with the cloth. Use a clean cloth to dry the screen or cabinet.

Cleaning the TV screen

Clean the screen with the cleaning cloth or a soft, lint-free cloth. **Do not** use the cleaning cloth to clean other parts of your TV.

Troubleshooting

Warning

Do not try to repair your TV yourself. Refer all service to a qualified service technician.

No power	<ul style="list-style-type: none"> • Make sure that the power cord is correctly connected to your TV and a power outlet. • Unplug the power cord, wait 60 seconds, then plug the cord back in and turn on your TV.
No picture	<ul style="list-style-type: none"> • Make sure that Audio Only option is set to Off. For more information, see "Playing TV audio only" on page 19. • Make sure that the video cables are connected securely to the back of your TV. • Adjust the contrast and brightness. • Make sure that the correct video mode is selected. • Make sure that the incoming signal is compatible. • Make sure the antenna is connected correctly. • Check the closed caption settings. Some TEXT modes can block the screen.
Good picture but no sound	<ul style="list-style-type: none"> • Increase the volume. • Make sure that the sound is not muted. • Make sure that the correct audio mode is selected.
Good sound but poor color	<ul style="list-style-type: none"> • Adjust the contrast, color, and brightness settings.
Poor picture	<ul style="list-style-type: none"> • Make sure that the room is not too bright. Light reflecting off the screen can make the picture difficult to see. • If an S-VHS camera or a camcorder is connected while another connected device is turned on, the picture may be poor. Turn off one or more devices.
Horizontal dotted line	<ul style="list-style-type: none"> • Your TV may be too close to another electrical device, such as a hair dryer or neon light. Turn off the device or move your TV.
"Ghost" or double image	<ul style="list-style-type: none"> • This may be caused by obstructions to the antenna, such as high-rise buildings or hills. Use of a highly directional antenna may improve the picture quality.

Remote control does not work	<ul style="list-style-type: none"> • Press TV (not the color button) • Replace the batteries. Make sure that the + and – symbols on the batteries align with the + and – symbols in the battery compartment. • Clean the remote sensor on the front of your TV. • Bright or fluorescent lighting may interfere with the remote control signal. Turn off the light or move your TV.
Snowy picture or noise	<ul style="list-style-type: none"> • Make sure that the A/V and antenna cables are connected correctly and securely.
VGA picture is not stable or synchronized	<ul style="list-style-type: none"> • Make sure that you have selected the correct VGA mode on your computer.
No output from one of the speakers	<ul style="list-style-type: none"> • Adjust the balance in the <i>Audio</i> menu.
Control buttons do not work	<ul style="list-style-type: none"> • Make sure that the Button Lock option is set to Off. For more information, see “Locking control buttons” on page 26. • Unplug the power cord, wait a few seconds, then plug the cord back in and turn on your TV.
After images appear	<ul style="list-style-type: none"> • Do not display a still image, such as a logo, game, or computer image, for an extended period of time. This can cause a permanent after-image to be burned into the screen. This type of damage is not covered by your warranty.
Picture has a few bright or dark dots	<ul style="list-style-type: none"> • A few bright or dark dots on an LCD screen is normal. It does not affect the operation of this TV.

Specifications

Design and specifications are subject to change without notice.

Analog standard	NTSC
Digital standard	ATSC, 8-VSB, Clear-QAM
Screen	NS-L37Q-10A: 37" NS-L42Q-10A: 42"
Channel coverage	VHF: 2-13 UHF: 14-69 CATV: Mid band - A-8 ~ A-1, A ~ I Super band - J ~ W Hyper band - AA ~ ZZ, AAA, BBB Ultra band - 65 ~ 94, 100 ~ 135
Power source	AC 120 V ~ 60 Hz
Power consumption	37": 220 W with TV on 42": 250 W with TV on <1 W in standby mode
Audio power	12 W + 12 W internal speaker
S-Video input (2)	Y: 1 V (p-p), 75 ohm, negative sync C: 0.286 V (p-p) (burst signal), 75 ohm
Video/audio input (2)	Video: 1 V (p-p), 75 ohm, negative sync Audio: 300 mV (rms)
Component input (2)	Y: 1 V (p-p), 75 ohm, including sync Pr/Cr: ±0.35 V (p-p), 75 ohm Pb/Cb: ±0.35 V (p-p), 75 ohm Audio: 300 mV (rms) Suggested resolutions: 1080p, 1080i, 720p, 480p, 480i
HDMI input (4)	4 HDMI input jacks HDCP compliant E-EDID compliant Suggested scan rates: 1080p, 1080i, 720p, 480p, 480i
VGA input	E-EDID compliant Suggested scan rates: 640x480/60 Hz, 800x600/60 Hz, 1024x768/60 Hz, 1920x1080/60 Hz Audio input: Headphone mini-jack for stereo
Accessories	Remote control and batteries (2 AA) Remote control holder AC power cord Component cable Cleaning cloth <i>User guide</i> <i>Quick Setup Guide</i>

Legal notices

FCC Part 15

This device complies with Part 15 of the FCC Rules. Operation of this product is subject to the following two conditions: (1) this device may not cause harmful interference, and (2) this device must accept any interference received, including interference that may cause undesired operation.

This equipment has been tested and found to comply within the limits for a class B digital device, pursuant to Part 15 of the FCC Rules. These limits are designed to provide reasonable protection against harmful interference in a residential installation. This equipment generates, uses, and can radiate radio frequency energy and, if not installed and used in accordance with the instructions, may cause harmful interference to radio communications. However, there is no guarantee that interference will not occur in a particular installation. If this equipment does cause harmful interference to radio or television reception, which can be determined by turning the equipment off and on, the user is encouraged to try to correct the interference by one or more of the following measures:

- Reorient or relocate the receiving antenna.
- Increase the separation between the equipment and receiver.
- Connect the equipment into an outlet on a circuit different from that to which the receiver is connected.
- Consult the dealer or an experienced technician for help.

FCC warning

Changes or modifications not expressly approved by the party responsible for compliance with the FCC Rules could void the user's authority to operate this equipment.

Cables

Connections to this device must be made with shielded cables with metallic RF/EMI connector hoods to maintain compliance with FCC Rules and Regulations.

Canadian notice

This Class B digital apparatus complies with Canadian ICES-003. Cet appareil numérique de la classe B est conforme à la norme NMB-003 du Canada.

"Standard Television Receiving Apparatus-Appareil de réception télévision ordinaire, Canada BETS-7 / NTMR-7".

Dolby License Notice and Trademark Acknowledgement



Manufactured under license from Dolby Laboratories. "Dolby" and the double-D symbol are trademarks of Dolby Laboratories.

HDMI



HDMI, the HDMI logo, and High-Definition Multimedia Interface are trademarks or registered trademarks of HDMI Licensing LLC.

SRS TruSurround HD



is a trademark of SRS Labs, Inc.

TruSurround HD technology is incorporated under license from SRS Labs, Inc.

Two-year limited warranty

Insignia Products ("Insignia") warrants to you, the original purchaser of this new **NS-L37Q-10A/NS-L42Q-10A** ("Product"), that the Product shall be free of defects in the original manufacture of the material or workmanship for a period of two (2) years from the date of your purchase of the Product ("Warranty Period"). This Product must be purchased from an authorized dealer of Insignia brand products and packaged with this warranty statement. This warranty does not cover refurbished Product. If you notify Insignia during the Warranty Period of a defect covered by this warranty that requires service, terms of this warranty apply.

How long does the coverage last?

The Warranty Period lasts for 2 years (730 days) from the date you purchased the Product. The purchase date is printed on the receipt you received with the Product.

What does this warranty cover?

During the Warranty Period, if the original manufacture of the material or workmanship of the Product is determined to be defective by an authorized Insignia repair center or store personnel, Insignia will (at its sole option): (1) repair the Product with new or rebuilt parts; or (2) replace the Product at no charge with new or rebuilt comparable products or parts. Products and parts replaced under this warranty become the property of Insignia and are not returned to you. If service of Products or parts are required after the Warranty Period expires, you must pay all labor and parts charges. This warranty lasts as long as you own your Insignia Product during the Warranty Period. Warranty coverage terminates if you sell or otherwise transfer the Product.

How to obtain warranty service?

If you purchased the Product at a retail store location, take your original receipt and the Product to the store you purchased it from. Make sure that you place the Product in its original packaging or packaging that provides the same amount of protection as the original packaging. If you purchased the Product from an online web site, mail your original receipt and the Product to the address listed on the web site. Make sure that you put the Product in its original packaging or packaging that provides the same amount of protection as the original packaging.

To obtain in-home warranty service for a television with a screen 30 inches or larger, call 1-888-BESTBUY. Call agents will diagnose and correct the issue over the phone or will have an Insignia-approved repair person dispatched to your home. Should the Insignia-approved repair person not correct the issue on the first call, an Insignia television (size and features to be determined by Insignia) will be loaned to you until your TV is repaired and returned, at no charge to you. This feature is only available to Insignia television consumers residing in the United States.

Where is the warranty valid?

This warranty is valid only to the original purchaser of the product in the United States, Canada, and Mexico.

What does the warranty not cover?

This warranty does not cover:

- Customer instruction
- Installation
- Set up adjustments
- Cosmetic damage
- Damage due to acts of God, such as lightning strikes
- Accident
- Misuse
- Abuse
- Negligence
- Commercial use
- Modification of any part of the Product, including the antenna
- Plasma display panel damaged by static (non-moving) images applied for lengthy periods (burn-in).

This warranty also does not cover:

- Damage due to incorrect operation or maintenance
- Connection to an incorrect voltage supply
- Attempted repair by anyone other than a facility authorized by Insignia to service the Product
- Products sold as is or with all faults
- Consumables, such as fuses or batteries
- Products where the factory applied serial number has been altered or removed

REPAIR REPLACEMENT AS PROVIDED UNDER THIS WARRANTY IS YOUR EXCLUSIVE REMEDY. INSIGNIA SHALL NOT BE LIABLE FOR ANY INCIDENTAL OR CONSEQUENTIAL DAMAGES FOR THE BREACH OF ANY EXPRESS OR IMPLIED WARRANTY ON THIS PRODUCT, INCLUDING, BUT NOT LIMITED TO, LOST DATA, LOSS OF USE OF YOUR PRODUCT, LOST BUSINESS OR LOST PROFITS. INSIGNIA PRODUCTS MAKES NO OTHER EXPRESS WARRANTIES WITH RESPECT TO THE PRODUCT, ALL EXPRESS AND IMPLIED WARRANTIES FOR THE PRODUCT, INCLUDING, BUT NOT LIMITED TO, ANY IMPLIED WARRANTIES OF AND CONDITIONS OF MERCHANTABILITY AND FITNESS FOR A PARTICULAR PURPOSE, ARE LIMITED IN DURATION TO THE WARRANTY PERIOD SET FORTH ABOVE AND NO WARRANTIES, WHETHER EXPRESS OR IMPLIED, WILL APPLY AFTER THE WARRANTY PERIOD. SOME STATES, PROVINCES AND JURISDICTIONS DO NOT ALLOW LIMITATIONS ON HOW LONG AN IMPLIED WARRANTY LASTS, SO THE ABOVE LIMITATION MAY NOT APPLY TO YOU. THIS WARRANTY GIVES YOU SPECIFIC LEGAL RIGHTS, AND YOU MAY ALSO HAVE OTHER RIGHTS, WHICH VARY FROM STATE TO STATE OR PROVINCE TO PROVINCE.

Contact Insignia:

For customer service please call 1-877-467-4289
www.insigniaproducts.com

Distributed by Best Buy Purchasing, LLC
7601 Penn Avenue South, Richfield, Minnesota, U.S.A.
55423-3645

© 2010 BBY Solutions, Inc.

All rights reserved. INSIGNIA is a trademark of BBY Solutions, Inc. Registered in some countries. All other products and brand names are trademarks of their respective owners.

INSIGNIA™

www.insigniaproducts.com (877) 467-4289

Distributed by Best Buy Purchasing, LLC
7601 Penn Avenue South, Richfield, MN USA 55423-3645
© 2010 BBY Solutions, Inc.

All rights reserved. INSIGNIA is a trademark of BBY Solutions, Inc. Registered in some countries.
All other products and brand names are trademarks of their respective owners.



ENGLISH
10-0783