

P40 Lite

■ 3-Axis Gimbal 4K Camera Drone

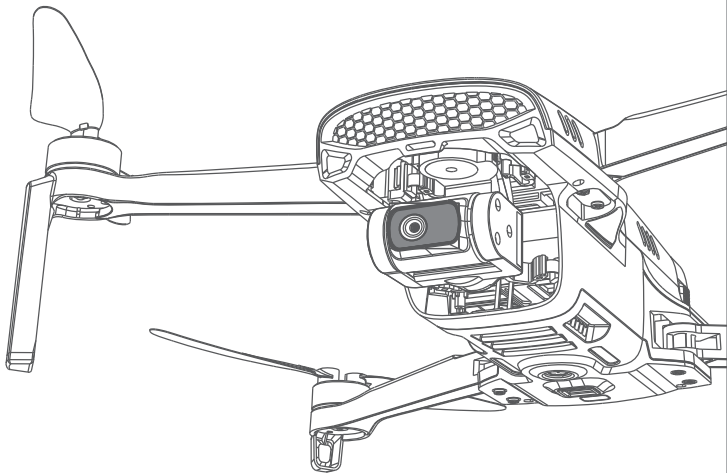

USER MANUAL

Please read this manual carefully before flying and keep it for future use.

- For your safety, please follow the rules and safety guidelines whether you're a beginner or an expert at flying drones.
- According to the relevant laws and regulations in US, all drones must be registered, except those that weigh 0.55 pounds or less (less than 250 grams) and are flown exclusively under the Exception for Recreational Flyers. Please log in to the website of <https://faadronezone-access.faa.gov/#/> to complete the registration. Make sure to observe local laws and regulations about the take-off weight. If the buyer does not register timely, SNAPTAIN will not be responsible for any losses, penalties and injuries caused by illegal flights.
- To meet the electromagnetic requirements of aviation on the radio station, it is forbidden to fly drones within 6.21 miles(10km) on both sides of the runway centerline, or within 12.43 miles(20km) of both ends of the runway. It is also prohibited to fly a drone on the route of an airline. In the area that is prohibited by the relevant authority or department of your country, stop using all flying models and unmanned quadrotors.
- Please download the B4UFLY App from Google Play or App Store, which provides real-time information about airspace restrictions and other flying requirements based on your GPS location.

ENGLISH



AIM HIGH FLY HIGH

Thank you for choosing our product and putting your trust in us.

Contact us via email at

support@snaptain.com or call us **(415)991-6646(Mon-Fri)**
if you have questions or concerns about the product.

We hope our products will make flying a whole new experience for you!

Please read the manual carefully for the best use of this product.

CONTENTS

FLIGHT SAFETY	01
BATTERY SAFELY	02
WHAT'S INCLUDED	04
PRODUCT OVERVIEW	05
DRONE	05
REMOTE	07
CHARGING THE DRONE BATTERY & REMOTE	08
DOWNLOADING APP	09
FLIGHT PREPARATION	09
OPERATION & FUNCTIONS	13
SPECIFICATIONS	22
DRONE	22
CAMERA	23
GIMBAL	24
REMOTE	24

FLIGHT SAFETY

*Please fly the drone indoors or in a windless, open area. The maximum flight height is limited to **400 ft (120 m)**, and the maximum flight distance is limited to **20,000 ft (6,000 m)**. Before your first flight, please read the **User Manual** and **Quick Guide** carefully. For detailed operations, refer to the **OPERATION & FUNCTIONS** section.



1. Do not use the drone in bad weather conditions like rain, snow, fog, wind, smoke, hail, lightning, tornadoes, or hurricanes.
2. For the safety of your property, keep the drone within your visual range during flight.
3. The drone is made of materials including metal, fiber, plastic, and electronic components. Avoid prolonged exposure to direct sunlight and keep them away from any heat sources. Excessive heat can cause deformation and damage.
4. The drone consists of various precision electronic and mechanical parts. Therefore, make sure that moisture and water do not enter the drone to prevent mechanical or electronic component failures that could lead to accidents.
5. The performance of the drone and battery can be affected by environmental factors such as air density and temperature. Exercise caution when flying at altitudes above 10,000 ft (3,000 m) above sea level, as the performance of the battery and drone may be reduced.
6. Do not use the drone near traffic accidents, fires, explosions, floods, tsunamis, avalanches, landslides, earthquakes, dust storms, or sandstorms.
7. To avoid interference between the drone and other wireless devices, please turn off other wireless devices while using the drone.
8. Avoid flying in areas where magnetic or radio interference may occur, such as near Wi-Fi hotspots, routers, Bluetooth devices, high-voltage power lines, high-voltage power transmission stations, mobile base

stations, or broadcast towers. Flying in areas where interference can disrupt communication between the drone and remote may adversely affect flight direction and positioning accuracy, possibly resulting in loss of control. Interference can also cause errors in the video downlink connection.

BATTERY SAFETY

- RISK OF EXPLOSION BATTERY IS REPLACED BY AN INCORRECT TYPE
- DISPOSE OF USED BATTERIES ACCORDING TO THE INSTRUCTIONS
- BATTERY MUST BE RECYCLED OR DISPOSED OF PROPERLY
- Under no circumstances should the battery touch any liquids. Avoid using the battery in rainy or wet conditions, as it may catch fire or explode unexpectedly.
- It is not allowed to use batteries that are not provided by the manufacturer. Additionally, it is advisable to use the package-included USB charging cable to charge the batteries.
- Batteries that are swollen, leaking, or damaged are strictly forbidden.
- It is recommended to use the battery between 32°F-104°F (0°C-40°C) overheating may lead to a fire or explosion. A battery's performance can be adversely affected by extremely low temperatures.
- Do not insert or puncture the battery with any sharp object.
- Battery liquid is highly corrosive, so stay away if it leaks. If skin or eyes are contacted, rinse immediately with plenty of water and seek medical attention.
- Please keep the battery out of children's reach. Immediately seek medical attention if a child swallows parts.
- After being dropped or impacted, the battery should not be used again.
- Place the battery away from heat sources, such as a car in direct sunlight or on a hot day, a fire or a stove.
- To prevent a battery from entering an over-discharged state, avoid storing it for extended periods of time once it has been fully discharged. If a battery is over-discharged, the battery cell will be damaged and unable to be recharged.



+



+



+



Fly in Open
Areas

Strong GPS
Signal

Maintain Line
of Sight

Maximum flight
altitude height is
about 400ft(120m)



Avoid flying over or near obstacles, crowds, high-voltage power lines, trees, airports, or water areas.

DO NOT fly near strong electromagnetic sources such as power lines and base stations as they may affect the onboard compass.



DO NOT use the drone in adverse weather conditions such as rain, snow, fog, and wind speeds exceeding 8-10.7 m/s.

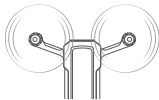

Stay away from the rotating
propellers and motors



No Fly Zone



For your safety and that of those people around you, it's important to understand basic flight guidelines. Before flying, make sure you read the safety precautions.

WHAT'S INCLUDED



Drone x1



Remote x1



Battery x1

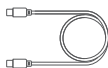

USB Charging Cable x1



Screws



Screwdriver x1



Spare Propellers x8
(Clockwise x 4,
Counterclockwise x 4)



Remote Connection
Cables x3
(USB-C, Lightning
& Micro-USB)



User Manual x1



Quick Guide x1

PRODUCT OVERVIEW

1. Drone

- ① Gimbal Cover
(Remove before Flight)
- ② Gimbal Camera
- ③ Three-Axis Gimbal
- ④ Motor
- ⑤ Counterclockwise Propeller (↺)
- ⑥ Clockwise Propeller (↻)
- ⑦ Front Arm
- ⑧ Rear Arm
- ⑨ ToF Sensor
- ⑩ Optical Flow Sensor
- ⑪ Status Indicator Light
- ⑫ Battery
- ⑬ Battery Indicator Lights
- ⑭ Power Button
- ⑮ Charging Port
- ⑯ Micro SD Card Slot

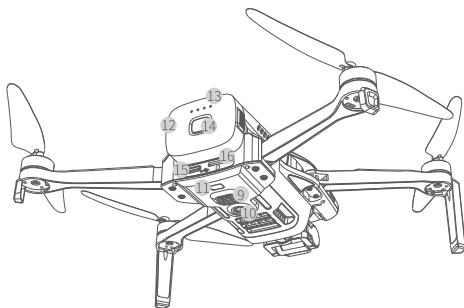
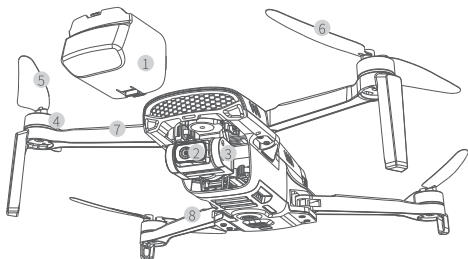

*How to Replace the Propeller

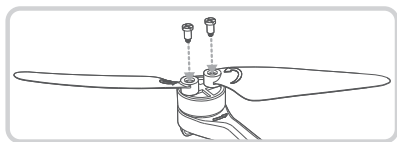
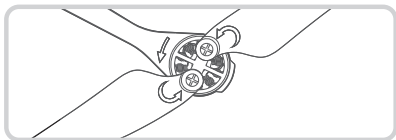
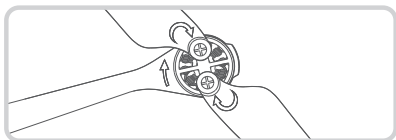
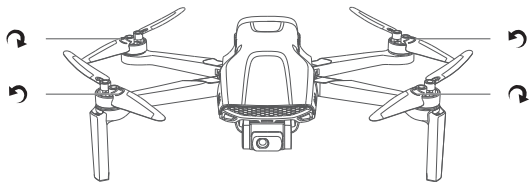

- Use a screwdriver to remove the propeller screw and then take off the propeller.
- Install a new propeller. Ensure the rotation direction mark (clockwise or counterclockwise) on the propeller match the mark on the arm.
- Securely tighten the screw.

2. Remote

- 1 Antennas
- 2 System Status Light
- 3 Return to Home (RTH) Button
- 4 Left Control Stick
- 5 Power Button
- 6 Foldable Handle
- 7 Stick Storage Slots
- 8 Battery Indicator Lights
- 9 Right Control Stick
- 10 USB-C Port
(For Phone Connection)
- 11 Speed Switch Button
- 12 Secondary Control Stick
- 13 Photo Button
- 14 Gimbal Tilt Dial
- 15 Video Button
- 16 FN Button (Customize in App)
- 17 USB-C Charging Port

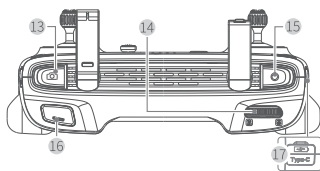
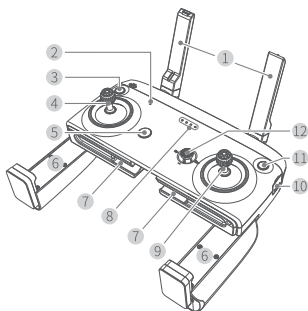

CHARGING THE DRONE BATTERY & REMOTE

Drone Battery

The battery features a USB-C charging port (compatible with standard USB-C connectors). Before charging, install the battery into the drone. Then, use the included USB-C charging cable and a PD 3.0 or QC 3.0 charger to charge the battery.

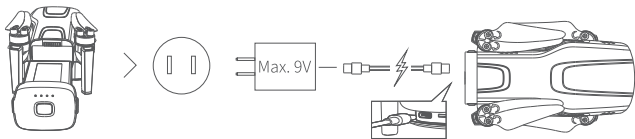

- Charging: Battery indicator lights flash green.
- Fully charged: Battery indicator lights extinguish.
- Low battery: A single indicator light flashes green.

Notes

- After flight, the battery may be hot. Allow it to cool to room temperature before charging.
- It's not recommended to charge the battery using a computer's USB port.
- When flying in low-temperature environments, the flight time of the drone may be reduced.

Remote

The remote features a USB-C charging port (compatible with standard USB-C connectors). Use the included USB-C charging cable and a PD 3.0 or QC 3.0 charger to charge the remote.

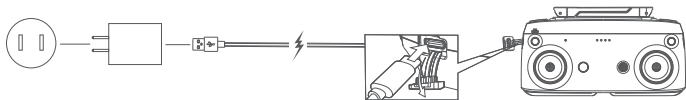

- Charging: Battery indicator lights flash green.
- Fully charged: Battery indicator lights extinguish.

DOWNLOADING APP

To control your drone, download and install the official **SNAPTAIN GO** app from the Google Play™ or App Store™. You can also scan the QR code below for quick access.



For Android 10.0 and later



For iOS 10.0 and later

FLIGHT PREPARATION

1. Insert a Micro SD card (purchased separately).

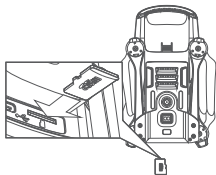

- * Supports up to 256GB
- * Supports FAT32 and exFAT formats

Note

Photos/videos cannot be saved without a Micro SD card.

2. Remove the gimbal cover.

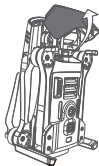

3. Install the drone battery.



4. Extend the front arms, rear arms, and propellers.

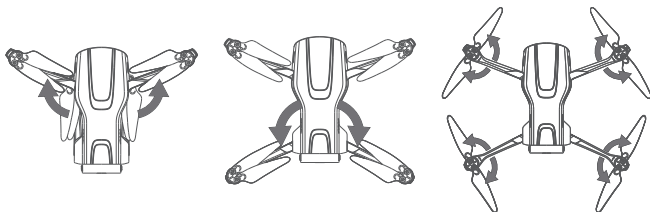

5. Unfold the handles and antennas.

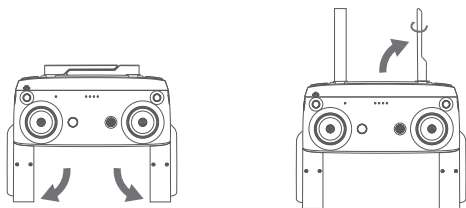

6. Remove the control sticks from their storage slots and mount them to the remote.

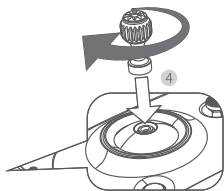
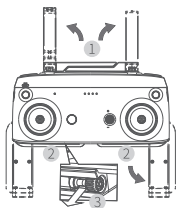

7. Extend the phone holder and insert your phone with its charging port facing right, then connect the phone to the Type-C port on the right side of the remote using the appropriate connection cable (USB-C/ Lightning/Micro-USB) from the package.

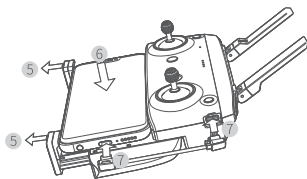

Tip

The phone holder can accommodate phones up to 3.54 inches (90 mm) wide.

8. Power on the remote by pressing the **Power** button once, then holding it until all battery indicator lights illuminate.

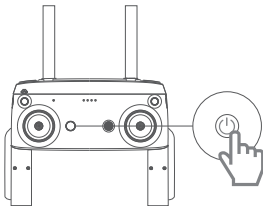

9. Power on the drone by pressing the **Power** button once, then holding it until all battery indicator lights illuminate.

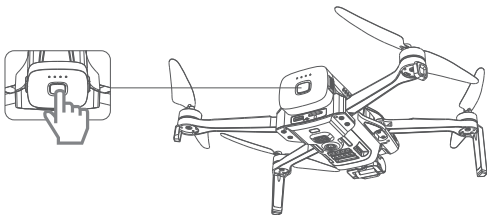

10. Place the drone on a level surface. The drone will automatically pair with the remote, indicated when the remote's system status light changes from red to green.
11. Launch the app and wait for the connection status to update. Once **Disconnected** changes to **Connected** on the screen, tap the **START** button to access the live control interface.
12. After powering on, the drone will automatically search for GPS satellite signals. Check the GPS signal status on the live control interface in the app. When the number of satellites exceeds 10  **10**, the drone is ready for takeoff. If the icon appears red or yellow, the GPS signal is weak, and takeoff is not advised.

Notes

- * For stronger GPS signals, fly the drone in open outdoor areas. Avoid indoor or densely built-up locations, as the signal may be weak.
- * If the drone takes off with poor GPS signal, it will switch to attitude mode. In this mode, flight distance and height are limited, stability may decrease, and some app features may not work. Fly carefully in such conditions.

OPERATION & FUNCTIONS

Take-off

Option 1: Using Remote

Unlock the drone by simultaneously pushing the **Left Control Stick** to the lower right at 45° angle and the **Right Control Stick** to the lower left at 45° angle (or **Left Control Stick** to the lower left and **Right Control Stick** to the lower right) until the propellers start rotating. Then, push the **Left Control Stick** forward.

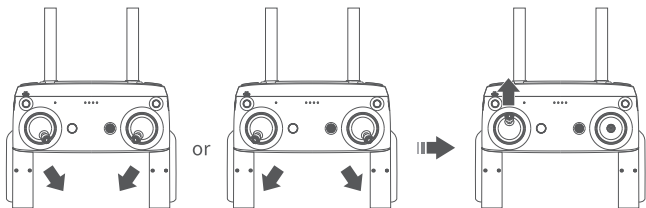

Option 2: Using One-Key Takeoff

When the **Be Ready** prompt shows in the top-left corner of the app screen, tap the **One-Key Takeoff** icon  on the left. Tap and hold to confirm, and the drone will automatically take off, ascending to a height of 6.5ft (2m) and hovering in place.

Option 3: Throwing away

1. On the app screen, tap "..." in the top-right corner, select **Control** and scroll to the bottom to find **Throwing away**. Tap to enable the feature.
2. When the **Be Ready** prompt shows in the top-left corner of the app screen, hold the drone from the bottom and tilt it vertically downward (head facing down) for 2-3 seconds. The drone will emit "ding-dong ding-dong" sounds, indicating it is ready for takeoff.

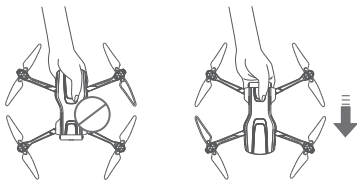

3. Toss the drone upward or forward, and it will automatically stabilize and hovering in place.

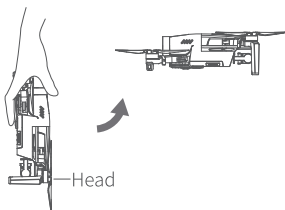

Notes

- * Perform the **Throwing away** function in an open area, keeping a safe distance from people and objects.
- * Ensure a proper grip when using the **Throwing away** function. Do not grab the drone from the top or hold the propellers, as this may cause injury or damage.
- * Once the drone emit sounds, throw it within 10 seconds, or it will automatically exit **Throwing away** mode.
- * Do not throw the drone downward or hold onto it after throwing. Toss it upward or horizontally for proper takeoff.
- * When not using the **Throwing away** function, disable it in the app to prevent accidental activation during regular use.

Flight Directions

The remote features 3 modes. The default mode is **Mode 1** (used for manual illustration). You can switch the remote mode in the app.

Mode 1

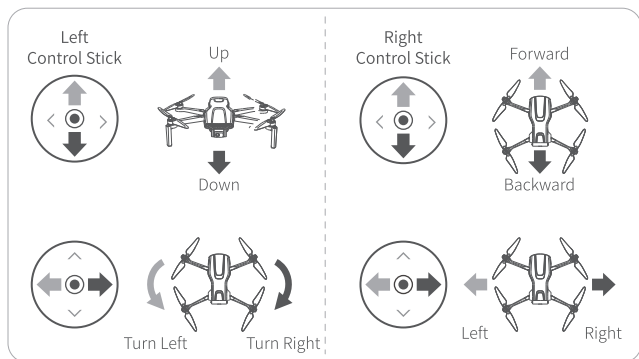

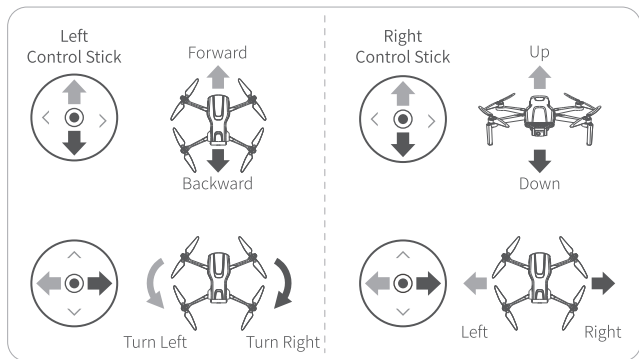

Mode 2



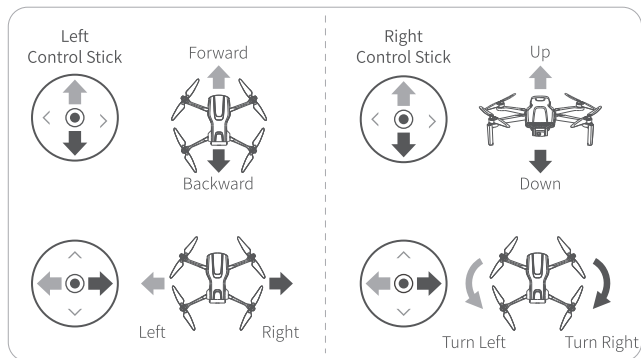

Mode 3



Return to Home (RTH)

To activate RTH, press and hold the RTH button  on the remote or tap the RTH/Landing icon  on the app screen and select RTH.

Tips

- * The drone will automatically activate RTH if the battery level becomes critically low or if it loses connection with the remote.
- * If the drone detects more than 10 GPS satellites at takeoff, it will record the launch position as the return point. If GPS signals are weak (< 10) at takeoff but improve (> 10) during flight at a point, this point will be updated as the return point.
- * You can manually customize the return point on the app's map and set the RTH altitude in the settings menu.
- * You can cancel the return by pressing and holding the RTH button  on the remote or tapping the Cancel icon  on the app screen.
- * When the drone is within 16.4ft (5m) of its home point, the app will only allow landing at the current position (RTH disabled).

Landing

Option 1: Using Remote

Pull the left control stick fully backward to make the drone descend and land.

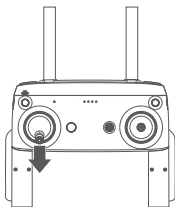

Option 2: Using App

In the app, tap the RTH/Landing icon , then select **Land**. The drone will descend and land at its current position.

Taking Photos & Recording Videos

Using the Remote Control

Taking Photos: Press the  button on the top-left side of the remote to take photos and save to the SD card.

Recording Videos: Press the  button on the top-right side of the remote to start recording a video. Press it again to stop and save to the SD card.

Using the App

Taking Photos:

Step 1: Tap the  icon on the app screen to switch to **Photo** mode.

Step 2: Tap the  icon or pinch/spread on the screen to adjust zoom level.

Step 3: Tap the  button to capture a photo.

Recording Videos:

Step 1: Tap the  icon on the app screen to switch to **Video** mode.

Step 2: Tap the  icon or pinch/spread on the screen to adjust zoom level.

Step 3: Tap the  button to start recording. Tap it again to stop and save the video.

Gimbal Tilt

Adjust the gimbal's angle by scrolling the **Gimbal Tilt** dial on the top-left side of the remote. Press the **FN** button on the top-right of the remote to instantly toggle the gimbal between 0° and -90°.

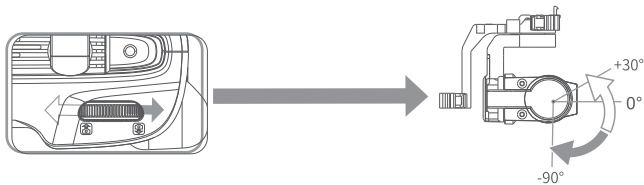



Note

Avoid shaking or impacting the drone to prevent gimbal malfunctions (abnormal rotation/jamming), and recalibrate if needed by going to **Settings** ··· > **Camera** > **Gimbal Calibration** in the app.

Intelligent Shooting Modes

Circle

This mode enables the drone to orbit the target while recording a video until it completes the preset number of circles.

Step 1: During flight, tap the **Flight Menu** icon  on the app screen and select **Circle** .

Step 2: Select rotation direction (clockwise or counterclockwise).

Step 3: Set the number of circles.

Step 4: Adjust the drone's position, orientation, and gimbal angle using the remote.



Step 5: Align the “+” marker in the app with your target, or manually frame the target.

Step 6: Tap **Start**.

To stop this mode, simply press **Stop**.

Soaring

This mode enables the drone to vertically ascend while recording a video, maintaining camera lock on the target until reaching the preset height.

Step 1: During flight, tap the **Flight Menu** icon  on the app screen and select **Soaring** .

Step 2: Set the height.

Step 3: Adjust the drone's position, orientation, and gimbal angle using the remote.

Step 4: Align the “+” marker in the app with your target, or manually frame the target.

Step 5: Tap **Start**.

To stop this mode, simply press **Stop**.

Gradual Retreat

This mode enables the drone to fly backward and upward while recording a video, maintaining camera lock on the target until reaching the preset distance.

Step 1: During flight, tap the **Flight Menu** icon  on the app screen and select **Gradual Retreat** .

Step 2: Set the retreat distance.

Step 3: Adjust the drone's position, orientation, and gimbal angle using the remote.

Step 4: Align the “+” marker in the app with your target, or manually frame the target.

Step 5: Tap **Start**.

To stop this mode, simply press **Stop**.

Drift

This mode enables the drone to fly toward a target, reach a position above it, then rotate 180° and fly backward.

Step 1: During flight, tap the **Flight Menu** icon  on the app screen and select **Drift** .

Step 2: Adjust the drone's position, orientation, and gimbal angle using the remote.

Step 3: Align the “+” marker in the app with your target, or manually frame the target.

Step 4: Tap **Start**.

To stop this mode, simply press **Stop**.

Time-Lapse

This mode enables the drone to automatically take a series of photos at set intervals within the specified duration and compile them into a time-lapse video. This function can be used both when the drone's not flying and during flight.

Step 1: Tap the **Flight Menu** icon  on the app screen and select **Time-Lapse** .

Step 2: Set the interval and video duration.

Step 3: Tap **Start**.

To stop this mode, simply press **Stop**.

Smart Follow

Follow: The drone follows the target while keeping a fixed distance from the target, holding a constant height, and always facing directly toward the target.

Follow Parallel: The drone follows the target while moving along a parallel path. It maintains its original heading direction, distance, and height.

Step 1: Tap **Flight Menu** icon  on the app screen and select **Smart Follow** .

Step 2: Choose a mode **Follow**  or **Follow Parallel** .

Step 3: Adjust the drone's position, orientation, and gimbal angle (Flight height $\geq 5\text{m}$, gimbal angle $\leq -10^\circ$) using the remote.

Step 4: Align the “+” marker in the app with your target, or manually frame the target.

Step 5: Tap **Start**.

To stop this mode, simply press **Stop**.

Speed Switch

Switch between three speed modes (Smooth, Normal, Sport) by pressing the **Speed Switch** button on the remote. You can view and adjust each mode's exact speed settings in the app.



Speed Cruise Control

The Speed Cruise Control feature is recommended for long-distance flights or when executing specific camera movements. When activated, this function will lock and maintain the drone's current vertical speed, horizontal speed, or rotation rate for consistent flight performance. This is particularly useful for capturing smooth, uninterrupted footage.

To enable the function, press the **FN** button on the top-right side of the remote twice during flight. Adjust the cruising speed by pushing the secondary control stick upward or downward.

To exit this mode, press the **FN** button twice or push the **left control** stick fully forward.

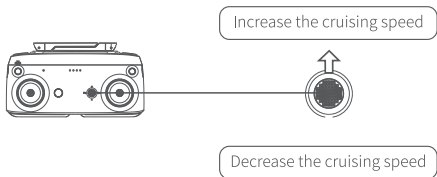

Magnetometer Calibration

Regular magnetometer calibration is essential for maintaining flight stability and accuracy. You should perform calibration when:

- The app displays a warning about severe magnetic interference.
- The drone exhibits circular movements while hovering.
- The drone veers off course during straight-line flight.

When any of these symptoms occur, immediately land and calibrate the drone by navigating to “...” in the upper right corner > **Safety** > **Compass** on the app screen.

SPECIFICATIONS

Drone

Model	DR-STP41G
Weight (with battery installed)	8.8 oz (249g)
Max.Flight Time	31 minutes (tested under 9.8 ft/s (3 m/s) cruising speed in windless conditions)
Operating Temperature	32-104°F (0-40°C)
Dimensions (Unfolded)	12.5x10.6x2.4 inches (317x270x62 mm)
Horizontal Flight Speed (no wind)	Smooth: 16.4 ft/s (5 m/s); Normal: 32.8 ft/s (10 m/s); Sport: 49.2 ft/s (15 m/s)
Max. Ascent/Descent Speed	16.4 ft/s (5 m/s)
Max Flight Height	400 ft (120 m)
Max. Flight Distance	20,000 ft (6,000m)
Battery Capacity	7.7V / 2250mAh-(Li Po)
Charging Time	In drone: 120 minutes Charging hub: 90 minutes
Input Voltage	In drone: Max. 9V=3A Charging hub: Max. 12V=3A

Camera

Sensor	1/2.0-inch CMOS; Effective Pixels: 48MP
FOV	78°
Focal Length	4.806mm
Aperture	F/2.6
ISO Range	100-1600
Electronic Shutter	1/30s-1/10,000s
Photo Resolution	Max: 8000*6000 pixels; UHD: 3840*2160 pixels
Video Resolution	FHD: 1920*1080P@60fps; UHD: 3840*2160P@30fps
Zoom	4x Digital Zoom
Supported File Formats	Photo: JPG; Video: MP4
Supported File Systems	FAT32, exFAT
Supported Storage	Micro SD card (up to 256GB)
Operating Frequency	5.725-5.850 GHz
Protocol Supported	IEEE 802.11 a/n

Gimbal

Stabilization System	3-axis (Pitch, Yaw, Roll)
Rotation Range	-90° to +30° (Pitch)
Max Control Rotation Speed	100°/s (Pitch)
Angle Control Precision	Static: $\pm 0.01^\circ$; Dynamic: $\pm 0.02^\circ$; Stabilization: $\pm 0.01^\circ$

Remote

Dimensions (Folded)	6x1.85x3.2 inches (152.5x47x82mm)
Operating Frequency	4.9 GHz - 5.9 GHz
Weight	8.9 oz (252g)
Max. Operating Distance	20,000 ft (6,000m)
Battery	3.7V 3900mAh
Charging Voltage	5V
Charging Time	≈ 150 minutes
Applicable Mobile Phone Size	Up to 3.54 inches (90mm)

FCC Caution:

Any Changes or modifications not expressly approved by the party responsible for compliance could void the user's authority to operate the equipment.

This device complies with part 15 of the FCC Rules. Operation is subject to the following two conditions:

(1) This device may not cause harmful interference, and (2) this device must accept any interference received, including interference that may cause undesired operation.

Note: This equipment has been tested and found to comply with the limits for a Class B digital device, pursuant to part 15 of the FCC Rules. These limits are designed to provide reasonable protection against harmful interference in a residential installation. This equipment generates, uses and can radiate radio frequency energy and, if not installed and used in accordance with the instructions, may cause harmful interference to radio communications. However, there is no guarantee that interference will not occur in a particular installation. If this equipment does cause harmful interference to radio or television reception, which can be determined by turning the equipment off and on, the user is encouraged to try to correct the interference by one or more of the following measures:

- Reorient or relocate the receiving antenna.
- Increase the separation between the equipment and receiver.
- Connect the equipment into an outlet on a circuit different from that to which the receiver is connected.
- Consult the dealer or an experienced radio/TV technician for help.

For Remote:

This equipment complies with FCC radiation exposure limits set forth for an uncontrolled environment.

For R/C QUADCOPTER:

This equipment complies with FCC radiation exposure limits set forth for an uncontrolled environment .

This equipment should be installed and operated with minimum distance 20cm between the radiator& your body.

This transmitter must not be co-located or operating in conjunction with any other antenna or transmitter.

ISED Warning:

This device complies with Innovation, Science, and Economic Development Canada licence-exempt RSS standard(s). Operation is subject to the following two conditions:

(1) this device may not cause interference, and
 (2) this device must accept any interference, including interference that may cause undesired operation of the device.

Le présent appareil est conforme aux CNR d' Innovation, Sciences et Développement économique Canada applicables aux appareils radio exempts de licence. L'exploitation est autorisée aux deux conditions suivantes :

(1) l'appareil n' doit pas produire de brouillage, et
 (2) l'utilisateur de l'appareil doit accepter tout brouillage radioélectrique subi, même si le brouillage est susceptible d'en compromettre le fonctionnement.

For R/C QUADCOPTER:

The device is compliance with RF exposure guidelines, users can obtain Canadian information on RF exposure and compliance. The minimum distance from body to use the device is 20cm.

Le présent appareil est conforme. Après examen de ce matériel aux normes de conformité ou aux limites d'intensité de champ RF, les utilisateurs peuvent sur l'exposition aux radiofréquences et la conformité et la conformité d'acquiescer les informations correspondantes. La distance minimale du corps à utiliser le dispositif est de 20cm.

For REMOTE:

The device is compliance with RF exposure guidelines, users can obtain Canadian information on RF exposure and compliance.

Le présent appareil est conforme. Après examen de ce matériel aux normes de conformité ou aux limites d'intensité de champ RF, les utilisateurs peuvent sur l'exposition aux radiofréquences et la conformité et la conformité d'acquiescer les informations correspondantes.