

User Guide

Lenovo
LEGION

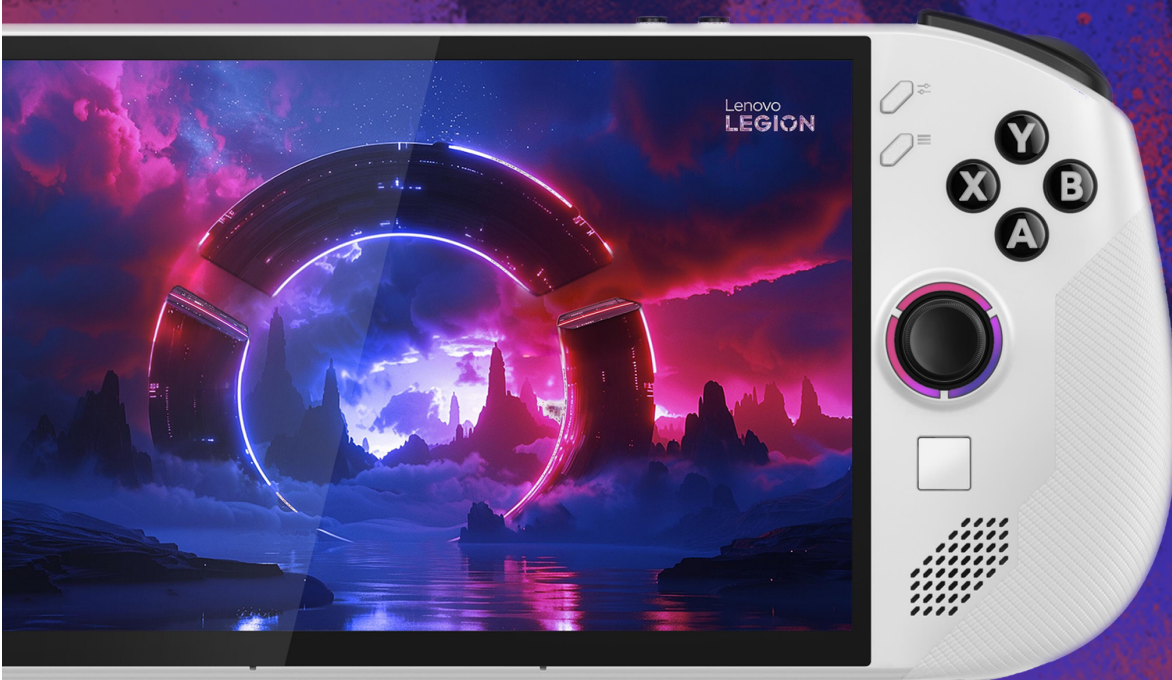

Lenovo

Lenovo Legion Go S (8", 1)

Read this first

Before using this documentation and the product it supports, ensure that you read and understand the following:

- [Generic Safety and Compliance Notices](#)
- *Safety and Warranty Guide*
- *Setup Guide*

Second Edition (June 2025)

© Copyright Lenovo 2024, 2025.

LIMITED AND RESTRICTED RIGHTS NOTICE: If data or software is delivered pursuant to a General Services Administration "GSA" contract, use, reproduction, or disclosure is subject to restrictions set forth in Contract No. GS-35F-05925.

Contents

About this guide iii

Chapter 1. Meet your Legion Go S . . . 1

Front view	1
Controls seen from the front view	2
Joystick light	2
Speakers	2
Antennas	2
Screen	2
Microphones	2
Ambient light sensor	2
Touchpad	2
Back view	3
LT and RT button range switch	3
Controls seen from the back view	4
Air vents (intake)	4
Top view	5
Controls seen from the top view	5
Air vents (outlet)	5
Multi-purpose USB Type-C connector	6
Charging light	6
Combo audio jack	6
Volume buttons	6
Power button	6
Power light	6
Bottom view	8
microSD card slot	8
Specifications	9
Statement on USB transfer rate	10
Using a Power Delivery compliant USB Type-C charger with the console.	11
Avoid constant body contact with specific hot sections	11
Operating environment	12

Chapter 2. Use your Legion Go S . . . 13

The Legion Space app	13
Thermal mode	13
Full speed fan	14
OS power mode	14
Adjustable screen resolution	14
Variable refresh rate	14
Controller vibration	15
Connect to an external display	15
Connect to a wired display.	15
Connect to a wireless display.	15
Change display settings.	15

Set the display mode	15
Preset shortcuts	16
Turbo key	16
Touch gestures	16
One-finger touch gestures	17
Two-finger touch gestures	17
Three- and four-finger touch gestures	18
Turn on night light	18
Adjust color temperature	19
Rechargeable battery pack	19
Rapid charge mode	19
Recover full battery capacity	19
A power plan	20
Change or customize a power plan	20

Chapter 3. Firmware setup utility . . . 21

Open the firmware setup utility	21
Use Windows advanced startup to open the firmware setup utility	21
Open the firmware setup utility from the Novo Button Menu	21
Update the firmware setup utility	21
Set passwords in UEFI/BIOS setup utility	21
Password types	22
Set administrator password	22
Change or remove administrator password	22
Set user password	23
Enable power-on password	23
Set password for the secondary storage device.	23
Change or remove hard disk password	24

Chapter 4. Help and support 25

Frequently asked questions	25
What should I do if the controller malfunctions?.	25
How to update the drivers and BIOS?	25
How to change the screen orientation?	25
How to adjust the dead zone of the joystick?	25
How to set the gyro?	25
Self-help resources	25
What is a CRU	26
CRUs for your product model	27
Call Lenovo	27
Before you contact Lenovo	27
Lenovo Customer Support Center	28
Purchase additional services.	28

Chapter 5. Console and accessibility 29

Accessibility features of the console hardware . . . 29

 USB connectors for connecting assistive technology devices 29

Accessibility features of Windows 11 29

 Configuring accessibility features in the Settings app 29

 Narrator 30

 Adjusting text sizes, applying a high-contrast theme, and using Magnifier 30

Accessible user documentation 31

 Accessibility features of user documentation 31

 Testing documentation accessibility 31

Appendix A. Notices and trademarks. 33

About this guide

- This guide applies to the Lenovo product model(s) listed below. Illustrations in this guide may look slightly different from your product model.

Table 1. Product model name and machine type

Model name	Machine type (MT)
<ul style="list-style-type: none">- Legion Go S 8ARP1- Lenovo Legion Go S 8ARP1 1	83L3
<ul style="list-style-type: none">- Legion Go S 8APU1- Lenovo Legion Go S 8APU1 1	83N6

Attention: This product is not intended for use by anyone under the age of 14.

- For further compliance information, refer to the *Generic Safety and Compliance Notices* at https://pcsupport.lenovo.com/docs/generic_notices.
- This guide may contain information about accessories, features, and software that are not available on all models.
- This guide contains instructions that are based on the Windows® operating system. These instructions are not applicable if you install and use other operating systems.
- Microsoft® makes periodic feature changes to the Windows operating system through Windows Update. As a result, the operating system instructions in this guide may become outdated. Refer to Microsoft resources for the latest information.
- The content of the guide is subject to change without notice. To obtain the latest version, go to <https://pcsupport.lenovo.com>.
- When you open <https://pcsupport.lenovo.com> or <https://support.lenovo.com>, change the country or region from the top bar.

Chapter 1. Meet your Legion Go S

Front view

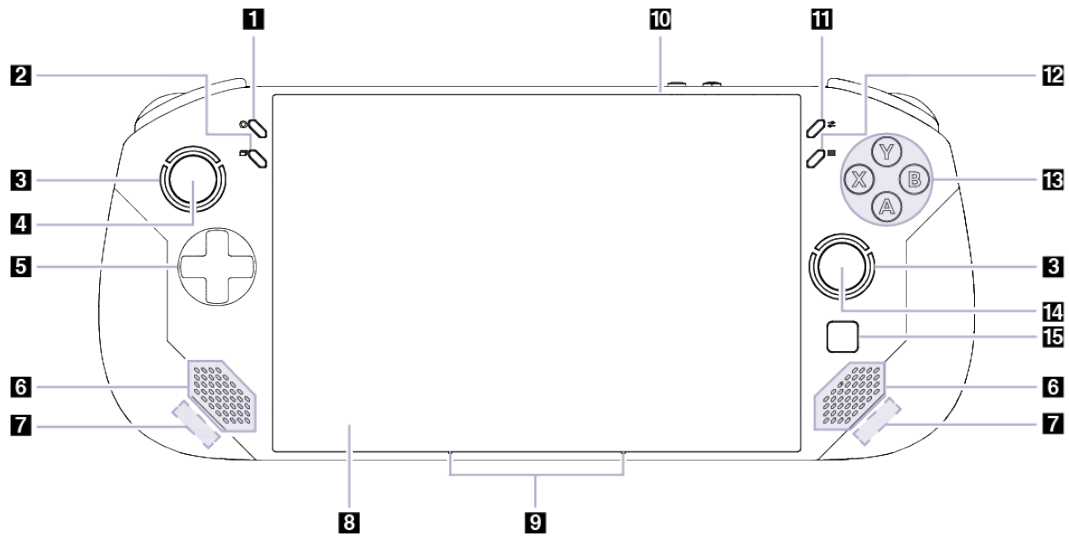

Figure 1. Front view of Legion Go S

Table 2. Components seen from the front view

No.	Description
1	Legion L
2	View button
3	Joystick light
4	Left joystick/LS
5	D-pad
6	Speakers
7	Antennas
8	Screen
9	Microphones
10	Ambient light sensor
11	Legion R
12	Menu button
13	ABXY buttons
14	Right joystick/RS
15	Touchpad

Controls seen from the front view

The View, Legion L, left joystick/LS, D-pad, Menu, Legion R, ABXY, and right joystick/RS controls are visible at the front of the console and perform different functions in different games. You can find their function descriptions in the controls guide of a specific Legion Go S game.

The left joystick and the right joystick are used to interact with games, apps, and the console interface. You can use a joystick to move an object on the screen in any direction. When you press down on a joystick, it can also function as a clickable button and it is then named LS/RS.

The D-pad is a directional pad that allows you to indicate four directions—up, down, left, and right.

Joystick light

The joystick light features RGB lighting and exudes a strong gaming style. When you turn the console on, you light up the joystick light around the left and right joysticks.

In the Legion Space app, you can tailor the color, brightness, and effect of the joystick light to your preferences.

Speakers

The speakers are built-in sound output devices.

Antennas

The antennas transmit and receive radio waves to allow data to be transferred between your console and a Wi-Fi network device or a Bluetooth device.

Note: The antennas are hidden inside the console.

Screen

The screen of the built-in display is where text, graphics, and videos are displayed.

The screen is touch-enabled, allowing you to interact with your console by intuitively touching buttons, icons, and menu items displayed on the screen. Touch-enabled screens also support multi-finger gestures.

Microphones

The microphones are built-in sound input devices. They capture your voice and ambient sound and convert them into digital form. Microphones are essential components when you use your console for video conferencing or voice recording.

Ambient light sensor

The ambient light sensor detects and measures the intensity of light in the user's environment. The data collected by this sensor can be used to enable adaptive brightness for the console's built-in display.

Touchpad

The touchpad is the console's built-in pointing device, which provides the basic functionality of an external mouse. Slide your finger on the touchpad to move the pointer on the screen and tap or double-tap to select or execute a screen item.

Back view

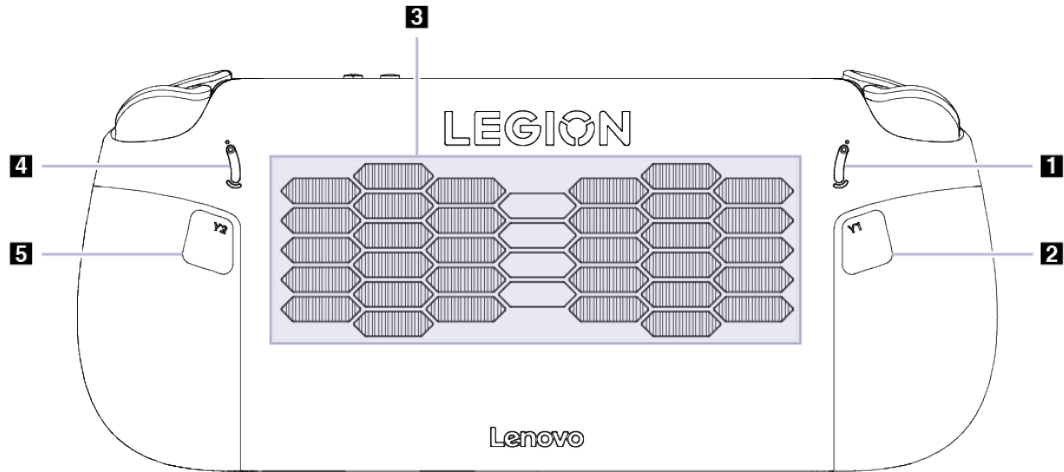

Figure 2. Back view of Legion Go S

Table 3. Components seen from the back view

No.	Description
1	LT button range switch
2	Y1 button
3	Air vents (intake)
4	RT button range switch
5	Y2 button

LT and RT button range switch

The switches are used to adjust the press range of the LT button and RT button.

After you toggle this switch to the top, the press range is short.

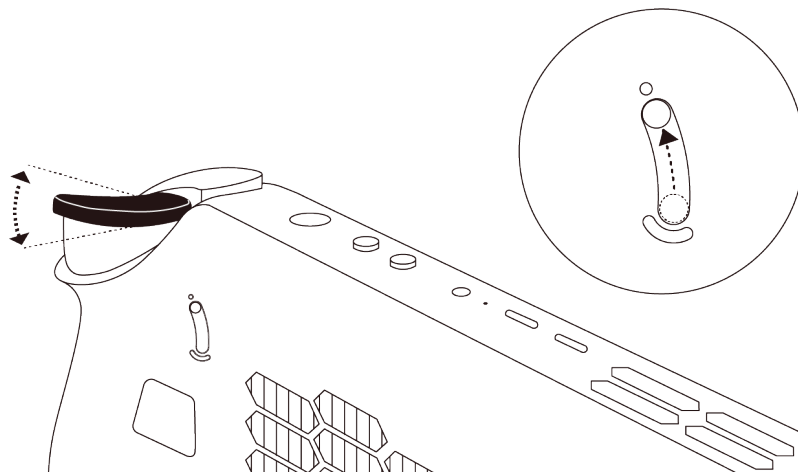

After you toggle this switch to the bottom, the press range is longer.

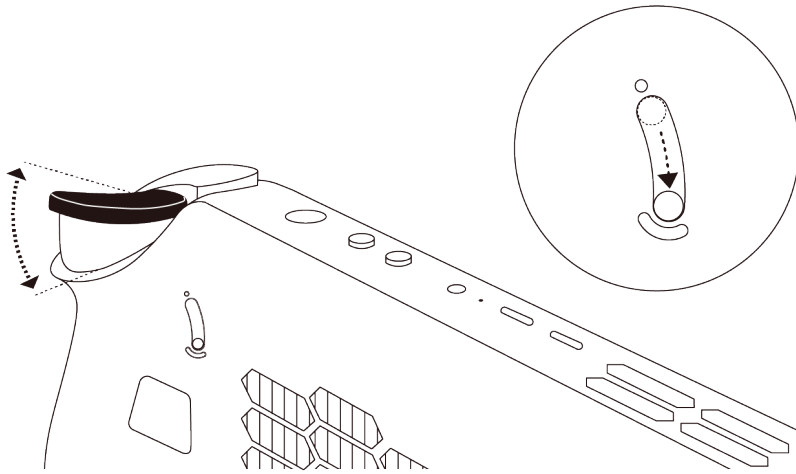

Controls seen from the back view

The Y1 and Y2 controls are visible at the back of the console and perform different functions in different games. You can find their function descriptions in the controls guide of a specific Legion Go S game.

Air vents (intake)

The air vents allow air to be sucked into the console to cool the internal components.

Important: When the console is operating, do not place it flat on a bed, sofa, carpet, or other flexible surfaces. Otherwise, the air vents will be blocked, and the console may overheat, reducing performance or causing the console to be unresponsive or even shut down.

Top view

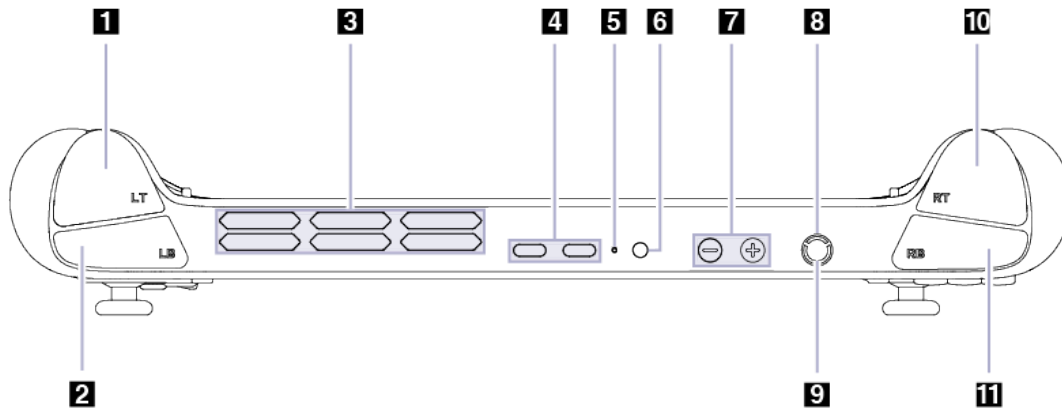

Figure 3. Top view of Legion Go S

Table 4. Components seen from the top view

No.	Description
1	LT button
2	LB button
3	Air vents (outlet)
4	Multi-purpose USB Type-C connector
5	Charging light
6	Combo audio jack
7	Volume buttons
8	Power button
9	Power light
10	RT button
11	RB button

Controls seen from the top view

The controls that can be seen from the top view, including the LT, LB, RT, and RB buttons perform different functions in different games. You can find their function descriptions in the controls guide of a specific Legion Go S game.

Air vents (outlet)

The air vents allow hot air to be discharged out of the console.

Important: When the console is operating, do not place it on a bed, sofa, carpet, or other flexible surfaces. Otherwise, the air vents will be blocked and the console may overheat, reducing performance or causing the console to be unresponsive or even shut down.

Multi-purpose USB Type-C connector

This USB Type-C® connector is the power input connector. Use the included power adapter and this connector to supply power to the console.

When this connector is not used by the included power adapter, it can also be used to connect:

- Storage or peripheral devices that follow the universal serial bus (USB) specification for data transfer and device interconnection
- Display devices

Note: When connecting display devices, you need to use appropriate cables and adapters (if needed) according to the connection capabilities of the display device.

Charging light

The charging light indicates whether the console is plugged into an electrical outlet. When the console is plugged into an electrical outlet, the color of the light indicates whether the battery is fully charged (or will shortly be fully charged).

Table 5. Charging light status and description

Light status	Plugged in?	Battery charge level
Off	No	/
On, amber	Yes	1%–90%
On, white	Yes	91%–100%

Combo audio jack

The combo audio jack is used to connect single-plug headsets, headphones, or external speakers.

Volume buttons

The volume buttons are built-in volume controls. Press  to turn the volume down and press  to turn it up.

Power button

Press the power button to turn on your console.

Note: By default, on a Windows product, pressing the power button when the product is turned on will put it into sleep mode.

Power light

The power light indicates the current power state of the console: whether it is powered on, powered off, in sleep mode, or in hibernation mode.

Table 6. Power light status and description

Light status	Power state
Solid on	Powered on
Blinking slowly	In sleep mode
Off	Powered off or in hibernation mode

The color of the power light can indicate the active thermal mode.

Table 7. Power light color and the console's active thermal mode

Light color	Thermal mode
White	Balance mode
Blue	Quiet mode
Red	Performance mode
Purple	Custom mode

Bottom view

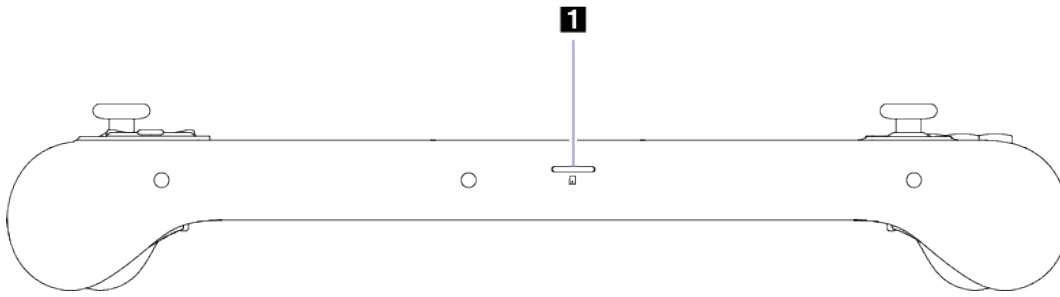

Figure 4. Bottom view of Legion Go S

Table 8. Components seen from the bottom view

No.	Description
1	microSD card slot

microSD card slot

The microSD card slot is used to insert a microSD, microSDHC, or microSDXC memory card to transfer data between the memory card and your console.

Specifications

Dimensions

Item	Value or specification
Length	299.0 mm
Width	127.55 mm
Thickness	22.6 mm

Display

Item	Value or specification
Type	LCD
Screen size (diagonal)	8 inches
Resolution	1920 × 1200
Supported refresh rates	<ul style="list-style-type: none">• 60 Hz• 120 Hz
Brightness	500 nits

Connectors and slots

Item	Value or specification
Combo audio jack	<ul style="list-style-type: none">• Diameter: 3.5 mm• Supported plug:<ul style="list-style-type: none">– 3-pole, TRS– 4-pole, TRRS (CTIA and OMTP)
microSD card reader	<ul style="list-style-type: none">• Quantity: 1• Interface: UHS-I
Multi-purpose USB Type-C connector	<ul style="list-style-type: none">• Quantity: 2• Maximum power output: 5 V, 3 A• Supported signaling protocols:<ul style="list-style-type: none">– USB 2.0 480 Mbps– SuperSpeed+ USB 10 Gbps– DisplayPort 1.4– USB4 40 Gbps

ac power adapter

Item	Value or specification
Input	100 V ac–240 V ac, 50 Hz–60 Hz
Output voltage	20 V

Item	Value or specification
Maximum output current	3.25 A
Maximum output power	65 W

Rechargeable battery pack

Item	Value or specification
Capacity	55.5 Wh
Cell type	Rechargeable Li-ion Battery
Number of cells	3

Note: The battery capacity is the typical or average capacity as measured in a specific test environment. Capacities measured in other environments may differ but are no lower than the rated capacity (see product label).

Memory

Item	Value or specification
Type	LPDDR5X
Installation	Onboard

Mass storage device

Item	Value or specification
Type	Solid-state drive (SSD)
Slot type	M.2 (2280)
Number of slots	1
Interface	PCIe Gen4

Networking

Item	Value or specification
Wi-Fi®	Wi-Fi 6E or Wi-Fi 6
Bluetooth®	Bluetooth 5.3

Note: Support of Bluetooth 5.3 may require a future operating system update.

Statement on USB transfer rate

Depending on many factors such as the processing capability of the host and peripheral devices, file attributes, and other factors related to system configuration and operating environments, the actual transfer rate using the various USB connectors on this device will vary and will be slower than the data rate listed below for each corresponding device.

Table 9. USB device and the corresponding data rate

USB device	Data rate (Gbit/s)
USB 3.2 Gen 1	5
USB 3.2 Gen 2	10
USB4	40

Using a Power Delivery compliant USB Type-C charger with the console

Lenovo branded USB Type-C chargers with the following listed maximum rating are tested to work with the console. Chargers of other brands with the same ratings should also work but are not thoroughly tested.

- 20 V, 3.25 A

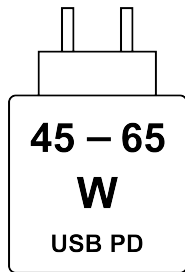

USB PD fast charging: The power delivered by the charger must be between min 45 Watts required by the radio equipment and max 65 Watts, in order to achieve the maximum charging speed.

CAUTION:

When purchasing third-party USB Type-C chargers for use with the computer, choose a product that is safety approved or certified. A disqualified charger may cause damage to your computer or pose an electrical hazard.

In many countries and regions, manufacturers or importers of electric chargers can submit their products to a certification authority or approved and recognized testing laboratories. Such a product usually carries a mark if it was tested to pass relevant quality and safety standards. For some countries and regions, this certification process is even mandatory.

If you live in mainland China, choose a charger with the “CCC” mark; for users in many European countries, choose one with the “CE” mark; for users in the United States and Canada, choose a Listed charger that carries a mark by one of the Nationally Recognized Testing Laboratories. (For example, the “UL Listed” mark). For people living in other countries and regions, consult a qualified electrical engineer for how to select a safety approved electric charger.

Avoid constant body contact with specific hot sections

CAUTION:

When the console is operating, it should be placed on a hard and flat surface with its back area not in contact with the user’s bare skin. Under normal operating conditions, the temperature of the back surface will remain within an acceptable range as defined in IEC 62368-1, but such temperatures can still be high enough to cause discomfort or harm to the user if directly touched for over 10 seconds at a time. As such, it is recommended that users avoid prolonged direct contact with the back of the console.

Operating environment

Maximum altitude (without pressurization)

3048 m (10 000 ft)

Temperature

- At altitudes up to 2438 m (8000 ft)
 - Operating: 5°C to 35°C (41°F to 95°F)
 - Storage: 5°C to 43°C (41°F to 109°F)
- At altitudes above 2438 m (8000 ft)
 - Maximum temperature when operating under the unpressurized condition: 31.3°C (88°F)

Note: When you charge the battery, its temperature should be no lower than 10°C (50°F).

Relative humidity

- Operating: 8% to 95% at wet-bulb temperature 23°C (73°F)
- Storage: 5% to 95% at wet-bulb temperature 27°C (81°F)

Chapter 2. Use your Legion Go S

The Legion Space app

Legion Space is an app developed specifically to help you manage game resources, control hardware settings, and check the status of the device.

To access the app, type `Legion Space` in the Windows search box. You can also find the app from the taskbar.

In this app, you can:

- Manage local games.
- Adjust performance settings by switching between different thermal modes, power modes, or fan speeds.
- Set the display brightness, resolution, or refresh rate.

Note: Periodic updates to the Legion Space app may be available through online updates. Features may be added or modified after updates are installed.

Thermal mode

Several thermal modes are preset in the console. The maximum attainable performance, power consumption, and speed limit for the heat sink fan vary between different thermal modes.

You can switch between thermal modes in the **Performance** section of the Legion Space app, or by pressing the button combination of Legion L + Y.

The following table lists the available thermal modes on your console and the recommended conditions for each mode.

Table 10. Thermal modes and their recommended usage conditions

Thermal mode	Recommended conditions
30 W (Performance mode)	<ul style="list-style-type: none">• Your console is plugged into an electrical outlet.• You want the best performance.• You don't care if the fan makes a little noise.
15 W (Balance mode)	<ul style="list-style-type: none">• Your console is operating on battery power.• You plan to frequently switch between different tasks over a period of time.
10 W (Quiet mode)	<ul style="list-style-type: none">• You want to save battery power.• You want the console to be as quiet as possible.
5–40 W (Custom mode)	You want to customize the Thermal Design Power based on your usage scenario.

Note: In the Legion Space app, you can drag the scroll button to select a value within the range of 5–40 W. When you switch the console to Custom mode, the Thermal Design Power is adjusted to the selected value.

Full speed fan

The system fan can help the CPU dissipate the heat so that it can work for a long time without malfunctioning. To dissipate the heat more quickly, Full speed fan mode is preset in the Legion Space app.

Generally, the system fan provides sufficient cooling when you use your device for work and study. When you begin to play a demanding game, you may want the console to cool down rapidly. In this case, you can enable Full speed fan mode in the **Performance** section of the Legion Space app.

Note: The faster the fan spins, the more heat can be dissipated. However, a faster fan speed also leads to excessive power consumption and shortens its life cycle.

OS power mode

You can switch between power modes based on your power usage and performance needs to optimize your console experience.

Go to **Settings → System → Power & battery** to switch between power modes. You can also switch modes in the **Performance** section of the Legion Space app.

The following table lists the available power modes on your console and the recommended conditions for each mode.

Table 11. Power modes and their recommended usage conditions

Power mode	Recommended conditions
Best performance	<ul style="list-style-type: none">Your console is plugged into an electrical outlet.You want the best performance.
Balanced	You want to find a balance between power use and performance.
Best power efficiency	<ul style="list-style-type: none">Your console is operating on battery power.You want the console to save power.

Note: This feature is not available when energy saver is on.

Adjustable screen resolution

A screen uses millions of pixels to display images. The number of pixels in the horizontal and vertical directions is shown as the screen resolution. A higher resolution indicates more pixels, which generally means better image quality and more details.

You can manually switch the screen resolution. The settings can be found in **Settings → System → Display**. You can also switch the resolution in the **Display** section of the Legion Space app.

Variable refresh rate

Your eyes might not notice it but the content displayed on the screen refreshes constantly. The display refresh rate refers to the number of times per second the screen content refreshes itself and is measured in hertz (Hz).

A refresh rate of 60 Hz is adequate for most situations and is energy efficient. However, when viewing videos or playing video games, a higher refresh rate usually provides a smoother viewing experience.

The display of your device supports dual refresh rates. You can manually switch the display to work at either a higher or lower refresh rate. The settings can be found in **Settings → System → Display → Advanced display**. You can also switch the refresh rate in the **Display** section of the Legion Space app.

Controller vibration

When you are playing games, the built-in motor of the controller vibrates to simulate some gaming effects such as impacts and strikes.

Four vibration levels are preset in the built-in controller—off, low, medium, and strong. The motor is set to the medium level by default, and you can switch the motor to other levels by pressing the button combination of **Legion L** and **D-pad Up/Down key**.

When you toggle between different levels, the built-in controller vibrates for two seconds to indicate that the switch is successful.

Connect to an external display

Connect to a wired display

Connect your console to the desired display with an appropriate cable.

Step 1. Connect one end of the display cable to a multi-purpose USB Type-C connector on your console.

Step 2. Connect the other end of the cable to the display.

Connect to a wireless display

Ensure that:

- Both your console and the display support Miracast® technology.
- The display is connected to the same Wi-Fi network as your console and is discoverable.

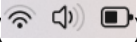
Step 1. Open the quick settings menu by selecting the network, sound, or battery icons () on the far right of the taskbar.

Step 2. Select the **Cast** button.
The computer searches for wireless display devices and audio devices and lists the results.

Step 3. Select the display you want to connect to, and then follow the on-screen instructions.

Change display settings

Step 1. Long press on a blank area on the desktop, and then select **Display settings**.
Your console shows the **Display** window.

Step 2. Select the display for which you want to change the settings.

Step 3. Change the display settings as necessary.

Set the display mode

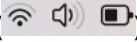
Step 1. Open the quick settings menu by selecting the network, sound, or battery icons () on the far right of the taskbar.

Step 2. Select the **Project** button.
Your computer shows a list of display modes, with the current mode highlighted.

Step 3. Select a display mode from the list.

Preset shortcuts

The shortcuts preset in the console provide quick access to frequently used settings, tasks, and apps.

Table 12. Shortcuts in Legion Go S

Shortcut	Action
Legion L.	Starts the Legion Space app.
Legion R.	Opens or closes the sidebar.
Legion L + Y.	Switches between thermal modes.
Legion L + X.	Opens the Windows snipping tool.
Legion L + A.	Simulates the function of Ctrl + Alt + Del to start Windows Security.
Legion L + B.	Opens the virtual keyboard.
Legion L + LB.	Opens the list of preset shortcuts.
Legion L + RB.	Switches between X-input mode and D-input mode.

Turbo key

A turbo key is a powerful tool that allows you to automate repetitive tasks by recording a series of keystrokes, which can save a lot of time and effort if you need to perform the same tasks frequently.

To program a turbo key, you press and hold the Y1 button for 3 seconds, press a sequence of buttons using the A/B/X/Y/LB/RB/LT/RT, and then press the Y1 button. The next time you press the programmed Y1 button, the defined keystrokes are repeated automatically. You can also program it for the Y2 button.

To toggle the turbo key frequency, press the D-pad left or right button when pressing the programmed turbo key. The joystick light blinks once to indicate the turbo key is toggled to 2 Hz, twice to indicate the key is toggled to 5 Hz, and three times to indicate the key is toggled to 8 Hz.

To clear the turbo key setting, press and hold the programmed turbo key for 7 seconds.

Notes:

- Whether your console comes with this feature preloaded depends on the actual situation.
- If your console does not support this feature, you can check the latest version of the Legion Space app and install updates.

Touch gestures

You can touch the screen with your fingers to interact with the console. The following sections introduce frequently used touch gestures.

Notes:

- Some gestures might not be available when you are using certain apps.
- Do not use gloved fingers or incompatible digital pens on the screen. Otherwise, the touch screen might not be sensitive or even does not respond.

- The touch screen is delicate. Do not apply pressure on the screen or touch the screen with anything hard or sharp. Otherwise, the touch panel might malfunction or get damaged.

One-finger touch gestures

Table 13. One-finger touch gestures and the corresponding actions

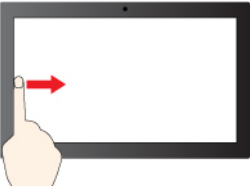
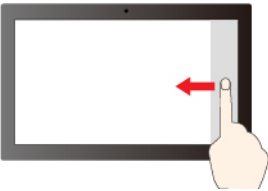
Action	Gesture
Open a shortcut menu.	Press and hold. 
See widgets.	Swipe from the left. 
Open the notification center.	Swipe from the right. 

Two-finger touch gestures

Table 14. Two-finger touch gestures and the corresponding actions

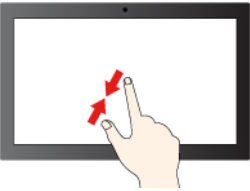
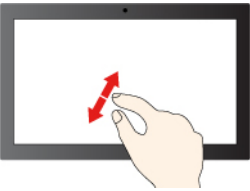
Action	Gesture
Zoom out.	Place two fingers on the screen and pinch in. 
Zoom in.	Place two fingers on the screen and stretch out. 

Three- and four-finger touch gestures

Table 15. Three- and four-finger touch gestures and the corresponding actions

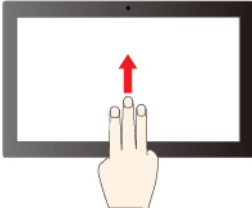
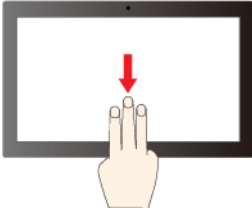
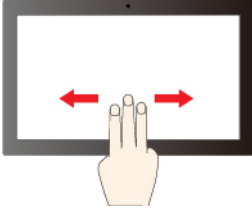
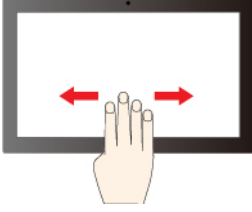
Action	Gesture
Show all open windows.	Swipe with three fingers up. 
Show the desktop.	Swipe with three fingers down. 
Switch apps.	Swipe with three fingers to the left or right. 
Switch desktops.	Swipe with four fingers to the left or right. 

Enable three- and four-finger touch gestures

Step 1. Type touch gesture in the Windows search box and then press Enter.

Step 2. Turn on the **Three- and four-finger touch gestures** switch.

Turn on night light

The night light feature enables users to switch to warmer color tones, reducing blue light emission to alleviate eye strain or fatigue.

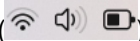
Step 1. Open the quick settings menu by selecting the network, sound, or battery icons () on the far right of the taskbar.

Step 2. Select the button for night light to turn it on or off.

Note: Some Windows 11 versions allow users to customize their quick settings. If the night light button is not visible, you can add it to the quick settings menu by selecting the edit button (✎).

For more tips on reducing eye strain or fatigue, visit <https://www.lenovo.com/us/en/compliance/visual-fatigue>.

Adjust color temperature

If the night light mode is turned on, you can adjust the color temperature of the screen.

Step 1. Select **Start** → **Settings**.

Step 2. Select **System** → **Display** → **Night light**.

Step 3. Move the slider to adjust the color temperature.

Note: Selected Lenovo products are low blue-light certified. These products undergo testing with the night light turned on and the color temperature value set at 48 or above.

Rechargeable battery pack

Your console includes a built-in, rechargeable battery pack that makes mobile computing a reality.

When the console is plugged into an electrical outlet, the battery charges. If you use the console when you don't have access to an electrical outlet, the battery discharges to supply the electricity that the console system requires for operation.

Battery charging is affected by its temperature. The recommended temperature range for charging the battery is between 10°C (50°F) and 35°C (95°F).

Note: To maximize the life of the battery, once the battery is fully charged, it must discharge to 94% or lower before it is allowed to recharge again.

Rapid charge mode

The battery of the console is in rapid charge mode by default. The following table lists the estimated time needed for batteries in rapid charge mode to be charged to 80% and 100% respectively.

Table 16. Estimated charge time for batteries in rapid charge mode

Mode	Time needed to charge from 0% to 80%	Time needed to charge from 0% to 100%
Rapid charge	Less than 1 hour	Less than 2 hours

Note: The estimated charge time assumes that the battery is charged when the console is in sleep, hibernation, or powered-off state.

Recover full battery capacity

If your console is constantly plugged in to an electrical outlet and the battery rarely discharges, the battery may not be charged to its full capacity even if the battery meter reports 100% charge. You can recover the battery's full charging potential simply by discharging and re-charging the battery.

Step 1. Unplug the console and use it until the battery charge drops below 20%.

Step 2. Plug in the console and charge the battery to 100%.

A power plan

A power plan is a collection of power-saving settings made available by an operating system. With a power plan, you can set idle time-outs for different hardware components to enter a low-power state. The default power plan and some of its idle time-out settings are listed below.

The listed settings are active when the console is connected to an electrical outlet. If your console includes a built-in battery pack, a different collection of time-out settings is set to take effect when the console is operating on battery power.

Table 17. Default power-saving settings

Power plan	Balanced
Turn off the display	After 5 minutes
Put the computer to sleep	After 5 minutes

Change or customize a power plan

You can customize the power-saving settings for the default power plan according to your usage of the console.

- Step 1. Type power plan in the Windows search box and select **Choose a power plan** in the matched results.
- Step 2. Select **Change plan settings** and change the time-out settings for turning off the display and putting the computer to sleep.

Note: If you want to change other time-out settings, select **Change advanced power settings**.

- Step 3. After changes are made, select **Save changes**.

Chapter 3. Firmware setup utility

Your console includes a flash ROM (read-only memory) chip on the system board. It contains code to start up the console. The ROM chip and the stored code are referred to as the console's firmware. Firmware plays a key role in the operation of the console. When you turn on the console, the firmware checks and initiates the console's hardware devices. It also checks the boot device for completeness and security, before executing the code to start up the operating system.

Open the firmware setup utility

A Lenovo console usually provides a setup utility that allows you to change some firmware settings. You can use Windows advanced startup or the Novo Button Menu to open the firmware setup utility.

Use Windows advanced startup to open the firmware setup utility

From Windows operating system, you can use advanced startup to restart your console and open the firmware setup utility.

- Step 1. Select **Settings** → **System** → **Recovery**.
- Step 2. Under **Advanced startup**, select **Restart now**.
- Step 3. Select **Troubleshoot** on the **Choose an option** page.
- Step 4. Select **Advanced options** on the **Troubleshoot** page.
- Step 5. Select **UEFI Firmware Settings** on the **Advanced options** page.
- Step 6. Click **Restart**.

Your console will restart to open the firmware setup utility.

Open the firmware setup utility from the Novo Button Menu

The console provides a shortcut to open the firmware setup utility.

Make sure your console is powered off.

- Step 1. While holding down , press the power button until the **Novo Button Menu** is displayed.
- Step 2. Select **BIOS Setup** from the Menu.

Update the firmware setup utility

You can check the BIOS update from the **Disks and Drivers** section in the Legion Space app. Before the update, you must connect your console to the power supply.

Note: Your screen may go black for almost two minutes during the update, do not unplug the charger or power off your device.

Set passwords in UEFI/BIOS setup utility

This section introduces the types of passwords that you can set in the UEFI (Unified Extensible Firmware Interface) or BIOS (Basic Input/Output System) setup utility.

Password types

You can set various types of passwords in the UEFI/BIOS setup utility.

Table 18. Pre-requisites and usages of different password types

Password type	Pre-requisite	Usage
Administrator password	No	You must enter it to start the setup utility.
User password	The administrator password must be set.	You can use the user password to start the setup utility.
Master hard disk password	No	You must enter it to start the operating system.
User hard disk password	The master hard disk password must be set.	You can use the user hard disk password to start the operating system.

Notes:

- All passwords set in the setup utility consist of alphanumeric characters only.
- If you start the setup utility using the user password, you can only change a few settings.

Set administrator password

You set the administrator password to prevent unauthorized access to the UEFI/BIOS setup utility.

Attention: If you forget the administrator password, a Lenovo authorized service personnel cannot reset your password. You must take your console to a Lenovo authorized service personnel to have the system board replaced. Proof of purchase is required and a fee will be charged for parts and service.

- Step 1. Open the UEFI/BIOS setup utility.
- Step 2. Select **Security** → **Set Administrator Password** and press Enter.
- Step 3. Enter a password string that contains only letters and numbers and then press Enter.
- Step 4. Enter the password again and press Enter.
- Step 5. Select **Exit** → **Exit Saving Changes**.

Next time you start the console, you must enter the administrator password to open the setup utility. If **Power on Password** is enabled, you must enter the administrator password or the user password to start the console.

Change or remove administrator password

Only the administrator can change or remove the administrator password.

- Step 1. Open the UEFI/BIOS setup utility using the administrator password.
- Step 2. Select **Security** → **Set Administrator Password** and press Enter.
- Step 3. Enter the current password.
- Step 4. In the **Enter New Password** text box, enter the new password.
- Step 5. In the **Confirm New Password** text box, enter the new password again.

Note: If you want to remove the password, press Enter in both text boxes without entering any character.

Step 6. Select **Exit → Exit Saving Changes**.

If you remove the administrator password, the user password is also removed.

Set user password

You must set the administrator password before you can set the user password.

The administrator of the setup utility might need to set a user password for use by others.

Step 1. Open the UEFI/BIOS setup utility using the administrator password.

Step 2. Select **Security → Set User Password** and press Enter.

Step 3. Enter a password string that contains only letters and numbers and then press Enter.
The user password must be different from the administrator password.

Step 4. Enter the password again and press Enter.

Step 5. Select **Exit → Exit Saving Changes**.

Enable power-on password

If the administrator password has been set, you can enable power-on password to enforce greater security.

Step 1. Open the UEFI/BIOS setup utility.

Step 2. Select **Security → Power on Password** and press Enter.

Note: The administrator password must be set in advance.

Step 3. Change the setting to **Enabled**.

Step 4. Select **Exit → Exit Saving Changes**.

If power-on password is enabled, a prompt appears on the screen every time you turn on the device. You must enter the administrator or user password to start the device.

Set password for the secondary storage device

Permanent data is stored on secondary storage devices. Your console may include one or more solid-state drive or hard disk drive as secondary storage device(s). You can set passwords for secondary storage devices in the setup utility to prevent unauthorized access to your data.

Attention: Be extremely careful when setting a hard disk password. If you forget the hard disk password, a Lenovo authorized service personnel cannot reset your password or recover data from the hard disk. You must take your console to a Lenovo authorized service personnel to have the hard disk drive replaced. Proof of purchase is required and a fee will be charged for parts and service.

Step 1. Open the UEFI/BIOS setup utility.

Step 2. Select **Security → Set Hard Disk Password** and press Enter.

Note: If your console includes more than one secondary storage device, you can set separate passwords for each device. If you start the setup utility using the user password, you cannot set hard disk password.

Step 3. Follow on-screen instructions to set both master and user passwords.

Note: The master and user hard disk passwords must be set at the same time.

Step 4. Select **Exit → Exit Saving Changes**.

If the hard disk password is set, you must provide the correct password to start the operating system.

Change or remove hard disk password

- Step 1. Open the UEFI/BIOS setup utility.
- Step 2. Select **Security**.
- Step 3. Change or remove the hard disk password.

To change or remove master password, select **Change Master Password of Hard Disk** and press Enter.

Note: If you remove the master hard disk password, the user hard disk password is also removed.

To change user password, select **Change User Password of Hard Disk** and press Enter.

Note: The user hard disk password cannot be removed separately.

- Step 4. Select **Exit → Exit Saving Changes**.

Chapter 4. Help and support

Frequently asked questions

What should I do if the controller malfunctions?

You can try resetting the controller to factory settings. Press and hold Legion L + LB + Menu button for 4 seconds to reset the controller to factory settings.

Note: The data stored in the controller will be deleted after resetting the controller.

How to update the drivers and BIOS?

- Step 1. Open the Legion Space app and select the **SETTINGS** tab.
- Step 2. Select **Disks and Drivers** and then Click **Check for Updates**.
- Step 3. According to the check results, download and install the new versions of the drivers and BIOS.

How to change the screen orientation?

- Step 1. Click the Start menu on the taskbar and then select **Settings**.
- Step 2. Select **System** and then select **Display**.
- Step 3. Select **Portrait** from the drop-down list next to **Display orientation**.

Note: If **Display orientation** is disabled, you should turn on the **Rotation lock** first.

How to adjust the dead zone of the joystick?

The dead zone is where you can move your joystick before the input is registered. The larger the dead zone, the more effort is required to register inputs. However, if the dead zone is too small, the controller may become too sensitive, even causing false inputs when the joystick is untouched.

- Step 1. Open the Legion Space app and then select the **CONTROLLERS** tab.
- Step 2. Select **Joystick Settings** and then slide to adjust the dead zone of the left joystick and right joystick.

Note: You can adjust the dead zone from 1% to 100%. When the value is lower than 5%, the joystick may have a drift issue.

How to set the gyro?

A gyro is a device that measures and maintains the rotational motion. It is built in the controller to help control the game's objects and provide feedback to you.

- Step 1. Open the Legion Space app and then select the **CONTROLLERS** tab.
- Step 2. Select **Gyro Settings** and then select one gyro behavior for the controller.

Self-help resources

Use the following self-help resources to learn more about the console and troubleshoot problems.

Table 19. Access to self-help resources

Resources	How to access?
Troubleshooting and frequently asked questions	<ul style="list-style-type: none"> • https://www.lenovo.com/tips • https://forums.lenovo.com
Accessibility information	https://www.lenovo.com/accessibility
Reset or restore Windows	<ol style="list-style-type: none"> 1. Go to https://pcsupport.lenovo.com. 2. Find the information about system recovery from the Troubleshooting section and follow the on-screen instructions.
Product documentation: <ul style="list-style-type: none"> • Generic Safety and Compliance Notices • Safety and Warranty Guide • Setup Guide • This User Guide • Regulatory Notice 	<ol style="list-style-type: none"> 1. Go to https://pcsupport.lenovo.com. 2. Detect your product or manually select your product model. 3. Filter out the documentation you want.
Latest support information: <ul style="list-style-type: none"> • Drivers and software • Diagnostic solutions • Product and service warranty • Product and parts details • Knowledge base 	https://support.lenovo.com
Windows help information	<ul style="list-style-type: none"> • Search Get Help or Tips in the Windows search box. • Use Windows Search or the Cortana® personal assistant. • Microsoft support Web site: https://support.microsoft.com

Note: When you open <https://pcsupport.lenovo.com> or <https://support.lenovo.com>, change the country or region from the top bar.

What is a CRU

Customer replaceable units (CRUs) are parts that can be upgraded or replaced by the customer. A Lenovo product may contain the following types of CRUs:

Self-service CRU

Parts that can be installed or replaced easily by customers themselves or by trained service technicians at an additional cost.

Optional-service CRU

Parts that can be installed or replaced by customers with a greater skill level. Trained service technicians can also provide service to install or replace the parts under the type of warranty designated for the customer's machine.

If you intend to install a CRU, Lenovo will ship the CRU to you. You might be required to return the defective part that is replaced by the CRU. When a return is required: (1) return instructions, a prepaid shipping label,

and a container will be included with the replacement CRU; and (2) you might be charged for the replacement CRU if Lenovo does not receive the defective CRU within thirty (30) days of your receipt of the replacement CRU. For full details, see the *Lenovo Limited Warranty* at https://www.lenovo.com/warranty/llw_02.

CRUs for your product model

The table below lists the CRUs and CRU types that are defined for your product model.

Table 20. CRUs for Legion Go S

Part	Self-service CRU	Optional-service CRU
ac power adapter *	X	
Power cord *	X	
Joystick Caps		X

Notes:

- CRU replacement instruction is provided in one or more of the following publications and is available from Lenovo at any time upon your request.
 - the product *User Guide*
 - the printed publications that came with the product
- Replacement of any parts not listed above, including the built-in rechargeable battery, should be done by a qualified repair technician or by ensuring that you carefully follow all instructions provided by Lenovo. You can also find Lenovo-authorized repair facilities by going to <https://support.lenovo.com/partnerlocator> for more information.
- Parts labeled with an asterisk (“*”) are available on selected product models.

Call Lenovo

If you have tried to correct the problem yourself and still need help, you can call Lenovo Customer Support Center.

Before you contact Lenovo

Record product information and problem details before you contact Lenovo.

The following product information should be recorded.

- Product name
- Machine type and serial number

The problem symptoms and details should be recorded.

- What is the problem? Is it continuous or intermittent?
- Any error message or error code?
- What operating system are you using? Which version?
- Which software applications were running at the time of the problem?
- Can the problem be reproduced? If so, how?

Note: The product name and serial number can usually be found on the back of the product, either printed on a label or etched on the cover.

Lenovo Customer Support Center

During the warranty period, you can call Lenovo Customer Support Center for help.

Telephone numbers

For a list of the Lenovo Support phone numbers for your country or region, go to <https://pcsupport.lenovo.com/supportphonenumberlist>.

Note: Phone numbers are subject to change without notice. If the number for your country or region is not provided, contact your Lenovo reseller or Lenovo marketing representative.

Services available during the warranty period

- Problem determination - Trained personnel are available to assist you with determining if you have a hardware problem and deciding what action is necessary to fix the problem.
- Lenovo hardware repair - If the problem is determined to be caused by Lenovo hardware under warranty, trained service personnel are available to provide the applicable level of service.
- Engineering change management - Occasionally, there might be changes that are required after a product has been sold. Lenovo or your reseller, if authorized by Lenovo, will make selected Engineering Changes (ECs) that apply to your hardware available.

Services not covered

- Replacement or use of parts not manufactured for or by Lenovo or nonwarranted parts
- Identification of software problem sources
- Configuration of UEFI/BIOS as part of an installation or upgrade
- Changes, modifications, or upgrades to device drivers
- Installation and maintenance of network operating systems (NOS)
- Installation and maintenance of programs

For the terms and conditions of the Lenovo Limited Warranty that apply to your Lenovo hardware product, see “Warranty information” in the *Safety and Warranty Guide* that comes with your product.

Purchase additional services

During and after the warranty period, you can purchase additional services from Lenovo at <https://pcsupport.lenovo.com/warrantyupgrade>.

Service availability and service name might vary by country or region.

Chapter 5. Console and accessibility

To meet the vision of delivering Smarter Technology for All, Lenovo designs with all users in mind. This chapter explores the accessibility features available on your Lenovo console, including both hardware components and those offered by the pre-installed operating system. By gaining a comprehensive understanding of the available accessibility features and how to activate and configure them, you can enhance your console's usability.

Accessibility features of the console hardware

Lenovo consoles are designed with accessibility in mind. Throughout the design process, special considerations are prioritized for individuals with disabilities and best industry practices are implemented in hardware design.

USB connectors for connecting assistive technology devices

Several types of assistive technology devices are available on the market that can be connected to a console to enhance its accessibility. For example, a refreshable Braille display is an assistive technology device that enables individuals who are blind or deafblind to use a console. When connected to a console, a refreshable Braille display can work in conjunction with a compatible screen reader to provide tactile output in Braille characters. Blind or deafblind individuals who have been trained to read Braille can run their fingers over the display to comprehend the information presented on the console.

Many assistive technology devices utilize USB technology for connectivity. Lenovo consoles are equipped with at least one USB connector that adheres to the relevant USB specifications and is backward compatible. If the plug type of the assistive technology device does not match the USB connector on your console, you can easily purchase and use a USB adapter to resolve the issue.

Accessibility features of Windows 11

An operating system is a crucial piece of software installed on a console. It plays a vital role in the console's basic functionality by providing a user interface, various tools for system management, and a foundation upon which additional specialized applications can be installed.

Microsoft's Windows 11 is a modern operating system that comes pre-installed on Lenovo consoles. It offers a rich set of accessibility features designed for individuals with diverse disabilities. This section outlines the accessibility features available in Windows 11, explains how to activate them, and discusses the benefits they provide.

Notes: The following accessibility features of Windows have been tested and confirmed to deliver their essential functionalities on Lenovo consoles that come pre-installed with Windows 11.

- Narrator
- Magnifier

Configuring accessibility features in the Settings app

Windows 11 provides a centralized location within the Settings app for activating and configuring all accessibility features. You can access this section by selecting **Start → Settings → Accessibility**.

Narrator

Narrator is Windows 11's built-in screen-reading application. It can read screen content aloud to users, enabling individuals with visual impairments to navigate effectively within Windows 11, use applications, and browse the web.

Start and stop Narrator

You can start and stop Narrator by selecting the toggle button for Narrator in the centralized Accessibility section of the Settings app.

Customize Narrator

Narrator offers a variety of controls that allow you to customize it to suit your preferences. For example, you can install additional text-to-speech voices and select your preferred voice for Narrator. You also have the option to adjust the verbosity level to choose the type of content to be read. All Narrator settings are conveniently located in the centralized Accessibility section of the Settings app.

Adjusting text sizes, applying a high-contrast theme, and using Magnifier

For individuals who find it difficult to see text clearly on the screen, Windows offers the options of adjusting text sizes, applying a high-contrast theme, and using Magnifier.

Adjust text sizes

If you find the text on the screen is too small to read, you can scale up the size of text displayed by Windows and other applications.

Step 1. Select **Start → Settings → Accessibility → Text size**.

Step 2. Use the slider and the preview pane to select a size that fits your need and then select **Apply**.

Apply a high-contrast theme

For individuals with low vision, Windows 11 offers contrast themes that enhance text readability by using a background color that sharply contrasts with the text.

Step 1. Select **Start → Settings → Accessibility → Contrast themes**.

Step 2. In the dropdown list for **Contrast themes**, select one option and then select **Apply**.

To exit a contrast theme, select **None** from the dropdown list.

Enable Magnifier

You can enable Windows 11 Magnifier to enlarge specific areas or the entire screen, making text and images easier to see.

Step 1. Select **Start → Settings → Accessibility → Magnifier**.

Step 2. Select the toggle to enable or disable Magnifier.

- To zoom in and out, tap the plus(+) and minus(-) symbols on the corners of the screen.
- To move around the screen, tap on the borders.
- To see where you are on the screen, tap with one finger on opposite borders of the screen simultaneously.
- To close Magnifier, tap the minus(-) symbol to zoom out, then tap the Close(X) button.

Accessible user documentation

Documentation containing instructions for the use of the product, including its accessibility features, is available in accessible formats (such as HTML and PDF) on the Lenovo Support Website. When creating documentation, a series of industry standards and best practices are followed to ensure that the content is useful to as broad an audience as possible. Additionally, automated testing tools are employed to identify issues that may hinder the accessibility of information. These issues are addressed to the extent permitted by commonly available technologies.

Accessibility features of user documentation

By adhering to industry standards and best practices, Lenovo documentation offers numerous features that facilitate the perception and understanding of the content. Additionally, several of these features are specifically designed to ensure that users of assistive technology devices can access information comparable to that available to those who do not rely on such devices.

Perceivable content

Text content is presented using popular and easy-to-read fonts. Text colors are in high contrast with the background. Non-text elements, such as graphics and videos that convey important information, are accompanied by alternative text descriptions. Users with visual impairments can utilize screen readers to access information comparable to that available to sighted users.

Understandable content

The documentation is presented visually in a well-structured and simple layout. It also includes hidden tags or other markup information that store the content's structure, which can be utilized programmatically by assistive technologies to convey this structure to users.

Operable content

Documentation includes industry-standard tags for sectioning and interactive elements, such as titles, headings, various structural components, links, buttons, and input fields. Screen reader users can utilize standard modifier keys on a keyboard to effectively navigate and interact with the documentation.

Testing documentation accessibility

Before being officially released, Lenovo documentation undergoes testing with automated tools to evaluate its accessibility. HTML documents are assessed for compliance with the success criteria outlined in the *Web Content Accessibility Guidelines (WCAG)*, a widely accepted set of standards designed to enhance web document accessibility. PDF documents are evaluated for accessibility using the accessibility checker in Adobe Acrobat for the same purpose. Automated testing tools help identify elements within a document that may present challenges when rendered by screen readers and other assistive technology devices. Accessibility issues identified by these automated tools are subsequently analyzed manually and corrected as needed.

Appendix A. Notices and trademarks

Notices

Lenovo may not offer the products, services, or features discussed in this document in all countries. Consult your local Lenovo representative for information on the products and services currently available in your area. Any reference to a Lenovo product, program, or service is not intended to state or imply that only that the Lenovo product, program, or service may be used. Any functionally equivalent product, program, or service that does not infringe any Lenovo intellectual property right may be used instead. However, it is the user's responsibility to evaluate and verify the operation of any other product, program, or service.

Lenovo may have patents or pending patent programs covering the subject matter described in this document. The furnishing of this document does not give you any license to these patents. You can send license inquiries, in writing, to:

Lenovo (United States), Inc.

8001 Development Drive

Morrisville, NC 27560

U.S.A.

Attention: Lenovo Director of Licensing

LENOVO PROVIDES THIS PUBLICATION "AS IS" WITHOUT WARRANTY OF ANY KIND, EITHER EXPRESS OR IMPLIED, INCLUDING, BUT NOT LIMITED TO, THE IMPLIED WARRANTIES OF NON-INFRINGEMENT, MERCHANTABILITY OR FITNESS FOR A PARTICULAR PURPOSE. Some jurisdictions do not allow disclaimers of express or implied warranties in certain transactions, therefore, this statement may not apply to you.

Changes are made periodically to the information herein; these changes will be incorporated in new editions of the publication. To provide better service, Lenovo reserves the right to improve and/or modify the products and software programs described in the manuals included with your computer, and the content of the manual, at any time without additional notice.

The software interface and function and hardware configuration described in the manuals included with your computer might not match exactly the actual configuration of the computer that you purchase. For the configuration of the product, refer to the related contract (if any) or product packing list, or consult the distributor for the product sales. Lenovo may use or distribute any of the information you supply in any way it believes appropriate without incurring any obligation to you.

The products described in this document are not intended for use in implantation or other life support applications where malfunction may result in injury or death to persons. The information contained in this document does not affect or change Lenovo product specifications or warranties. Nothing in this document shall operate as an express or implied license or indemnity under the intellectual property rights of Lenovo or third parties. All information contained in this document was obtained in specific environments and is presented as an illustration. The result obtained in other operating environments may vary.

Lenovo may use or distribute any of the information you supply in any way it believes appropriate without incurring any obligation to you.

Any references in this publication to non-Lenovo websites are provided for convenience only and do not in any manner serve as an endorsement of those websites. The materials at those Web sites are not part of the materials for this Lenovo product, and use of those websites is at your own risk.

Any performance data contained herein was determined in a controlled environment. Therefore, the result obtained in other operating environments may vary significantly. Some measurements may have been made on development-level systems and there is no guarantee that these measurements will be the same on generally available systems. Furthermore, some measurements may have been estimated through extrapolation. Actual results may vary. Users of this document should verify the applicable data for their specific environment.

This document is copyrighted by Lenovo and is not covered by any open-source license, including any Linux agreement(s) which may accompany software included with this product. Lenovo may update this document at any time without notice.

For the latest information or any questions or comments, contact or visit the Lenovo Web site:

<https://support.lenovo.com>

Trademarks

Lenovo and the Lenovo logo are trademarks of Lenovo. Microsoft, Windows, OneDrive, Outlook, Skype, Office 365, and Cortana are trademarks of the Microsoft group of companies. DisplayPort is a trademark of the Video Electronics Standards Association. Wi-Fi is a registered trademark of Wi-Fi Alliance. USB Type-C is a registered trademark of USB Implementers Forum. All other trademarks are the property of their respective owners.