

SuperFit

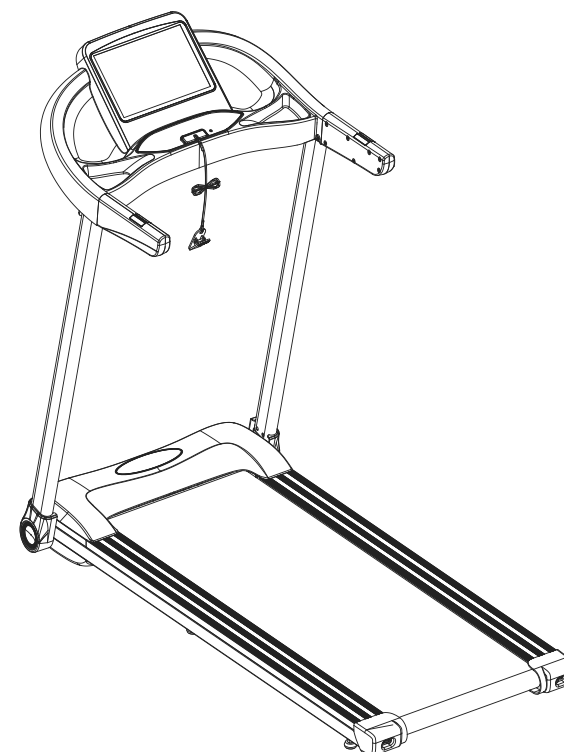

USER'S MANUAL

Treadmill

SP37462

THIS INSTRUCTION BOOKLET CONTAINS **IMPORTANT** SAFETY INFORMATION. PLEASE READ AND KEEP FOR FUTURE REFERENCE.



Please give us a chance to make it right and do better!

Contact our friendly customer service department for help first.

Replacements for missing or damaged parts will be shipped ASAP!

Follow Costway



Contact Us!

Do NOT return this item.

Contact our friendly customer service department for help first.



Before You Start

- ⚠ Please read all instructions carefully.
- ⚠ Retain instructions for future reference.
- ⚠ Separate and count all parts and hardware.
- ⚠ Read through each step carefully and follow the proper order.
- ⚠ We recommend that, where possible, all items are assembled near to the area in which they will be placed in use, to avoid moving the product unnecessarily once assembled.
- ⚠ Always place the product on a flat, steady and stable surface.
- ⚠ Keep all small parts and packaging materials for this product away from babies and children as they potentially pose a serious choking hazard.

1、Safety precautions Warning instructions

NOTE: Please read the instruction carefully before using and pay attention to the following safety precautions.

- ★ The treadmill is suitable to be placed indoors, to avoid moisture, splash water on the treadmill and place any foreign matter.
- ★ Please wear appropriate sportswear and sports shoes before exercise. Don't run barefoot on the treadmill and keep stretching body.
- ★ The power plug must be connected reliably grounded, and the socket must have a dedicated circuit to avoid sharing with other electrical equipment.
- ★ Children should keep away from the machine to avoid accidents.
- ★ It is necessary to avoid overload operation for a long time, otherwise the motor and controller will be damaged. The bearing, running belt and running plate will be worn and aged, please keep regular maintenance.
- ★ Reduce indoor dust, maintain a certain indoor humidity, avoid strong static electricity, otherwise it may interfere with the electronic meter. Keep controller normally working.
- ★ Please turn off the treadmill power after the use of sports.
- ★ Keep the clean and fresh air in the room when you use the treadmill
- ★ Please fasten the safety lock cable clip on the clothes when exercising in case of emergency.
- ★ Please stop exercising and consult your doctor if you feel uncomfortable and abnormal during using.
- ★ Please put silicone oil in a place out of the reach of children to avoid serious consequences caused by accidental ingestion after using the silicone oil.

Warning: Please observe the following regulations in order to reduce accidents or injuries to others.

- ★ Please check your clothing or zipped before using the treadmill.
- ★ Don't wear clothes that can get caught on the treadmill.
- ★ Do not place the power cord near a hot object.
- ★ Keep children away from the treadmill.
- ★ Don't use the treadmill outdoors.
- ★ The power must be cut off before moving treadmill.
- ★ Non-professional personnel shall not open the upper guard cover and the left and right rear housing without authorization.
- ★ This treadmill can only be used in circuit of 15A.
- ★ Only one person can exercise on the treadmill when the machine starts.
- ★ Please stop exercising immediately and consult a fitness instructor when you feel dizziness, chest pain, nausea or shortness of breath during exercise.

Warning! Enforcement!

Please be sure to discuss with a professional doctor before using if you are receiving medical treatment from a doctor or the following patient.

- (1) Having back pain now or injury for leg, waist and neck in the past and the people who have problem with Leg (those with chronic diseases such as disc herniation, spondylolisthesis, cervical herniation)
 - (2) Having deformed sex arthritis, rheumatism, gout.
 - (3) Abnormal people with osteoporosis.
 - (4) Having circulatory system obstacle (disease of heart, blood-vessel, hypertension)
 - (5) Having difficulty in breathing.
 - (6) Using artificial pacemakers or implantable medical electronic devices.
 - (7) Having malignant tumors.
 - (8) Having thrombosis or serious dynamic environment tumor, acute environment tumor and other blood circulation disorders or a variety of skin infections and other symptoms.
 - (9) Having perceptual disabilities caused by diabetes and high peripheral circulation disorders.
 - (10) Having skin injuries.
 - (11) Having a high fever (38°C or above) due to illness and so on.
 - (12) Having abnormal dorsal bones or crooked dorsal bones.
 - (13) Having pregnancy or possible pregnancy or menstruation.
 - (14) Feeling abnormal and have to rest
 - (15) Poor physical condition obviously
 - (16) Users for rehabilitation purposes.
 - (17) Feeling uncomfortable in a certain region of the body except the above circumstances.
—It's likely to cause accident or poor health.
- ◆ Please stop using immediately and consult your doctor when you feel pain in your back, numbness in your legs, dizziness, abnormal heartbeats and other body aches that are different from normal or poor coordination or other abnormal feelings during exercise.
 - ◆ Do not allow children to use or play around the product.
—If not followed, there may be a risk of injury.
 - ◆ Do not allow children to play with this product for child protectors.
—If not followed, there may be a risk of injury.
 - ◆ Please make sure if there is person or pet around (rear, lower, front) during using or taking out product.

Prohibition

- ◆ Do not use in the state of shell cracked, detached (internal structure exposed) or weld detached.
—Otherwise, it's easy to cause accident or injuries.

- ◆ Do not jump up or down during exercise.
—It's likely to fall or cause injury.
- ◆ Do not use or keep in damp places such as outdoors or near the bathroom, or in places where water drops are caught.
- ◆ Do not use or keep in places with direct sunlight such as high-temperature places of around the stove and heating appliances of electric heating carpets.
—Otherwise, it's easy to cause electricity leakage, fire.
- ◆ Do not use when the power cord or plug is damaged or the socket is loose.
—Otherwise, it's easy to cause electric shock, short circuit and fire.
- ◆ Do not damage or forcibly bend or twist the power cord. At the same time, do not place heavy objects on it or not let the line be clamped.
—Otherwise, it's easy to cause fire or electric shock
- ◆ Do not use it with two or more people at the same time. Do not let the people around get close when using.
—Otherwise, it's easy to cause accident and injuries from falls.
- ◆ Do not use it if you can't express consciousness by yourself or operation.
—It's likely to cause accident or injury.

Do not disassemble the treadmill.

- ◆ Disassembly, repair or re-election are strictly prohibited
—There is a risk of injury due to mechanical failure

Avoid touching with water

- ◆ Do not spray water or other conductive liquid on main body or operation part.
—It may cause electric shock and fire.

Prohibition

- ◆ People who don't usually exercise shouldn't suddenly do strenuous exercise.
- ◆ Do not use after eating or when you are tired. Especially after exercising or when you are in an abnormal physical state.
—It may cause damage to health.
- ◆ This product is suitable for the home use, do not use in the school, the gymnasium and so on or for non-specific users.
—There would be injury risk.
- ◆ Do not use when eating, drinking, or other activities.
- ◆ Do not use it after drinking until you feel sluggish.
—It's easy to cause accident or injury.
- ◆ Do not use it with something hard in your pants pocket.
—It's easy to cause accident or injury.

- ◆ Do not use the power plug with needles, garbage or water.
—It may cause electric shock, short circuit and fire.
- ◆ Do not pull out the power plug or switch the power switch to "off" during use.
—It may cause injury.

Never use it with wet hands

- ◆ Do not pull out or insert the power plug with wet hands.
—It's likely to cause electric shock or injury

Pull out the power plug

- ◆ Please pull out the power plug from socket when you don't use it.
—Dust and moisture make its insulation deteriorate and lead to electricity leakage and fire.
- ◆ Please be sure to pull the power plug from the socket during maintenance.
—Failure to comply may result in electric shock or injury.
- ◆ Please stop using it if the device does not start or runs abnormally. Immediately pull out the power plug and entrust inspection and repair.
—Failure to comply may result in electric shock or injury.
- ◆ Pull out the power plug immediately in case of power failure.
—Otherwise it's likely to occur accidents or injuries when the power restored.
- ◆ Do not hold the cable tight. Hold the power plug to pull out the plug.
—Otherwise, it may cause short circuit, electric shock and fire.

Grounding instructions

- ◆ The product must be grounded. Grounding provides the channel with the least resistance to current to minimize the risk of electric shock if the function of this machine does not work normally.
- ◆ This product is equipped with a grounded conductor and a plug for the device. The plug must be properly installed, grounded and plugged into an appropriate electrical outlet in accordance with local codes or regulations.

Dangerous

- ◆ There is a risk of electric shock if the device is not properly grounded. Please contact an electrician to check if the grounding of the product is correct, if the plug does not fit into the socket it can not be changed. Please inform a qualified electrician with the installation of a suitable socket.
- ◆ This product has a grounding plug. Make sure that the product is connected to an outlet of the same shape. this product can not be used with an adapter socket.

2、Exploded-Views

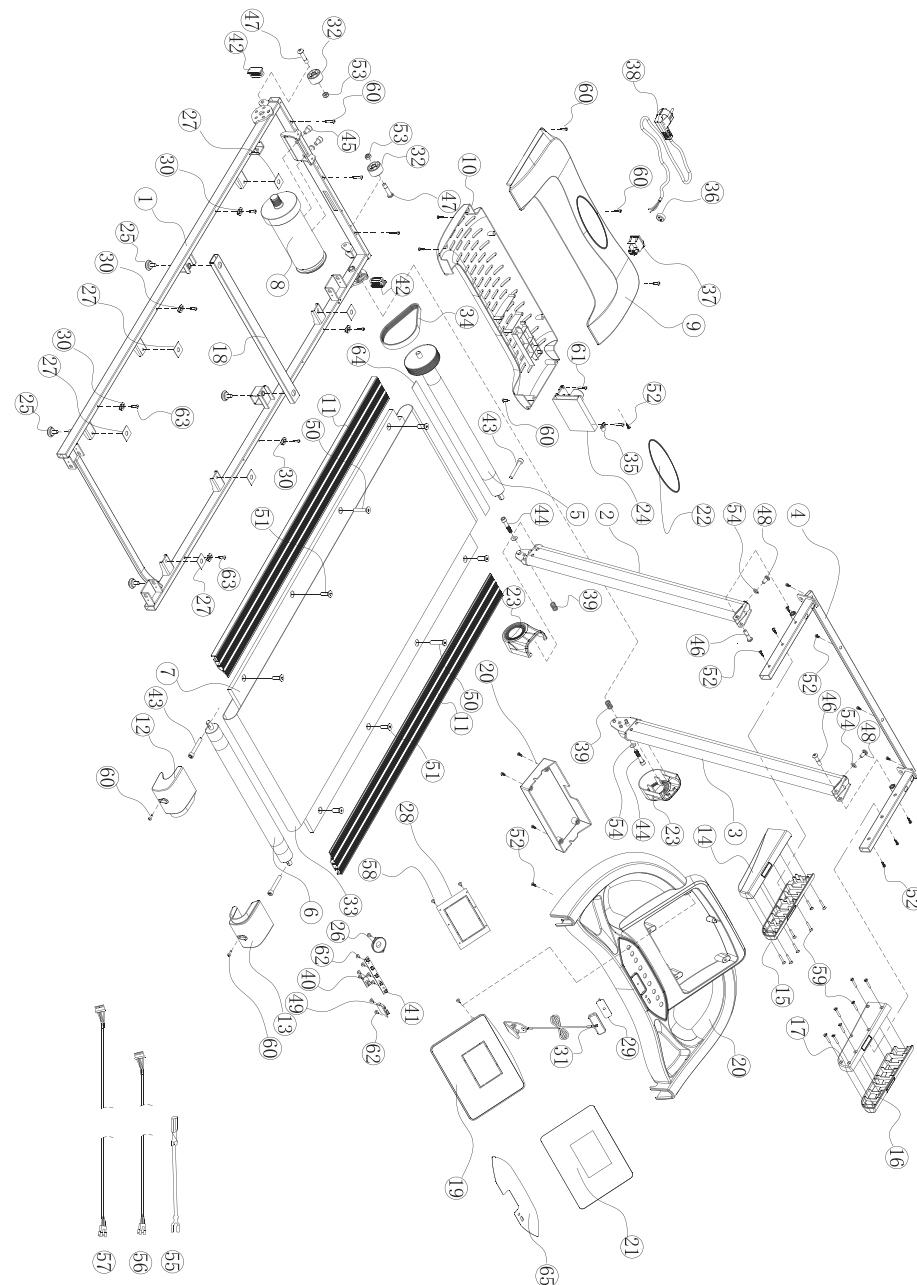

3. Details of Exploded-Views

No.	Name	QTY	NO.	Name	QTY.
1	Main frame	1	35	Wire clamp	1
2	Left Riser	1	36	Power Cord Clip	1
3	Right Riser	1	37	Rocker switch	1
4	Computer Frame	1	38	Power Cord	1
5	Front Roller	1	39	Spring	2
6	Rear Roller	1	40	Safety lock sensor	1
7	Running Deck	1	41	Buttons Key Board	1
8	Motor	1	42	Square pipe plug	2
9	Upper guard	1	43	Hexagon socket head screwM8×55	3
10	Lower guard	1	44	Hexagon socket head half-thread screw M8×40	2
11	Side Edging	2	45	Hexagon socket head screw M8×12	2
12	Decorative cover for left rear tailstock	1	46	Hexagon socket pan head half-thread screw M8×30	2
13	Right rear tailstock decorative cover	1	47	Hexagon socket pan head screw M8×35	2
14	Left handle outer cover	1	48	Hexagon socket pan head screw M8×16	2
15	Left hand handle inner cover	1	49	USB	1
16	Right handle outer cover	1	50	Hexagon socket countersunk head screwM8×35	2
17	Right handle inner cover	1	51	Hexagon socket countersunk head screw M8×20	6
18	Main frame middle horizontal tube	1	52	Cross recessed pan head tapping screw4.2×16	21
19	Display fixing frame (choose one of two)	1	53	Hexagon lock nut M8	2
20	Computer Bottom Case	1	54	M8 gasket	6
21	Computer Display Sticker	1	55	Communication line	2
22	Upper Shield Sticker	1	56	Upper section of communication line	1
23	Riser Lower cover	2	57	Lower section of communication line	1
24	Controller	1	58	Cross recessed pan head tapping screw2.9×6.5	16
25	Footpad	4	59	Cross recessed countersunk head tapping screw 4.2×30	14
26	Speaker	1	60	Cross recessed pan head tapping and self-drilling screws4.2×16	21

27	Running Board Rubber Pad	1	61	Cross recessed pan head tapping screw 4.2×22	2
28	Computer PCB Board	1	62	Cross recessed flange head tapping screw 2.6×9	10
29	Safety key iron plate	1	63	Cross recessed countersunk head tapping and self-drilling screws4.2×16	6
30	Side Edging Block	6	64	EVA adhesive tape	1
31	Safety key Sets	1	65	Button sticker	1
32	Moving Flywheel	2			
33	Running Belt	1			
34	V-belt	1			

4. Product introductions

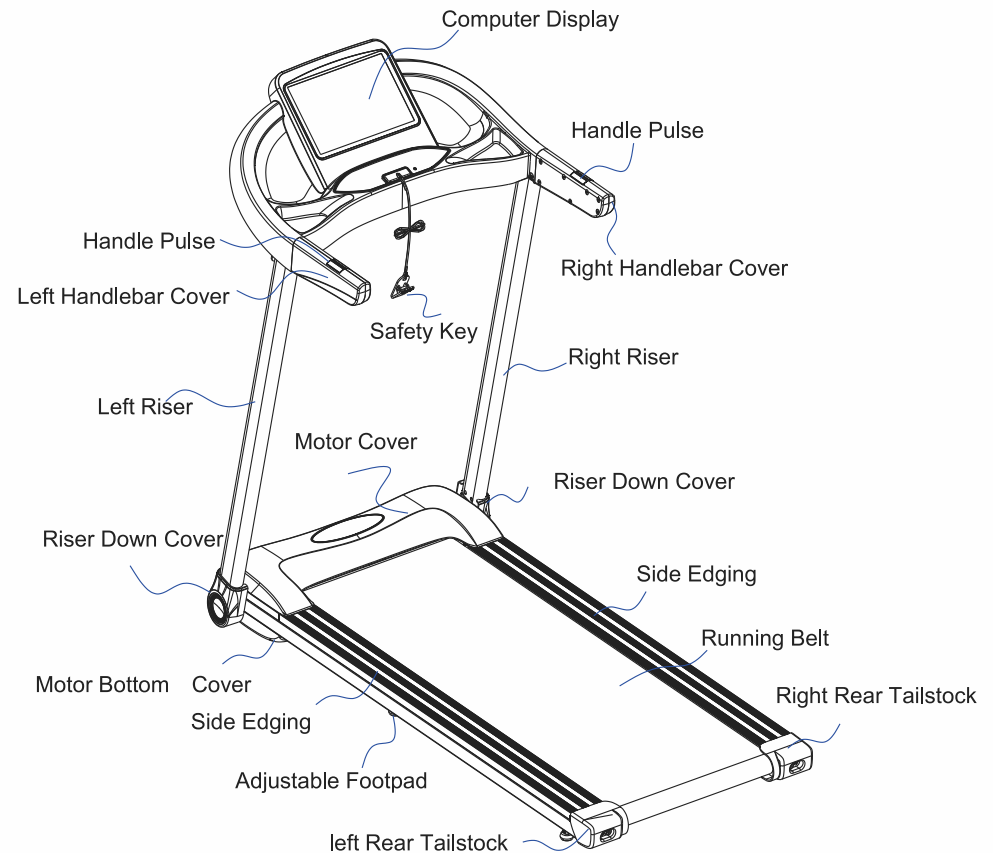

Packing list

No	Item name	Qty.	Notes
1	Main machine	1	
2	Riser down cover	2	
3	Spare parts package	1	See spare parts list table

Technical parameters

working voltage	AC-110V 60Hz
maximum load	220 lbs
dimensions	L51*W26.3*H43.1 inch
running area	43.3*16.5 inch
motor peak power	2.25HP
speed	0.62-7.5 mph

Schedule (list of accessories)

No.	Name	QTY	Notes
1	M8*16 hexagon socket pan head screw	2	Fix the computer display and the riser
2	Φ8 gasket	2	Fix the computer display and the riser
3	5mm Allen key	1	Assembling machine
4	6mm Allen key	1	Lock the main frame and the riser, adjust the running belt
5	Safety Key	1	
6	Silicone oil	1	
7	Footpad	4	
8	Manual, Certificate of Conformity	Each*1	

5. Installation procedure

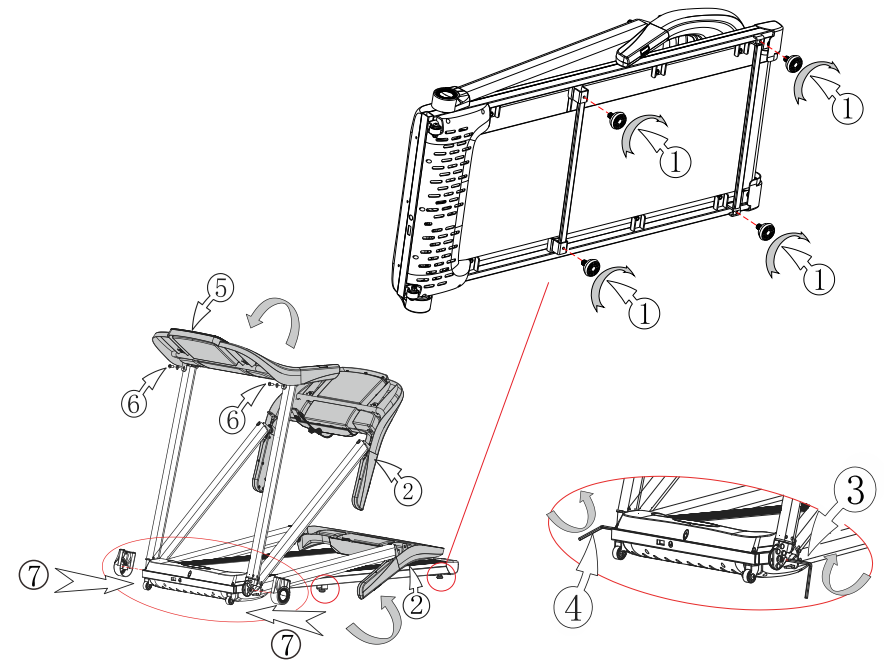

1. Take the main machine out of the carton box and lay it flat on the carpet or soft cushion. As shown in Figure ① above, put the main machine on its side, screw the four footpads clockwise into the screw holes on the back sides, and then lay it flat. As shown in step ②⑤ in the figure above, lift the riser up, and turn the computer display to the position shown in the figure (don't press the communication line when the computer display component is put down, To prevent damage to the lines when installing screws). Step ③④Use the "6MM Allen key" to lock the left and right risers to the frame. Step ⑥ Use "M8*16 hexagon socket pan head screws" and M8 washers to lock the computer display on the left and right risers. Step ⑦ After confirming that the riser is locked, fasten the lower cover of the riser on the left and right risers respectively.

2. As shown in step ⑧ above, the safety key " is drawn into the yellow position of the computer display, and the installation is complete; Turn on the power, turn on the power switch under the front of the machine, and enter the standby state.

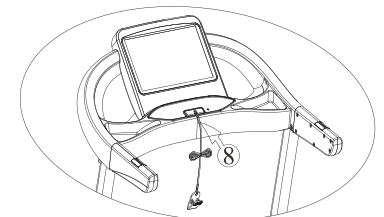

Note: After the machine is assembled, please check again whether all bolts are locked.

6. Sports advice and guidelines

warm-up exercise

warm up for 5-10mins before each operation

Breathe

Do not hold your breath during operation. Normally prepare to release action and inhale through the nose, exhale through the mouth. The breathing should be coordinated with movement. If the breathing is too rapid, the movement should be stopped immediately.

Frequency

The exercise of the same muscle should keep 48hours of rest. That is , only train the same area every other day.

Load

Determine the amount of training according to the individual physical condition, and then practice according to asymptotic load. It is normal phenomenon for muscle soreness at the beginning of training. As long as continue to practice the soreness can be eliminated.

Relax

The reductive action should be done for 5mins after practicing every time. Especially extend flabby for ministry muscle. avoid muscle long-term condensation, and keep muscle flexibility.

Diet

Do not eat at least 1 hour before training and half an hour after training to protect your digest system. Avoid drinking plenty of water to avoid increasing burden of heart and kidney.

Stretching exercise

It is important to stretch before training, no matter how intense the training will be. It is easier to stretch the muscles when they are warm. warm up by running for 5 to 10 minutes and then stop and stretch as follows 5 times for 10 seconds or more on each leg. continue to stretch even after training. Do it again after you work out.

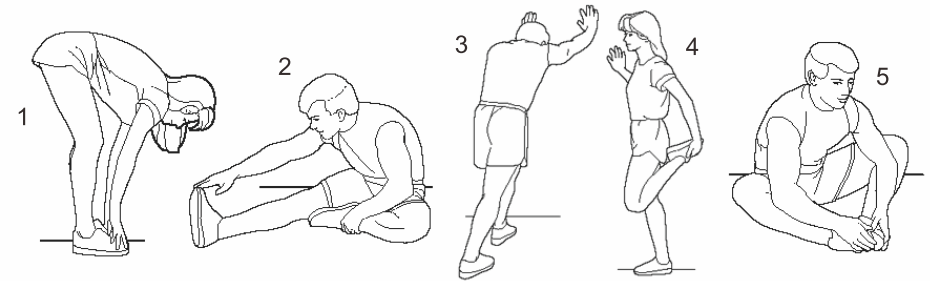

1. Stretch down

Bent your knees slightly and slowly bend your body to relax your back and shoulders. And try to touch your toes with your hands. Hold for 10-15 seconds, then relax. Repeat three times (see figure 1)

2. Hamstring stretch

Sit on a clean seat cushion and straighten one leg. Bring the other leg in close to the inside of the leg. Try to touch your toes with your hands. Hold for 10-15 seconds, then relax. Repeat with each leg three times (see figure 2)

3. Stretch the calf and hamstring

Stand with two hands on a wall or tree. One foot is behind. Keep your hind legs straight and on your heels, leaning against a wall or tree. Hold for 10-15 seconds. And then relax. Repeat 3 times for each leg. (see figure 3)

4. Quadriceps stretch

Keep balance with left hand to hold the wall or table. Then extend your right hand backward. Hold your right ankle and slowly pulling toward your hips until you feel tension in front of your thighs muscles. Hold for 10-15 seconds, then relax. Repeat 3 times with each leg (see figure 4)

5. Sartorius muscle (muscle of the inner thigh) stretch

Sit with your feet facing each other and knees facing out. Grab both feet with both hands and put toward the groin. Hold for 10-15 seconds. Then relax, repeat 3 times (see figure 5)

7. Instructions

How to use the treadmill

1. Turn on the power and check if the machine is normal.
2. the machine sets the running speed of the running belt to 0.62-7.5 mph
3. Clip the safety lock on the placket on the chest of the athlete.
4. Before exercise, check the stability and function of the treadmill. It is strictly forbidden to stand on the running belt to start the treadmill. Before running, stand on the left and right bars, hold the handrail, and then step into the running area after starting normally. Take the belt for exercise. When starting up, grab the handrail with one hand and press the "START" button on the electronic watch with one hand. The treadmill will start at 3 seconds and run at 0.62mph. Press "+", the motor speed rises to reach the speed of 1.55~2.17mph (this is the most comfortable speed to learn running), both hands grab the armrests at the same time, both feet step on the running belt, and will soon be able to run With the same speed.
5. After a few minutes, you can increase the running speed, press the "+" button on the digital meter to increase the speed slowly; or press the "-" button to decrease the speed.
6. You can stop the motor at any time by pressing the "STOP" button on the digital meter during the movement.
7. After starting the machine, press the "3mph" speed direct selection button directly at any speed, then the running speed of the running belt is 3 mph .

Note: During the movement, the safety lock is pulled off, the running opportunity stops running immediately, the electronic watch refuses any operation, and the window displays "E07".

The display window and button description

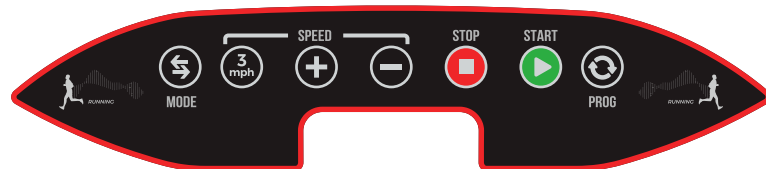

1. LED window shows the following functions:

Time / speed / distance / calorie / pulse window: 5 seconds to switch display time, speed, Heart Rate distance and calorie data,

Time display range: 0:00-99:59, Speed display range 0.62-7.5 mph
 Distance display range: 0.00-99.99. Calorie display range: 0.00-999.9
 Heart Rate display range:50-200.

2. Electronic watch function button: 3 mph, speed +, speed -, stop, start, program, mode
 - A. 3mph: After starting up, press this speed direct selection button directly at any speed, then the running speed of the running belt is adjusted to 3mph .
 - B. SPEED+: During the exercise, the button will increase the speed.
 - C. SPEED-: During the exercise, the button will slow down the speed.
 - D. Stop: press this button in the running state, the treadmill decelerates to stop.
 - E. Start: Press this button in the stop state, it will start the running belt.
 - F. Program key: In the stop state, press the program key to cycle through the program: manual mode->P01->P02->P03->P04->P05->P06->...P11->P12.
 - G. mode key: when the manual mode is selected, the speed window displays the initial value of 0.0, and the mode key can be cycled to select the countdown mode window display in the manual mode. 30:00->countdown distance mode window display 1.0-> Countdown Calorie Mode Window Display 50->Normal Mode.

The startup instructions

1. Place the security lock on the panel, turn on the power switch, and the buzzer will sound. Then enter the manual normal mode.
2. Press the start button, the time window displays 3 seconds countdown, and each time the buzzer is sounded, the motor is started.
3. The starting speed is: 0.62 mph. At this time, you can press the speed +, - keys to adjust the speed and the 3 mph speed direct selection button.
4. Run in normal mode, time is running at regular timing, speed is fixed, can be adjusted manually
5. Heart rate test, hold the light hand grip with both hands, and have a heart rate display in heart rate window after a few seconds. (Heart rate data is for reference only and cannot be used for any medical-related purposes)

The security lock function

In any state, the safety lock is pulled off, the window displays "E07", and the buzzer BI-BI-BI rings three times. If the motor is running, the motor is stopped urgently. When the safety lock is off, it cannot be started.

Power saving mode

The system has a power-saving function. If there is no key command input within 10 minutes in the standby state, the system enters the power-saving mode, automatically turns off the display, and presses any key to wake up the system again.

8. Common failures and processing method

please call our dealer or our after-sales service if you have any other questions

questions	Possible causes	maintenance methods
treadmill don't work	not connected	put plug to insert socket
	Power is not turned on	Put the power switch in position "ON"
	safety lock drop	put the safety lock in correct position
	circuit signal system break	check the controller input terminal and signal circuit
	the fuse blew out	replace fuse
the running belt doesn't run smoothly	insufficient lubrication	add silicone oil lubricant
	Belt is too tight	adjust belt tightness
running belt slipped	running belt too loose	adjust running belt tightness
	running belt too tight	adjust running belt tightness

Error messages on electronic meter and elimination methods

questions	possible cause	maintenance methods
E01	poor communication	The signal line is not plugged it. Plug it again
E02	power assault	power tube breakdown, replacement of electronic control
E03	Non-sensing signal	sensing wire is not plugged in properly. Plug it again correctly
E04	controller or motor abnormal	overload, replace controller or motor
E05	overload protect	overload, replace controller
E06	system self-check failed	system failure, replace controller
E07	safety lock drop	put the safety lock in correct position
abnormal display	external disturbance	turn off power switch, turn on it after one minute

9. Product maintenance

1. lubrication

When the running machine is used for a period of time, it must be lubricated with special methyl silicone oil.

Advice:

- ★ 1 hour or less per week lubricate once every 6 months
 - ★ Less than 3 hours per week lubricate once every 3 months
 - ★ 3-6 hours per week lubricate once every 2 months
- More than 6 hours per week lubricate once a month

Do not lubricate too much. It is not the more lubricants the better.

Remember: Proper lubrication is an important factor in improving the life of the treadmill.

2. As for the way to check if you need to add lubricant.

Just grab the running belt and touch the middle of the running belt back with your hands as much as possible. You don't need to add lubricant if you have silicone on your hand (a little damp) You have to add lubricant if the pad is dry and there is no silicone on your hand.

- ★ the step of lubricate on the running plate (as shown in the right picture)
- ★ Stop running and fold the machine.
- ★ Lift the running belt of the underside of the main body, Put the oil pot as far as possible into the middle of the running belt. And spray methyl silicone oil inside of the running and both sides.
- ★ You can make use of the treadmill speed of 1km/h to evenly lubricate and step on the running belt from left to right. After a few minutes, the methyl silicone oil can be completely absorbed by the running belt.

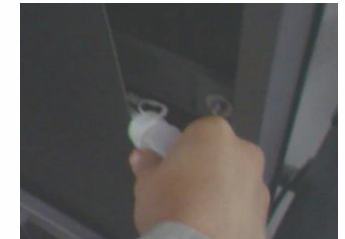

3. Adjust tightness of running belt, All treadmills shall be adjusted for tightness before delivery and after installation. However, the running belt may be loosened after a period of use. For example, The treadmill had stopping and slipping question during exercise. Adjust bolts of running belt with the left and right synchronous as per clockwise direction to half a circle as the unit when this phenomenon occurs. The feet will slip if the running belt is too loose. But it is not good to be too tight. It is easy to increase the load of the motor and damage the motor, running belt and roller etc.

4. Running belt deviation adjustment

All treadmill belts need to be adjusted before delivery and after installation. But the running belt may be deviated after a period of use which may be caused by the following reasons.

- ① The main body is not placed smoothly.
- ② The feet of users are not in the center of the running belt.
- ③ The feet of users are uneven force

It will be returned to normal after a few minutes of no-load rotation if deviation is caused by man-made. It should be adjusted with 6mm wrench at a half circle as the unit for deviation of non-recover automatically.

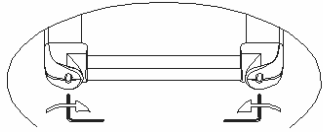

Please adjust left bolt clockwise or right bolt counterclockwise if running belt is left deviation.

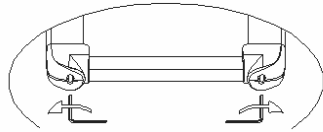

Please adjust right bolt clockwise or left bolt counterclockwise if running belt is right deviation.

The running belt deviation is not within the scope of warranty. And it is mainly maintained by the user according to the manual. Running belt deviation will seriously damage the running belt. The mistake must be found in time and corrected.

5.Adjustment of motor belt (as shown in the right picture)

All treadmills have been adjusted for the motor belt before and after installation, but they may still be out after a period of use. Now the phenomenon of loose slip, mainly by the user to adjust.

Adjustment steps:

- ① Adjust the parallelism of the motor with a wrench. Turn the bolt half a turn counterclockwise.
- ② Turn the belt tightening bolts clockwise half a circle.

NOTE: clean belt and pulley grooves regularly.

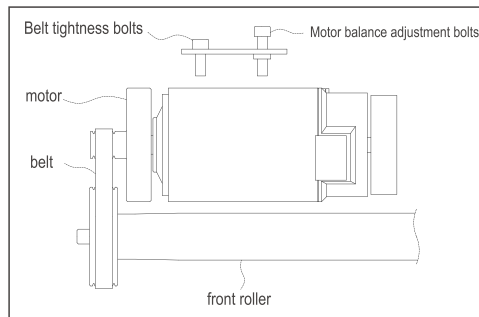

10. Service commitment

Electric treadmill, If no-human damage, can be free for users to come to repair or provide accessories in one year use under normal circumstances. After the warranty period can be appropriate to provide free labor maintenance cost. Spare parts prices from preferential. Please refer to the warranty card for details.

Important information

The warranty card of this machine comes with each product. Which is filled by the dealer. Free replacement parts within the warranty period. Such as incorrect installation, incorrect use or replace facilities caused by the fault, our company will not be responsible for them. In addition, this warranty card is not applicable to people who do not have the authorization of the company for maintenance. The customer afford this cost by themselves if resulting maintenance costs like this. The user must issue the invoice when maintaining. The guarantee is invalid if there are not any bill or guarantee card. This product is only for home use. We are not responsible for any problems caused by commercial use. Please call our dealers or our after sales service if your products need maintenance service.

Gymax App Instruction Manual v1.0.2

This document is applicable to the Android version and iOS version of the official APP of Gymax.

iOS: Search Gymax in App Store to download

Android: search and download from Google Play store

Functions Overview

Gymax App iOS/Android with Gymax platform provides users the control of sports intelligent device, sports data recording, sports mall, dynamic sharing in community, system Settings and other functions.

The Main functions

- > Sign In
- > Sports Scenes
- > Sports Mall
- > Community Dynamic
- > Settings

Sign in Process

Sign in
For the convenience of users, Gymax provides three login methods: Facebook and E-mail, and iOS users can also Sign in with Apple. Users can quickly sign in to the Gymax App and use it.

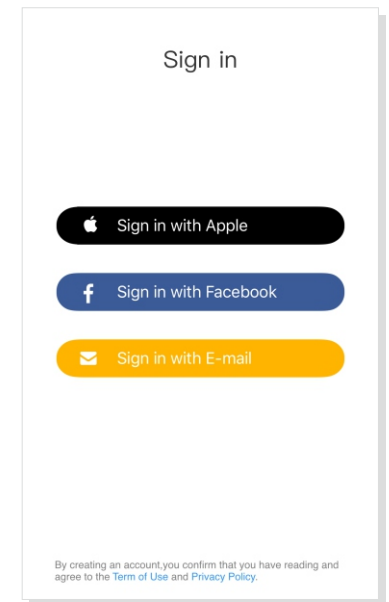

Retrieve Password

If E-mail users forget Passwords, users can click "Forget Password" on the mailbox login interface to jump to the Password retrieval interface, and then reset Passwords.

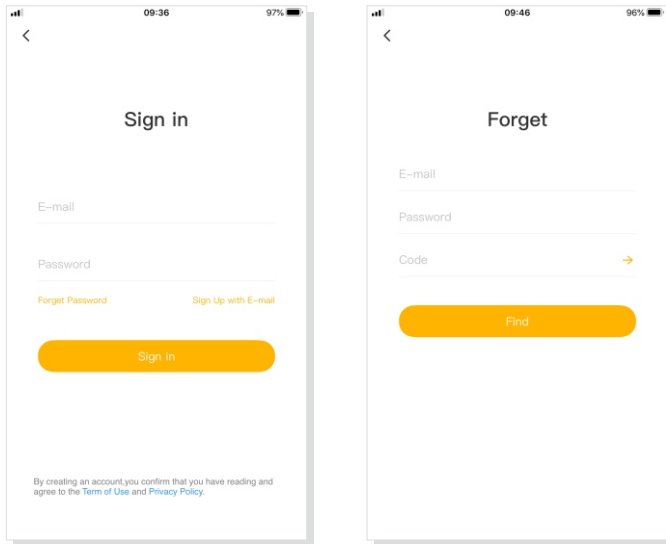

Edit Information

In the personal information interface, clicking the avatar, users can edit the avatar and upload the avatar by choosing album or camera.

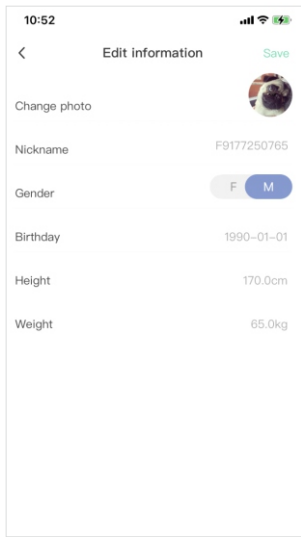

Sports Scenes

Connecting services

On the home page, users can freely choose the device type to connect. After connecting successfully, users then start the device page, such as the "Treadmill" interface.

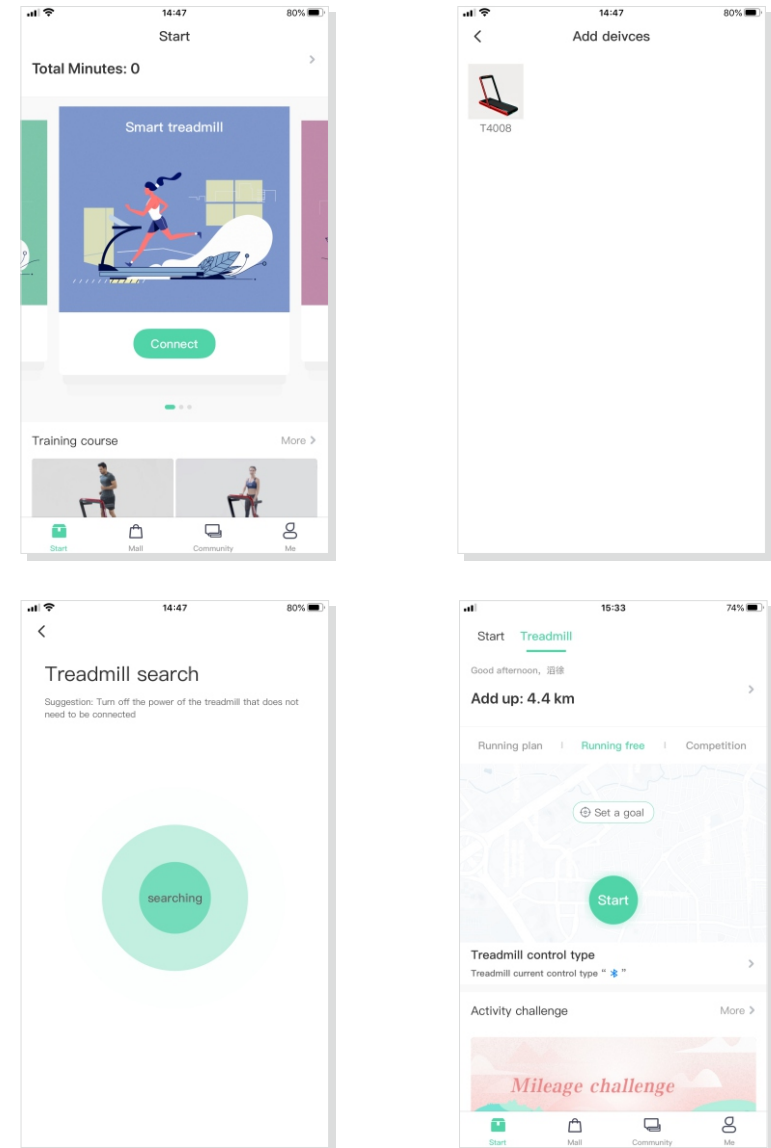

Starting exercise

Selecting the device page, such as "Start" on the "Treadmill" interface, users enter the running free, as shown below:

1. Waiting for GyMax to automatically connect to the treadmill.

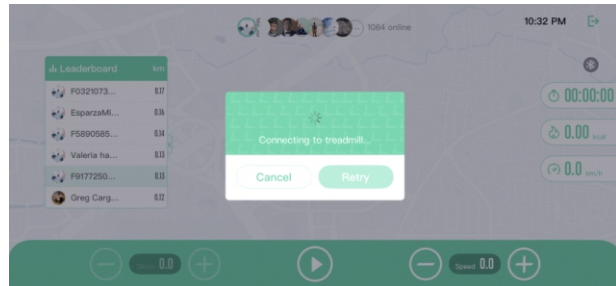

2. When the connection status sign  is lit, it means that the APP has successfully connected to the treadmill. Users click , then the treadmill start Running and enter the countdown. 3.2.1 GO.

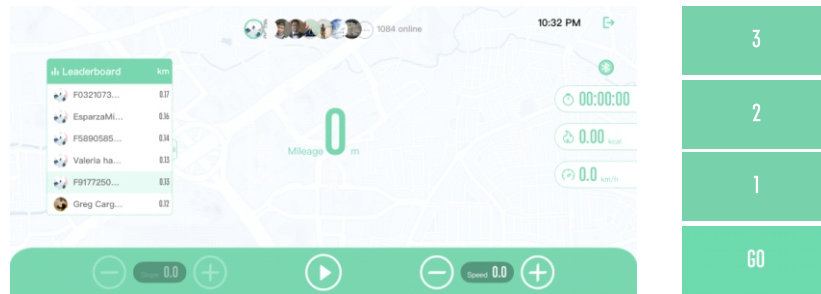

3. The Gymax App synchronizes exercise data, such as mileage, duration, calories, and speed, as users run on the treadmill, and users can start or stop, accelerate or decelerate the treadmill, which intuitively shows users' current sports ranking and the number of online sports in real time.



4. When users finish the exercise, the Gymax App will show users' total mileage.

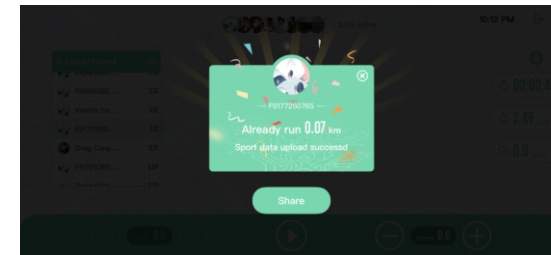

5. Users can share the sports data to the community or save it to the phone album.

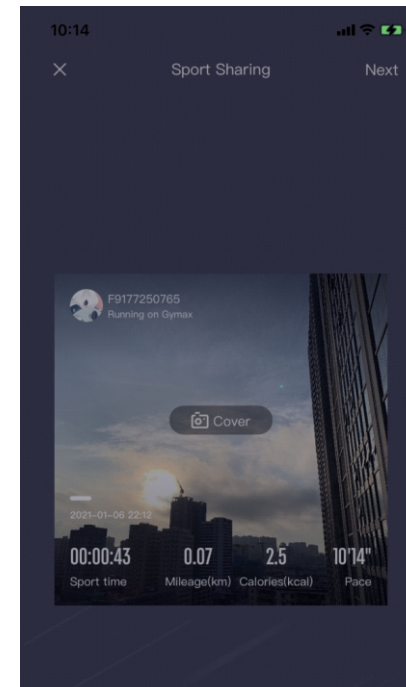

Sports Plan

Users can click "Add More Training Plans" to Add users' own sports plans.

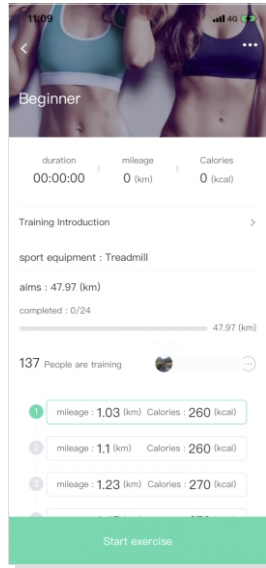
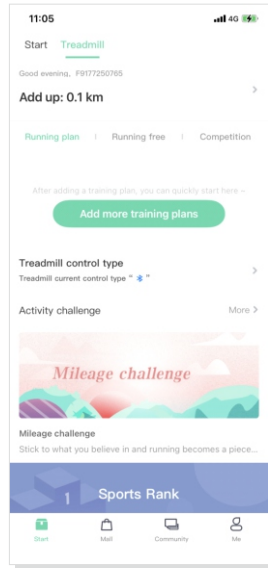

Setting Goals

1. Users can set suitable sports goals.

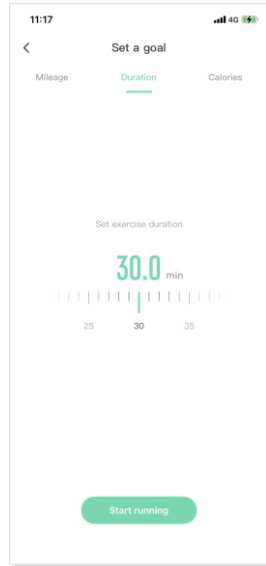
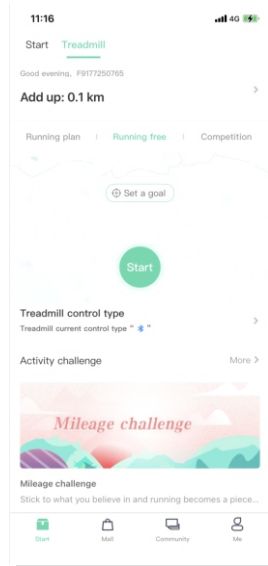

2. When the goal is reached, the exercise automatically ends.

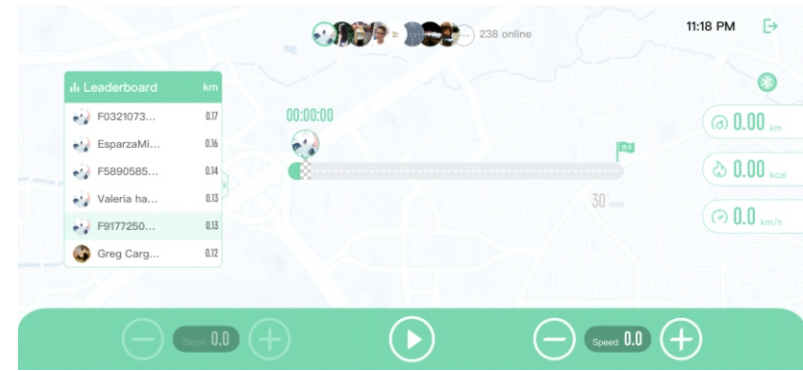

Training Course

1. Users can select courses in the interface of training course.

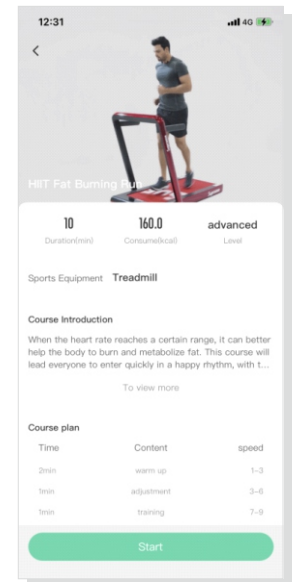
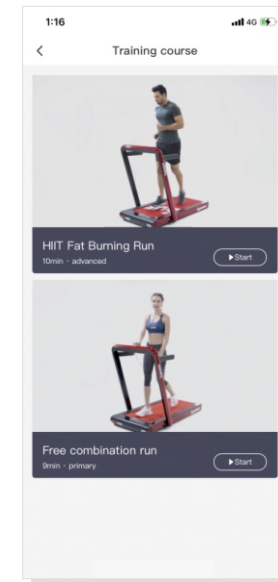
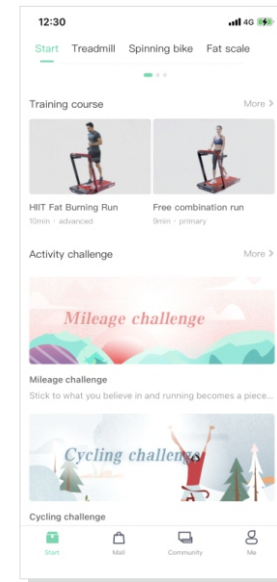

2. And then Start training with a fitness coach.

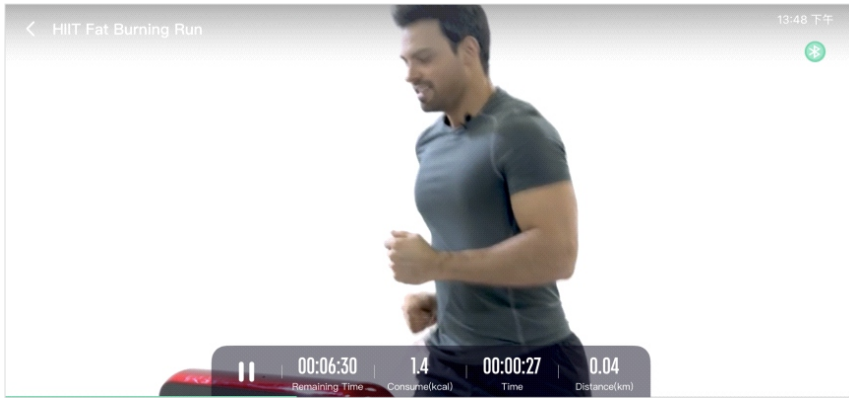

Exercise Record

The user can view the Exercise data record in the device page. (me-exercise data)

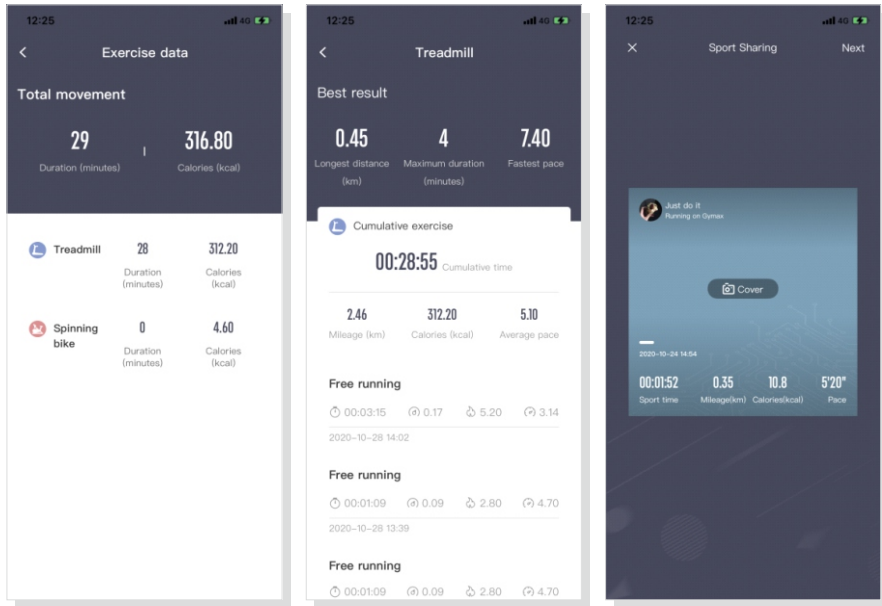

Sports Mall

Users can purchase satisfied sports devices.

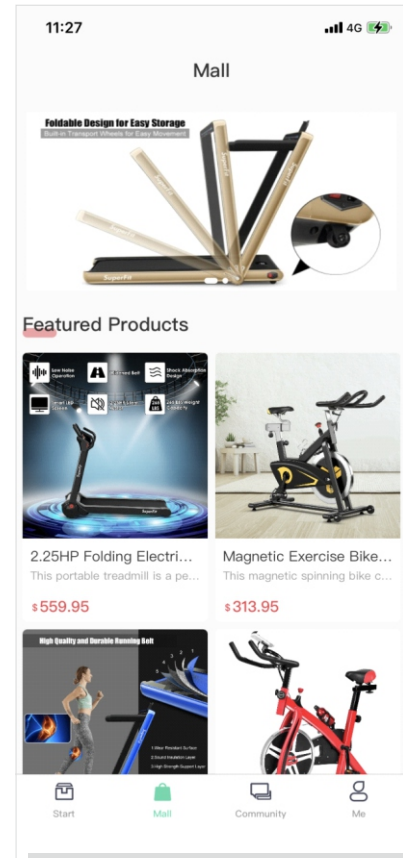

Community dynamic

1. In sports community, users can share dynamic communication with each other.

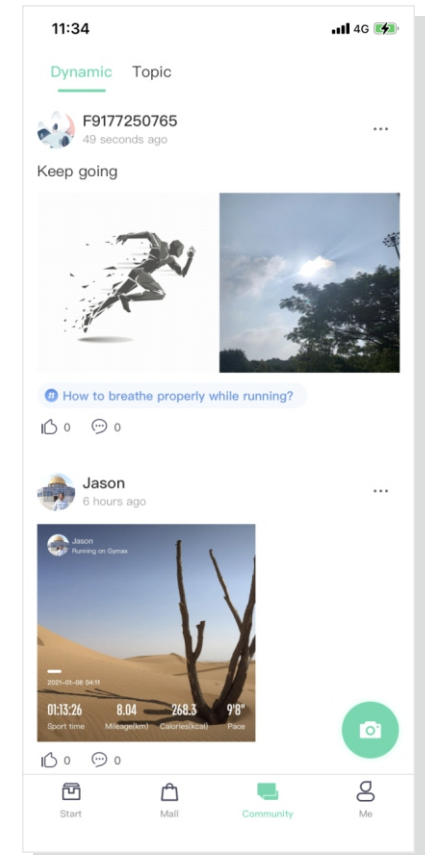

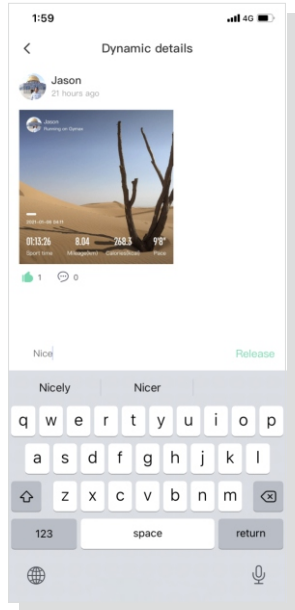

2. Users can comment dynamics in community.

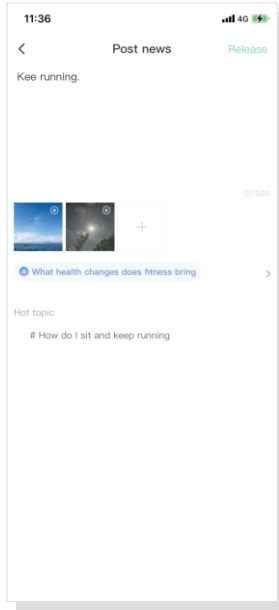

3. Users can post dynamics.

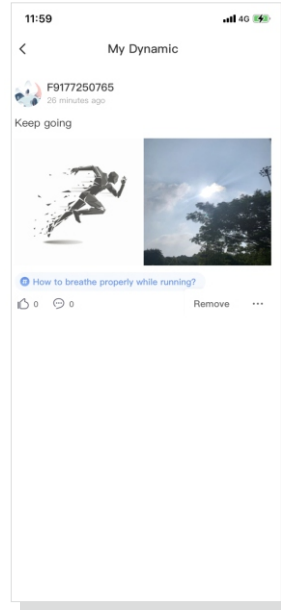

4. Users can remove the released dynamics in Me-My Dynamic.

Settings

System Settings

Users can click "Me" to enter the set up, including unit, feedback, terms of agreement, privacy agreement and clear cache, etc.

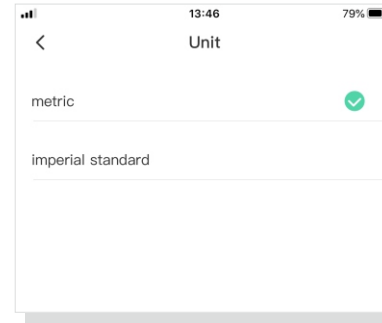
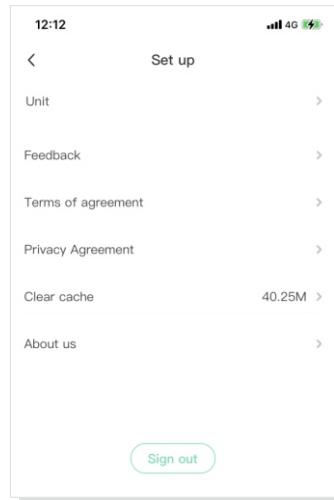

Unit settings (metric or imperial standard)

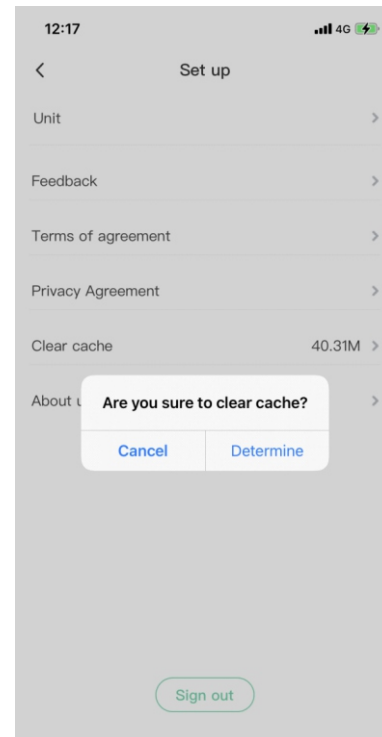

Clear Cache

Users can clean up the system cache according to users' needs, including Gymax App H5 web page load cache and image load cache.

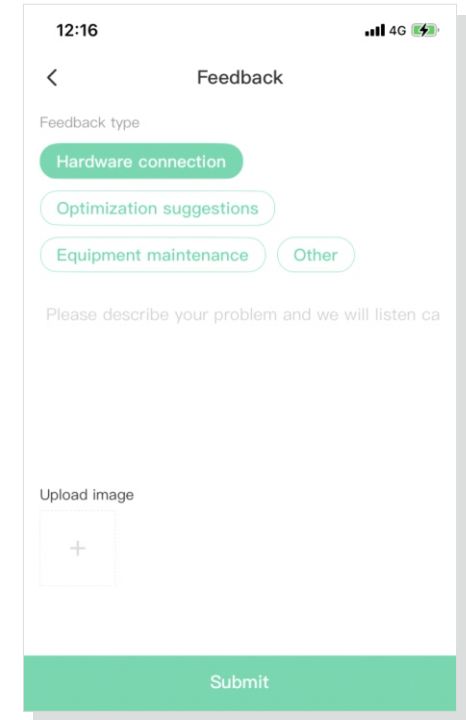

Feedback

Users can submit suggestions and the problem for improving the product.

Welcome to visit our website and purchase our quality products!

With your inspiring rating, COSTWAY will be more consistent to offer you
EASY SHOPPING EXPERIENCE, GOOD PRODUCTS and EFFICIENT SERVICE!

US office: Fontana, California

UK office: Ipswich

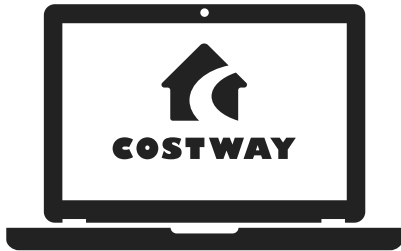

- * Reward Points
- * Exclusive Customer Service
- * Personalized Recommendations
- * Permanent Shopping Cart
- * Order History

5 Star Rating



We would like to extend our heartfelt thanks to
all of our customers for taking time to assemble
this product and giving us valuable feedbacks.

