

INSIGNIA™

3.2 L & 5.5 L Digital Control Air Fryer

NS-AF32DBK9/NS-AF55DBK9/NS-AF55DBK9-C



3.2 L Air Fryer (NS-AF32DBK9)



5.5 L Air Fryer (NS-AF55DBK9/NS-AF55DBK9-C)

Contents

Introduction	2
IMPORTANT SAFETY INSTRUCTIONS	3
Features	6
Package contents	6
3.2 L Air Fryer (NS-AF32DBK9)	6
5.5 L Air Fryer (NS-AF55DBK9/NS-AF55DBK9-C)	6
Control and display panel	7
Before using your fryer for the first time	7
Using your air fryer	8
Preset food temperatures and times	9
Food preparation temperatures and times	10
Making homemade fries	11
Removing the basket	11
Cleaning your air fryer	11
Storing your air fryer	11
Troubleshooting	12
Specifications	14
ONE-YEAR LIMITED WARRANTY	15

Introduction

Congratulations on your purchase of a high-quality Insignia product. Your NS-AF32DBK9/NS-AF55DBK9/NS-AF55DBK9-C represents the state of the art in air fryer design and is designed for reliable and trouble-free performance.

IMPORTANT SAFETY INSTRUCTIONS

When using electrical appliances, basic safety precautions should always be followed, including the following:

- 1 Read all instructions.
- 2 Do not touch hot surfaces. Use handles or knobs. Use oven mitts or potholders.
- 3 To protect against electric shock do not immerse the cord, plugs, or appliance in water or other liquid.
- 4 This appliance is not intended for use by persons (including children) with reduced physical, sensory or mental capabilities, or lack of experience and knowledge, unless they have been given supervision or instruction concerning the use of the appliance by a person responsible for their safety.
- 5 Children should be supervised to ensure that they do not play with the appliance.
- 6 Unplug the fryer from the outlet when not in use and before cleaning. Allow it to cool before putting on or taking off parts, and before cleaning the appliance.
- 7 Do not operate any appliance with a damaged cord or plug or after the appliance malfunctions, or has been damaged in any manner. Bring it to a qualified technician for examination, repair, or electrical or mechanical adjustment.
- 8 The use of accessory attachments not recommended by the appliance manufacturer may cause injuries.
- 9 Do not use outdoors.
- 10 Do not let the cord hang over the edge of the table or counter, or touch hot surfaces.
- 11 Do not place on or near a hot gas or electric burner, or in a heated oven.
- 12 Extreme caution must be used when moving an appliance containing hot oil or other hot liquids.
- 13 To disconnect, turn any control off. Then remove the plug from the wall outlet.
- 14 Do not use the appliance for purposes other than its intended use.
- 15 Make sure that the frying basket drawer is locked into the front of the fryer - both frying basket handle tabs must be fully inserted into the notches on the top of the pan.
- 16 Always make sure that the frying basket drawer is fully closed, with the frying basket handle locked securely in the pan, while the air fryer is in operation.

WARNING: The air fryer will not operate unless the frying basket drawer is fully closed.

CAUTION: After hot air frying, the frying basket, the pan, and the cooked foods are hot. Extreme caution must be used when handling the hot air fryer basket/pan.

FOR HOUSEHOLD USE ONLY

SAVE THESE INSTRUCTIONS

ADDITIONAL IMPORTANT SAFEGUARDS

CAUTION HOT SURFACES: This appliance generates heat and escaping steam during use. Proper precautions must be taken to prevent the risk of burns, fires, or other injury to persons or damage property.

CAUTION: This appliance is hot during operation and retains heat for some time after turning off. Always use oven mitts when handling hot materials and allow metal parts to cool before cleaning. Do not place anything on top of the appliance while it is operating or while it is hot.

- 1 All users of this appliance must read and understand this instruction manual before operating or cleaning this appliance.
- 2 The cord to this appliance should be plugged into a 120V AC electrical outlet only.
- 3 If this appliance begins to malfunction during use, immediately unplug the cord. Do not use or attempt to repair the malfunctioning appliance.
- 4 Do not leave this appliance unattended during use.
- 5 Do not immerse the power cord in any liquid. If the power cord to this appliance is damaged, it must be replaced by contacting Customer Service.
- 6 Keep the cord out of the reach of children and infants to avoid the risk of electric shock and choking.
- 7 Place the air fryer on a flat, heat-resistant work area.
- 8 Do not obstruct the air outlet or air inlets on the back and sides of the air fryer, with any objects. Avoid escaping steam from the air outlet during air frying.
- 9 Keep the fryer at least 4 in. (10.2 cm) away from walls or other objects during operation.
- 10 Always use the handle to open the frying basket drawer.
- 11 Do not replace the empty pan (without the frying basket) into the air fryer body. Check to make sure that the frying basket is locked in position in the pan.

WARNING: After air frying, make sure that you place the frying basket/pan on a flat, heat-resistant surface before pressing the basket release button.

WARNING: Under- or over-filling the frying basket may damage the air fryer and could result in serious personal injury.

- 12 Never move a hot air fryer or an air fryer containing hot food. Allow it to cool before moving.

Notes on the plug

This appliance has a polarized plug (one blade is wider than the other). To reduce the risk of electric shock, this plug fits in a polarized outlet only one way. If the plug does not fit fully into the outlet, reverse the plug. If it still does not fit, contact a qualified electrician. Do not modify the plug in any way.

Notes on the cord

The provided short power-supply cord should be used to reduce the risk resulting from becoming entangled in or tripping over a longer cord. An extension cord is not recommended for use with this product. Always plug directly into a wall outlet/receptacle.

Plasticizer warning

CAUTION: To prevent plasticizers from migrating to the finish of the counter top or table top or other furniture, place NON-PLASTIC coasters or place mats between the appliance and the finish of the counter top or table top. Failure to do so may cause the finish to darken. Permanent blemishes may occur or stains can appear.

Electric power

If the electrical circuit is overloaded with other appliances, your appliance may not operate properly. It should be operated on a separate electrical circuit from other appliances.

Overheating protection

The fryer has an overheating protection system. If the inner temperature control system is invalid, the overheating protection is automatically turned on, and the fryer is no longer ready to be used. Unplug the power cord, let the fryer cool down, and send it to an authorized service center for repair.

Automatic switch-off

When the timer display has counted down to 0, the fryer produces a bell sound and switches off automatically.

<p>Note: If the pan is pulled out during cooking, the fryer will be switched off automatically.</p>
--

Features

Package contents

- Air fryer
- User Guide

3.2 L Air Fryer (NS-AF32DBK9)

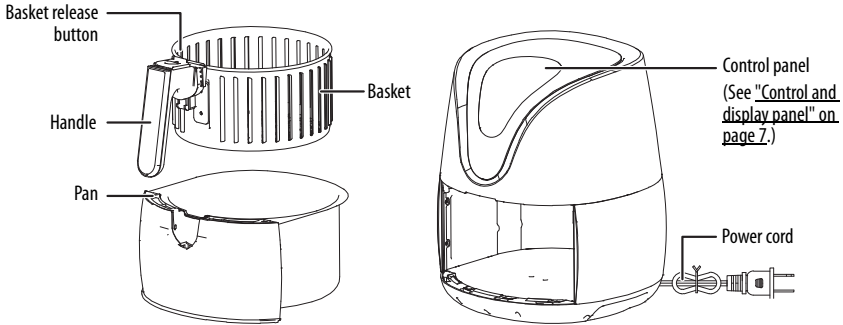

5.5 L Air Fryer (NS-AF55DBK9/NS-AF55DBK9-C)

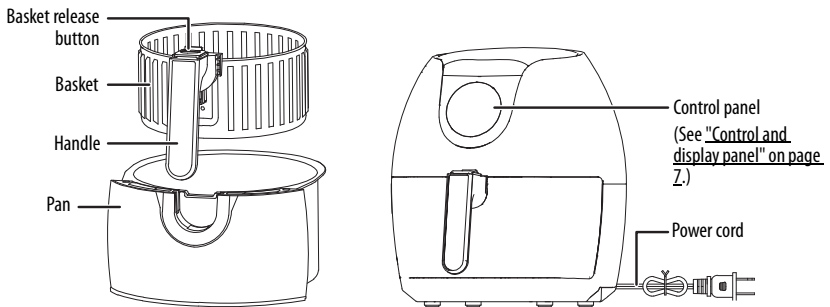

Control and display panel

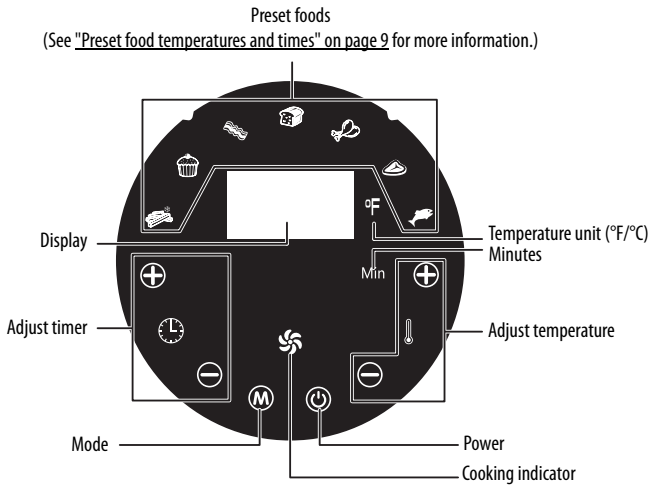













Before using your fryer for the first time



- 1 Remove all packaging material, stickers, and labels from the air fryer.
- 2 Clean the basket and pan with hot water, dish soap, and a non-abrasive sponge.
- 3 Wipe the inside and outside of the fryer with a moist cloth.

Using your air fryer

Caution:

- This air fryer works with hot air. Do not fill the pan with oil or any liquid.
- Do not place anything next to the air outlet on the back of the air fryer or on the air inlet on top of your air fryer.

- 1 Place the air fryer on a level, heat-resistant surface and plug the power cord into a wall outlet. All the icons light up for a second, then turn off. The  (power) icon stays red.
- 2 Pull the pan out of the air fryer, place your food in the basket, then replace the pan.
- 3 Press  (power) to turn on your air fryer.
- 4 Press  (mode) repeatedly to select the preset food item that you want to cook. You can select  french fries,  pastries,  bacon,  bread,  chicken,  steak, or  fish.
OR
If no preset is selected, use the adjust temperature and adjust timer buttons ( and ) to change the temperature and time, as needed.

Note: See "[Preset food temperatures and times](#)" on [page 9](#) for a list of each preset food item's default time and temperature. You can use the adjust temperature and adjust timer buttons ( and ) to change the preset temperature and time, as needed.



- 5 Press  (power) or wait 10 seconds. The air fryer starts and the timer counts down.

Note: You can pull out the pan at any time to check your food. The air fryer will pause automatically and resume after you slide the pan back into the air fryer.

- 6 If you are cooking a large amount of food, remove the pan and shake its contents halfway through the cook time. The air fryer and timer automatically continue after you replace the pan.

Notes:

- The fryer will not beep at the halfway point.
- Remove the basket to reduce the weight while shaking. See "[Removing the basket](#)" on [page 11](#) for more information.

- 7 When the air fryer beeps, the cook time is finished. Pull the pan out of the air fryer and place it on a heat-resistant surface.
OR
To turn off the fryer manually, press  (power). When the  (power) icon is red, pull out the pan.
- 8 Check if your food is done. If it's not finished, slide the pan back into the air fryer and start it again.



9 When finished, empty the basket into a bowl or onto a plate.







Tips:

- To remove small food, press the basket release button and lift the basket out of the pan.
- To remove large or fragile food, use a pair of tongs to lift the ingredients out of the basket.

10 Press  (power) to turn off your air fryer and unplug it from the wall outlet.

Preset food temperatures and times

This table shows the default temperature and times settings for items on the preset menu. You can use the adjust temperature and adjust timer buttons ( and ) to change the preset temperature and time, as needed.

FOOD PRESET	DEFAULT TEMPERATURE	DEFAULT TIME
 French fries	400°F (204°C)	13 minutes
 Pastries	400°F (204°C)	17 minutes
 Bacon	400°F (204°C)	8 minutes
 Bread	360°F (182°C)	23 minutes
 Chicken	360°F (182°C)	20 minutes
 Steak	360°F (182°C)	10 minutes
 Fish	360°F (182°C)	12 minutes

Food preparation temperatures and times

Because ingredients differ in origin, size, shape, and brand, you may need to adjust the cook times and temperatures in this table to suit your food.

FOOD	TEMP.	TIME	AMOUNT	NOTES
Potatoes & fries				
Thin frozen fries	390°F (199°C)	9-16 min.	11-25 oz. (300-700 g)	Shake halfway
Thick frozen fries	390°F (199°C)	11-20 min.	11-25 oz. (300-700 g)	Shake halfway
Homemade fries (8×8 mm)	390°F (199°C)	16-20 min.	11-28 oz. (300-800 g)	Add 1/2 tbsp oil Shake halfway
Homemade potato wedges	355°F (179°C)	18-22 min.	11-28 oz. (300-800 g)	Add 1/2 tbsp oil Shake halfway
Homemade potato cubes	355°F (179°C)	12-18 min.	9 oz. (250 g)	Add 1/2 tbsp oil Shake halfway
Rosti	355°F (179°C)	15-18 min.	18 oz. (500 g)	Shake halfway
Potato gratin	390°F (199°C)	15-18 min.	18 oz. (500 g)	Shake halfway
Meat & poultry				
Steak	360°F (182°C)	8-12 min.	6-18 oz. (100-500 g)	
Pork chops	360°F (182°C)	10-14 min.	6-18 oz. (100-500 g)	
Hamburger	360°F (182°C)	7-14 min.	6-18 oz. (100-500 g)	
Sausage roll	390°F (199°C)	13-15 min.	6-18 oz. (100-500 g)	
Drumsticks	360°F (182°C)	18-22 min.	6-18 oz. (100-500 g)	
Chicken breast	360°F (182°C)	10-15 min.	6-18 oz. (100-500 g)	
Bacon	400°F (204°C)	6-10 min.	11 oz. (300 g)	
Fish	360°F (182°C)	10-14 min.	18-28 oz. (500-800 g)	
Snacks				
Spring rolls	390°F (199°C)	8-10 min.	4-14 oz. (100-400 g)	Shake halfway
Frozen chicken nuggets	390°F (199°C)	6-10 min.	6-18 oz. (100-500 g)	Shake halfway
Frozen fish fingers	390°F (199°C)	6-10 min.	4-14 oz. (100-400 g)	
Frozen cheese curds	355°F (179°C)	8-10 min.	4-14 oz. (100-400 g)	
Stuffed vegetables	320°F (150°C)	10 min.	4-14 oz. (100-400 g)	
Baking				
Cake	320°F (150°C)	20-25 min.	11 oz. (300 g)	
Quiche	355°F (179°C)	20-22 min.	14 oz. (400 g)	
Muffins	390°F (199°C)	15-18 min.	11 oz. (300 g)	
Sweet snacks	320°F (150°C)	20 min.	14 oz. (400 g)	
Bread	360°F (182°C)	15-18 min.	11-18 oz. (300-500 g)	

Making homemade fries

- 1 Peel the potatoes and cut them into sticks.
- 2 Wash the potato sticks thoroughly and dry them with a paper towel.
- 3 Pour 1/2 tablespoon of olive oil in a bowl, put the sticks on top, and mix until the sticks are coated with oil.
- 4 Remove the sticks from the bowl and place them in the basket. Remove the sticks with your fingers or a kitchen utensil so that the excess oil stays in the bowl.
- 5 Cook the potato sticks in your air fryer, using the "[Food preparation temperatures and times](#)" on page 10.

Removing the basket

- 1 Pull the air fryer's handle out to slide the pan out.
- 2 Set the pan on a countertop.
- 3 Slide the release button cover forward to expose the red release button.
- 4 Press the release button and lift the basket out of the pan.
- 5 To replace the basket, place it in the pan and press down until the basket locks into place, then slide the safety tab back over the release button.

Cleaning your air fryer

Clean the air fryer after every use.

Note: Do not use abrasive cleaning materials to clean the pan or basket as they may damage the nonstick coating.

- 1 Unplug the air fryer from the wall outlet and wait for it to cool.

Note: Remove the pan to let the air fryer cool down more quickly.

- 2 Wipe the outside of the air fryer with a moist cloth.
- 3 Clean the pan and the basket with hot water, dish soap, and a non-abrasive sponge. Use a degreasing liquid to remove any remaining residue.

Tip: For tough-to-remove residue, fill the pan with hot water and dish soap, then place the basket in the pan and soak for approximately ten minutes.

- 4 Clean the inside of the air fryer with hot water and a non-abrasive sponge.
- 5 Clean the heating element with a cleaning brush to remove any food residue.

Storing your air fryer

- 1 Unplug the air fryer and let it cool down.
- 2 Make sure that all parts are clean and dry.
- 3 Put the air fryer in a clean and dry place.

Troubleshooting

PROBLEM	POSSIBLE CAUSE	SOLUTION
The air fryer does not work.	The fryer is not plugged in.	Plug the power cord into a grounded wall outlet.
	You have not set the temperature or timer.	Press  (power) to turn on the fryer, adjust settings, then press  (power) again to start.
	The pan is not put into the fryer properly.	The air fryer won't turn on unless the pan is fully inserted. Slide the pan into the fryer properly.
The food fried in the air fryer isn't done.	There's too much food in the air fryer.	Put smaller batches of ingredients in the basket. Smaller batches are fried more evenly.
	The set temperature is too low.	Increase the air fryer's temperature.
	The preparation time is too short.	Cook your food longer.
The ingredients are fried unevenly in the air fryer.	Certain types of ingredients need to be shaken halfway through the preparation time.	Shake foods that lie on top of or across each other (e.g. fries) halfway through the preparation time.
Fried snacks are not crispy when they come out of the air fryer.	You used a type of snacks meant to be prepared in a traditional deep fryer.	Use oven snacks or lightly brush some oil onto the snacks for a crispier result.
I cannot slide the pan into the fryer properly.	There is too much food in the basket.	Do not fill the basket beyond the MAX indication.
	The basket is not placed in the pan correctly.	Push the basket down into the pan until you hear a click.
White smoke comes out of the air fryer.	You are preparing greasy ingredients.	When you fry greasy ingredients in the air fryer, a large amount of oil will leak into the pan. The oil produces white smoke and the pan may heat up more than usual. This does not affect the fryer or the end result.
	The pan still has grease residue from a previous use.	White smoke is caused by grease heating up in the pan. Make sure that you clean the pan properly after each use.

PROBLEM	POSSIBLE CAUSE	SOLUTION
Fresh fries are fried unevenly in the air fryer.	You did not use the right potato type.	Use fresh potatoes to make sure that they stay firm during frying.
	You did not rinse the fries properly before you fried them.	Rinse the fries properly to remove starch from the outside of the sticks.
Fresh fries are not crispy when they come out of the air fryer.	The crispiness of the fries depends on the amount of oil and water in the fries.	Make sure that you dry the potato sticks properly before you add the oil.
		Cut the potato sticks smaller for a crispier result.
		Add slightly more oil for a crispier result.

Specifications

3.2 L Air Fryer (NS-AF32DBK9)

Dimensions (H × W × D)	12.8 × 11.1 × 13.7 in. (32.6 × 28.1 × 34.8 cm)
Weight	9.9 lbs. (4.5 kg)
Power requirements	1500W
Current	120V, 60Hz
Operating temperature	180 ~ 400°F (82.2 ~ 204.4°C)
Cord length	3.3 ft. (1.0 m)

5.5L Air Fryer (NS-AF55DBK9/NS-AF55DBK9-C)

Dimensions (H × W × D)	15.3 × 12.8 × 15.3 in. (38.8 × 32.5 × 38.9 cm)
Weight	12.3 lbs. (5.6 kg)
Power requirements	1700W
Current	120V, 60Hz
Operating temperature	180 ~ 400°F (82.2 ~ 204.4°C)
Cord length	3.3 ft. (1.0 m)

ONE-YEAR LIMITED WARRANTY

Definitions:

The Distributor* of Insignia branded products warrants to you, the original purchaser of this new Insignia-branded product ("Product"), that the Product shall be free of defects in the original manufacturer of the material or workmanship for a period of one (1) year from the date of your purchase of the Product ("Warranty Period").

For this warranty to apply, your Product must be purchased in the United States or Canada from a Best Buy branded retail store or online at www.bestbuy.com or www.bestbuy.ca and is packaged with this warranty statement.

How long does the coverage last?

The Warranty Period lasts for 1 year (365 days) from the date you purchased the Product. Your purchase date is printed on the receipt you received with the Product.

What does this warranty cover?

During the Warranty Period, if the original manufacture of the material or workmanship of the Product is determined to be defective by an authorized Insignia repair center or store personnel, Insignia will (at its sole option): (1) repair the Product with new or rebuilt parts; or (2) replace the Product at no charge with new or rebuilt comparable products or parts. Products and parts replaced under this warranty become the property of Insignia and are not returned to you. If service of Products or parts are required after the Warranty Period expires, you must pay all labor and parts charges. This warranty lasts as long as you own your Insignia Product during the Warranty Period. Warranty coverage terminates if you sell or otherwise transfer the Product.

How to obtain warranty service?

If you purchased the Product at a Best Buy retail store location or from a Best Buy online website (www.bestbuy.com or www.bestbuy.ca), please take your original receipt and the Product to any Best Buy store. Make sure that you place the Product in its original packaging or packaging that provides the same amount of protection as the original packaging.

To obtain warranty service, in the United States call 1-888-BESTBUY or in Canada call 1-866-BESTBUY. Call agents may diagnose and correct the issue over the phone.

Where is the warranty valid?

This warranty is valid only in the United States and Canada at Best Buy branded retail stores or websites to the original purchaser of the product in the county where the original purchase was made.

What does the warranty not cover?

This warranty does not cover:

- Customer instruction/education
- Installation
- Set up adjustments
- Cosmetic damage
- Damage due to weather, lightning, and other acts of God, such as power surges
- Accidental damage
- Misuse
- Abuse
- Negligence
- Commercial purposes/use, including but not limited to use in a place of business or in communal areas of a multiple dwelling condominium or apartment complex, or otherwise used in a place of other than a private home.
- Modification of any part of the Product, including the antenna
- Display panel damaged by static (non-moving) images applied for lengthy periods (burn-in).
- Damage due to incorrect operation or maintenance

- Connection to an incorrect voltage or power supply
- Attempted repair by any person not authorized by Insignia to service the Product
- Products sold "as is" or "with all faults"
- Consumables, including but not limited to batteries (i.e. AA, AAA, C, etc.)
- Products where the factory applied serial number has been altered or removed
- Loss or Theft of this product or any part of the product
- Display panels containing up to three (3) pixel failures (dots that are dark or incorrectly illuminated) grouped in an area smaller than one tenth (1/10) of the display size or up to five (5) pixel failures throughout the display. (Pixel based displays may contain a limited number of pixels that may not function normally.)
- Failures or Damage caused by any contact including but not limited to liquids, gels or pastes.

REPAIR REPLACEMENT AS PROVIDED UNDER THIS WARRANTY IS YOUR EXCLUSIVE REMEDY FOR BREACH OF WARRANTY. INSIGNIA SHALL NOT BE LIABLE FOR ANY INCIDENTAL OR CONSEQUENTIAL DAMAGES FOR THE BREACH OF ANY EXPRESS OR IMPLIED WARRANTY ON THIS PRODUCT, INCLUDING, BUT NOT LIMITED TO, LOST DATA, LOSS OF USE OF YOUR PRODUCT, LOST BUSINESS OR LOST PROFITS. INSIGNIA PRODUCTS MAKES NO OTHER EXPRESS WARRANTIES WITH RESPECT TO THE PRODUCT, ALL EXPRESS AND IMPLIED WARRANTIES FOR THE PRODUCT, INCLUDING BUT NOT LIMITED TO ANY IMPLIED WARRANTIES OF AND CONDITIONS OF MERCHANTABILITY AND FITNESS FOR A PARTICULAR PURPOSE, ARE LIMITED IN DURATION TO THE WARRANTY PERIOD SET FORTH ABOVE AND NO WARRANTIES, WHETHER EXPRESS OR IMPLIED, WILL APPLY AFTER THE WARRANTY PERIOD. SOME STATES, PROVINCES AND JURISDICTIONS DO NOT ALLOW LIMITATIONS ON HOW LONG AN IMPLIED WARRANTY LASTS, SO THE ABOVE LIMITATION MAY NOT APPLY TO YOU. THIS WARRANTY GIVES YOU SPECIFIC LEGAL RIGHTS, AND YOU MAY ALSO HAVE OTHER RIGHTS, WHICH VARY FROM STATE TO STATE OR PROVINCE TO PROVINCE.

Contact Insignia:

1-877-467-4289

www.insigniaproducts.com

INSIGNIA is a trademark of Best Buy and its affiliated companies.

*Distributed by Best Buy Purchasing, LLC

7601 Penn Ave South, Richfield, MN 55423 U.S.A.

©2018 Best Buy. All rights reserved.

Made in China

INSIGNIA™

www.insigniaproducts.com

1-877-467-4289 (U.S. and Canada) or 01-800-926-3000 (Mexico)

INSIGNIA is a trademark of Best Buy and its affiliated companies.

Distributed by Best Buy Purchasing, LLC

7601 Penn Ave South, Richfield, MN 55423 U.S.A.

©2018 Best Buy. All rights reserved.

Made in China

V1 ENGLISH
18-0284