

Installation Instructions

Bathtub Faucet Types:

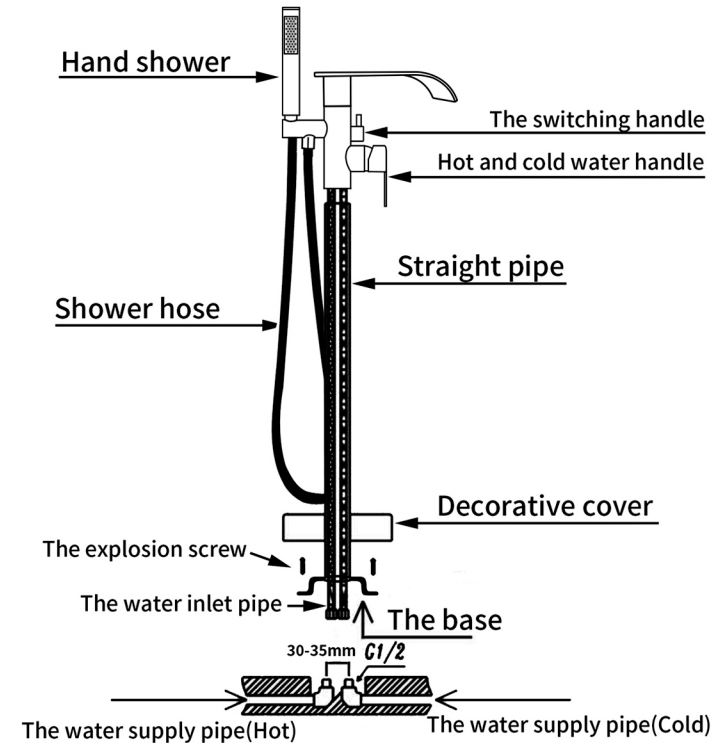
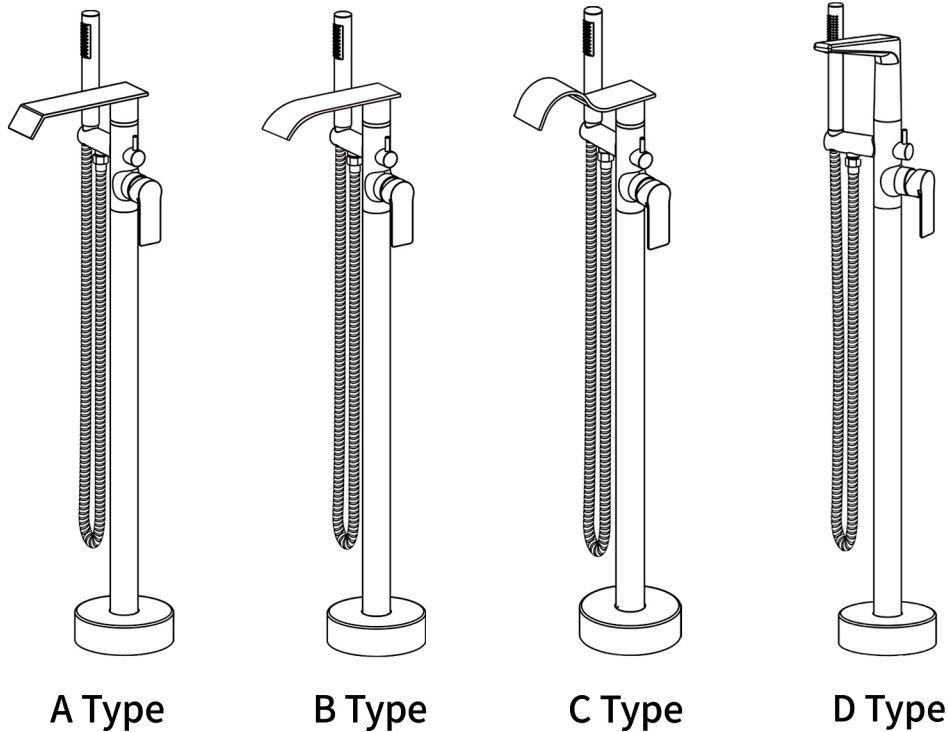

Presentation:

- 1.The switching handle: Switch water to faucet spout or hand shower: turn left for faucet spout; Turn right for hand shower
- 2.Hot and cold water handle: Pushing the handle to right turns the water on
Turn the handle forward for hot water ;Turn the handle backward for cold water

Caution:

- 1.Before installation, all water lines must be flushed at least 60 seconds to remove any foreign material so that the foreign material will not block the areator or damage the cartridge
- 2.Use water and soft cloth to clean the faucet
- 3.Can use a mild liquid detergent for cleaning, do not use abrasive detergent that may scratch or dull the surface.

Style may vary by model, but the installation ways are the same

Installation Steps:

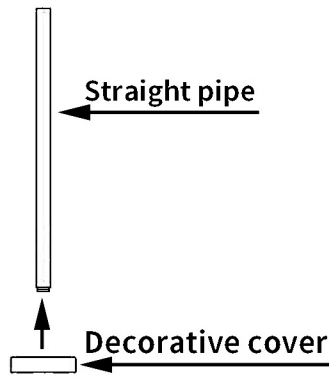

1. Put the decorative cover over the straight pipe

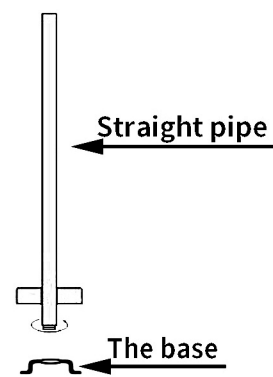

2. Screw the straight pipe to the base

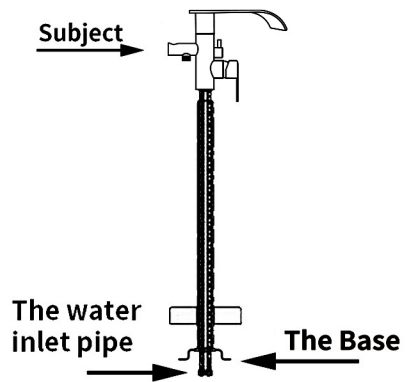

3. Screw and hand tighten the water inlet pipe to the water inlets of the subject (DO NOT USE SPANNER TO TIGHTEN AS IT CAN DAMAGF THE O-RING) Make sure the water inlet pipe were screwed into the correct inlets for hot water and cold water.

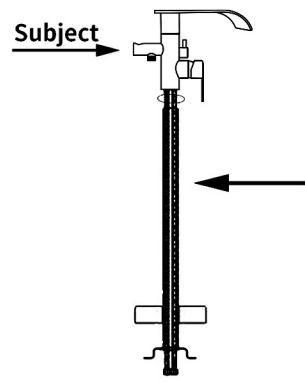

4. Screw the subject into the straight pipe.

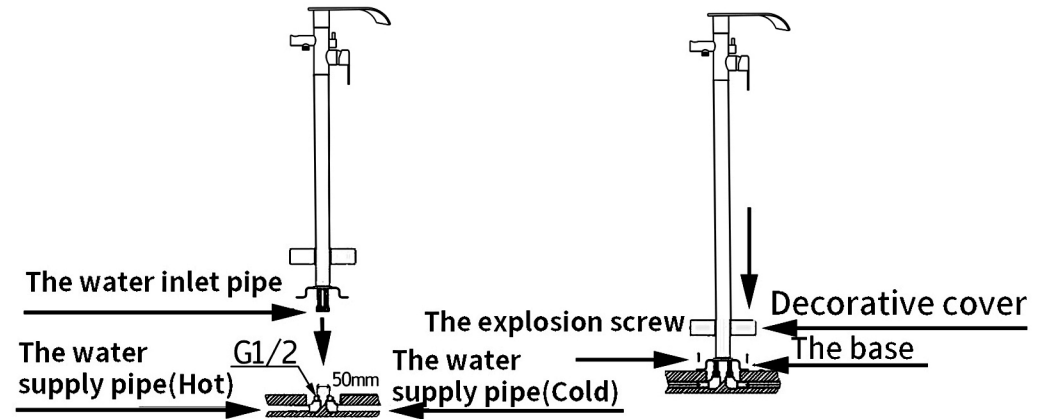

5. Connect another side of the water inlet pipe to the water supply pipe. Make sure they were screwed into the correct outlets for hot water and cold water.

6. Use the explosion screws to fix the base on the ground, and put the decorative cover over the base

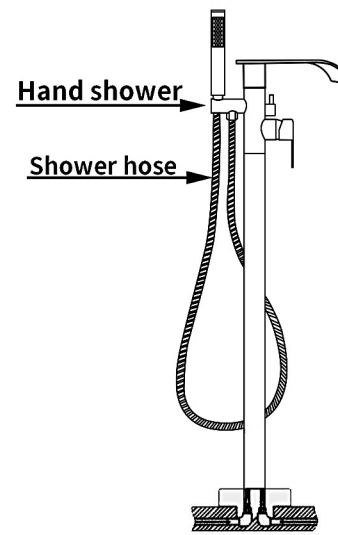

7. Connect the shower hose and hand shower

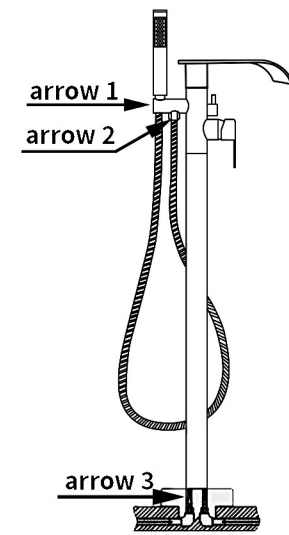

8. Inspect for leaks at arrows.