

 Westinghouse |  XumoTV

# Quick Start Guide



For customer support,  
scan the QR code.  
Para atención al cliente,  
escanee el código QR.  
Pour le support client,  
scannez le code QR.

Tools you will need:



Questions? Call (800) 701-0680 or  
visit [westinghouse.com/support](https://westinghouse.com/support)

¿Tiene preguntas? Llame al (800) 701-0680 o visite [westinghouse.com/support](https://westinghouse.com/support)  
Des questions? Téléphoner au (800) 701-0680 ou visitez [westinghouse.com/support](https://westinghouse.com/support)

 Westinghouse |  XumoTV



## IMPORTANT SAFETY INSTRUCTIONS

- **Read these instructions** – All the safety and operating instructions should be read before this product is operated.
- **Keep these instructions** – The safety and operating instructions should be retained for future reference.
- **Heed all warnings** – All warnings on the appliance and in the operating instructions should be adhered to.
- **Follow all instructions** – All operating and use instructions should be followed.
- **Do not use this apparatus near water** – The appliance should not be used near water or moisture - for example, in a wet basement or near a swimming pool and the like.
- **Clean only with a dry cloth.**
- **DO NOT:**
  - Block any ventilation openings. Always install in accordance with the manufacturer's instructions.
  - Install near any heat sources such as radiators, heat registers, stoves, or other apparatus (including amplifiers) that produce heat.
  - Use a polarized plug for this television. A polarized plug has two blades with one wider than the other. A grounding-type plug has two blades and a third grounding prong. The wide blade (or third prong) is provided for your safety. For the provided plug does not fit into your outlet, consult an electrician for a replacement of the obsolete outlet.
- Protect the power cord from being walked on or pinched, particularly at plugs, convenience receptacles, and the point where they exit from the apparatus.
- Only use attachments/accessories specified by the manufacturer.
- Use only with the cart, stand, tripod, bracket or table specified by the manufacturer, or sold with the apparatus. When a cart is used, use caution when moving the cart apparatus combination to avoid injury from tip-over.



- Unplug this apparatus during lightning storms or when unused for long periods of time.
- Refer all servicing to qualify service personnel. Servicing is required when the apparatus has been damaged in any way, such as the power-supply cord or plug is damaged, liquid has been spilled or objects have fallen into the apparatus, the apparatus has been exposed to rain or moisture, does not operate normally, or has been dropped.

- Keep unit in a well ventilated environment.

- **WARNING:**

- To reduce the risk of fire or electric shock, do not expose this apparatus to rain or moisture. The apparatus should not be exposed to dripping or splashing. Objects filled with liquids, such as vases should not be placed on apparatus.
- The batteries shall not be exposed to excessive heat such as sunshine, fire or the like.
- When a power plug or an appliance coupler is used as a disconnecting device, the disconnecting device should be easy to operate.
- To reduce the risk of electric shock, do not remove cover (or back) as there are no user-serviceable parts inside. Refer servicing to qualified personnel.



This symbol is intended to alert the user to the presence of non-insulated "dangerous voltage" within the product's enclosure that may be of sufficient magnitude to constitute a risk of electric shock.



This symbol is intended to alert the user to the presence of important operating and maintenance instructions in the literature accompanying the appliance.



This equipment is a Class II or double insulated electrical appliance. It has been designed in such a way that it does not require a safety connection to electrical earth.



This product contains electrical or electronic materials. The presence of these materials may, if not disposed of properly, have potential adverse effects on the environment and human health. Presence of this label on the product means it should be disposed of as unsorted waste and must be collected separately. As a consumer, you are responsible for ensuring that this product is disposed of properly. Please visit our website Westinghouse Recycling for additional recycling information.



**Supplier's Declaration of Conformity  
47 CFR § 2.1077 Compliance Information**

Responsible Party – US contact information

Company: Westinghouse Electronics.

Address: 6255 Providence Way,

Eastvale,

CA 92880

Tel: (800)-701-0680

FCC Compliance Statement (Products subject to Part 15)

This device complies with Part 15 of the FCC Rules. Operation is subject to the following two conditions:

(1) This device may not cause harmful interference, and (2) This device must accept any interference received, including interference that may cause undesired operation.



**FCC STATEMENT**

This device complies with Part 15 of the FCC Rules. Operation is subject to the following two conditions:

(1) This device may not cause harmful interference, and

(2) This device must accept any interference received, including interference that may cause undesired operation. Changes or not expressly approved by the party responsible for compliance could void the user's authority to operate the equipment.

NOTE: This equipment has been tested and found to comply with the limits for a Class B digital device, pursuant to Part 15 of the FCC Rules. These limits are designed to provide reasonable protection against harmful interference in a residential installation. This equipment generates uses and can radiate radio frequency energy and, if not installed and used in accordance with the instructions, may cause harmful interference to radio communications.

However, there is no guarantee that interference will not occur in a particular installation. If this equipment does cause harmful interference to radio or television reception, which can be determined by turning the equipment off and on, the user is encouraged to try to correct the interference by one or more of the following measures:

(1) Reorient or relocate the receiving antenna.

(2) Increase the separation between the equipment and receiver.

(3) Connect the equipment into an outlet on a circuit different from that to which the receiver is connected.

(4) Consult the dealer or an experienced radio/TV technician for help.

**FCC Radiation Exposure Statement**

This equipment complies with FCC radiation exposure limits set forth for an uncontrolled environment.

This equipment should be installed and operated with minimum distance 20cm between the radiator & your body.

## TABLE OF CONTENTS

PACKAGE CONTENT	1
INSTALLING THE TV STAND	2
LOCATION OF CONNECTORS	3
CONNECTING DEVICES TO YOUR TV	4
SETTING UP YOUR TV	5
CONNECT AN ANTENNA (OPTIONAL)	7
REMOTE CONTROL	8

**This Quick Start Guide is provided so that you can properly set up your new TV.**

**Figures and illustrations in this Operation Manual are provided for reference only and may differ from actual product appearance. Product design and specifications may be changed without notice.**

## PACKAGE CONTENT

\*The picture is for reference only, subject to the actual product.

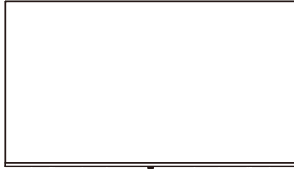

Westinghouse Xumo TV x 1pcs



Quick Start Guide x 1pcs



Remote Control x 1pcs



Batteries for Remote Control  
(Size AAA) x 2pcs

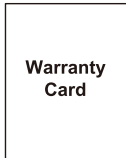

Warranty Card x 1pcs



Screws for TV Stand x 4pcs



Stands x 2pcs

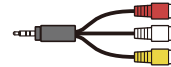

Mini AV cable x 1pcs

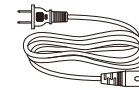

Power Cable  
(43"/55")



Tech Support Card x 1pcs

What you need (not included):

- Phillips screw driver
- Wireless router (needed for streaming)
- Internet connection (needed for streaming)
- Computer, tablet, or smart phone (needed for setup)

For additional support, please refer to User Manual and

Westinghouse Customer Support at

<https://tv.xumo.com/support>

<https://westinghouse.com/support>

Key things to know: A paid subscription or other payments may be required for some streaming channel content.

Channel availability subject to change and varies by country.

## INSTALLING THE TV STAND

It is recommended two people handle TV stand installation. To prevent scratch or damage to the TV screen, place the TV on a soft, flat surface.

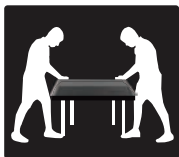

Attach the stands to the bottom of the TV by inserting the stand into slots on the TV. Secure the stands to the TV with the supplied screws.

To attach the left and right legs that form the stand:

1. Place the legs into the bottom slots of the TV, then insert and tighten the screws (found in the accessories bag) in the circled areas with the screwdriver (not provided)

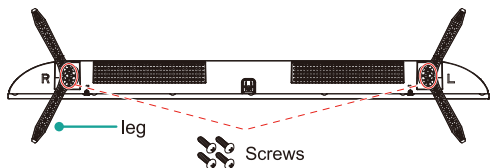

2. After securing the stand, place the TV on a stable surface. The TV is ready for use now.

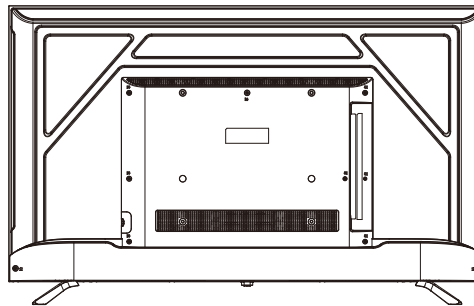

Note: TV can also be wall mounted. Wall mount sold separately.

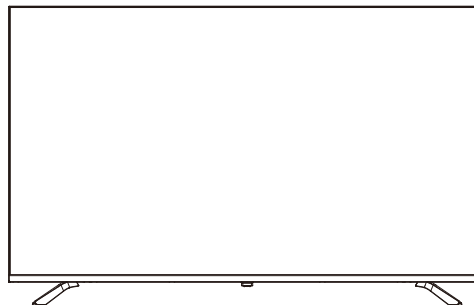

\*The picture is for reference only, subject to the actual product.

# LOCATION OF CONNECTORS

TV Back View

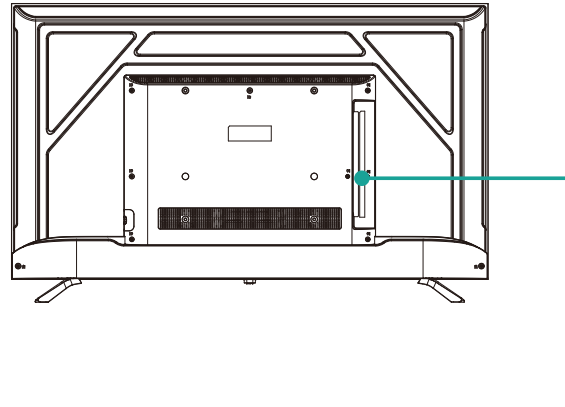

TV Side View

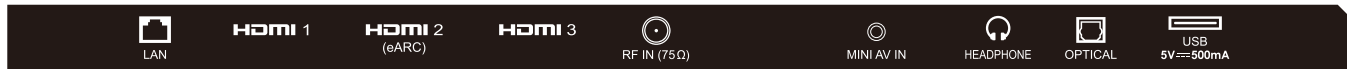



## CONNECTING DEVICES TO YOUR TV

Westinghouse recommends using the best-quality video connection for your cable box, satellite receiver, Blu-ray, DVD player, game box or any other device starting with **HDMI**®.



### CAUTION

Disconnect the power cord before connecting device

#### CONNECTION TO HDMI INPUT

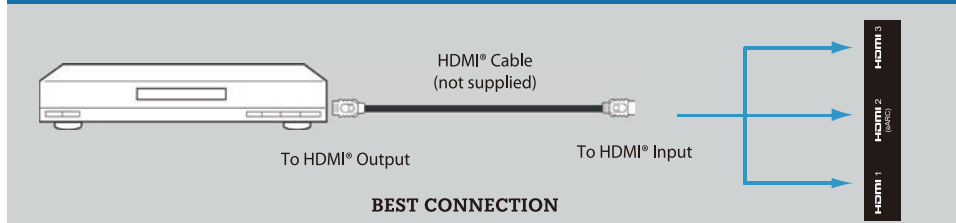

#### CONNECTION TO AUDIO/VIDEO INPUT

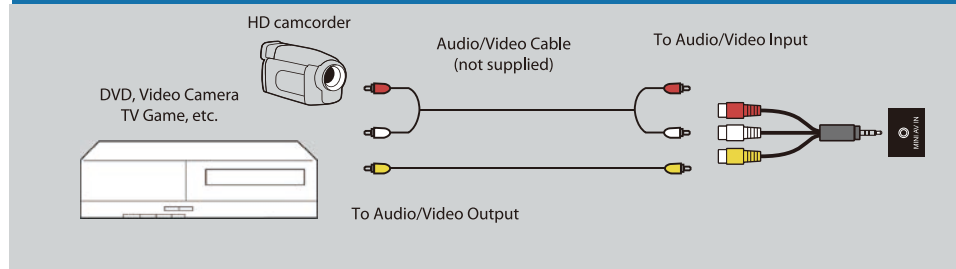

HDMI is a trademark of HDMI Licensing LLC in the United States and other countries.

## SETTING UP YOUR TV

### 1. Plug in and turn on TV

Connect your power cord to the TV, then plug it into the wall outlet. Press the power button on your TV remote control.

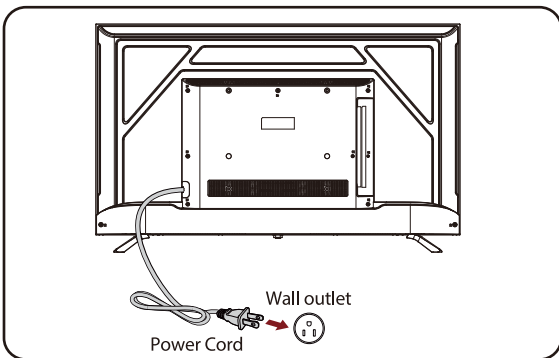



### 2. How to pair your remote to Xumo TV during setup

Power your TV remote by inserting the included batteries, carefully matching the (+) and (-) indicated inside the battery compartment.

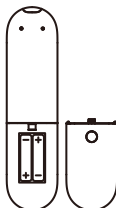
Before using your remote, you'll need to pair it with your TV. If you put batteries in your remote within 15 minutes of plugging in your TV for the first time, your remote will automatically pair to your TV. Should you experience any issues, proceed with the following instructions:





### How to pair your remote to Xumo TV after setup

1. Press and hold the  button.
2. If that doesn't work, press and hold the  and  buttons for 2 seconds.

### How to pair your remote to a sound system

1. Press the  button.
2. Select  > **Remote** > **Pair your remote and sound system**.
3. Follow the on-screen instructions.

### How to reset your remote

1. Press and hold the  and  buttons for 5 seconds.
2. With your remote control pointed towards your TV, try pressing the  button then other keys to make sure your remote is working properly.

Note: Voice control will not work until you pair your remote. Voice commands only work when your TV is connected to the internet.

TIP: Always replace dead batteries with two brand new batteries from the same manufacturer. Never use damaged batteries.

If your remote gets warm/hot during use, discontinue use and contact customer support immediately.

## SETTING UP YOUR TV

### 3. Follow the on-screen instructions

When your TV powers on, follow the easy on-screen instructions for setup.

Connecting your TV to the internet gives you access to all the things that make your TV smart, including apps, voice controls, and more. Your TV will automatically detect wireless networks in your area, so have your network name and password handy. If you aren't ready to connect to a wireless network, you can still use it as a regular TV and can connect it later within Settings.

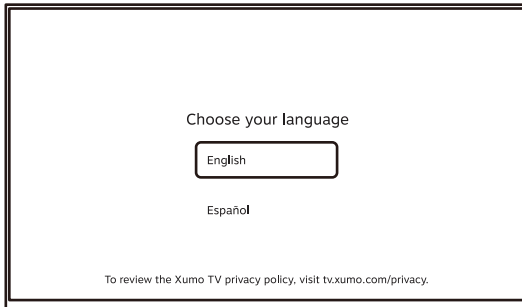

### 4. Activate your smart TV

To activate your TV you'll need a computer, smartphone or tablet. Once you see the activation code on the TV screen, you can visit [xumo.com/activate](https://xumo.com/activate) (or simply scan the QR code on-screen with your smart device camera) and follow the on-screen instructions to complete registration. You'll be directed to the home screen when setup is complete.

You may also create a Xumo account with a payment method if you would like to make purchases on your TV. Note: Creating a Xumo account and adding payment details is optional and not required to use your TV.

A paid subscription or other payments may be required for some streaming channels. Channel availability subject to change and varies by country or region.

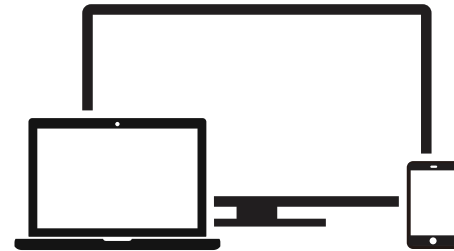

## CONNECT AN ANTENNA (OPTIONAL)

Check to ensure that you have selected the right cables for the ports and that they are connected securely. Loose connections can affect the quality of the picture image and color. (Cables and external equipment not included.)

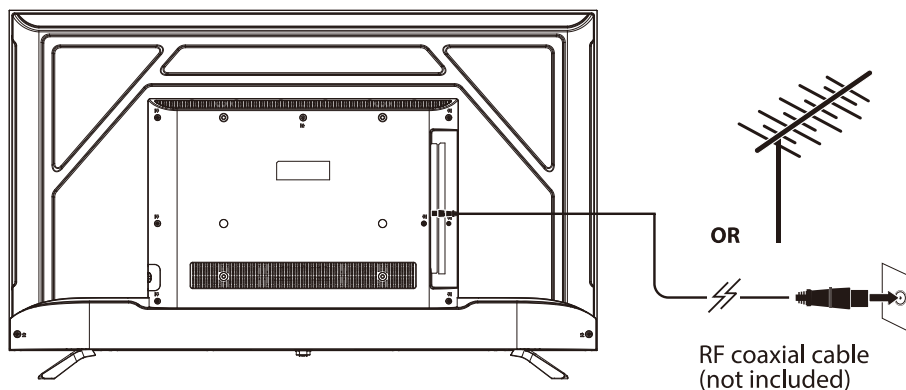

Note:  
Aerial connections : F connector.  
Input impedance :  $75\Omega$  unbalanced.

With the built-in tuner, you can connect your TV to an antenna and enjoy over-the-air entertainment.

1. To connect your TV to an antenna, connect a coax cable (not included) into your TV's **ANT** port and the other end into your device.
2. Turn your TV on and press the home button on your remote.
3. Select the **Antenna** tile, or open **Settings > Antenna and inputs > Antenna > Scan for channels**.
4. Follow the on-screen instructions.

## REMOTE CONTROL

The Xumo TV remote should feel right at home in your hand. It was designed to be incredibly intuitive for watching TV and navigating on-screen menus.

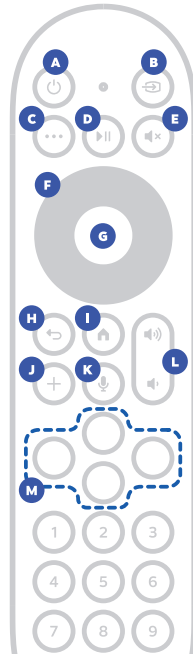

- A Power:** Turn your TV on/off
- B Input:** View and change device input
- C Quick Access:** Access quick settings and search
- D Play/Pause:** Pause or resume content
- E Mute:** Silence audio
- F Navigation pad:** Move up, down, left or right
- G OK:** Select an item
- H Back:** Return to the previous screen
- I Home:** Return to the home screen or wake your device
- J Add:** Add to or remove from My list
- K Voice Control:** Press and hold while saying a voice command to navigate and find content
- L Volume:** Adjust volume level
- M Apps:** Launch apps with dedicated shortcuts



**Register your products online:** <https://westinghouse.com/register>

Enjoy these benefits by registering your product online today!

- Up-to-date product information
- Exciting promotional offers
- Industry news

Westinghouse Electronics has a comprehensive online privacy policy designed to protect our online visitor's information. Please visit <https://westinghouse.com/pages/privacy-policy-2> for our complete Online Privacy Policy.

**Need help? Contact us at: (800) 701-0680**

or go to <https://westinghouse.com/support>

To download the complete Xumo TV User Manual and explore the latest information, visit <https://tv.xumo.com/support>

## WARNING

A television set may fall, causing serious personal injury or death. Many injuries, particularly to children, can be avoided by taking simple precautions such as:

- ALWAYS use cabinets or stands or mounting methods recommended by the manufacturer of the television set.
- ALWAYS use furniture that can safely support the television set.
- ALWAYS ensure the television set is not overhanging the edge of the supporting furniture.
- ALWAYS educate children about the dangers of climbing on furniture to reach the television set or its controls.
- ALWAYS route cords and cables connected to your television so they cannot be tripped over, pulled or grabbed.
- NEVER place a television set in an unstable location.
- NEVER place the television set on tall furniture (for example, cupboards or bookcases) without anchoring both the furniture and the television set to a suitable support.
- NEVER place the television set on cloth or other materials that may be located between the television set and supporting furniture.
- NEVER place items that might tempt children to climb, such as toys and remote controls, on the top of the television or furniture on which the television is placed.

If the existing television set is going to be retained and relocated, the same considerations as above should be applied.

The TV is provided with mounting holes for a VESA approved wall mounting bracket (not included). Mount the VESA bracket using isometric threaded screws 43inch: 4\*M4\*10; 50~55inch: 4\*M6\*28 (not included).



The terms HDMI, HDMI High-Definition Multimedia Interface, HDMI Trade dress and the HDMI Logo are trademarks or registered trademarks of HDMI Licensing Administrator, Inc.



Dolby, Dolby Vision, Dolby Audio, and the double-D symbol are trademarks of Dolby Laboratories Licensing Corporation. Manufactured under license from Dolby Laboratories. Confidential unpublished works. Copyright © 1992–2024 Dolby Laboratories. All rights reserved.



The Bluetooth<sup>®</sup> word mark and logos are registered trademarks owned by Bluetooth SIG, Inc. and any use of such marks by Westinghouse is under license. Other trademarks and trade names are those of their respective owners.



Operating ambient temperature: 0 - 35°C,  
Storage and transportation ambient temperature: -10 - 50°C,  
altitude not higher than 5000m (air pressure not less than 54kPa),

**WARNING:**

- replacement of a battery with an incorrect type may defeat a safeguard;
- disposal of a battery into fire or a hot oven, or mechanically crushing or cutting of a battery, may result in an explosion;
- leaving a battery in an extremely high temperature surrounding environment, such as sunshine, fire, or hot surface may result in an explosion or the leakage of flammable liquid or gas;
- a battery subjected to extremely low air pressure may result in an explosion or the leakage of flammable liquid or gas.

**CAUTION**

Risk of fire or explosion if the battery is replaced by an incorrect type!