

BougeRV

USER MANUAL

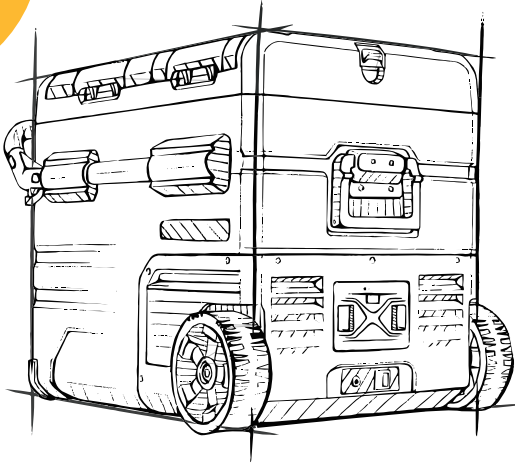

Dual Door Series

Capacity
35/45/55L

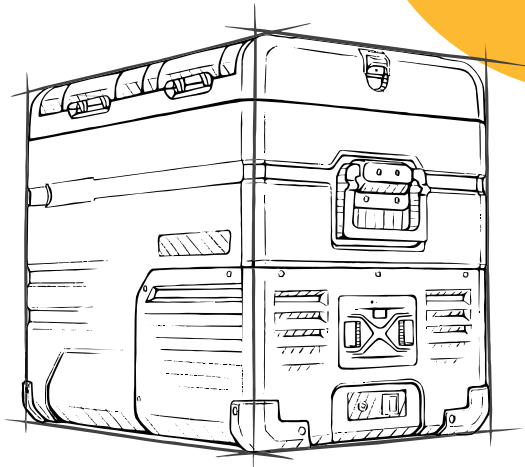

Please read this manual carefully before use and keep it properly for further reference.

Contents

1 Package Contents	Page1
2 Safety Instructions	Page2
3 Preparing Before Use	Page3
4 Product Introduction	Page3
4.1 Product Features	Page3
4.2 Product Size	Page3
4.3 Product Structure	Page6
4.4 Reverse Door Opening Direction	Page8
5 Operation Instruction	Page9
5.1 Power Supply	Page9
5.2 Display Screen Initialization	Page9
5.3 Turn On/Off	Page9
5.4 Temperature Setting	Page9
5.5 MAX/ECO Mode Switching	Page10
5.6 Temperature Unit Switch	Page10
5.7 Car Battery Protection Setting H/M/L	Page11
6 Car Battery Protection(H/M/L) Voltage Reference	Page11
7 Error Code Problems and Troubleshooting	Page14
8 Cleaning and Storage	Page15
9 FAQ	Page16
10 Warranty and Maintenance	Page18
11 Specification	Page19
12 APP Control	Page20

1 Package Contents

Car Refrigerator

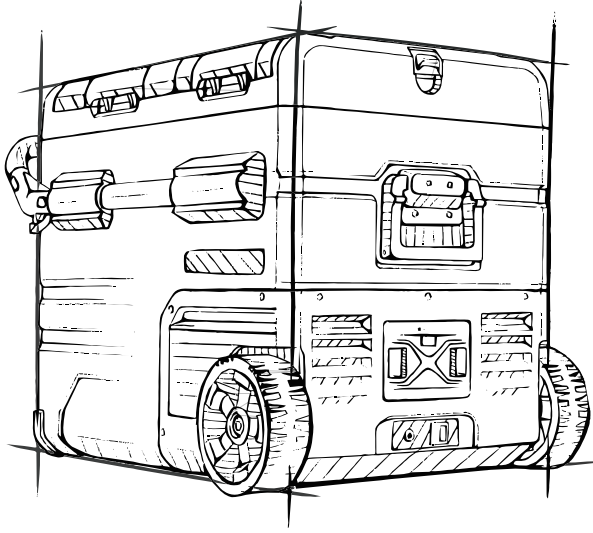

User Manual

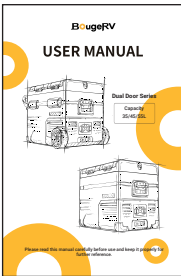

12/24V DC
Power Cord

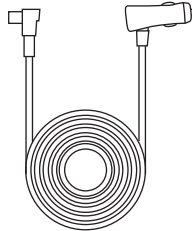

110/220V AC
Power Adapter

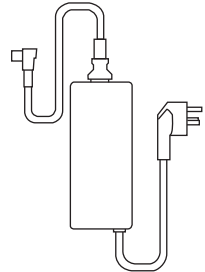

2 Safety Instructions



WARNING! Failure to obey these warnings could result in the malfunction of your device and possible injury to yourself and other users.

- Do not operate the device if it is visibly damaged.
- Do not block the gaps of the device with small items like pins, wires, etc.
- Do not expose the device to rain or soak it in water.
- Do not place the device near naked flames or other heat sources (heaters, direct sunlight, gas ovens etc.)
- Do not store explosive substances like spray cans with flammable propellants in the device.
- Before starting the device, ensure that the power supply line and the plug are dry.
- Check if the voltage specification on the nameplate matches the power supply voltage specification.
- Before starting the device, it must be left horizontal for more than 12 hours.
- Make sure that the device stays horizontal when it is running. The tilt angle must be less than 5° for a long time running and less than 45° for short time running.
- The refrigerator must be well-ventilated for heat dissipation and make sure to keep some space around it (Back Space 200mm, Side Space 100mm).
- The device may only be repaired by Qualified personnel. Improper repairs can lead to safety hazards. If the power cable is damaged, it must be replaced by the manufacturer, customer service, or a similarly Qualified person in order to prevent safety hazards.



NOTICE!

- The device can be used by children aged eight years and over, as well as by persons with reduced physical, sensory or mental abilities or lack of experience and knowledge. However, they must be supervised during use or they must have been adequately taught how to use the fridge safely and have been made aware of the risks involved before using it.
- Children must be supervised to ensure that they do not play with the device.
- Disconnect the device or switch it off when you turn off the engine. Otherwise, you may discharge the battery.



CAUTION!

- Food is suggested to be stored in its original packaging or in suitable containers.
- Set a suitable temperature for food stored in the device. Refer to the recommended temperature for common food on Page 11.

3 Preparing Before Use

1. Unpackage and take out the accessories, and let the device stand for 12 hours.
2. Before using it for the first time, clean the inside and outside of the car refrigerator with a damp cloth and wait until it gets dry.
3. Place your refrigerator in a proper position which depends on your use scenario (car, truck, RV, camper, Van, Jeep, SUV, boat, home, etc.)
4. According to your use scenario, please choose the right power cord (AC cord or DC cord) for the right power supply. Please read the next part carefully for the details.

4 Product Introduction

4.1 Product Features

- High-efficiency DC compressor and conversion module.
- CFC free and great heat insulation.
- Fast cooling to -20°C / -4°F (based on 25°C / 77°F room temperature).
- LCD digital display for temperature setting.
- Dual compartments with individual temperature control.
- Three stage battery protection system prevents vehicle run out of battery.

4.2 Product Size

Capacity: 37Quart / 35L

Dimensions:

With handle: 28*18.1*17.4 in

(71.1*46*44.1cm)

Without handle: 23.6*15.7*17.4 in

(60*40*44.1cm)

Big zone: 12.2*10.6*13.5 in

(30.9*26.9*34.3cm)

Small zone: 12.2*7.9*6.6 in

(30.9*20*16.7cm)

N.W.: 40.7lb(18.44kg)

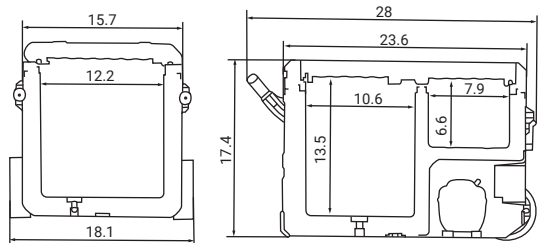

Capacity: 48Quart / 45L

Dimensions:

With handle: 28*18.1*19.9 in
(71.1*46*50.6cm)

Without handle: 23.6*15.7*19.9 in
(60*40*50.6cm)

Big zone: 12.2*10.6*16.1 in
(30.9*26.9*40.8cm)

Small zone: 12.2*7.9*9.1 in
(30.9*20*23.2cm)

N.W.: 42.3lb(19.19kg)

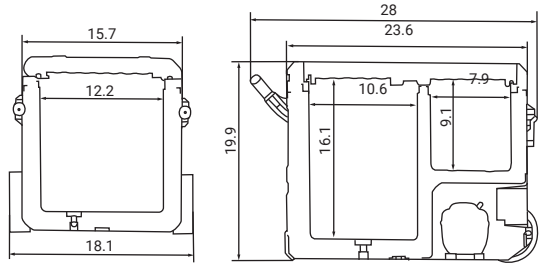

Capacity: 59Quart / 55L

Dimensions:

With handle: 28*18.1*22.5 in
(71.1*46*57.1cm)

Without handle: 23.6*15.7*19.9 in
(60*40*57.1cm)

Big zone: 12.2*10.6*18.6 in
(30.9*26.9*47.3cm)

Small zone: 12.2*7.9*11.7 in
(30.9*20*23.2cm)

N.W.: 43.2lb(19.61kg)

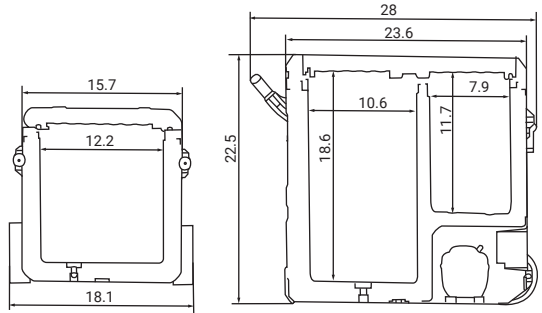

Capacity: 37Quart / 35L

Dimensions:

With handle: 25.5*15.7*17.4 in
(64.7*40*44.1cm)

Without handle: 23.6*15.7*17.4 in
(60*40*44.1cm)

Big zone: 12.2*10.6*13.5 in
(30.9*26.9*34.3cm)

Small zone: 12.2*7.9*6.6 in
(30.9*20*16.7cm)

N.W.: 35.6lb(16.14kg)

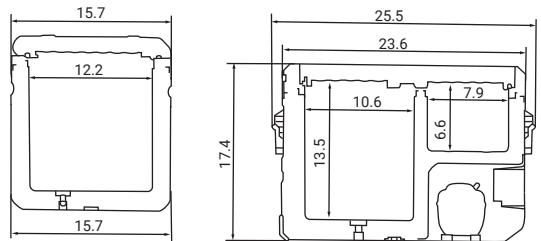

Capacity: 48Quart / 45L

Dimensions:

With handle: 25.5*15.7*19.9 in
(64.7*40*44.1cm)

Without handle: 23.6*15.7*19.9 in
(60*40*50.6cm)

Big zone: 12.2*10.6*16.1 in
(30.9*26.9*40.8cm)

Small zone: 12.2*7.9*9.1 in
(30.9*20*23.2cm)

N.W.: 36.4lb(16.5kg)

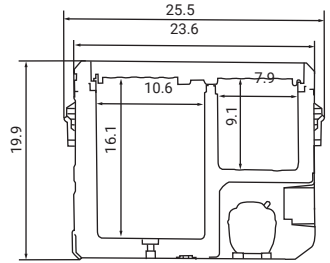
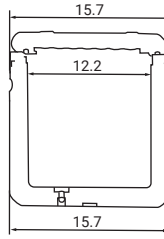

Capacity: 59Quart / 55L

Dimensions:

With handle: 25.5*15.7*22.5 in
(64.7*40*44.1cm)

Without handle: 23.6*22.5*19.9 in
(60*40*57.1cm)

Big zone: 12.2*10.6*18.6 in
(30.9*26.9*47.3cm)

Small zone: 12.2*7.9*11.7 in
(30.9*20*23.2cm)

N.W.: 37.9lb(17.2kg)

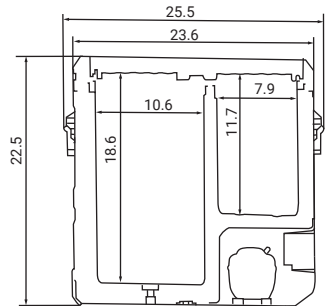
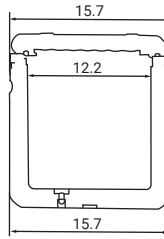

4.3 Procut Structure

*Model:CR03512/ CR04512/ CR05512

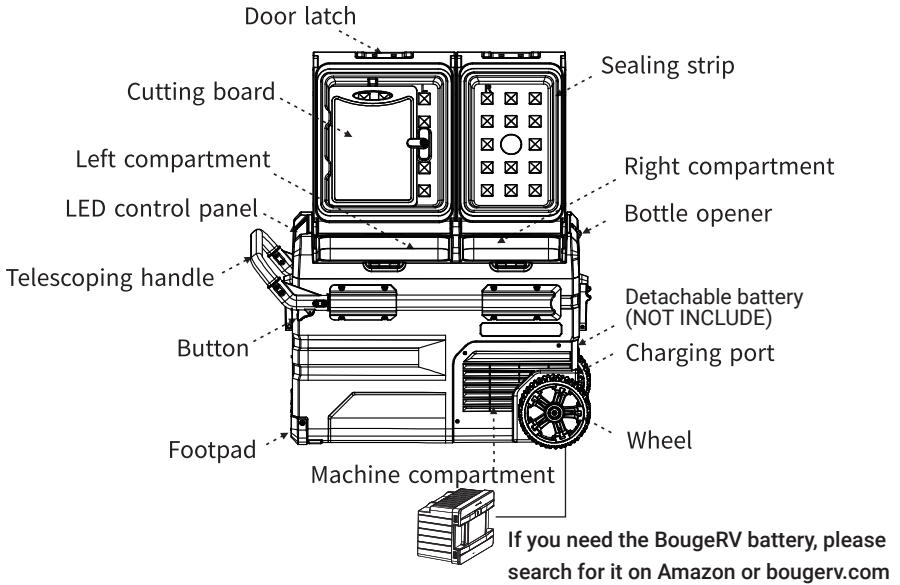

*there are buttons on both sides of the telescoping hand, which can be pressed at the same time to pull the rod.

***Model:CR03512/ CR04512/ CR05512**

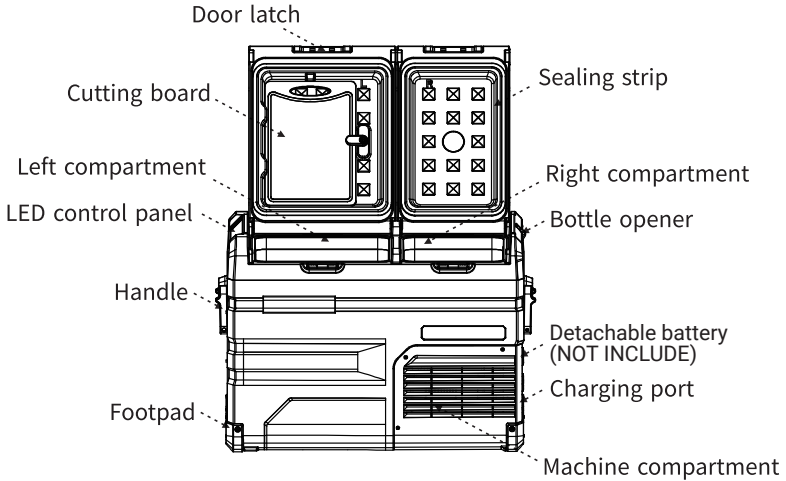

! Note: the package does not include the battery. If you are interested, please search "BougerRV battery" on Amazon or bougerv.com

*Removable battery: press the left and right to remove/insert the battery, it will be heavy in your hand, which is recommended to be hold with carefully and take it out gently.

*The cutting board can be moved by turning the knob on the top cover, it is suggested to clean and dry it after every use.

4.4 Reverse Door Opening Direction

The door opening direction can be changed according to actual needs, please follow the instructions below:

Door Disassembly:

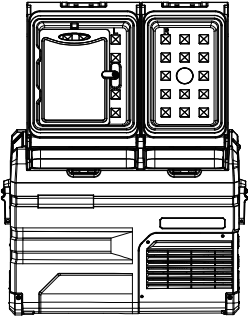

Open the door at a 90° angle

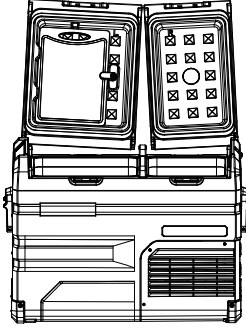

Take off the door from one side

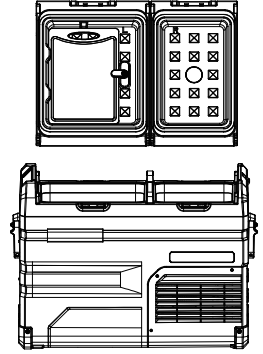

Take off the door from the other side

Door Installation:

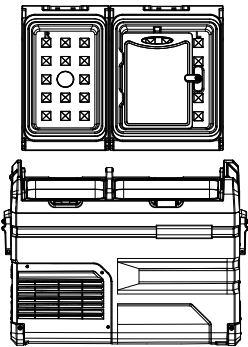

Reverse the door opening direction

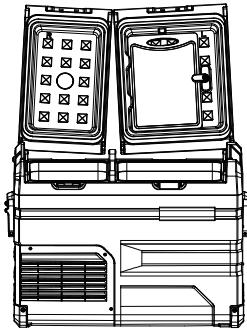

Align the door shaft with the hole on one side and insert it

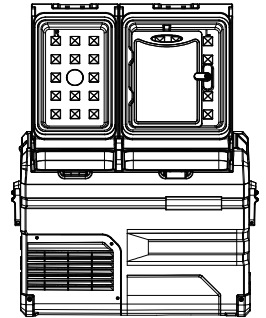

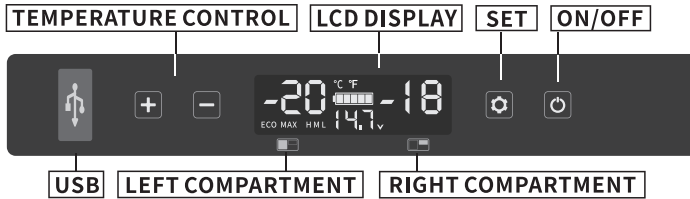

Fix the door on the other side, installation finished

5 Operation Instruction



5.1 Power Supply: Connect to 12V/24V DC power, 100-240V AC power(using the adapter), or use a backup lithium battery which can be recharged by solar(12~50V).

5.2 Display Screen Initialization: Connect to the power supply, the buzzer will make a long beep, and the display will be on for 2 seconds then enter the normal operating mode.



5.3 Turn On/Off: Short press  to turn it on; Press and hold  for 3 seconds to turn it off.

5.4 Temperature Setting

5.4.1 Temp adjustment of the left compartment: When both left and right compartments are set in running state, press **+** or **-** to enter the left compartment temperature setting, press **+** to increase temperature, and press **-** to decrease temperature.

5.4.2 Temp adjustment of the right compartment: Press **+** or **-**, when the temp on the left flash, press  to switch left/right compartment. When the temp on the right is flash, you can press the **+** or **-** adjust the temp. The setting will be saved after stopping operating for four seconds.

(Note: the temperature displayed is the current temperature of the compartments, it'll take a while to reach the set temperature.)

5.4.3 Compartment ON / OFF: Under the running state, long press **+** and  at the same time for three seconds to switch ON/OFF the left compartment, long press **-** and  at the same time for three seconds to switch ON/OFF the right compartment, two compartments cannot be switched off at the same time.

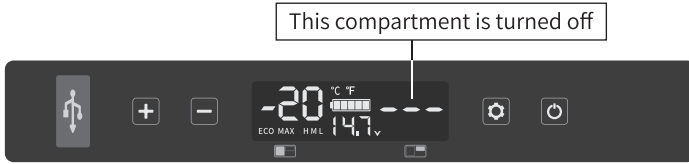





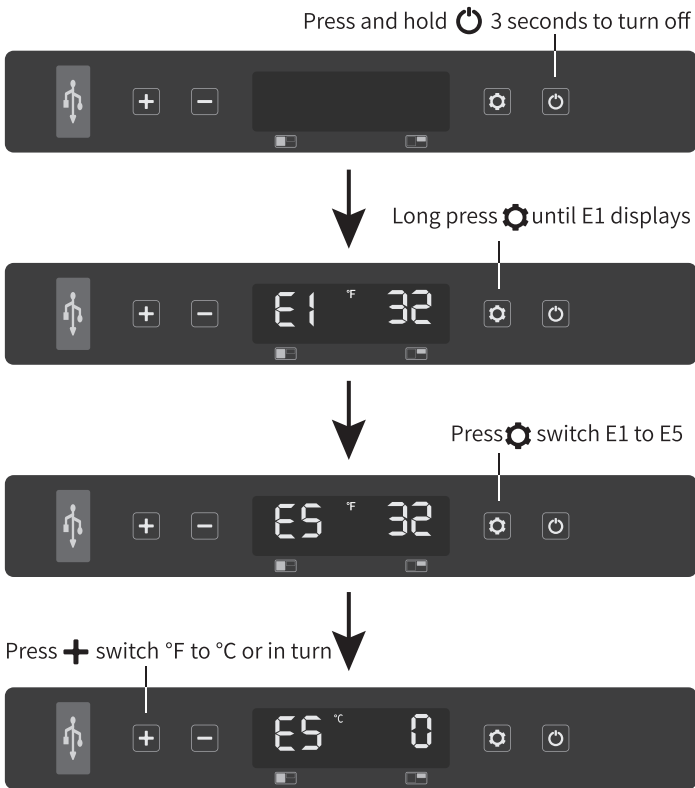

5.5 MAX/ECO Mode Switching: Under the running state, press to switch MAX(fast cooling) and ECO (Energy saving Mode). (*Factory setting is MAX.)



5.6 Temperature Unit Setting: Switch off the fridge, long press for three seconds until E1 displays, then switch to E5 by pressing again. Under E5 mode, press or to select Celsius or Fahrenheit. (*Factory setting is °F.)



Reset: Switch off the fridge, long press for three seconds until E1 displays, under E1 mode, and long press and at the same time for three seconds to reset it.

■ Recommended temperature for common food:

						
Drinks	Fruits	Vegetable	Delicatessen	Wine	Ice cream	Meat
5°C/41°F	5~8°C/41~46°F	3~10°C/37~50°F	4°C/39°F	10°C/50°F	-10°C/14°F	-18°C/0°F

5.7 Car Battery Protection Setting H/M/L: Under the running state, long press  for three seconds until the screen flashes, then press  again to select protection mode H(High), M(Middle), and L(Low).
(*Factory setting is H.)

6 Car Battery Protection(H/M/L) Voltage Reference

Due to the different output voltages between vehicles, H should be set when the product is connected to car power, and M or L should be set when it is connected to a portable power station or other backup battery.

The battery gear should be set from H to M or from M to L if there is a voltage protection code F1 shown on the panel. The battery gear should be set to H if the product keeps working after turning off the car engine, or the product may drain the battery.

Voltage Reference:

INPUT MODE	DC 12V		DC 24V	
	CUT OUT	CUT IN	CUT OUT	CUT IN
L	9.0V	10.9V	21.3V	22.7V
M	10.1V	11.4V	22.3V	23.7V
H	11.1V	12.4V	24.3V	25.7V

*the voltage is theoretical value, there may be a deviation in different sceneries.

*USB output: +5V DC/1A, suitable for small devices like mobile phones, tablets, etc.



Note: the package does not include the battery. If you are interested, please search "BougeRV battery" on Amazon or bougeRV.com.

• **Battery ON/OFF:** Long press the power button of the battery to turn it on/off, and short press to display the current battery.

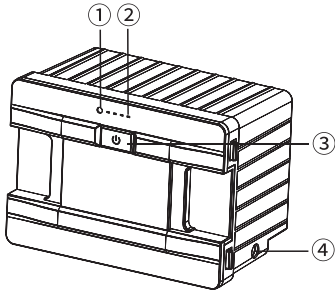

Model: E0404-17301

Capacity: 15600mAh/173Wh

Rated Voltage: 11.1V

Charging Limited Voltage(DC): 12.6V

Charging Limited Current(DC): 3A

① Power Indicator (Green: charging; Blue: discharging)

② Battery Indicator (show current battery)

③ Power Button

④ DC Charging Port

⚠ Warning: do not disassemble the battery!

• **Battery charging (for reference only):**

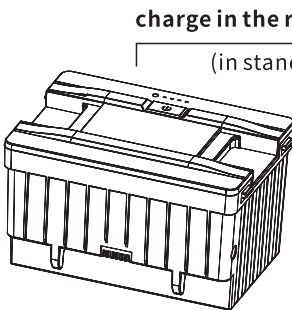

charge in the refrigerator
(in standby mode)

charge separately

Wall outlet AC 100*240V
(using the dedicated adapter)
(Charging time≈8h)

Car cigarette lighter
DC 12/24V
(When the Input voltage>13.5V,
charging time≈8h)

Solar
12~50V
(Connect to the "SOLAR" port of the refrigerator)
(When using 100W solar panel,
charging time≈5h)

Battery charger (optional)
(Connect to the DC charging port of the battery)
(Charging time≈8h)

Charging station (optional)
(Charging time of a single battery≈4h)

· **Battery Saving:** It is recommended to fully charge the refrigerator before your departure, and you can put your food & beverages in the refrigerator in advance so that the battery can last longer. Unplug the battery or turn it off to prevent self-discharge when not in use. *If the refrigerator won't be in use for a long time, fully charge the battery and turn it off.

· **Discharging time (for reference only):** In the low battery protection mode, the battery can last about 4 hours after being fully charged. When the temperature of the refrigerator is set between 2~8°C (ambient temperature 25°C), it can last 10 hours after the internal temperature stabilizes. Remove or switch off the battery to prevent self-discharge when not in use.

Discharge time(ECO and L mode)	
Refrigeration	About 10 hrs
Freezing	About 4 hrs

· **Instruction for solar charging**

Insert the solar charge cable into the refrigerator's "SOLAR" terminal.

MAX Solar Input Voltage: 50V; MAX Solar Input Current: 10A.

When connecting to a solar panel, please place the refrigerator in a cool place to dissipate heat. The battery icon on the refrigerator display will show the charging status when the battery is charging.

The charging input power should be higher than the working power of the refrigerator (about 40-45W), or turn off the refrigerator to enter the standby state, otherwise the battery will not be able to charge. It is recommended to use 100W solar panel.

7 Error Code Problems and Troubleshooting

Issues	Suggestions
Refrigerator does not work	Check if the switch is on.
	Check if the plug and socket are connected well.
	Check if the fuse has been burnt.
	Check if the power supply has malfunctioned.
	Switching on/off the fridge frequently may cause a start delay of the compressor.
Refrigerator compartments are too warm	The door is opened frequently.
	A large amount of warm or hot food was stored recently. Wait for the refrigerator to reach its selected temperature.
	The refrigerator has been disconnected for a while.
Food is frozen	The temperature was set too low, please increase the temperature.
A "water flow" noise from inside the fridge	It's a normal phenomenon, caused by the flow of refrigerant.
There are waterdrops around the refrigerator casing or door gap.	It's a normal phenomenon, the moisture will condense to water when it touches the cold surface of the refrigerator.
The compressor is slightly noisy when starting	It s a normal phenomenon, the noise will be reduced after the compressor works stably.
Code F1 displayed	Possible cause low voltage to the fridge. Adjust the battery protection from H to M or from M to L.
Code F2 displayed	Possible cause: condenser fan is overloaded. Disconnect power to fridge for 30 minutes & re-start.
Code F3 displayed	Possible cause: the compressor starts too frequently. Disconnect power to fridge for 30 minutes & re-start.
Code F4 displayed	Possible cause: compressor not kicking in. Disconnect power to fridge for 30 minutes & re-start.
Code F5 displayed	Possible cause: overheating of the compressor & electronics. Disconnect power to fridge for 30 minutes & re-start.
Code F6 displayed	Possible cause: no parameter can be detected by the controller. Disconnect power to fridge for 30 minutes & re-start.
Code F7 or F8 displayed	Possible cause: temperature sensor is faulty. Contact manufacturer for service.

8 Cleaning and Storage

■ Cleaning

- Unplug the device first to avoid electric shock.
- Use a wet cloth to clean the device and dry it.
- Remove the cover and drain from the hole at the bottom of the device.
- Do not soak the device in water and do not wash it directly.
- Do not use abrasive cleaning agents as these can damage the device.

■ Storage

If the device will not be in use for a long time, please follow the steps:

- Turn off the power and remove the plug.
- Remove all the items stored in the device.
- Remove the cover and drain from the hole, wipe off excess water with a soft rag.
- Leave the lid slightly open to prevent odors from forming.
- Put the device in a cool and dry place.

■ Defrosting

Humidity can form frost in the interior of the cooling device or on the evaporator, which will affect the cooling performance. Defrost the device regularly to avoid this.

- Switch off the device.
- Take out the contents of the device.
- Keep the lid open.
- Remove the cover and drain from the hole.
- Wipe off the defrosted water.



Never use hard or sharp tools to remove ice or to loosen objects which have frozen in place.

9 FAQ

Q1: Is there a cover for this refrigerator?

A1: Yes, there is. You could search for "BougeRV 37/48/59 quart fridge cover" on Amazon.

Q2: Does it come with a battery installed?

A2: No, this refrigerator does not come with a battery. Our batteries are sold separately. You can search "BougeRV battery" on Amazon or bougerv.com

Q3: How to connect the APP?

A3: First Step: Turn on the Bluetooth on your smart device; start the APP and click "Search" to find nearby fridges.

Second Step: Click the fridge icon for Bluetooth pairing (the APP will prompt you to pair the fridge by pressing the set button on the fridge's control panel when connecting the fridge for the first time).

After pairing, the APP will switch to the main interface allowing you to control the fridge.

Q4: How much is the power consumption of the refrigerator?

A4: It is divided into ECO and MAX. The ECO mode is 45W; the MAX mode is 60W.

Q5: What's the Outside temperature range this can be safely used?

A5: Temperature range: 50°F~122°F.

Q6: What is the adjustable temperature range of the refrigerator?

A6: -4 ~68°F.

Q7: How long does it take to cool down to the lowest temperature?

A7: The cooling rate depends on whether the refrigerator is empty or loaded. It usually takes about an hour and a half for the empty box to reach the lowest temperature. The more things in the refrigerator, the slower the cooling speed.

Q8: Does the fridge have to be plugged in for use?

A8: Yes, it must.

Q9: How long can the temperature be maintained after unplugging?

A9: Depends on the ambient temperature around it. If the compartments are filled, it will take longer to warm. If it's empty, it's quick to warm.

Q10: How long can this continuously be run safely?

A10: As long as the power supply is maintained, our portable refrigerators can work 24 hours/ a day, just like home refrigerators.

Q11: Will it keeps ice cream frozen?

A11: Yes. By setting the temperature below 0°F, you can keep the ice cream frozen.

Q12: Can I make ice with ice cube trays?

A12: Yes. The internal temperature of this portable refrigerator is adjustable from -4°F to 68°F. You can get ice cubes by setting the temperature below 32°F.

Q13: Can I get a new replacement if the parts of my refrigerator malfunction?

A13: Sure, we provide a 2-year warranty.

Q14: How can I register for the warranty on my refrigerator?

A14: You can contact our email "service@bougerv.com / bougerv@gmail.com, and we will give you the corresponding solution according to your problem."

10 Warranty and Maintenance

Warranty

BougeRV PORTABLE CAR REFRIGERATOR comes with a 2-year warranty that commences from the date of purchase on BougeRV Amazon Store or BougeRV Official Website, except the following situations:

- Contrived damage.
- Damage caused by force majeure such as earthquake, conflagration, etc.
- Damage from inappropriate use or violating this instruction.
- Damage or malfunction caused by disassembling.

🛡️ 24-month limited warranty

🔧 Lifetime technical support

Customer Service

If there is any problem with the operation or use of the product, please feel free to contact us via:

■ Amazon:

✉ service@bougeRV.com

☎ +1 699 232 7427 (CHN)

9AM-6PM (UTC+8) Monday-Friday

+1 408 656 8402 (US)

9AM-6PM (PT) Monday-Friday

■ BougeRV Website:

✉ support@bougeRV.com

☎ +1 408 429 4149 (CHN)

9AM-6PM (UTC+8) Monday-Friday

+1 408 656 8402 (US)

9AM-6PM (PT) Monday-Friday

VIP Service & Extra 1-year Warranty

1. Search "QR Code" on your FB
2. Scan the QR Code beside
3. Join "BougeRV Car Refrigerator Club"
4. You become a VIP and get a 3-year warranty



11 Specification

Model	CR03512	CR04512	CR05512
Rated Voltage	DC 12V/24V, AC100~240V(using the adapter)		
Rated Power Input	60W		
Capacity	35L/37QT/1.3cu.ft.	45L/48QT/1.6cu.ft.	55L/59QT/2.0cu.ft.
Noise Emission	≤45dB		
Climate Type	T/ST/N/SN		
Temperature Range	-20°C ~ 20°C (-4°F ~ 68°F)		
Dimensions (D*W*H)	711*460*441mm (28.0*18.1*17.4in.)	711*460*506mm (28.0*18.1*19.9in.)	711*460*571mm (28.0*18.1*22.5in.)
Weight	18.4kg/40.7lbs	19.2kg/42.3lbs	19.6kg/43.2lbs

Model	CR03513	CR04513	CR05513
Rated Voltage	DC 12V/24V, AC100~240V(using the adapter)		
Rated Power Input	60W		
Capacity	35L/37QT/1.3cu.ft.	45L/48QT/1.6cu.ft.	55L/59QT/2.0cu.ft.
Noise Emission	≤45dB		
Climate Type	T/ST/N/SN		
Temperature Range	-20°C ~ 20°C (-4°F ~ 68°F)		
Dimensions (D*W*H)	647*400*441mm (25.5*15.7*17.4in.)	647*400*506mm (25.5*15.7*19.9in.)	647*400*571mm (25.5*15.7*22.5in.)
Weight	16.1kg/35.6lbs	16.5kg/36.4lbs	17.2kg/37.9lbs

*Due to product improvement, the technical information might be different from the actual information, please refer to the rating label on the product.

■ Disposal:

Place the packaging material in the appropriate recycling waste bins wherever possible.



If you want to eventually dispose of the product, ask your local recycling center or specialty distributor for details on how to do so in accordance with the applicable disposal regulations.

12 APP Control

First Step: Turn on the Bluetooth on your smart device; start the APP and click "Search" to find nearby fridges.

Second Step: Click fridge icon for Bluetooth pairing (the APP will prompt you to pair the fridge by pressing the set button  on the fridge's control panel when connecting the fridge for the first time). After pairing, the APP will switch to the main interface allowing you to control the fridge.

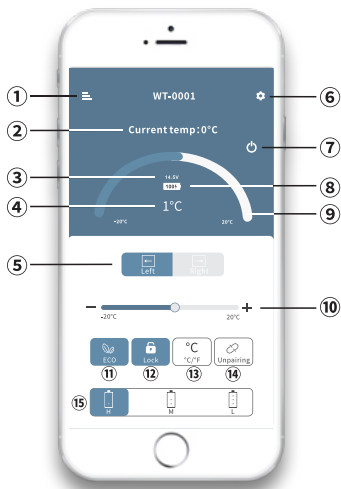

- ① MENU
- ② Current temperature
- ③ Current voltage
- ④ Target temperature
- ⑤ Switch Left/Right compartment
- ⑥ SET
- ⑦ ON/OFF
- ⑧ Current battery
- ⑨⑩ Temperature control
- ⑪ ECO(Energy-saving) / MAX(Fast-cooling)
- ⑫ Lock / Unlock
- ⑬ Celsius / Fahrenheit
- ⑭ Unpairing the device and return to search
- ⑮ Battery protection mode: High/Medium/Low

Note:

*Click the lock icon  on the APP to lock/unlock the control panel on the fridge, if locked, the fridge can only be controlled by the APP.

Downloading the "CAR FRIDGE FREEZER" Application



iOS



Android

Scan the QR code on the left or search for the "CAR FRIDGE FREEZER" APP in the iTunes APP Store (for Apple devices) or Google Store (for Android devices).

Explore more from BougeRV



@bougerv



@Bougervofficial



BougeRV