



OWNER'S MANUAL

VACUUM CLEANER

Read this owner's manual thoroughly before operating the appliance and keep it handy for reference at all times.

ENGLISH

A9*****



MFL69883677
Rev.03_102721

www.lg.com

Copyright © 2021 LG Electronics Inc. All Rights Reserved.

TABLE OF CONTENTS

3 IMPORTANT SAFETY INSTRUCTIONS

- 3 READ ALL INSTRUCTIONS BEFORE USE
- 3 WARNING STATEMENTS
- 8 CAUTION STATEMENTS

9 INSTALLATION

- 9 Product Overview
- 12 Storing the Accessories

14 OPERATION

- 14 Getting Started
- 16 Charging the Battery
- 17 Using the Mop Nozzle
- 20 Using the Nozzles and Tools

23 SMART FUNCTIONS

- 23 Using LG ThinQ Application
- 25 Smart Diagnosis™ Function

26 MAINTENANCE

- 26 Cleaning the Appliance
- 29 Cleaning the Nozzle

32 TROUBLESHOOTING

- 32 Before Calling for Service

35 LIMITED WARRANTY

- 35 USA

IMPORTANT SAFETY INSTRUCTIONS

READ ALL INSTRUCTIONS BEFORE USE

Safety Messages

Your safety and the safety of others are very important.

We have provided many important safety messages in this manual and on your appliance. Always read and follow all safety messages.



This is the safety alert symbol.

This symbol alerts you to potential hazards that can kill or injure you and others. All safety messages will follow the safety alert symbol and either the word WARNING or CAUTION.

These words mean:



WARNING

You may be killed or seriously injured if you do not follow instructions.



CAUTION

You may be injured or cause damage to the product if you do not follow instructions.

All safety messages will tell you what the potential hazard is, tell you how to reduce the chance of injury, and tell you what may happen if the instructions are not followed.

WARNING STATEMENTS

WARNING

- To reduce the risk of explosion, fire, death, electric shock, injury or scalding to persons when using this product, follow basic precautions, including the following:

Technical Safety

- This appliance is not intended for use by persons (including children) with reduced physical, sensory or mental capabilities, or lack of experience and knowledge, unless they have been given supervision or instruction concerning use of the appliance by a person responsible for their safety.
- Do not allow the appliance to be used as a toy. Close attention is necessary when used by or near children.
- Do not allow children to play with or hang on the appliance.
- Do not use the appliance with a damaged power cord or plug. The cord must be replaced. If the appliance is not working as it should, has been dropped, damaged, left outdoors, or dropped into water, return it to an LG Electronics service center.
- Do not pull or carry by the cord, use the cord as a handle, close a door on the cord, or pull the cord around sharp edges or corners. Do not run the appliance over the cord. Keep the cord away from heated surfaces.
- Do not unplug by pulling on the cord. To unplug, grasp the plug, not the cord.
- Place the cords from other appliances out of the area to be cleaned.
- Have servicing performed by a qualified repair person using only identical replacement parts. This will ensure that the safety of the product is maintained.

Battery

- Never use the battery, adapter, and the charging station from other appliances with this appliance. Use only the battery and the charging station provided by LG Electronics.
- Use appliances only with specifically designated battery packs. Use of any other battery packs may create a risk of injury and fire.
- Recharge only with the charger specified by the manufacturer. A charger that is suitable for one type of battery pack may create a risk of fire when used with another battery pack.
- Never use the battery, adapter, and the charging station from this appliance with other appliances.
- Unplug the power cord and remove the battery if the appliance will not be used for an extended period of time.
- Do not use modified or damaged batteries.
- When disposing of the battery or the appliance, remove the battery from the appliance and safely dispose of it.
- Do not use a battery pack or appliance that is damaged or modified. Damaged or modified batteries may exhibit unpredictable behavior resulting in fire, explosion or risk of injury.
- Do not disassemble, remove or short-circuit the battery.
- Have the battery replaced when it is no longer able to hold a charge.
- Refer to the **Charging the Battery** section instructions for the method of replacing the battery.
- When disposing of this appliance, follow regulations for disposal of rechargeable lithium-ion batteries.
- Follow all local ordinances and regulations when handling or disposing of the battery.
- Disconnect the battery pack before cleaning or servicing.
- Prevent unintentional starting. Ensure the switch is in the off position before connecting to the battery pack, picking up or carrying the appliance. Carrying the appliance with your finger on the switch or energizing an appliance that has the switch on invites accidents.
- Disconnect the battery pack from the appliance before making any adjustments, changing accessories, or storing appliance. Such preventive safety measures reduce the risk of starting the appliance accidentally.
- When the battery pack is not in use, keep it away from other metal objects, like paper clips, coins, keys, nails, screws or other small metal objects, that can make a connection from one terminal to another. Shorting the battery terminals together may cause burns or a fire.
- Under abusive conditions, liquid may be ejected from the battery. If this happens, avoid contact. If contact accidentally occurs, flush with water. If liquid contacts eyes, additionally seek medical help. Liquid ejected from the battery may cause irritation or burns.
- Do not modify or attempt to repair the appliance or the battery pack (as applicable) except as indicated in the instructions for use and care.

Battery Specifications

- One or two batteries are provided. The number of batteries varies depending on the model purchased.
 - **Model Name:** EAC63382208
 - **Type:** Rechargeable Lithium-ion Battery
 - **Rated Capacity:** DC 25.9 V, 2.4 Ah/62.16 Wh(Min. 2.3 Ah/59.57 Wh)

Installation

- To avoid an electrical shock or fire, do not install, charge or store the appliance where it may be exposed to water, rainfall or high humidity.
- Install, charge and store the appliance in a well-ventilated place.

- Avoid operating the appliance in areas where there is a risk of leakage of flammable gas, industrial oil or metallic dust.
- Do not store or install the appliance, power cord or plug near heating devices or open flames.
- Install the charging station on a firm, level surface.
- Do not use or store the appliance at temperatures below 41 °F (5°C) or above 100 °F (38°C).
- Do not store or install the appliance where it is exposed to temperatures below freezing or exposed to outdoor weather conditions.
- When installing or moving the appliance, be careful not to pinch, crush, or damage the power cord or plug.

Operation

- Use only as described in this manual. Use only manufacturer's recommended attachment.
- This appliance is designed for normal indoor domestic use only. It is not to be used for any non-residential, commercial, or industrial application.
- Do not use or store the appliance in any outdoor location, garage environment or on wet surfaces.
- This product should only be used with a 120 V~ 60 Hz outlet. Make sure to check the power specifications of the place where you intend to use the appliance.
- Do not handle the power cord, plug, or appliance controls with wet hands.
- Wipe any moisture or dirt off the cord or plug with a dry cloth.
- Unplug the power cord using the plug, not the cord. Pulling on the cord can damage it and result in electric shock or fire.
- Never attempt to operate this appliance if it is damaged, malfunctioning, partially disassembled, or has missing or broken parts, including a damaged cord or plug. Take it to an authorized LG Electronics service center or dealer for assistance.
- Do not apply excessive force to the power cord to bend it, or place it under a heavy object as this will damage it.
- Do not use multiple-outlet adapters with this appliance. Make sure to use a power socket with a capacity of 10 A.
- Do not plug the appliance into a damaged or loose outlet.
- Make sure to unplug the power cord when the appliance is not to be used for an extended period of time.
- Do not damage, alter, excessively bend, twist, pull, pinch or heat the power cord.
- Before using the appliance, remove any wire or string on the floor.
- Avoid touching the prongs of the power plug with your finger(s) when unplugging the power cord.
- Do not cover the power cord with a rug or carpeting.
- Push the power plug firmly into the wall outlet so that it is not loose.
- If the product has been submerged, contact an LG Electronics service center or dealer for instructions before resuming use.
- If the product makes a strange noise or emits an odor or smoke, discontinue use and contact an LG Electronics customer information center.
- Only qualified technicians or service personnel from LG Electronics may disassemble, repair or modify the appliance.
- Never insert a sharp metal object such as a pin, nail or knife in a hole or gap in the appliance or the charging station.
- Do not vacuum liquids with this appliance. Make sure that no water, beverage or detergent gets inside the appliance or the charging station.
- Do not allow the appliance to sweep up blades, thumb tacks, sawdust, sharp objects, or hot or cold ashes.

6 IMPORTANT SAFETY INSTRUCTIONS

- Do not allow children to use the appliance.
- Do not let children or pets get close to the appliance when using, charging or storing.
- Do not insert the nozzle or tools in your mouth.
- Keep clothing and hair, fingers, or other parts of the body away from openings and moving parts.
- Do not operate the appliance with the suction inlet or outlet blocked.
- Do not use in an enclosed space where vapors are present from paint thinner, mothproofing substances, flammable dust or other explosive or toxic materials.
- Make sure that the filter is installed before use.
- Do not use with the dust bin opened.
- Do not touch the charging terminals on the appliance or the charging station, or insert an electrified object inside the appliance or the station.
- Always store the appliance on the charging station when it is not in use.
- Do not lean the appliance on walls, chairs or tables.
- If the earth leakage breaker is tripped when the product is put on the charging station, immediately remove the appliance from the charging station. Contact an LG Electronics customer service center.
- Use extra care when cleaning on stairs.
- Do not use or store a heating device or flammable substance (ether, benzene, alcohol, chemicals, combustible sprays, insecticide, air freshener or cosmetics) in close proximity to the appliance.
- Do not attempt to clean up a liquid substance (water, beverage), odorous substances (candy, chocolate, pet excrement), metal objects (blades, pins), flammable substances, surfactants, or glass shards with this appliance.
- In the event of a gas leak (natural gas, propane gas, etc.) do not operate this or any other appliance. Open a window or door to ventilate the area immediately.
- Do not hold the charging station upside down with the battery in the charging station.
- Do not expose the appliance, and the battery in particular, to heat, a heating device or direct sunlight.
- Do not keep the appliance or its battery inside a vehicle which is exposed to direct sunlight.
- Never allow any water, beverage or detergent to get inside the battery.
- Do not apply physical impacts to the battery.
- Do not put any object into openings. Do not use with any opening blocked; keep free of dust, lint, hair, and anything that may reduce airflow.
- Do not use to pick up flammable or combustible liquids, such as gasoline, or use in areas where they may be present.
- Do not pick up anything that is burning or smoking, such as cigarettes, matches, or hot ashes.
- Do not use the appliance without the dust bin and filters in place.

Maintenance

- Make sure to unplug the power cord when cleaning or maintaining the charging station.
- Do not wash the inlet port or the dust bin with water or detergent.
- Do not use detergents, polishes or air fresheners to clean the dust bin.
- Do not spray or use water, inflammable materials such as gasoline or thinners, or surfactants such as detergent or bath soap near the appliance.
- Wash hands after handling nozzles. The nozzles contain carbon fiber, and contact may cause minor skin irritation.

Disposal

- Keep packing materials out of the reach of children. Packaging materials can pose a suffocation risk for children.
- Destroy the carton, plastic bag, and other packing materials after the appliance is unpacked. Children might use them for play. Cartons covered with rugs, bedspreads, or plastic sheets can become airtight chambers.
- Dispose of this appliance according to local, state, and regional laws and regulations.
- Contact your local city council or the related government authority before disposing of this appliance.
- In case a rechargeable battery is included in this product, the entire device should be recycled in compliance with rechargeable battery recycling standards because of the internal battery. To dispose of properly, call (800) 822-8837 or visit www.call2recycle.org.

Mop Nozzle

- Do not use the mop nozzle to clean up sharp objects such as glass shards, wires, blades, or pins. The sharp objects could become embedded in the mop pads and cause injury when you clean the pads.

CAUTION STATEMENTS

CAUTION

- To reduce the risk of injury to persons, malfunction, or damage to the product or property when using the appliance, follow basic safety precautions, including the following:
-

Operation

- This appliance has a built-in safety device to prevent damage from overheating. If the appliance becomes overheated after extended use, it may automatically turn off. If this occurs, leave the appliance in a cool, well-ventilated area for about an hour before turning on the power again.
- Do not subject the product to shocks or drop it.
- Secure the appliance in the charging station when not in use, to avoid it falling over.
- Do not install wet or damp filters.
- Make sure to wipe up any liquid such as water or oil or pet excrement from the floor before using the appliance.
- Do not clean the product with a volatile or organic solvent (thinner or acetone).
- Always use a soft cloth to clean the appliance.
- Remain aware of your surroundings while using the appliance to avoid colliding with people or animals.
- Do not kick or apply force to the appliance.
- Do not put any object other than the appliance, especially a metallic or magnetic object, on the charging station.
- Do not clean the same spot repeatedly for an extended period of time.
- Vibration from the inlet port or rotating brush may damage the floor or the carpet.
- Keep fingers away from pinch points when assembling the appliance or the charging station.
- Do not let a child or a pet hang onto the charging station.
- Do not apply force or any impact to the cyclonic mesh filter.
- Do not remove the battery during operation.

Mop Nozzle

- Do not use the mop nozzle for purposes other than domestic floor cleaning. The product is not designed for purposes such as polishing a car or cleaning windows.
- When using the mop nozzle, always attach the mop pads.
- Do not clean coated, rough or delicate floating floors or any kind of carpet with the mop nozzle.
- Do not use the mop nozzle to clean the same spot repeatedly for an extended period of time.
- Do not step on the mop nozzle.
- Wet floors can pose a slip hazard. Allow floors to dry completely before allowing anyone to walk on them.
- Do not store the appliance with a full water tank attached to the mop nozzle.

SAVE THESE INSTRUCTIONS

INSTALLATION

Product Overview

The images in this guide may be different from the actual components and accessories, which are subject to change by the manufacturer without prior notice for product improvement purposes.

NOTE

- For your safety and for extended product life, use only authorized components. The manufacturer is not responsible for product malfunction, property damage or bodily injury caused by the use of separately purchased unauthorized components, parts, or non-LG products.

Front View

† This feature is only available on some models.

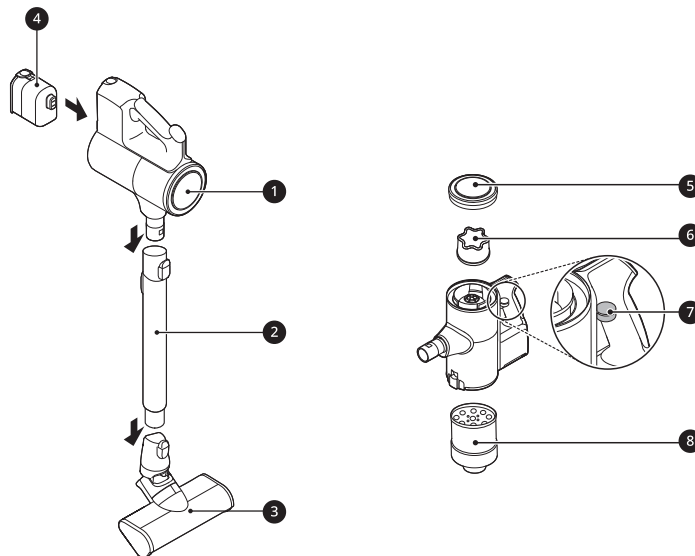

- ❶ Product Body
- ❷ Extension Pipe
- ❸ Nozzle
- ❹ Battery (Dual Battery[†])
- ❺ Exhaust Filter
- ❻ Pre-filter
- ❼ Kompressor Lever
- ❽ Cyclonic Mesh Filter

10 INSTALLATION

NOTE

- Use the vacuum cleaner only with the provided charging station. Using a charging station other than the one designed to be used with the vacuum cleaner may result in improper sealing of the product and failure to empty dust from the vacuum cleaner.
-

Accessories

† This accessory is only available on some models.

Included Accessories

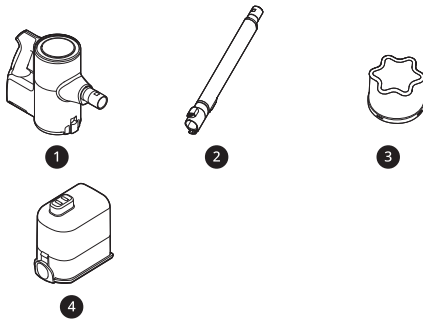

- ❶ Product Body
- ❷ Extension Pipe
- ❸ Pre-filter
- ❹ Battery (Dual Battery[†])

Basic Accessories



- ❶ Combination Tool
- ❷ Crevice Tool
- ❸ Cleaning Brush

Nozzles

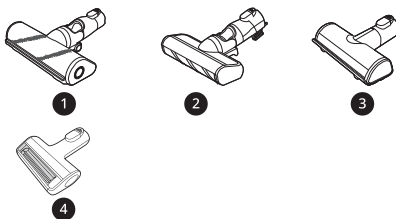

- ❶ Universal Nozzle[†]
- ❷ Slim Hard Floor Nozzle[†]
- ❸ Bedding Nozzle[†]
- ❹ Pet Nozzle[†]

Tools and Accessory Bag

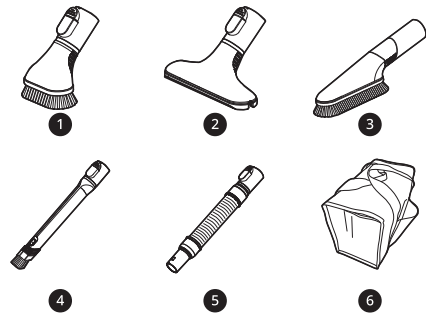

- ❶ Hard Dirt Tool[†]
- ❷ Mattress Tool[†]
- ❸ Multi-angle Tool[†]
- ❹ Flexible Crevice Tool[†]
- ❺ Flexible Hose Extension[†]
- ❻ Accessory Bag[†]

Mop Kit

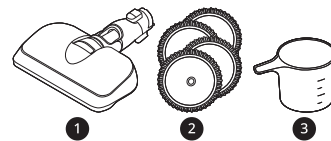

- ❶ Mop Nozzle[†]
- ❷ Mop Pads for General Cleaning[†]
- ❸ Water Tank Filler[†]

NOTE

- The mop pads, batteries, exhaust filter and the pre-filter will eventually need to be replaced. Contact an LG Electronics customer service center.

Specifications

Appliance

Model	A9*****	
Dimensions (Width X Depth X Height)	10.2 in X 10.6 in X 44.1 in 260 mm X 270 mm x 1120 mm	
Weight	Approximately 5.95 lb (2.7 kg)	
Power Consumption	370 W in Turbo Mode (Maximum 590 W) 120 W in Power Mode 68 W in Normal Mode	
Battery Run Time (Using two battery)	Using with the Nozzle[†] Up to 12 minutes in Turbo Mode Up to 40 minutes in Power Mode Up to 80 minutes in Normal Mode	Using with the Tool Up to 14 minutes in Turbo Mode Up to 60 minutes in Power Mode Up to 120 minutes in Normal Mode
Battery Run Time (Using one battery)	Using with the Nozzle[†] Up to 6 minutes in Turbo Mode Up to 20 minutes in Power Mode Up to 40 minutes in Normal Mode	Using with the Tool Up to 7 minutes in Turbo Mode Up to 30 minutes in Power Mode Up to 60 minutes in Normal Mode

- Dimensions are given for the assembled product body, extension pipe and nozzle.
- Battery run time is the result of using a fully charged battery according to the LG Electronics test standard. Results may be different depending on actual use environment and period of use.
- Recommended maximum run time when using the mop nozzle is 80 minutes. Otherwise, the motor may overheat.

[†] The Nozzle contains the direct drive motor that rotates the nozzle cleaning head directly.

Charging Station

Model	VDS-ST1****
Input	120 V~ 60 Hz
Output	DC 28.3 V / 1.15 A
Power Consumption	9 A (Cleaning) 0.6 A (Charging)

Storing the Accessories

Assembling and Storing the Appliance

Follow these steps to safely assemble the appliance.

- 1** Firmly attach the extension pipe **3**, nozzle **4**, or tool onto the product body **1**.
 - To detach the extension pipe, press the extension pipe release button **2**.

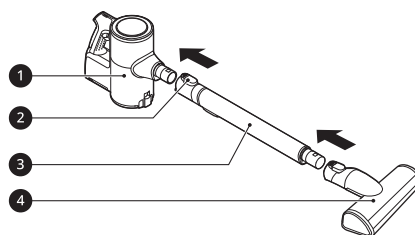

- 2** Put the product body on the charging station.
 - If the vacuum cleaner fits properly inside the charging station, the alarm will sound. Wait several seconds and if the alarm does

not sound, reinsert the vacuum cleaner, making sure that the nozzle is horizontal.

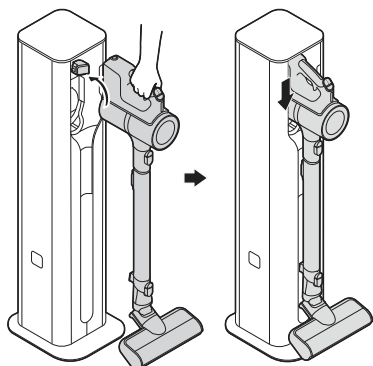

Storing the Tools

Use the product to store the inlet and components provided with the vacuum cleaner.

The components may differ depending on the vacuum cleaner model.

Using the Nozzle Hooks

- 1 Open the nozzle hook ① on both sides of the product.
 - To open the nozzle hooks, press on the right side. Be careful not to pinch fingers when opening.

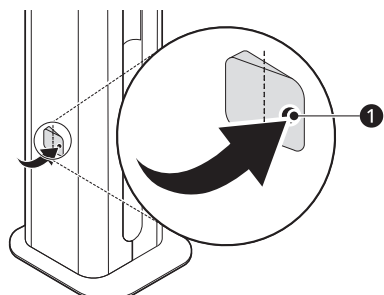

- 2 Hang the nozzle on the nozzle hook.

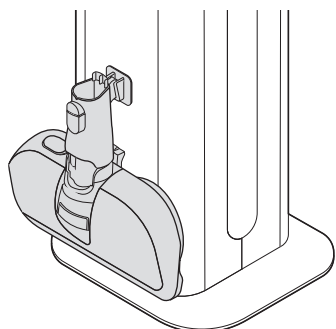

Storage Inside

- 1 Open the left door of the product and insert the bedding nozzle or the pet nozzle ① for storage.

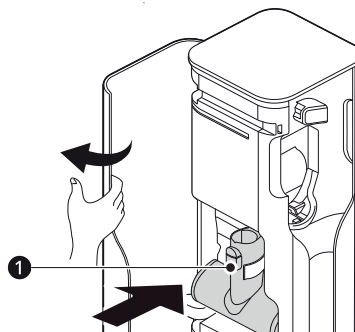

- 2 Open the right door and insert the combination tool ②, the crevice tool ③ and the cleaning brush ④ for storage.

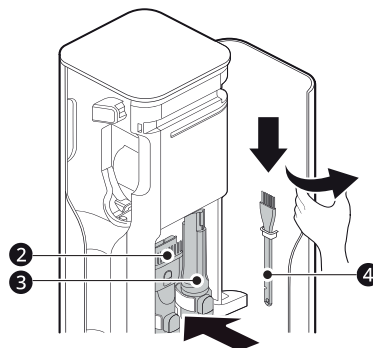

NOTE

- Before moving the product, unplug it and remove the vacuum cleaner, nozzles, and accessories.
- To carry the product, open both doors and hold the areas shown.

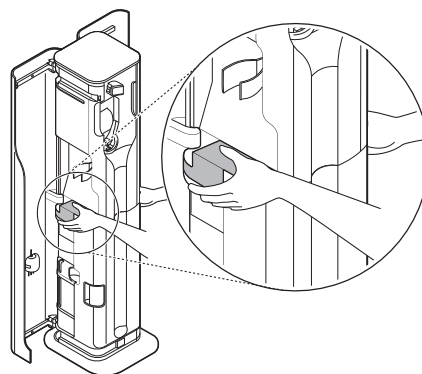

OPERATION

Getting Started

Before Using the Appliance

- Make sure that the exhaust filter and pre-filter are properly assembled before using the appliance.
- Close the dust bin cover properly before using the appliance. If the dust bin cover is left open, the suction strength may deteriorate and affect the cleaning performance.
- This appliance has a built-in safety device to prevent overheating. If the appliance becomes overheated after extended use, it may automatically turn off. If this occurs, leave the appliance in a cool, well-ventilated area for about an hour before turning on the power again.
- Make sure to remove any foreign object such as a sock or stocking before using the appliance. Any foreign object on the inlet port or extension pipe will prevent the appliance from functioning properly.
- Environmental conditions such as temperature and humidity may cause static electricity to accumulate on the appliance. Please contact LG Electronics customer information center if the problem persists.
- Please use the product at normal room temperatures as the battery runtime may deteriorate severely if used at temperatures lower than 41 °F (5°C) or higher than 100 °F (38°C) for an extended period of time.
- Do not use the appliance to suck up oils or any liquids, including water.
- Support the bottom of the appliance when cleaning an elevated surface.
- Store the appliance in the charging station or place it flat on the floor when not in use. Leaning the appliance against a wall or chair can result in product damage or personal injury if the appliance falls.
- To avoid scratches on polished floors, keep the brushes of the nozzles and tools free from grit, sand, or abrasive objects.
- Refer to the **Specifications** section for battery runtime details.
- The battery runtime is dependent on the surface type and the suction power.
- Follow manufacturer's recommendations when cleaning flooring, carpets, and rugs.

- Do not use tools to clean a TV, monitor or LCD display as they may scratch these surfaces.

Assembling Attachments

Nozzles and tools can be attached to either the product body or the end of the extension pipe.

⚠ CAUTION

- Running the appliance for a long period of time with a tool connected may cause the motor to overheat.
- This appliance has a built-in safety device to prevent overheating. If the appliance becomes overheated after extended use, it may automatically turn off. If this occurs, leave the appliance in a cool, well-ventilated area for about an hour before turning on the power again.
- Do not use the Kompressor lever while the appliance is running. Doing so may cause product damage.

- 1 Insert the fully charged battery ① into the cavity at the bottom of the handle on the product body.

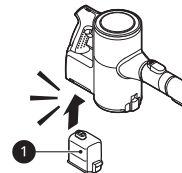

- 2 Attach the nozzles, tools, or extension pipe by sliding them onto the inlet ② on the body until they click into place. The nozzles and tools can also be attached to the end of the extension pipe ②.

- Detach the accessories by pressing the release button ③.

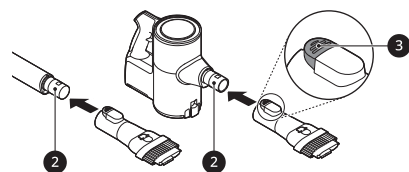

- 3** Adjust the extension pipe by pressing the length adjustment button **4** on the back of the pipe and sliding until it clicks into place at the desired length.

- The extension pipe extends in four steps.

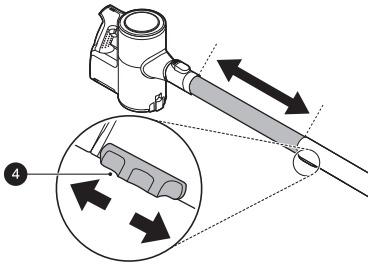

- 4** Press the **Power** button to activate the **Normal** mode.

- To turn off the appliance, press the **Power** button again.

Adjusting the Suction Power

Adjust the suction power using the suction power adjustment button on the handle.

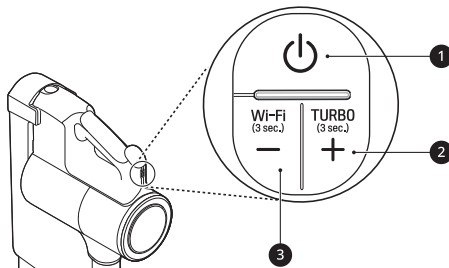

1 Power Button

- Press the **Power** button to turn the appliance on or off.
- Press the **Power** button to activate **Normal** mode.

2 Suction Power Up (+) Button / Turbo Mode

- Press the + button to increase the suction power. (**Normal**→**Power**→**Turbo**)
- Press and hold the + button for more than 3 seconds to activate **Turbo** mode from **Power** mode.

3 Suction Power Down (-) Button / Wi-Fi Mode

- Press the - button to decrease the suction power. (**Turbo**→**Power**→**Normal**)
- Press and hold the - button for 3 seconds to activate Wi-Fi and connect the appliance in the **LG ThinQ** application.

Display

The handle of the appliance displays indicators for clogged objects, filter cleaning alerts, appliance connection status, and the remaining battery charge.

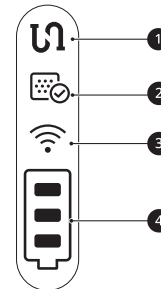

1 Clogged Objects Indicator

- This indicator lights up when the interior of the product body, extension pipe, inlets, nozzle, exhaust filter, pre-filter, or cyclonic mesh filter is clogged with foreign objects.
- If clogging persists, the motor will cycle and the appliance will shut off. Remove the foreign objects and clean the exhaust filter, pre-filter and cyclonic mesh filter following the steps in the **Removing Foreign Objects** section.

2 Filter Cleaning Cycle Alarm Indicator

- This indicator lights up when the appliance is used for a certain period of time. Clean the exhaust filter, pre-filter and cyclonic mesh filter if necessary.

3 Wi-Fi Indicator

- This indicator blinks when the appliance is connecting to the **LG ThinQ** application or home Wi-Fi network, and the indicator lights up when the connection is complete.

4 Battery Level Indicator

- The remaining battery level is displayed in 3 stages according to the remaining battery power.
- The battery level indicator blinks when the battery needs to be charged.
- As the product is charging, bars light up on the battery level indicator to indicate the level of charge.
- When charging is complete, the battery level indicator lights up briefly and then turns off to save energy.

Charging the Battery

Before Charging the Battery

- Make sure that the adapter is connected to both the charging station and the power outlet.
- Fully charging a single battery usually takes about 4 hours. It will take twice as long to charge both the main and auxiliary batteries.
- The battery will not be charged if the indoor temperature is below 41 °F (5°C). Only charge the battery when indoor temperatures are between 41 °F (5°C) and 100 °F (38 °C).
- The battery will eventually need to be replaced. Due to the battery characteristics, runtime is shortened after using the appliance repeatedly for an extended period.
- The last bar on the battery indicator begins to blink when the battery needs to be recharged. Use the appliance with a fully charged battery.
- If the main battery is charging on the charging station, the auxiliary battery will only start charging once the main battery is fully charged.
- To maintain battery life on dual-battery models, swap the positions of the two batteries periodically, between the main body and the auxiliary charging station.

Charging the Product Body

Storing the appliance on the charging station automatically recharges the battery.

- 1 Press the **Power** button to turn the appliance off.
- 2 Put the product body onto the charging station by aligning it to the hook ❶ of the charging station.
 - Make the extension pipe its shortest length and insert it into the appliance.
 - The appliance cannot be loaded onto the charging station if either the combination tool or the crevice tool is inserted. Use the charging station only after removing the combination tool or the crevice tool, if either happens to be fitted.
 - If you don't hear a beep, reload the appliance on the charging station, making sure the nozzle is horizontal.
 - When charging is complete, the battery level indicator (■ ■ ■) lights up briefly and then turns off to save energy.

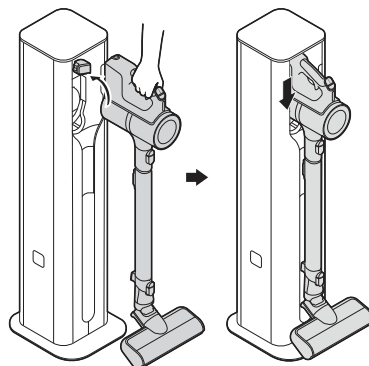

⚠ WARNING

- Make sure to securely fit the product body onto the charging station. If the appliance falls off the charging station, it could cause injuries, property damage or product damage.

Charging the Auxiliary Battery

After the vacuum cleaner has finished charging, the auxiliary battery will start charging.

One or two batteries are provided. The number of batteries varies depending on the model purchased.

- 1 Lift the front of the control panel located at the top of the charging station.

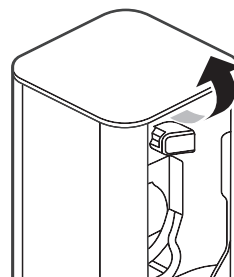

- 2 To insert, align the battery with the outline of the battery charger.

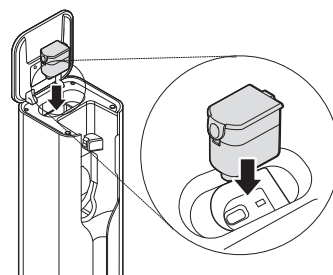

- 3 Press the battery down into the compartment.

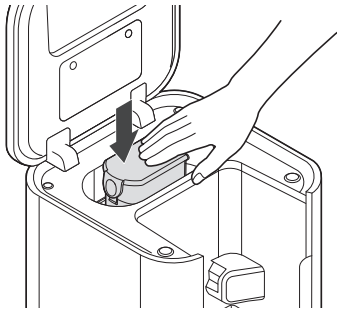
**NOTE**

- Insert the auxiliary battery completely. If the auxiliary battery is inserted correctly, the auxiliary battery icon (🔋) flashes.
- The auxiliary battery icon (🔋) in the status display flashes during charging and then lights up briefly and turns off to save energy when charging is complete.

Using the Mop Nozzle

Before Use

- You cannot adjust the rotation speed of the mop plates on the mop nozzle.
- To prevent product damage, the mop plate will automatically stop if there are foreign objects stuck in the plate or if it is subjected to a strong impact. Turn the appliance off immediately and remove the foreign objects or obstructions before resuming use.
- If you hear a noise while mopping, the mop pad may have dropped off the mop plate. Turn off the product immediately and reattach the pad to the mop plate before resuming use.
- Do not use a soiled mop pad to clean floors.
- Set the water adjustment button to the **STOP** position before carrying the appliance around with the mop nozzle attached.
- Use only authorized LG Electronics mop pads.
- Take care not to accidentally hit the **Water Adjustment** button at the rear of the mop nozzle while cleaning around chairs or table legs. The water supply level could change or be turned to off.

Using the Mop Nozzle

This accessory is only available on some models.

When the mop nozzle is attached, the suction is turned off and only the mop function operates. Press the **Power** (🔌) button to turn the mop on/off.

- The rotation speed of the mop plates is constant and cannot be adjusted.

CAUTION

- Do not assemble or disassemble the nozzle while the appliance is turned on. Doing so may result in injury.
- Set the water adjustment button to the **STOP** position when not using the appliance for an extended period of time. Failure to do so may result in product failure.
- Do not let the appliance stand on the floor while the wet mop pads are attached. Doing so may result in damage or swelling to wood flooring.
- Do not use on PVC or polyurethane mats for infants or children. Friction can cause the motor to overheat.

NOTE

- If you use the mop nozzle for a long time, the motor may overheat. (Recommended maximum run time is 80 minutes.) If the motor overheats, a safety function is activated and the appliance automatically turns off. Set the appliance in a cool, well-ventilated place and allow it to cool down for about an hour before resuming use.

Filling the Water Tank

Before mopping, you must fill the water tank and attach it to the mop nozzle.

- 1 Press the **PUSH** button (1) to remove the water tank from the mop nozzle.

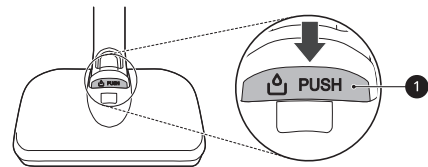

- 2 Open the water inlet cap (2) on the side of the water tank and fill the tank with water using the water tank filler (3).

- Open only one water inlet cap to fill the water. Opening both caps may cause the water to flush.
- Do not fill the tank over the **MAX** line (4).
- Do not use detergent or any liquid other than water in the water tank.

18 OPERATION

- The tank can be filled from either end.

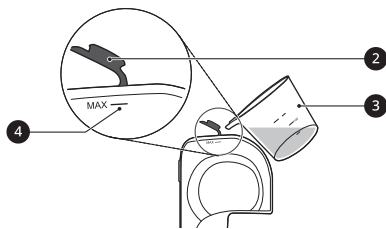

- 3** Close the water inlet cap tightly.
- If the water inlet cap is not closed properly, water may leak.

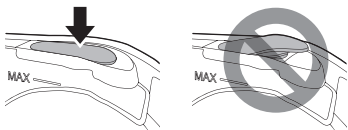

- 4** Attach the water tank to the mop nozzle again.
- Insert the 2 tabs **5** at the front of the water tank into the slots **6** on the top of the mop nozzle. Lower the back of the water tank into place.
 - Press down at the center **7** to lock the tank in place.

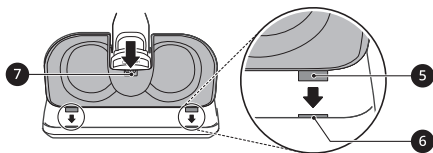

Attaching the Mop Pads

Use the standard mop pads for general cleaning. For stubborn stains, use the heavy duty mop pads.

⚠ WARNING

- To avoid injury, do not attach the mop pads while the mop plates are moving.
- Do not insert your hand between the rotating mop plates. Doing so may result in injury.

- 1** Wet both sides of the mop pads with water and squeeze out any excess water before attaching the pads.
- Do not attach pads while they are dripping wet.

- Attaching and using mop pads while they are dry may affect the cleaning performance.

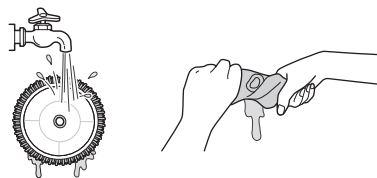

- 2** Place the mop nozzle upside down on the floor.
- 3** Align and attach the center of the mop pad with the center of the mop plates.
- Press firmly to attach the Velcro on the mop pad to the mop plate. Attaching the mop pad upside down or improperly may affect the cleaning performance.

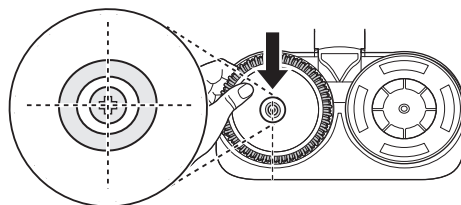

- 4** Attach the mop nozzle to the appliance.

Adjusting the Amount of Water

Press the **Water Adjustment** button at the rear of the mop nozzle to adjust the amount of water released onto the mop pad.

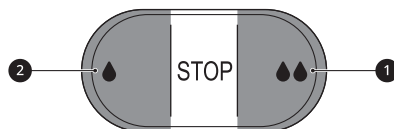

- **High Mode:** Press the **High Mode** button **1** all the way down to clean ingrained dirt or supply a large amount of water.
- **Low Mode:** Press the **Low Mode** button **2** all the way down to supply a small amount of water for cleaning wood or other flooring that can be damaged by too much water.
- **STOP:** Press the **Low Mode** or **High Mode** button halfway to toggle back to the **STOP** position. This stops the supply of water so you can go over areas that are already wet.
- By default, the water adjustment button is set to **STOP**.

Using the Mop Nozzle

- 1 Attach the water tank and mop pads to the mop nozzle.
- 2 Press the **Water Adjustment** button to adjust the amount of water.
- 3 Press the **Power**  button to start cleaning.

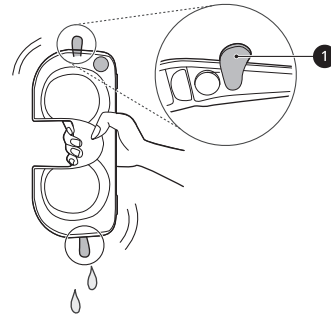

Drying the Water Tank and Mop Pads

Drying the Water Tank

When cleaning is completed, make sure to empty the water tank and dry it before storing the mop nozzle.

CAUTION

- Turn the water inlet caps to make sure they remain open when storing the water tank. If the caps are closed and the tank is not completely dry, the trapped moisture can cause odors.
- Do not remove the water inlet caps from the water tank. Caps may tear.
- Do not add detergent, vinegar or baking soda to the water tank when washing. It is not easily removed from the water tank, and may soil floors.
- After cleaning, wipe off any remaining water from the water supply inlet  on the mop nozzle with a soft cloth. The water could drip onto the floor and damage it.

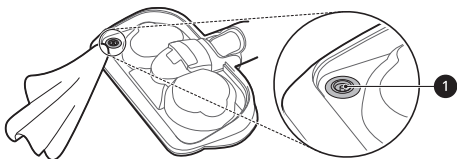

- Do not pull or stretch the rubber gasket on the water supply inlet. Doing so may tear or damage it.

- 1 Open the 2 water inlet caps  on the sides of the water tank and empty the water tank. Shake the water tank to remove any remaining water.

- 2 Leave the 2 water inlet caps open and allow the water tank to dry in a well-ventilated area out of direct sunlight for at least 24 hours.
 - Only store the water tank once it is completely empty and dry. Moisture or residual water in the tank may cause odor.

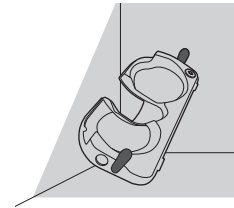

Drying the Mop Pads

After using the mop pads, hand wash them and allow them to dry before storing them.

CAUTION

- Follow these precautions to prevent mop pads from becoming deformed.
 - Do not use bleach or fabric softener when washing the mop pads.
 - Do not dry the pads in a clothes dryer.
 - Do not boil the mop pads.

- 1 Separate the mop pads from the mop plates.
- 2 Hand wash the pads with a neutral detergent.
- 3 Set the pads in a well-ventilated area out of direct sunlight for at least 24 hours or until completely dry.
 - Storing the mop pads before they are completely dry may cause odors.

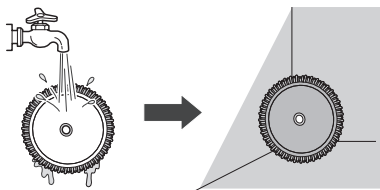

Using the Nozzles and Tools

Before Using the Nozzles and Tools

Some accessories are only available on some models.

Specialized attachments can help you clean more effectively. Tools and nozzles can be attached to the product body or the extension pipe.

- Adjust the suction power if the inlet gets stuck on the floor, carpet, or bedding.
- Each nozzle is equipped with a motor and may make a sound when operating.

⚠ CAUTION

- Do not use the Hard Floor Nozzle or Universal Nozzle on PVC or polyurethane mats for infants and children. The mat may stick to the nozzle, making it difficult to operate, causing damage to the mat or static electricity on the appliance. Clean mats using the crevice tool.

Universal Nozzle

Use this nozzle to clean carpets or rugs.

- If used on hard flooring, this nozzle will be noisy.

Slim Hard Floor Nozzle

Use this nozzle to clean hard floor surfaces.

Pet Nozzle

Use this nozzle for soft surfaces and pet hair removal.

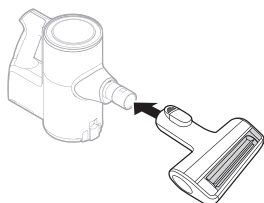

⚠ CAUTION

- Do not use the nozzle on the surfaces listed below. Do not use it to clean coated or lacquered floors especially, as repeated use can wear down the coating.
 - Clothing, bedding
 - Leather sofas, cushions
 - Carpet
 - Vinyl flooring, tiles, marble

Bedding Nozzle

This nozzle lets you clean sheets and bedding more effectively. It removes dust in bedding using strong suction and a punching motion.

- Lower the suction level when vacuuming bedding such as duvet covers to avoid the thin fabric getting sucked into the nozzle.

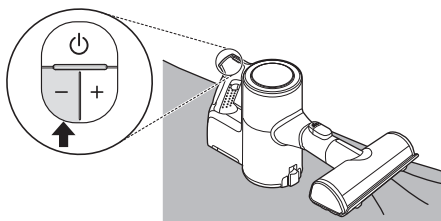

Crevice Tool

Use this tool to remove dust from corners or narrow spaces.

- Use it for areas with static electricity such as mats.
- Use it with the **Turbo** mode to clean pet hair out of furniture, mats, or tight areas like corners.

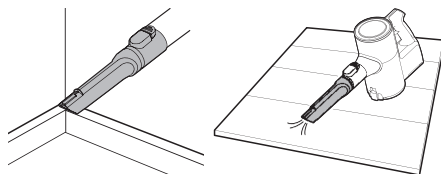

Combination Tool

Can be used in either crevice mode or brush mode for cleaning corners or small gaps where dust and dirt gather.

- **Crevice Mode**

Use the tool in the crevice mode to clean flat surfaces such as sofas or mattresses.

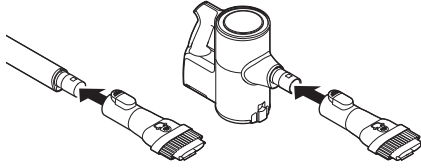

• Brush Mode

Use the tool in the brush mode to clean delicate surfaces such as frames or furniture.

- To convert modes, press the adjustment button ① and push forward.

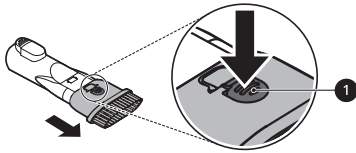

Hard Dirt Tool

Firm bristles remove solidified dirt from hard surfaces. Clean up hair or foreign objects that are entangled in carpets or rugs.

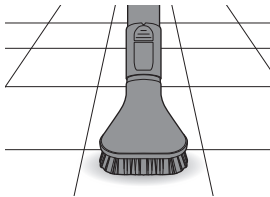

Mattress Tool

Use this tool to clean up dust and foreign objects from mattresses, delicate fabrics, and upholstery.

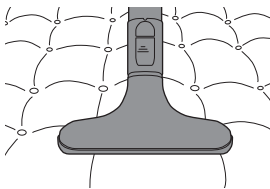

Flexible Crevice Tool

This tool is flexible and its length can be adjusted, making it especially useful for cleaning inside

vehicles or in narrow spaces under and behind furniture where an angled tool is needed.

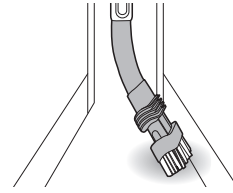

Using the Brush

To convert the tool from crevice to brush mode, press in on the sides of the brush head ① and pull the brush down.

- To convert back to the crevice mode, press in on the brush release button ② and slide the brush up.

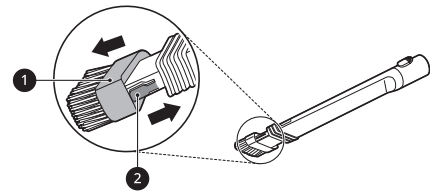

Adjusting the Length

To adjust the length of the tool, press and hold the release button ③ on the side of the tool. Pull or push on the brush head ④ to extend or retract the extension tube.

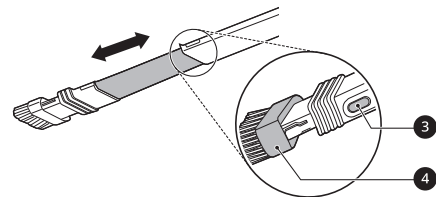

Multi-angle Tool

This tool has a soft brush that can be adjusted to a variety of angles, making it especially useful for cleaning vehicle consoles or the tops of furniture.

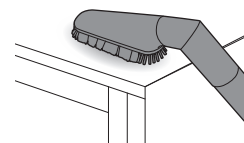

Flexible Hose Extension

Connect this flexible, extendable hose between the product body and the tools to clean hard to reach areas.

22 OPERATION

- The flexible hose extension cannot be used with the Nozzle.

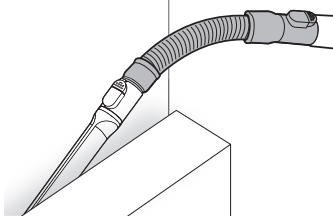

Using the Kompressor Lever

Use the Kompressor lever to compress hair and fibers inside the dust bin after vacuuming and before emptying the dust bin.

- The vacuum must be turned off before using the Kompressor lever.
- Compressing the dust clears it off the interior walls of the dust bin and allows you to vacuum for longer periods before emptying the dust bin. It also makes cleaning the dust bin easier and less messy.
- The dust bin must be at least half full for the compression plate to be effective.
- Press the Kompressor lever down several times to compress the dust and clean off the interior walls of the dust bin.

SMART FUNCTIONS

Using LG ThinQ Application

The **LG ThinQ** application allows you to communicate with the appliance using a smartphone.

LG ThinQ Application Features

• Cleaning History

- Shows the cleaning history, such as monthly cleaning time, cleaning frequency, and cleaning mode, etc.

NOTE

- Assembled suction tool is displayed on the screen during cleaning.
- A notification is displayed on the screen if the pre-filter and the exhaust filter need cleaning.

• Filter Cleaning Cycle Alarm

- After using the appliance for a certain period of time, a notification is displayed on the screen of your smartphone. Clean the exhaust filter or pre-filter, if necessary.

• Cleaning Mode

- The cleaning mode you are using is displayed on the screen of your smartphone.

• Filter Cleaning Guide

- Guide to cleaning the filters.

• Smart Diagnosis™

- This function provides useful information for diagnosing and solving issues with the appliance based on the pattern of use.

NOTE

- If you change your wireless router, Internet service provider, or password, delete the connected appliance from the **LG ThinQ** application and connect it again.
- This information is current at the time of publication. The application is subject to change for product improvement purposes without notice to users.

Before Using LG ThinQ Application

- 1 Use a smartphone to check the strength of the wireless router (Wi-Fi network) near the appliance.
 - If the appliance is too far from the router, the signal becomes weak. It may take a long time to register or fail to install the application.
- 2 Turn off the **Mobile data** or **Cellular Data** on your smartphone.

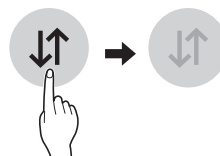

- 3 Connect your smartphone to the wireless router.

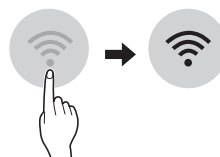

NOTE

- To verify the Wi-Fi connection, check that the Wi-Fi icon on the control panel is lit.
- The appliance supports 2.4 GHz Wi-Fi networks only. To check your network frequency, contact your Internet service provider or refer to your wireless router manual.
- **LG ThinQ** is not responsible for any network connection problems or any faults, malfunctions, or errors caused by network connection.
- The surrounding wireless environment can make the wireless network service run slowly.
- If the appliance is having trouble connecting to the Wi-Fi network, it may be too far from the router. Purchase a Wi-Fi repeater (range extender) to improve the Wi-Fi signal strength.
- The network connection may not work properly depending on the Internet service provider.
- The Wi-Fi may not connect or the connection may be interrupted because of the home network environment.

NOTE

- If the appliance cannot be connected due to problems with the wireless signal transmission, unplug the appliance and wait about a minute before trying again.
- If the firewall on your wireless router is enabled, disable the firewall or add an exception to it.
- The wireless network name (SSID) should be a combination of English letters and numbers. (Do not use special characters.)
- Smartphone user interface (UI) may vary depending on the mobile operating system (OS) and the manufacturer.
- If the security protocol of the router is set to **WEP**, network setup may fail. Change the security protocol (**WPA2** is recommended), and connect the product again.

Installing the LG ThinQ Application

Search for the **LG ThinQ** application from the Google Play Store or Apple App Store on a smartphone. Follow instructions to download and install the application.

Connecting the Appliance to LG ThinQ**Wi-Fi Indicator  Status**

Indicator Status	Description
Blinking	The appliance is connecting.
ON	The appliance has finished connecting. The appliance is connected to Wi-Fi.
OFF	The appliance has been disconnected.

Connecting the Appliance Initially

Select your appliance on menu by pressing the **Add a Product (+)** button. Follow instructions in the **LG ThinQ** to connect your appliance.

Connecting Additional Users

Remove the appliance from the charging station. Follow the instructions under **Connecting the Appliance Initially**.

NOTE

- The usage history will be reset if you delete a connected appliance in **LG ThinQ**.
- If the Wi-Fi signal is weak, the appliance may be temporarily disconnected to the application. When the Wi-Fi signal moves to the normal position, the appliance is connected to the application again.

Turning Wi-Fi On/Off on the Appliance**Disconnecting from Wi-Fi**

To save energy, turn off the Wi-Fi function by pressing the **Wi-Fi** button for 3 seconds while the appliance is charging on the charging station.

Reconnecting to Wi-Fi

Follow the steps below on the appliance.

- 1 Press and hold the **Wi-Fi** button for 3 seconds until the  icon blinks in the display.
- 2 Press the **Wi-Fi** button for 3 seconds again.
 - After the icon turns off, wait for a while and turn it on again.
 - The time before the icon turns on may vary depending on the network environment.

Wireless LAN Module Specifications

Frequency Range	2412 - 2462 MHz
Output Power (Max)	< 30 dBm

FCC Notice

This equipment has been tested and found to comply with the limits for a Class B digital device, pursuant to Part 15 of the FCC Rules. These limits are designed to provide reasonable protection against harmful interference in a residential installation. This equipment generates, uses, and can radiate radio frequency energy and, if not installed and used in accordance with the instructions, may cause harmful interference to radio communications. However, there is no guarantee that interference will not occur in a particular installation. If this equipment does

cause harmful interference to radio or television reception, which can be determined by turning the equipment off and on, the user is encouraged to try to correct the interference by one or more of the following measures:

- Reorient or relocate the receiving antenna.
- Increase the separation between the equipment and the receiver.
- Connect the equipment into an outlet on a circuit different from that to which the receiver is connected.
- Consult the dealer or an experienced radio/TV technician for help.

Any changes or modifications in construction of this device which are not expressly approved by the party responsible for compliance could void the user's authority to operate the equipment.

FCC RF Radiation Exposure Statement

This equipment complies with FCC radiation exposure limit (<4.0 W/kg for extremity (hand) exposure condition) set forth for an uncontrolled environment.

This transmitter must not be co-located or operating in conjunction with any other antenna or transmitter.

Supplier's Declaration of Conformity

Trade Name	LG
Responsible Party	LG Electronics USA, Inc.
Address	111 Sylvan Avenue North Building Englewood Cliffs, NJ 07632
Email	lg.environmental@lge.com

This device complies with part 15 of the FCC Rules. Operation is subject to the following two conditions:

- (1) This device may not cause harmful interference and
- (2) This device must accept any interference received, including interference that may cause undesired operation.

Open Source Software Notice Information

To obtain the source code under GPL, LGPL, MPL, and other open source licenses, that is contained in this product, please visit <http://opensource.lge.com>. In addition to the source code, all referred license terms, warranty disclaimers and copyright notices are available for download.

LG Electronics will also provide open source code to you on CD-ROM for a charge covering the cost of performing such distribution (such as the cost of media, shipping, and handling) upon email request to opensource@lge.com. This offer is valid for a period of three years after our last shipment of this product. This offer is valid to anyone in receipt of this information.

Smart Diagnosis™ Function

Use this feature to help you diagnose and solve problems with your appliance.

NOTE

- For reasons not attributable to LGE's negligence, the service may not operate due to external factors such as, but not limited to, Wi-Fi unavailability, Wi-Fi disconnection, local app store policy, or app unavailability.
- The feature may be subject to change without prior notice and may have a different form depending on where you are located.

Using LG ThinQ to Diagnose Issues

If you experience a problem with your Wi-Fi equipped appliance, it can transmit troubleshooting data to a smartphone using the **LG ThinQ** application.

- Launch the **LG ThinQ** application and select the **Smart Diagnosis™** feature in the menu. Follow the instructions provided in the **LG ThinQ** application.

MAINTENANCE

Cleaning the Appliance

Before Cleaning the Appliance

To maintain the optimum suction power, the cyclonic mesh filter, the exhaust filter and the pre-filter should be cleaned regularly and washed under running water at least once a month.

- Turn off the power before cleaning the appliance.
- The frequency of cleaning varies depending on the usage environment and usage time. In a dusty environment, clean frequently.

⚠ WARNING

- Never wash the Nozzle, rotating brush or product body with water. Water could reach the motor and cause electric shock or fire.
- Do not allow foreign objects to enter the motor. Doing so may cause electric shock, fire or product damage.
- Do not insert fingers or sharp objects into the motor. Doing so could cause product damage, personal injury or electric shock.

⚠ CAUTION

- Do not apply force or allow impacts to the cyclonic mesh filter. Doing so could deform the filter, compromise product performance, or cause the product to malfunction.
- If the Kompressor lever does not return to the top, remove the cyclonic mesh filter from the dust bin and clean it. A clogged or dirty filter may cause poor product performance.

Removing Foreign Objects

If the appliance is clogged with foreign objects, the suction power changes, the motor cycles repeatedly, and the foreign objects clogging alarm icon blinks.

If clogging persists, the appliance will turn off automatically to prevent damage. Separate the battery from the product body and remove the foreign objects before resuming use of the appliance.

- Check the inside of the product body, above the Kompressor working plate, the extension pipe, inlets, exhaust filter, pre-filter and cyclonic mesh filter for foreign objects.

- If the inlets are not completely blocked, the foreign objects clogging alarm indicator may not light up.
- If the sound of the appliance becomes loud or the cleaning performance is poor, check for foreign objects.

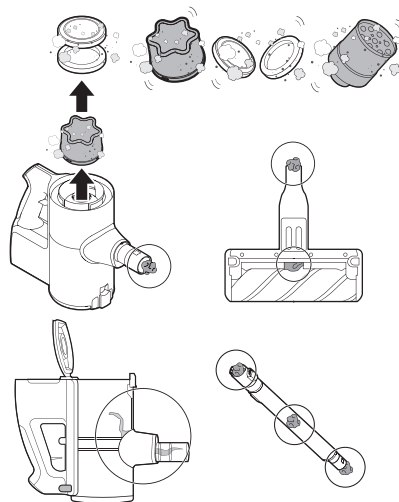

Cleaning the Dust Bin

Empty and clean the dust bin after every use.

- If the dust bin is completely full of dust or the filter is clogged, the suction power may be reduced.

⚠ CAUTION

- Do not use the appliance without the cyclonic mesh filter installed. Doing so could damage the appliance.

- 1 Remove the battery from the product body before cleaning the dust bin.
- 2 Push down the Kompressor lever ① several times to collect and compact the dust from the outside of the cyclonic mesh filter and the interior walls of the dust bin.
 - Foreign objects which become lodged in the cyclonic mesh filter may be difficult to dislodge with the Kompressor lever. Remove the cyclonic mesh filter and use the provided cleaning brush to clean it.

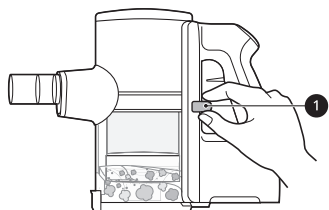

3 Press the dust bin cover release button **2** to open the dust bin cover. Shake the dust bin to empty it.

- Be careful as dust or foreign objects may spill out when opening the dust bin. Empty the dust bin into a wastebasket or where dust and foreign objects can be easily removed.
- The dust bin can be wrapped in a plastic bag to contain the dust when emptying the dust bin.

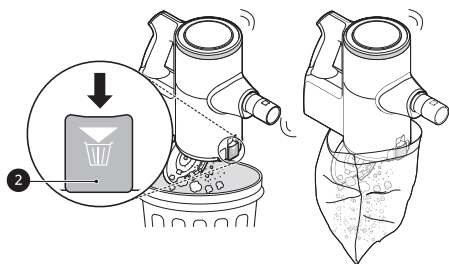

⚠ WARNING

- If the Kompressor lever does not slide down smoothly, foreign objects may be trapped between the dust bin and the cyclonic mesh filter. Clean the dust bin and cyclonic mesh filter to avoid product damage.
- Do not force the Kompressor lever down if foreign objects are caught around the working plate of the Kompressor system. Doing so may cause product damage.

4 Insert the crevice tool **4** into the cyclonic mesh filter **3** and turn it counterclockwise to remove the filter.

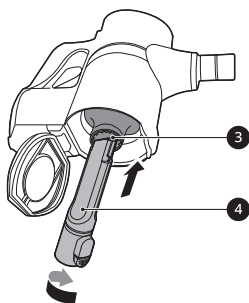

5 Wash the cyclonic mesh filter under running water.

- To avoid odor and the malfunction of the motor, allow the cyclonic mesh filter to dry completely in a well-ventilated area out of direct sunlight for at least 24 hours before reassembling.

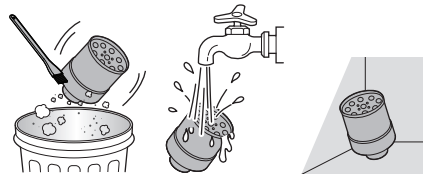

6 Use the combination tool **5** to clean out dust or foreign objects inside the dust bin.

- Do not wash the product body or motor with water.

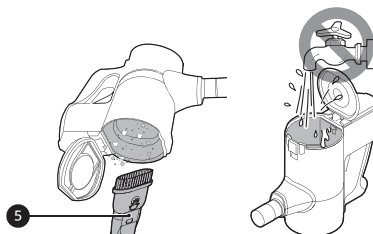

7 Turn the product body over and lift the Kompressor lever **6** up to clean the inside of the working plate with the provided cleaning brush.

- Do not push the Kompressor lever down hard. The working plate may be damaged.

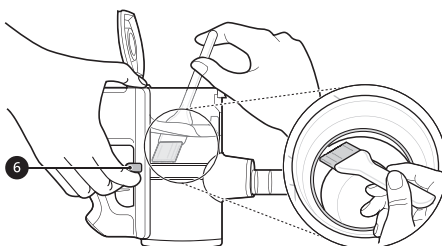

8 Turn the product body over again and shake it while pressing down the lever to remove the dust.

9 Wrap the provided cleaning brush with a wet paper towel, tucked into the slots **7** on the handle.

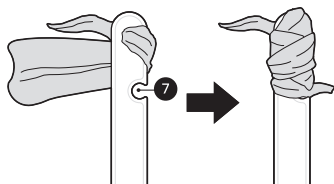

- 10** Turn the product body over, lift the Kompressor lever **8** up, and clean the inside of the working plate with the towel-wrapped brush handle.

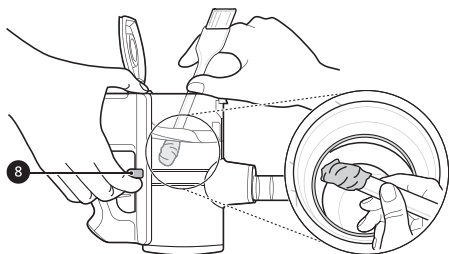

Cleaning the Filters

Clean the pre-filter and exhaust filter regularly and wash them in running water at least once a month to maintain the optimum suction power of the appliance.

- The frequency of cleaning depends on where and how often you use the product. Clean the filters more frequently if the appliance is used regularly or in areas with a lot of dust.
- Filters are consumables. Please purchase more filters from an authorized service center.

- 1** Remove the battery from the product body.

- 2** Rotate the exhaust filter **1** to the unlocked position **2** to separate it from the product body.

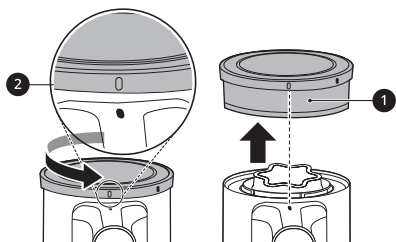

- 3** Grip the exhaust filter cover **3** and the exhaust filter **1** using both hands and rotate the exhaust filter cover while pressing the **PUSH** button in order to separate it from the exhaust filter.

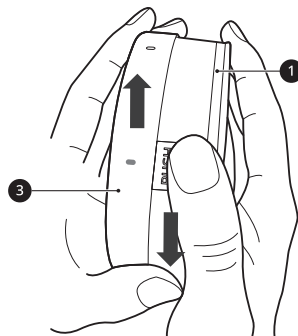

- 4** Lift out the pre-filter **4** from the product body.

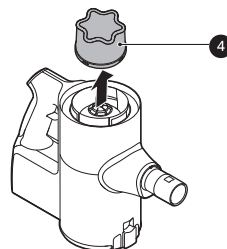

- 5** Use the combination tool **5** to clean any dust off the motor.

- Do not wash the motor with water.

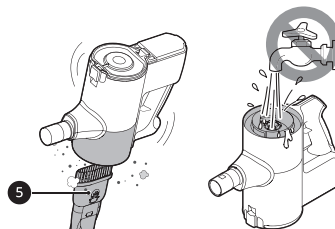

- 6** Clean the exhaust filter by brushing the dust off it regularly and wash it in running water at least once a month.

- To avoid odor and the malfunction of the motor, allow the exhaust filter to dry completely in a well-ventilated area out of direct sunlight for at least 24 hours before reassembling.



7 Clean the pre-filter by brushing the dust off it regularly and wash it in running water at least once a month.

- To avoid odor and the malfunction of the motor, allow the pre-filter to dry completely in a well-ventilated area out of direct sunlight for at least 24 hours before reassembling.

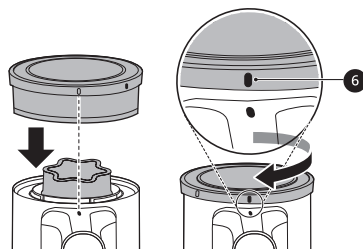
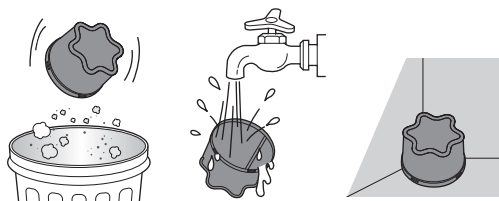

CAUTION

- Do not use the appliance without the exhaust filter and pre-filter installed. Doing so could result in product damage.

8 Align the lock position fo **6** the exhaust filter cover with the letter "H" **7** of the **PUSH** button on the exhaust filter.

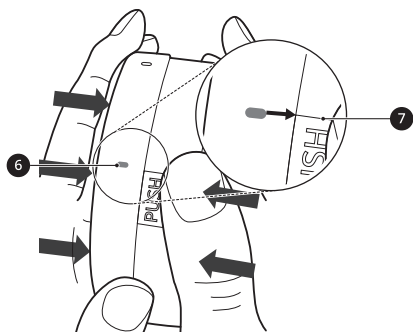

9 Push and insert the exhaust filter cover **3** into the exhaust filter **1** and rotate it to reassemble it and prevent it from falling out.

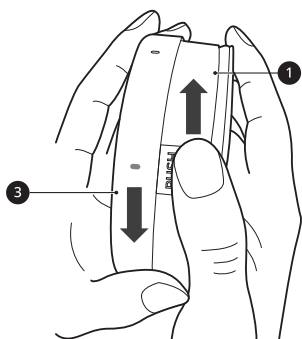

10 Insert the clean, dry pre-filter and rotate the exhaust filter to the locked position **6** to reassemble it on the product body.

Cleaning the Nozzle

Clean the nozzle and rotating brush regularly.

CAUTION

- Always separate the nozzle from the product body or remove the battery before cleaning. If the nozzle starts to operate during cleaning, it could cause an injury.
- Keep fingers away from pinch points when assembling the nozzle on the appliance or the rotating brush on the nozzle.
- Do not use the rotating brush as a wet mop. Doing so may cause product damage.

Cleaning the Universal Nozzle

Clean the brush and roller heads before each use.

- If the brush contains foreign objects, the brush may not spin or a noise may occur during operation.

1 Press the nozzle release button **1** to remove the nozzle from the extension pipe or product body.

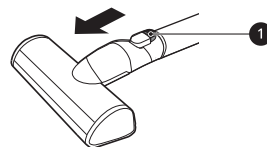

2 Turn the nozzle upside down and rotate the cover lock slot **2** counterclockwise.

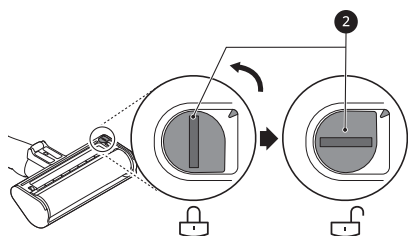

- 3** Pull the brush cover forward and pull the brush out.

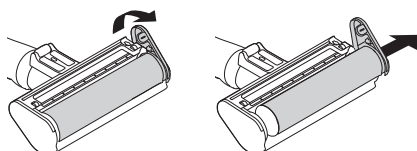

- 4** Attach the crevice tool to the product body and use the vacuum to remove foreign objects and dust from the brush and the bottom of the nozzle.

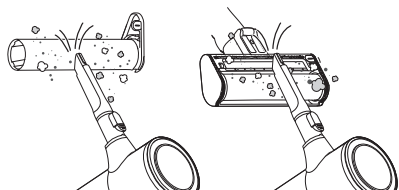

- 5** Use a damp towel or cloth to remove any remaining foreign objects and dust from the brush and the bottom of the nozzle.

- Carefully use a tweezers to remove foreign objects from the nozzle rollers.
- Do not rinse or submerge the rotating brush or nozzle in water.
- Wrap the handle of the cleaning brush with a wet towel or cloth and use it to clean the rotating brush and nozzle.

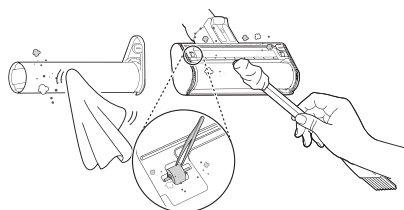

- 6** Slide the brush back into the nozzle and rotate the cover back into place. Turn the cover lock clockwise to lock the cover.

Cleaning the Slim Hard Floor Nozzle

- 1** Press the nozzle release button **1** to remove the nozzle from the extension pipe or product body.

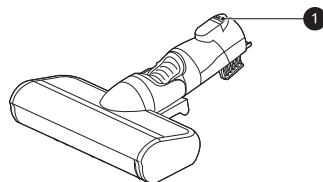

- 2** Turn the nozzle upside down and remove the rotating brush while holding down the **PUSH** button on the nozzle.

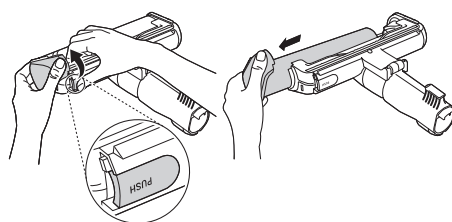

- 3** Attach the crevice tool to the product body and use the vacuum to remove foreign objects and dust from the brush and the bottom of the nozzle.

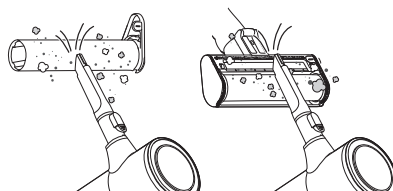

- 4** Use a damp towel or cloth to remove any remaining foreign objects and dust from the brush and the bottom of the nozzle.

- Remove foreign objects from the rollers of the nozzle using tweezers.
- Do not rinse or submerge the rotating brush or nozzle in water.
- Wrap the handle of the cleaning brush with a wet towel or cloth and use it to clean the rotating brush and nozzle.

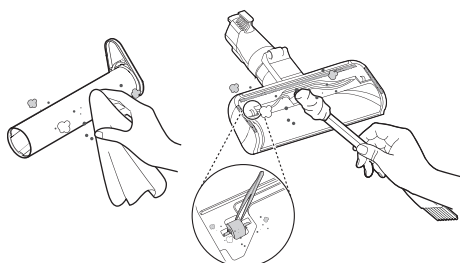

- 5 Slide the brush back into the nozzle until it clicks into place.

Cleaning the Pet Nozzle

- 1 Press the nozzle release button ❶ to remove the nozzle from the extension pipe or product body.

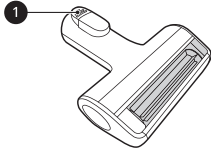

- 2 Hold down the **PUSH** button on the nozzle while removing the rotating brush.

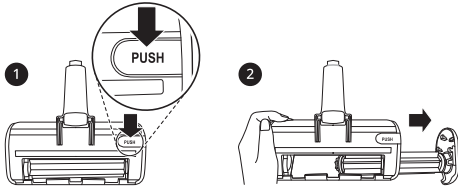

- 3 Attach the crevice tool to the product body and use the vacuum to remove foreign objects and dust from the brush and the bottom of the nozzle.

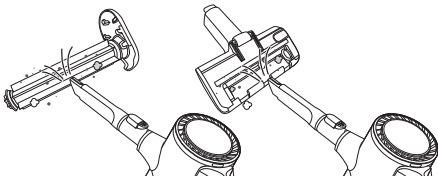

- 4 Use a damp towel or cloth to remove any remaining foreign objects and dust from the brush and the bottom of the nozzle. Remove foreign objects, debris and hair from all nozzle rollers using tweezers.

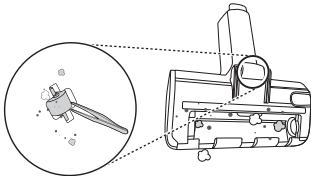

- 5 Insert the left side of the brush ❷ into the groove ❸ inside the nozzle.

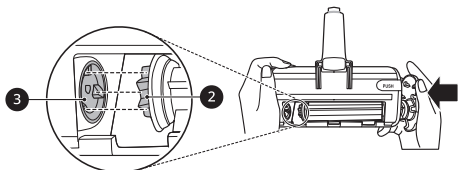

- 6 Press the brush cover until it clicks to lock the brush in place.

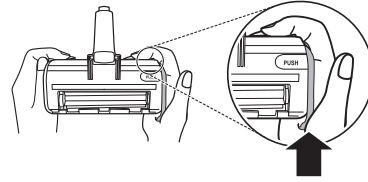

Cleaning the Bedding Nozzle

- 1 Press the nozzle release button to remove the nozzle from the extension pipe or product body and turn the nozzle upside down.

- 2 Attach the crevice tool to the product body and use the vacuum to remove foreign objects and dust from the bottom of the nozzle.

- Use a damp towel or cloth to remove any remaining foreign objects and dust from the bottom of the nozzle. After cleaning, wipe the nozzle dry.
- Do not rinse or submerge the nozzle in water.

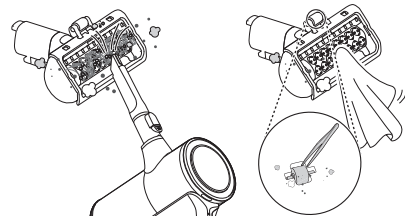

Cleaning the Mop Nozzle

- 1 Press the nozzle release button to remove the mop nozzle from the extension pipe, and turn the nozzle upside down.

- 2 Use a damp towel or cloth to remove any remaining foreign objects and dust from the bottom of the mop nozzle. Remove foreign objects, debris and hair from all nozzle rollers using tweezers.

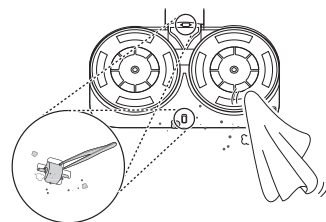

TROUBLESHOOTING

Before Calling for Service

Operation

Problem	Possible Cause & Solution
The appliance does not operate.	Battery is fully discharged. <ul style="list-style-type: none"> Charge the battery.
	Appliance is turned off. <ul style="list-style-type: none"> Press the Power button to turn on the appliance.
Suction power is too weak.	Dust bin is full of dust. <ul style="list-style-type: none"> Empty the dust bin.
	Filters are clogged. <ul style="list-style-type: none"> Clean the pre-filter and the exhaust filter.
	Inlet is clogged. <ul style="list-style-type: none"> Remove any foreign objects from inside the product body or the extension pipe.
	Foreign object is on rotating brush, or in inlet port. <ul style="list-style-type: none"> Remove any foreign objects (thread, hair) from the rotating brush or the inlet port.
The product body does not appear to be charging.	Power cord is unplugged. <ul style="list-style-type: none"> Plug the power cord securely into the outlet.
	Foreign object is on the charging terminals. <ul style="list-style-type: none"> Remove dirt or foreign objects from the charging terminals with a dry cloth.
Hot air is coming from the product body.	Motor is cooling. <ul style="list-style-type: none"> If the appliance is running normally, the hot air is a result of the motor cooling and is not a sign of malfunction.
A strange odor is coming from the appliance.	Appliance was purchased within the last 3 months. <ul style="list-style-type: none"> The cleaner may emit a smell of rubber for about 3 months after purchase.
	Dust bin is full of dust. <ul style="list-style-type: none"> The dust in the bin may cause some odor. Empty the bin and clean it.
	Foreign object is on the filter. <ul style="list-style-type: none"> The filter may emit an odor if it has not been cleaned for some time. Clean the pre-filter and exhaust filter regularly.
	Pre-filter was installed while damp or wet. <ul style="list-style-type: none"> Wash the pre-filter with running water. To avoid odor, allow the pre-filter to dry completely in a well-ventilated area out of direct sunlight for at least 24 hours before reassembling.
	Exhaust filter was installed while damp or wet. <ul style="list-style-type: none"> Wash the exhaust filter with running water. To avoid odor, allow the exhaust filter to dry completely in a well-ventilated area out of direct sunlight for at least 24 hours before reassembling.
The appliance makes too much noise.	Vacuum cleaner is running in Turbo mode. <ul style="list-style-type: none"> The motor may be louder at the higher suction power settings. This is normal.

Problem	Possible Cause & Solution
The appliance turns off unexpectedly or by itself after the motor speed fluctuates repeatedly.	Battery is not fully charged. <ul style="list-style-type: none"> The battery must be fully charged before cleaning. If the problem persists when the battery is fully charged and the pipes and attachments are clear from obstructions, contact an LG customer information center for service.
	Foreign object is in the product body, extension pipe, inlet port or nozzle. <ul style="list-style-type: none"> Remove any foreign objects from the product body, extension pipe, inlet port or nozzle.
	Filters are clogged. <ul style="list-style-type: none"> Clean the pre-filter and the exhaust filter.
The rotating brush does not rotate.	Brush is improperly installed. <ul style="list-style-type: none"> Remove the brush, clean it if necessary and attach it again.
	Foreign object is on rotating brush. <ul style="list-style-type: none"> Remove any foreign objects from the rotating brush.

Mop Nozzle

Problem	Possible Cause & Solution
The mop plates do not rotate.	Mop pads are improperly installed. <ul style="list-style-type: none"> Remove the mop pads, clean them if necessary and attach them again.
	Mop nozzle is pressed too hard against the floor. <ul style="list-style-type: none"> The mop plates stop automatically to protect the product. This is not a failure. Attach the mop pads securely to the mop plates and press the Power button to resume use.
	Foreign object is between mop plates and mop pads. <ul style="list-style-type: none"> Remove foreign objects from the mop plates and press the Power button to resume use.
There is no water coming out of the mop nozzle.	Water tank is empty. <ul style="list-style-type: none"> Fill the water tank. Remove the battery or detach the nozzle before filling the water tank.
	Water tank is improperly attached to mop nozzle. <ul style="list-style-type: none"> Properly attach the water tank to the mop nozzle. Remove the battery or detach the nozzle before properly securing the water tank to the nozzle.
	Water Adjustment button is set to STOP. <ul style="list-style-type: none"> Press the High or Low Water Adjustment button all the way down. The water will not come out if the button is set to STOP.
	The water outlet was clogged by hard water scale or other foreign substances. <ul style="list-style-type: none"> Use a sharp pin to remove the blockage.
There is moisture in the water tank.	Water tank was not allowed to dry completely after use. <ul style="list-style-type: none"> Empty the water tank, set it out of direct sunlight, and allow it to dry completely after use.
The mop makes the floor dirty or smells strange.	Mop pads were not cleaned properly after use. <ul style="list-style-type: none"> Clean the mop pads thoroughly after each use. Using soiled mop pads may make the floor dirtier.

Wi-Fi

Problem	Possible Cause & Solution
Your home appliance and smartphone are not connected to the Wi-Fi network.	Battery is fully discharged. <ul style="list-style-type: none"> • Charge the battery, then register your appliance on LG ThinQ.
	The password for the Wi-Fi that you are trying to connect to is incorrect. <ul style="list-style-type: none"> • Find the Wi-Fi network connected to your smartphone and remove it, then connect your appliance on LG ThinQ.
	Mobile data for your smartphone is turned on. <ul style="list-style-type: none"> • Turn off the Mobile data of your smartphone and connect the appliance using the Wi-Fi network.
	The wireless network name (SSID) is set incorrectly. <ul style="list-style-type: none"> • The wireless network name (SSID) should be a combination of English letters and numbers. (Do not use special characters.)
	The router frequency is not 2.4 GHz. <ul style="list-style-type: none"> • Only a 2.4 GHz router frequency is supported. Set the wireless router to 2.4 GHz and connect the appliance to the wireless router. To check the router frequency, check with your Internet service provider or the router manufacturer.
	The appliance is too far from the router. <ul style="list-style-type: none"> • If the appliance is too far from the router, the signal may be weak and the connection may not be configured correctly. Move the location of the router so that it is closer to the appliance.

LIMITED WARRANTY

USA

TERMS AND CONDITIONS

ARBITRATION NOTICE: THIS LIMITED WARRANTY CONTAINS AN ARBITRATION PROVISION THAT REQUIRES YOU AND LG ELECTRONICS (“LG”) TO RESOLVE DISPUTES BY BINDING ARBITRATION INSTEAD OF IN COURT, UNLESS YOU CHOOSE TO OPT OUT. IN ARBITRATION, CLASS ACTIONS AND JURY TRIALS ARE NOT PERMITTED. PLEASE SEE THE SECTION TITLED “PROCEDURE FOR RESOLVING DISPUTES” BELOW.

Should your LG Vacuum Cleaner (“Product”) fail due to a defect in materials or workmanship under normal and proper use, during the warranty period set forth below, LG will, at its option, repair or replace the Product. This limited warranty is valid only to the original retail purchaser of the Product (“You”) and applies only when purchased lawfully and used within the United States including U.S. Territories.

WARRANTY PERIOD	
Vacuum Cleaner	Smart Inverter Motor (Suction Motor)
One (1) year from the date of original retail purchase	Ten (10) years from the date of original retail purchase
Parts and Labor (internal/functional parts only)	Parts only (You will be charged for labor)

- Replacement Products and parts are warranted for the remaining portion of the original warranty period or ninety (90) days, whichever is greater.
- Replacement Products and parts may be new, reconditioned, refurbished, or otherwise factory remanufactured.
- Replaced Product or part(s) will be the property of LG.
- Proof of original retail purchase specifying the Product model and date of purchase is required to obtain warranty service under this limited warranty.
- Warranty start date will be ninety (90) days from manufacture date absent valid proof of purchase.

EXCEPT TO THE EXTENT PROHIBITED BY APPLICABLE LAW, ANY IMPLIED WARRANTY OF MERCHANTABILITY OR FITNESS FOR A PARTICULAR PURPOSE ON THE PRODUCT IS LIMITED IN DURATION TO THE DURATION OF THE ABOVE LIMITED WARRANTY. UNDER NO CIRCUMSTANCES SHALL LG OR ITS U.S. DISTRIBUTORS/DEALERS BE LIABLE FOR ANY INDIRECT, INCIDENTAL, CONSEQUENTIAL, SPECIAL, OR PUNITIVE DAMAGES, INCLUDING, WITHOUT LIMITATION, LOST GOODWILL, LOST REVENUES OR PROFITS, WORK STOPPAGE, IMPAIRMENT OF OTHER GOODS, COST OF REMOVAL AND REINSTALLATION OF THE PRODUCT, LOSS OF USE, OR ANY OTHER DAMAGES WHETHER BASED IN CONTRACT, TORT, OR OTHERWISE. LG’S TOTAL LIABILITY, IF ANY, SHALL NOT EXCEED THE PURCHASE PRICE PAID BY YOU FOR THE PRODUCT.

SOME STATES DO NOT ALLOW THE EXCLUSION OR LIMITATION OF INCIDENTAL OR CONSEQUENTIAL DAMAGES OR LIMITATIONS ON HOW LONG AN IMPLIED WARRANTY LASTS, SO THE ABOVE EXCLUSIONS OR LIMITATIONS MAY NOT APPLY TO YOU. THIS LIMITED WARRANTY GIVES YOU SPECIFIC LEGAL RIGHTS AND YOU MAY ALSO HAVE OTHER RIGHTS THAT VARY FROM STATE TO STATE.

THIS LIMITED WARRANTY DOES NOT COVER:

- Service trips to deliver, pick up, install, or clean, or to correct wiring or unauthorized repairs.
- Service trips to educate how to assemble, operate, or maintain the Product.
- Damage or failure of the Product to perform during power failures and interrupted or inadequate electrical service.
- Damage or failure of the Product resulting from operating the Product in a corrosive atmosphere or contrary to the Product owner’s manual.

36 LIMITED WARRANTY

- Damage or failure of the Product caused by accidents, pests and vermin, lightning, wind, fire, floods, acts of nature, or any other causes beyond the control of LG.
- Damage or failure of the Product caused by unauthorized modification or alteration, or if the Product is used for other than the intended purpose.
- Damage or failure of the Product caused by incorrect electrical current or voltage.
- Damage or failure of the Product caused by transportation, storage, and/or handling, including scratches, dents, chips, and/or other damage to the finish of the Product, unless such damage is reported within one (1) week of delivery.
- Damage or missing items to any display, open box, or discounted Product.
- Refurbished Product or any Product sold "As Is", "Where Is", "With all Faults", or similar disclaimer.
- Products with original serial numbers that have been removed, altered, or cannot be readily determined.
- Increases in utility costs and additional utility expenses.
- Any noises associated with normal operation.
- Products used for other than normal and proper household use (e.g., commercial or industrial use, offices, and recreational facilities or vehicles) or contrary to the Product owner's manual.
- Costs associated with removal and reinstallation of the Product for repairs.
- Replacement of batteries, filters, or any consumable parts.
- The removal and reinstallation of the Product if it is installed in an inaccessible location or is not installed in accordance with the Product owner's manual.
- Damage or failure of the Product resulting from misuse, abuse, improper installation, repair, or maintenance. Improper repair includes the use of parts not authorized by LG. Improper installation or maintenance includes installation or maintenance contrary to the Product owner's manual.
- Damage or failure of the Product caused by the use of parts, components, accessories, consumable cleaning products, detergents, chemicals, or any other products or services that are not authorized by LG.

The cost of repair or replacement under these excluded circumstances shall be borne by You.

TO OBTAIN WARRANTY SERVICE AND ADDITIONAL INFORMATION

Call 1-800-243-0000 and select the appropriate option from the menu.

Or visit our website at <http://www.lg.com>

Or by mail: LG Electronics Customer Service P.O. Box 240007 Huntsville, AL 35813 ATTN: CIC

PROCEDURE FOR RESOLVING DISPUTES:

ALL DISPUTES BETWEEN YOU AND LG ARISING OUT OF OR RELATING IN ANY WAY TO THIS LIMITED WARRANTY OR THE PRODUCT SHALL BE RESOLVED EXCLUSIVELY THROUGH BINDING ARBITRATION, AND NOT IN A COURT OF GENERAL JURISDICTION. BINDING ARBITRATION MEANS THAT YOU AND LG ARE EACH WAIVING THE RIGHT TO A JURY TRIAL AND TO BRING OR PARTICIPATE IN A CLASS ACTION.

Definitions. For the purposes of this section, references to "LG" mean LG Electronics U.S.A., Inc., its parents, subsidiaries and affiliates, and each of their officers, directors, employees, agents, beneficiaries, predecessors in interest, successors, assigns and suppliers; references to "dispute" or "claim" shall include any dispute, claim or controversy of any kind whatsoever (whether based in contract, tort, statute, regulation, ordinance, fraud, misrepresentation or any other legal or equitable theory) arising out of or relating in any way to the sale, condition or performance of the product or this Limited Warranty.

Notice of Dispute. In the event you intend to commence an arbitration proceeding, you must first notify LG in writing at least 30 days in advance of initiating the arbitration by sending a letter to LG at LG Electronics, USA, Inc. Attn: Legal Department- Arbitration 111 Sylvan Avenue, Englewood Cliffs, NJ 07632. You and LG agree to engage in good faith discussions in an attempt to amicably resolve your claim. The notice must provide your name, address, and telephone number; identify the product that is the subject of the claim; and describe the nature of the claim and the relief being sought. If you and LG are unable to resolve the dispute within 30 days, either party may proceed to file a claim for arbitration.

Agreement to Binding Arbitration and Class Action Waiver. Upon failure to resolve the dispute during the 30 day period after sending written notice to LG, you and LG agree to resolve any claims between us only by binding arbitration on an individual basis, unless you opt out as provided below. Any dispute between you and LG shall not be combined or consolidated with a dispute involving any other person's or entity's product or claim. More specifically, without limitation of the foregoing, any dispute between you and LG shall not under any circumstances proceed as part of a class or representative action. Instead of arbitration, either party may bring an individual action in small claims court, but that small claims court action may not be brought on a class or representative basis.

Arbitration Rules and Procedures. To begin arbitration of a claim, either you or LG must make a written demand for arbitration. The arbitration will be administered by the American Arbitration Association ("AAA") and will be conducted before a single arbitrator under the AAA's Consumer Arbitration Rules that are in effect at the time the arbitration is initiated (referred to as the "AAA Rules") and under the procedures set forth in this section. The AAA Rules are available online at www.adr.org/consumer. Send a copy of your written demand for arbitration, as well as a copy of this provision, to the AAA in the manner described in the AAA Rules. You must also send a copy of your written demand to LG at LG Electronics, USA, Inc. Attn: Legal Department- Arbitration 111 Sylvan Avenue Englewood Cliffs, NJ 07632. If there is a conflict between the AAA Rules and the rules set forth in this section, the rules set forth in this section will govern. This arbitration provision is governed by the Federal Arbitration Act. Judgment may be entered on the arbitrator's award in any court of competent jurisdiction. All issues are for the arbitrator to decide, except that issues relating to the scope and enforceability of the arbitration provision and to the arbitrability of the dispute are for the court to decide. The arbitrator is bound by the terms of this provision.

Governing Law. The law of the state of your residence shall govern this Limited Warranty and any disputes between us except to the extent that such law is preempted by or inconsistent with applicable federal law.

Fees/Costs. You do not need to pay any fee to begin an arbitration. Upon receipt of your written demand for arbitration, LG will promptly pay all arbitration filing fees to the AAA unless you seek more than \$25,000 in damages, in which case the payment of these fees will be governed by the AAA Rules. Except as otherwise provided for herein, LG will pay all AAA filing, administration and arbitrator fees for any arbitration initiated in accordance with the AAA Rules and this arbitration provision. If you prevail in the arbitration, LG will pay your attorneys' fees and expenses as long as they are reasonable, by considering factors including, but not limited to, the purchase amount and claim amount. Notwithstanding the foregoing, if applicable law allows for an award of reasonable attorneys' fees and expenses, an arbitrator can award them to the same extent that a court would. If the arbitrator finds either the substance of your claim or the relief sought in the demand is frivolous or brought for an improper purpose (as measured by the standards set forth in Federal Rule of Civil Procedure 11(b)), then the payment of all arbitration fees will be governed by the AAA Rules. In such a situation, you agree to reimburse LG for all monies previously disbursed by it that are otherwise your obligation to pay under the AAA Rules. Except as otherwise

provided for, LG waives any rights it may have to seek attorneys' fees and expenses from you if LG prevails in the arbitration.

Hearings and Location. If your claim is for \$25,000 or less, you may choose to have the arbitration conducted solely on the basis of (1) documents submitted to the arbitrator, (2) through a telephonic hearing, or (3) by an in-person hearing as established by the AAA Rules. If your claim exceeds \$25,000, the right to a hearing will be determined by the AAA Rules. Any in-person arbitration hearings will be held at a location within the federal judicial district in which you reside unless we both agree to another location or we agree to a telephonic arbitration.

Opt Out. You may opt out of this dispute resolution procedure. If you opt out, neither you nor LG can require the other to participate in an arbitration proceeding. To opt out, you must send notice to LG no later than 30 calendar days from the date of the first consumer purchaser's purchase of the product by either: (i) sending an e-mail to optout@lge.com, with the subject line: "Arbitration Opt Out" or (ii) calling 1-800-980-2973. You must include in the opt out e-mail or provide by telephone: (a) your name and address; (b) the date on which the product was purchased; (c) the product model name or model number; and (d) the serial number (the serial number can be found (i) on the product; or (ii) online by accessing <https://www.lg.com/us/support/repair-service/schedule-repair-continued> and clicking on "Find My Model & Serial Number").

You may only opt out of the dispute resolution procedure in the manner described above (that is, by e-mail or telephone); no other form of notice will be effective to opt out of this dispute resolution procedure. Opting out of this dispute resolution procedure will not affect the coverage of the Limited Warranty in any way, and you will continue to enjoy the full benefits of the Limited Warranty. If you keep this product and do not opt out, then you accept all terms and conditions of the arbitration provision described above.



LG

Life's Good

LG Customer Information Center

For inquiries or comments,
visit **www.lg.com** or call:

1-800-243-0000 U.S.A.

1-888-542-2623 CANADA

Register your product Online!

www.lg.com