



Birdfy

Birdfy Feeder User Manual

EN

DE

FR

ES

IT

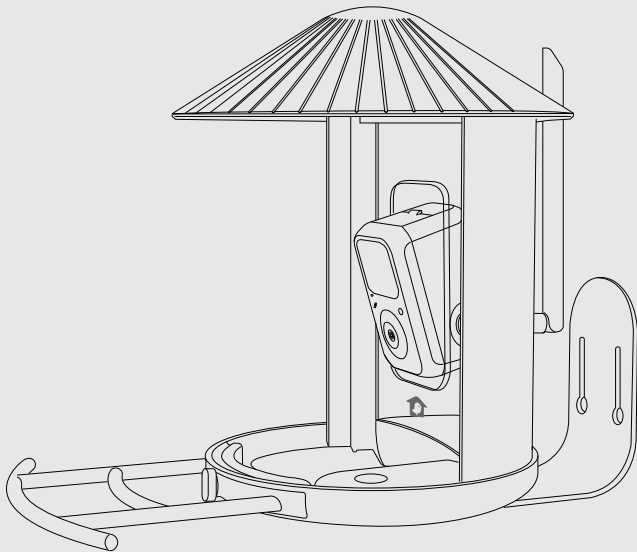

Warning

Note: This equipment has been tested and found to comply with the limits for a Class B digital device, pursuant to part 15 of the FCC Rules. These limits are designed to provide reasonable protection against harmful interference in a residential installation. This equipment generates, uses and can radiate radio frequency energy and, if not installed and used in accordance with the instructions, may cause harmful interference to radio communications. However, there is no guarantee that interference will not occur in a particular installation. If this equipment does cause harmful interference to radio or television reception, which can be determined by turning the equipment off and on, the user is encouraged to try to correct the interference by one or more of the following measures:

- Reorient or relocate the receiving antenna.
- Increase the separation between the equipment and receiver.
- Connect the equipment into an outlet on a circuit different from that to which the receiver is connected.
- Consult the dealer or an experienced radio/TV technician for help.

This device complies with part 15 of the FCC Rules. Operation is subject to the following two conditions: (1) This device may not cause harmful interference, and (2) this device must accept any interference received, including interference that may cause undesired operation.

Any changes or modifications made without explicit approval from the responsible party in compliance may result in the user being unauthorized to operate the device.

This device meets the FCC radiation exposure limits for uncontrolled environments. To ensure safe installation and operation, maintain a minimum distance of 20cm between the radiator and your body.

FCC ID: 2A08RNI-8101

CE Statement

The information provided on the packaging is allowed to identify geographical areas within the member states where restrictions on use or requirements for authorized use exist, if applicable.

The structure of the product allows it to be used in at least one member state without violating applicable requirements for the use of radio spectrum.

Manufacturer information:

NETVUE INC.

1055 East Colorado Boulevard 5th Floor
Pasadena, CA, 91106

Catalog

What's in the Box	1-4
Inserting MicroSD Card	5-7
Camera Charging	8-9
Turning the Camera On & Off	10
Pre-Installation Notes	12
AI Bird Identification	17-18

Katalog

Was ist in der Box	1-4
Einlegen der MicroSD-Karte	5-7
Kamera aufladen	8-9
Ein- und Ausschalten der Kamera	10
Vor der Installation zu beachten	13
AI Vogelidentifikation	17-18

Catalogue

Contenu de la boîte	1-4
Insertion de la carte MicroSD	5-7
Chargement de la caméra	8-9
Allumer et éteindre la caméra	10
Notes préalables à l'installation	14
Identification des oiseaux par IA	17-18

Catálogo

Qué hay en la caja	1-4
Cómo insertar una tarjeta MicroSD	5-7
Carga de la cámara	8-9
Encendido y apagado de la cámara	10
Notas previas a la instalación	15
Identificación de aves mediante IA	17-18

Catalogo

Cosa c'è nella scatola	1-4
Inserimento della scheda MicroSD	5-7
Caricamento della telecamera	8-9
Accensione e spegnimento della telecamera	10
Note pre-installazione	16
Identificazione degli uccelli tramite AI	17-18

What's in the Box



Roof
Dach
Toit
Techo
Tetto



Screws for mounting on wood
Schrauben zur Befestigung an Holz
Vis pour montage sur bois
Tornillos para montaje en madera
Viti per il montaggio su legno



Anchors
Anker
Ancres
Anclajes
Ancore



Perch screw
Sitzstangenschraube
Vis de la perche
Tornillo de la percha
Vite del posatoio

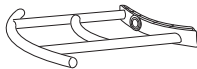

Perch
Sitzstange
Perche
Percha
Posatoio

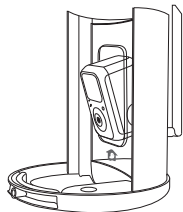

Feeder & camera
Feeder & Kamera
Distributeur & caméra
Feeder y cámara
Distributore e telecamera



Drilling template
Bohrschablone
Gabarit de perçage
Plantilla de perforación
Template di perforazione

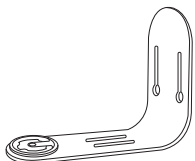

Mounting bracket
Montagehalterung
Support de montage
Soporte de montaje
Staffa di montaggio



Ejector pin
Auswerferstift
Broche d'éjecteur
Perno espulsor
Perno di espulsione

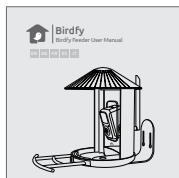

User Manual
Benutzerhandbuch
Manuel d'utilisateur
Manual del usuario
Manuale utente

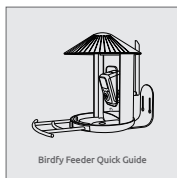

Quick Guide
Schnellstartanleitung
Guide rapide
Guía rápida
Guida rapida

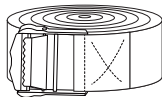

Black strap
Schwarzer Gurt
Sangle noire
Correa negra
Cinghia nera

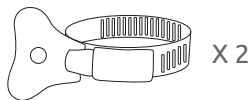

Hose clips (small)
Schlauchklemmen (klein)
Pincos de tuyau (petites)
Abrazaderas de manguera (pequeñas)
Clip per tubi (piccolo)

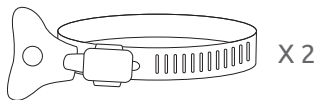

Hose clips (large)
Schlauchklemmen (groß)
Pincos de tuyau (grandes)
Abrazaderas de manguera (grandes)
Clip per tubi (grande)



Screws for mounting on concrete
Schrauben zur Befestigung an Beton
Vis pour montage sur béton
Tornillos para montaje en concreto
Viti per il montaggio su calcestruzzo

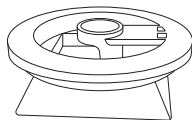

Tripod adapter
Stativadapter
Adaptateur de trépied
Adaptador de trípode
Adattatore per treppiede

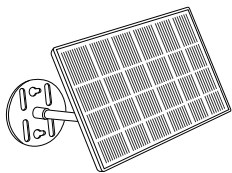

Solar panel + installation package
Solarmodul + Installationspaket
Panneau solaire + kit d'installation
Panel solar + paquete de instalación
Pannello solare + pacchetto di installazione

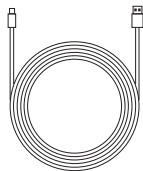

Type-C charging cable
Typ-C Ladekabel
Câble de chargement Type-C
Cable de carga Tipo-C
Cavo di ricarica Type-C

- *Please note that if you have purchased the no-solar bundle, the package will not include a solar panel.
- *Bitte beachten Sie, dass bei einem Kauf des "no-solar" Bundles das Paket keinen Solarmodul enthält.
- *Veuillez noter que si vous avez acheté le bundle sans panneau solaire, le package ne comprendra pas de panneau solaire.
- *Por favor, ten en cuenta que si has comprado el paquete sin panel solar, este no incluirá un panel solar.
- *Si prega di notare che se hai acquistato il bundle senza pannello solare, il pacchetto non includerà un pannello solare.

Inserting MicroSD Card

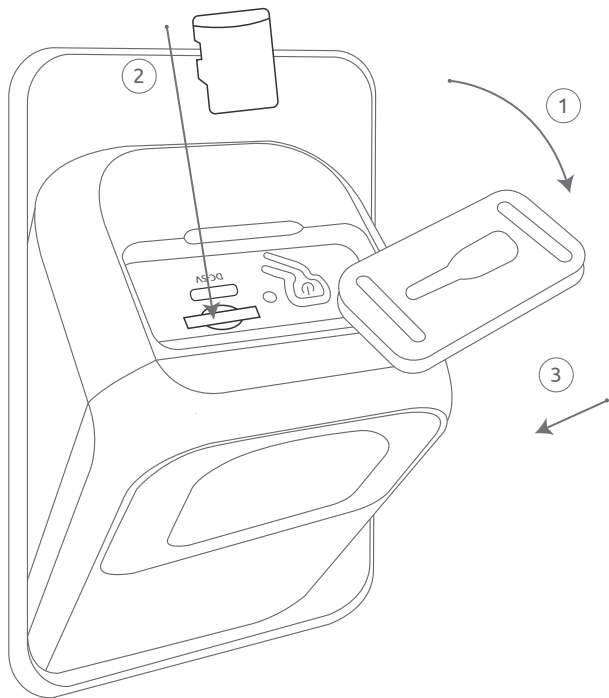

Birdfy Feeder comes with a built-in card slot which supports Class 10 microSD cards with capacities of up to 128GB.

Step 1: Rotate the camera downwards.

Step 2: Open the silicone cover and insert the microSD card. Make sure it is properly positioned with the label facing upward.

Step 3: Put back the silicone cover.

Birdfy Feeder ist mit einem eingebauten Kartensteckplatz ausgestattet, der Class 10 microSD-Karten mit einer Kapazität von bis zu 128 GB unterstützt.

Schritt 1: Drehen Sie die Kamera nach unten.

Schritt 2: Öffnen Sie die Silikonabdeckung und legen Sie die microSD-Karte ein. Stellen Sie sicher, dass sie ordnungsgemäß positioniert ist und das Etikett nach oben zeigt.

Schritt 3: Setzen Sie die Silikonabdeckung wieder ein.

Birdfy Feeder est équipé d'un emplacement pour carte intégré qui prend en charge les cartes microSD de classe 10 d'une capacité allant jusqu'à 128 Go.

Étape 1 : Faites pivoter la caméra vers le bas.

Étape 2 : Ouvrez le couvercle en silicone et insérez la carte microSD. Assurez-vous qu'elle est correctement positionnée avec l'étiquette vers le haut.

Étape 3 : Remplacez le couvercle en silicone.

Birdfy Feeder viene con una ranura para tarjeta integrada que admite tarjetas microSD de clase 10 con capacidades de hasta 128 GB.

Paso 1: Gire la cámara hacia abajo.

Paso 2: Abra la tapa de silicona e inserte la tarjeta microSD. Asegúrese de que esté correctamente posicionada con la etiqueta hacia arriba.

Paso 3: Vuelva a colocar la tapa de silicona.

Birdfy Feeder è dotato di uno slot per schede integrato che supporta schede microSD di classe 10 con capacità fino a 128 GB.

Passo 1: Ruotare la telecamera verso il basso.

Passo 2: Aprire il coperchio in silicone e inserire la scheda microSD. Assicurarsi che sia posizionata correttamente con l'etichetta rivolta verso l'alto.

Passo 3: Rimettere il coperchio in silicone.

Camera Charging

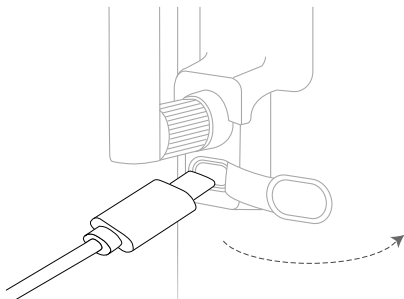

The camera does not come fully charged due to safety regulations. Before using it for the first time, please charge it for 14 hours with the charging cable inside the box (DC5V / 1A).

Status light is solid yellow: charging

Status light is solid green: fully charged

Die Kamera wird aufgrund von Sicherheitsvorschriften nicht vollständig aufgeladen geliefert. Bitte laden Sie sie vor der ersten Verwendung mit dem im Lieferumfang enthaltenen Ladekabel für 14 Stunden auf (DC5V / 1A).

Statusleuchte leuchtet konstant gelb: Aufladen

Statusleuchte leuchtet konstant grün: Vollständig aufgeladen

La caméra n'est pas entièrement chargée en raison des réglementations de sécurité.
Avant de l'utiliser pour la première fois, veuillez la charger pendant 14 heures avec le câble de chargement dans la boîte (DC5V / 1A).
La lumière d'état est jaune fixe : en charge
La lumière d'état est verte fixe : complètement chargée

La cámara no viene completamente cargada debido a las regulaciones de seguridad.
Antes de usarla por primera vez, cárguela durante 14 horas con el cable de carga dentro de la caja (DC5V / 1A).
La luz de estado es amarilla sólida: cargando
La luz de estado es verde sólida: completamente cargada

La telecamera non viene fornita completamente carica a causa delle normative di sicurezza. Prima di utilizzarla per la prima volta, si prega di caricarla per 14 ore con il cavo di ricarica incluso nella confezione (DC5V / 1A).
La luce di stato è gialla fissa: in carica
La luce di stato è verde fissa: completamente carica

Turning the Camera On & Off

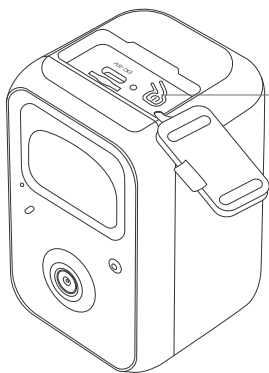

Power button
Ein-/Ausschaltknopf
Bouton d'alimentation
Botón de encendido
Pulsante di accensione

Powering on or off:

Long press the power button at the top of the camera.

Ein- oder Ausschalten:

Drücken Sie die Ein-/Aus-Taste oben auf der Kamera lange.

Mise en marche ou arrêt :

Maintenez enfoncé le bouton d'alimentation situé en haut de la caméra.

Encendido o apagado:

Mantén presionado el botón de encendido en la parte superior de la cámara.

Accensione o spegnimento:

Tieni premuto il pulsante di accensione in cima alla telecamera.

Pre-Installation Notes

1. Keep Birdfy Feeder and all accessories out of the reach of children and pets.
2. Make sure the camera is fully charged (DC5V / 1A).
3. Working temperature: -10°C to 50°C (14°F to 122°F)
Working relative humidity: 0-95%
4. Please avoid exposing the camera lens to direct sunlight.
5. The camera has an IP65 waterproof rating, which allows it to function properly in rainy or snowy conditions. However, it should not be submerged in water.

Note:

1. Birdfy Feeder only works with 2.4GHz Wi-Fi.
2. Strong light may interfere with the device's ability to scan QR codes.
3. Avoid placing the device behind furniture or near a microwave oven. Please try to keep it in the range of your Wi-Fi signal.

Vor der Installation zu beachten

1. Halten Sie Birdfy Feeder und alle Zubehörteile außerhalb der Reichweite von Kindern und Haustieren.
2. Stellen Sie sicher, dass die Kamera vollständig aufgeladen ist (DC5V / 1A).
3. Arbeitstemperatur: -10°C bis 50°C (14°F bis 122°F)
Arbeitsluftfeuchtigkeit: 0-95%
4. Bitte vermeiden Sie direkte Sonneneinstrahlung auf das Kamerobjektiv.
5. Die Kamera verfügt über eine IP65-Wasserdichtigkeitsbewertung, die es ihr ermöglicht, auch bei Regen oder Schneefall ordnungsgemäß zu funktionieren. Sie darf jedoch nicht ins Wasser getaucht werden.

Hinweis:

1. Birdfy Feeder funktioniert nur mit 2.4-GHz-WLAN.
2. Starke Lichtquellen können die Fähigkeit des Geräts zur Erkennung von QR-Codes beeinträchtigen.
3. Vermeiden Sie es, das Gerät hinter Möbeln oder in der Nähe einer Mikrowelle zu platzieren. Versuchen Sie, es im Bereich Ihres WLAN-Signals aufzustellen.

Notes préalables à l'installation

1. Gardez Birdfy Feeder et tous les accessoires hors de portée des enfants et des animaux domestiques.
2. Assurez-vous que la caméra est complètement chargée (DC5V / 1A).
3. Température de travail : -10°C à 50°C (14°F à 122°F)
Humidité relative de travail : 0-95%
4. Évitez d'exposer l'objectif de la caméra à la lumière directe du soleil.
5. La caméra a une cote d'étanchéité IP65, ce qui lui permet de fonctionner correctement par temps de pluie ou de neige. Cependant, elle ne doit pas être immergée dans l'eau.

Noter :

1. Birdfy Feeder ne fonctionne qu'avec le Wi-Fi 2.4 GHz.
2. Une forte lumière peut perturber la capacité de l'appareil à scanner les codes QR.
3. Évitez de placer l'appareil derrière des meubles ou à proximité d'un four à micro-ondes.
Essayez de le garder dans la portée de votre signal Wi-Fi.

Notas previas a la instalación

1. Mantenga Birdfy Feeder y todos los accesorios fuera del alcance de niños y mascotas.
2. Asegúrese de que la cámara esté completamente cargada (DC5V / 1A).
3. Temperatura de trabajo: -10°C a 50°C (14°F a 122°F)
Humedad relativa de trabajo: 0-95%
4. Por favor, evite exponer la lente de la cámara a la luz solar directa.
5. La cámara tiene una clasificación de impermeabilidad IP65, lo que le permite funcionar adecuadamente en condiciones de lluvia o nieve. Sin embargo, no debe sumergirse en agua.

Nota:

1. Birdfy Feeder solo funciona con Wi-Fi de 2.4 GHz.
2. La luz fuerte puede interferir con la capacidad del dispositivo para escanear códigos QR.
3. Evite colocar el dispositivo detrás de muebles o cerca de un horno de microondas.
Por favor, trate de mantenerlo dentro del alcance de su señal Wi-Fi.

Note pre-installazione

1. Tenere Birdfy Feeder e tutti gli accessori fuori dalla portata dei bambini e degli animali domestici.
2. Assicurarsi che la telecamera sia completamente carica (DC5V / 1A).
3. Temperatura di lavoro: -10°C a 50°C (14°F a 122°F)
Umidità relativa di lavoro: 0-95%
4. Evitare di esporre l'obiettivo della telecamera alla luce solare diretta.
5. La telecamera ha una valutazione di impermeabilità IP65, che le consente di funzionare correttamente in condizioni di pioggia o neve. Tuttavia, non deve essere immersa in acqua.

Nota:

1. Birdfy Feeder funziona solo con Wi-Fi a 2.4 GHz.
2. Una forte luce può interferire con la capacità del dispositivo di scansionare i codici QR.
3. Evitare di posizionare il dispositivo dietro i mobili o vicino a un forno a microonde. Si prega di cercare di mantenerlo nell'area di copertura del segnale Wi-Fi.

AI Bird Identification

If you bought the Birdfy Feeder AI, this feature is included and activated automatically, without any additional cost.

If you have the Birdfy Feeder Lite, you need to subscribe to access this feature.

With AI Bird Identification, you can find out in real-time which bird species are visiting your feeder.

Wenn Sie den Birdfy Feeder AI gekauft haben, ist diese Funktion automatisch und ohne zusätzliche Kosten aktiviert.

Wenn Sie den Birdfy Feeder Lite haben, müssen Sie ein Abonnement abschließen, um auf diese Funktion zugreifen zu können.

Mit der KI-Vogelidentifikation können Sie in Echtzeit herausfinden, welche Vogelarten Ihren Feeder besuchen.

Si vous avez acheté le Birdfy Feeder AI, cette fonctionnalité est incluse et activée automatiquement, sans frais supplémentaires.

Si vous avez le Birdfy Feeder Lite, vous devez vous abonner pour accéder à cette fonctionnalité.

Avec l'identification des oiseaux basée sur l'IA, vous pouvez savoir en temps réel quelles espèces d'oiseaux visitent votre mangeoire.

Si ha comprado el Birdfy Feeder AI, esta función está incluida y se activa automáticamente, sin costo adicional.

Si tiene el Birdfy Feeder Lite, necesita suscribirse para acceder a esta función.

Con la Identificación de aves basada en IA, puede descubrir en tiempo real qué especies de aves visitan su comedero.

Se hai acquistato il Birdfy Feeder AI, questa funzione è inclusa ed attivata automaticamente, senza costi aggiuntivi.

Se hai il Birdfy Feeder Lite, devi sottoscrivere un abbonamento per accedere a questa funzione.

Con l'Identificazione degli uccelli basata su IA, puoi scoprire in tempo reale quali specie di uccelli visitano il tuo distributore.



Learn more on www.birdfy.com



Contact us at:



support@birdfy.com



In-App Chat



1(886)749-0567

Mon-Fri, 9am-5pm, PST



@birdfy by netvue

www.birdfy.com
© Netvue Inc.

