

QUICK SETUP GUIDE

FlexView Case for 7", 8", and 10" Tablets

This protective case features a locking plate that securely holds your tablet in place, yet allows it to be easily removed. Your tablet will be protected from scratches and other damage with this stylish cover.

PACKAGE CONTENTS

- Protective case
- *Quick Setup Guide*

FEATURES

- Simple and universal protection for your tablet
- Durable and convenient
- Adjustable corners to secure your tablet
- Flexible viewing in portrait and landscape modes

Before using your new product, please read these instructions to prevent any damage.

INSTALLING YOUR TABLET

1 Insert the tablet into the inside corners of the case.

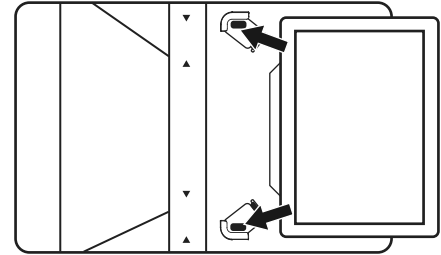

2 Snap the outside corners around the corners of the tablet.

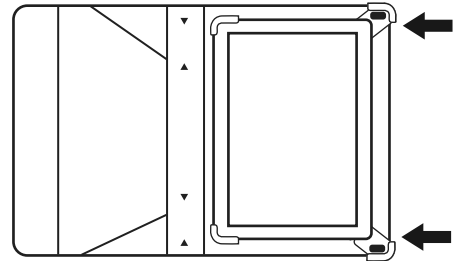

USING YOUR PROTECTIVE CASE AS A STAND

1 With the cover open and laying flat, lift the inside edge of the tablet mount.

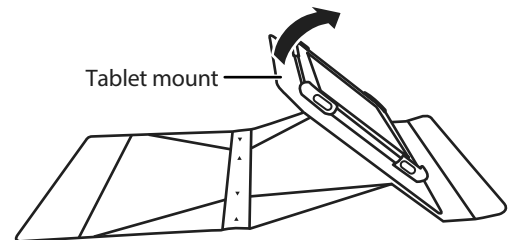

- 2** Fold in the right and left edges of the outside of the cover, then attach the outer, magnetic edge of the cover to the top of the tablet mount, forming a rigid stand on the back side of the tablet mount.

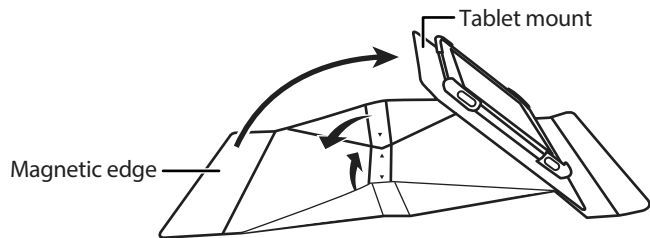

- 3** Fold under the bottom edge of the cover.

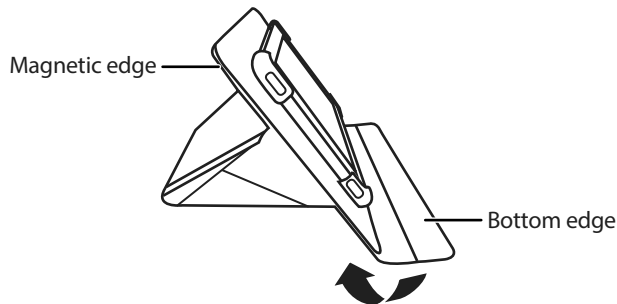

- 4** Select your viewing orientation.

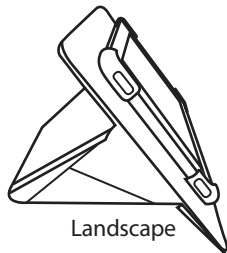

OR

- Turn the base of the case to select the portrait viewing orientation.

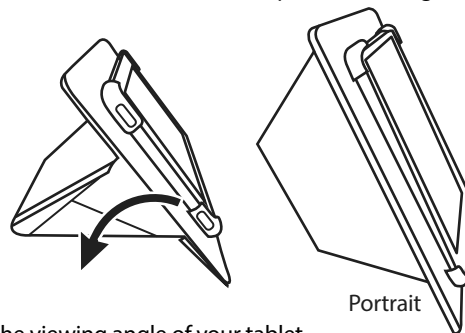

- 5** Adjust the viewing angle of your tablet.

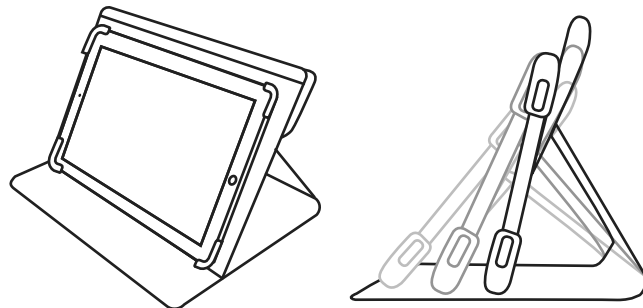

ONE-YEAR LIMITED WARRANTY

Visit www.insigniaproducts.com for details.

CONTACT INSIGNIA:

For customer service, call 1-877-467-4289 (U.S. and Canada) or 01-800-926-3000 (Mexico)
www.insigniaproducts.com

INSIGNIA is a trademark of Best Buy and its affiliated companies. Distributed by Best Buy Purchasing, LLC, 7601 Penn Ave South, Richfield, MN 55423 U.S.A. ©2019 Best Buy. All rights reserved. **Made in China**