

AKICON

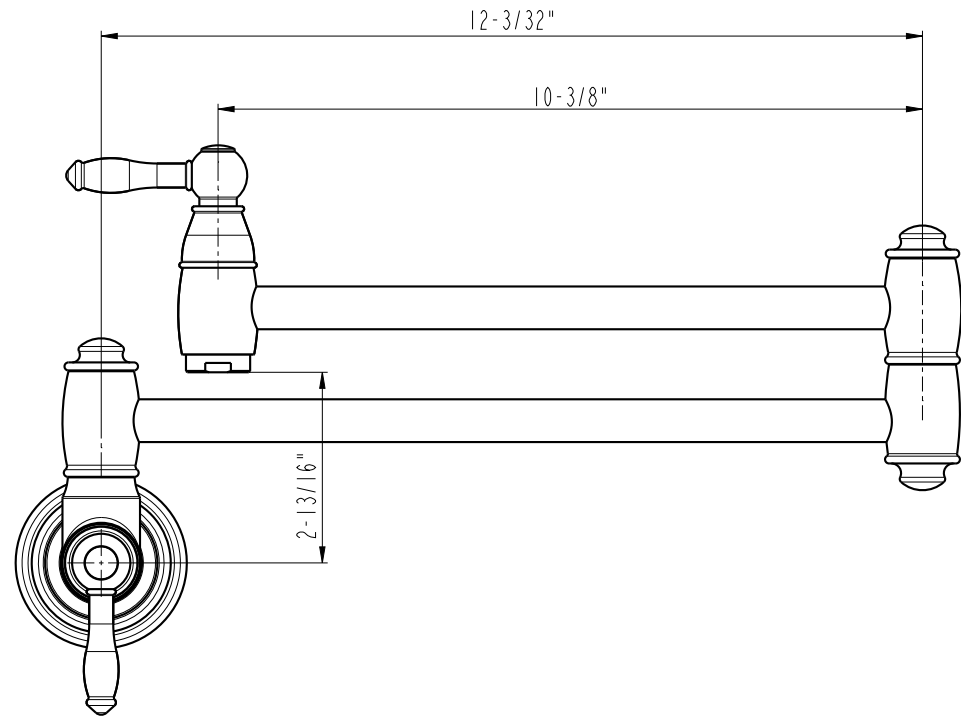

98288-Dimensional drawing

17 Turn on the water supply to the faucet and check for leaks.

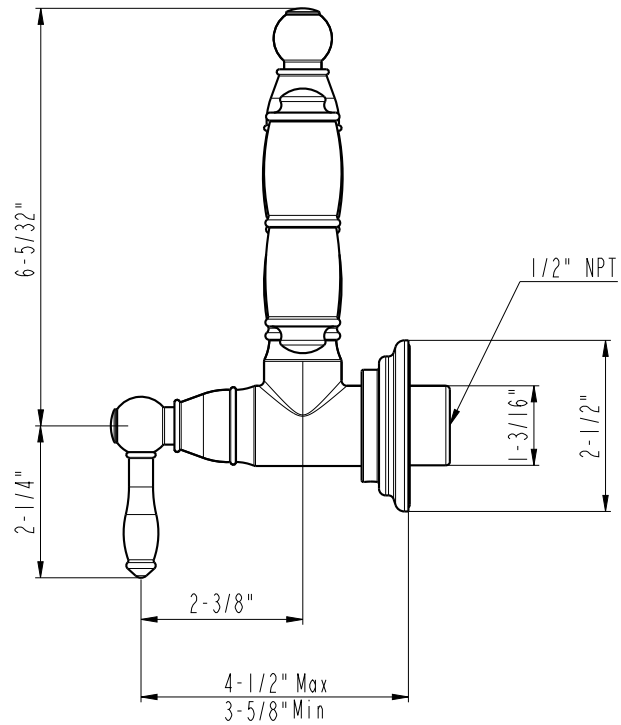
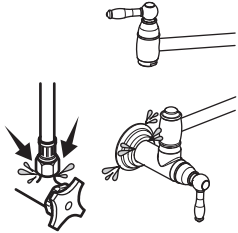

18 Remove the aerator and open both handles to flush debris from the faucet.

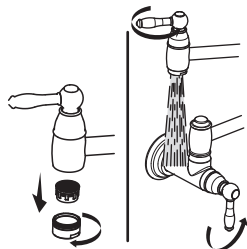

19 Turn off the water and reinstall the aerator.

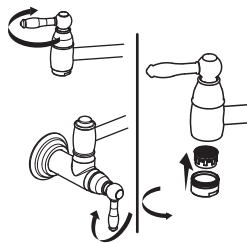

CAUTION: Maintenance

1. Replacement parts may be available at the store where you purchased your faucet.
2. Always turn off water and relieve pressure before working on your faucet.

NOTES: Cleaning Instructions

1. To keep the faucet clean, you should clean the faucet frequently and regularly.
2. Clean the faucet with clear water or mild liquid, rinse the faucet with clear water and then dry the faucet with soft cotton cloths.
3. Do not use any abrasive cleansers, cloths, or paper towel.
4. Do not use any acid or abrasive detergent.

TROUBLE-SHOOTING

If you've followed the instruction carefully and your faucet still does not work properly, take these corrective steps.

Problem	Cause	Action
Leaks underneath handle.	Cartridge has come loose.	Tighten the cartridge.
Aerator leaks or has an inconsistent water flow pattern.	Aerator is dirty or worn out or misfitted.	Unscrew the aerator to clean or replace washer, or replace the aerator.
Water will not shut off completely.	Dirty or worn out washer in cartridge.	Remove handle and cartridge to check if the washer is damaged permanently or dirty. Re-install cartridge.

AKICON

Wall-Mount Pot Filler Faucet

PACKING LIST

After you open this package, please check to ensure that all of the following items are included.

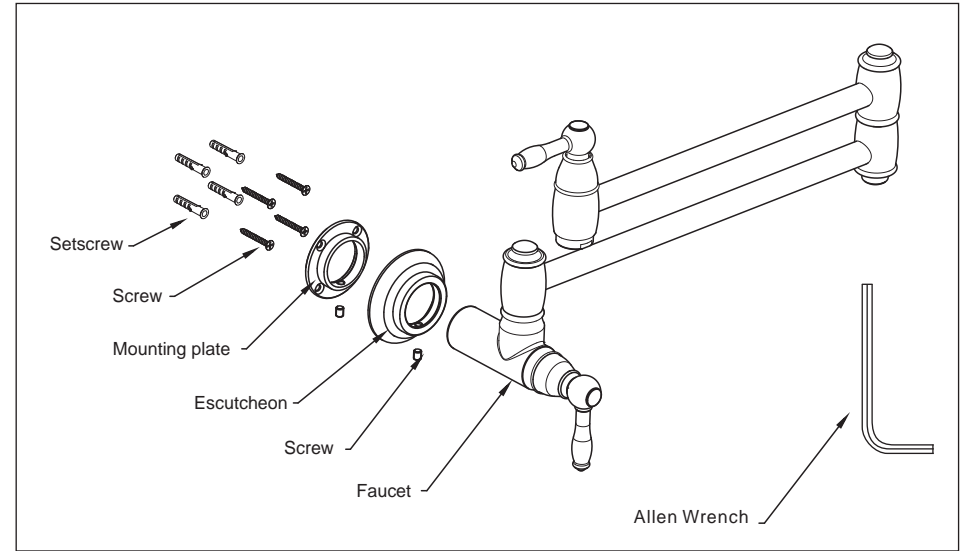

IMPORTANT NOTICES: Do not use petroleum-based products in this faucet. Observe all local plumbing and building codes.

YOU MAY NEED

Common woodworking and plumbing tools and materials

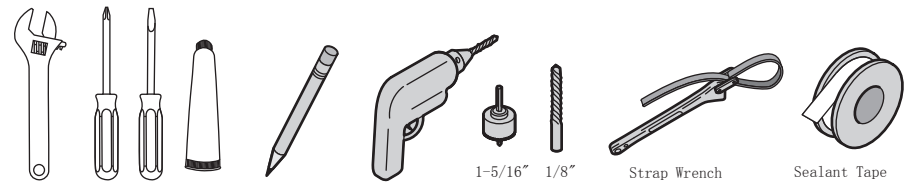

Questions, problems, missing parts?
 call Akicon Customer Service 8 a.m.-6p.m. EST, Monday-Friday
 Phone: +1(302)213 4406, Email: service@akicon.com
 AKICONHVAC.COM

INSTALLATION PROCEDURES

1

Install 2x4 backing flush with the studs, at the installation location.

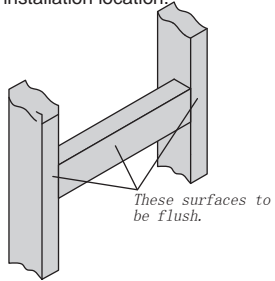

3

Secure the supply pipe to the 2x4 backing.

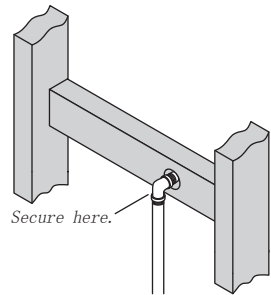

5

Slide the mounting plate on the faucet shank. Tighten the setscrew into the groove.

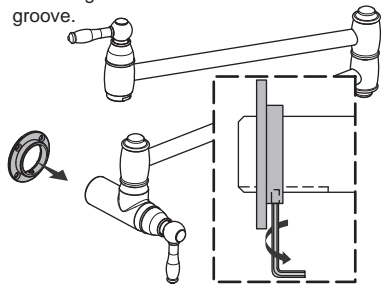

7

Mark the four screw hole locations with the setscrew down.

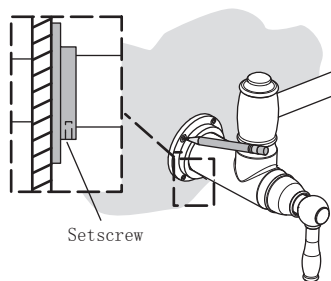

2

Install a 1/2" NPT supply pipe to extend no more than 1/2" (13mm) beyond the wall.

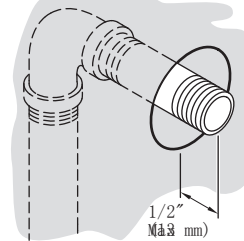

4

Complete the finished wall. Provide a 1-5/16" (33 mm) hole around the supply pipe.

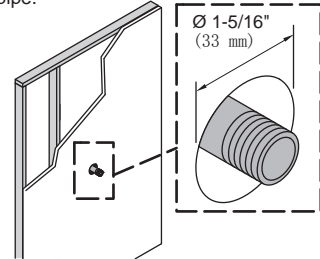

6

Thread the shank to the supply pipe so the mounting plate is flush.

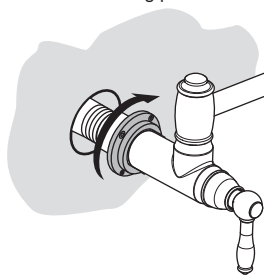

8

Remove the faucet from the supply pipe. Remove the mounting plate from the shank.

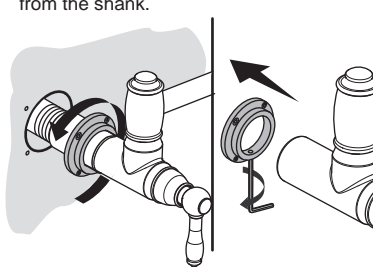

9

Drill four 1/8" holes at the marked locations.

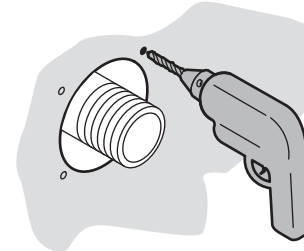

11

Position the mounting plate over the holes with the setscrew hole down. Secure with the screws.

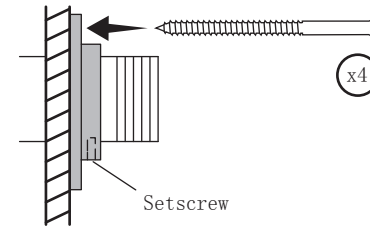

13

Use a strap wrench to secure the faucet to the supply pipe.

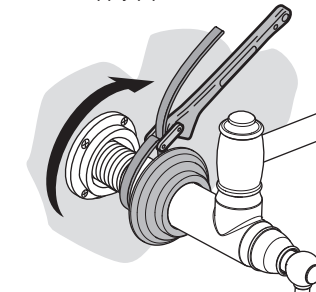

15

Slide the escutcheon against the wall with the setscrew down. Tighten the setscrew.

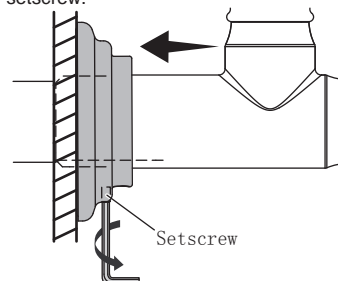

10

Apply thread sealant to the supply pipe.

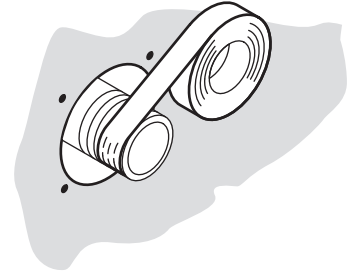

12

Slide the escutcheon onto the shank.

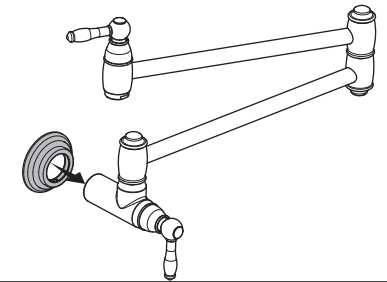

14

Align the faucet groove with the setscrew hole in the mounting plate. Tighten the setscrew.

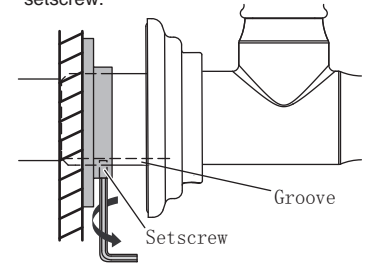

16

Turn both handles fully clockwise to the off position.

