

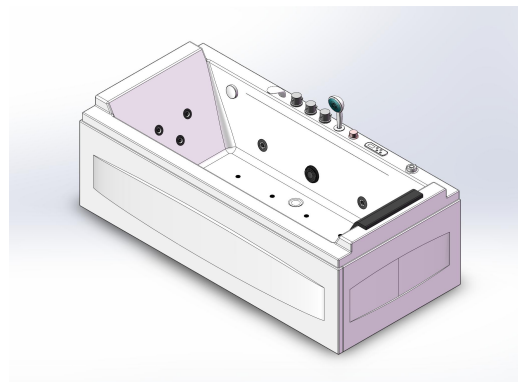

MESSAGE BATHTUB

MODEL: EMPV-71JT351-BK



Introduction

you for choosing our massage bathtub series. We provide a 3 years warranty after-sale service upon purchase of our products. If you need any assistance during this process, please contact a local distributor or our company directly.

To use our products safely and effectively, please read these instructions carefully. Improper installation, operation, or maintenance will cause damage to the products and will result in an additional repair fee.

Please note that we reserve the right to change this manual without prior notice.

Due to the difference between general market requirement and our individual custom product, please refer to the corresponding content in this manual according to the chosen product and its functions. By doing so, you can correctly install and operate the product according to its specific features.

- In order to correctly install and maintain the product, please pay special attention to the warning sign below.

Notice This symbol indicates that errant handling after disregarding this symbol could result in personal injury or property loss.

- In order to install, use, and maintain this product correctly and safely, please read these instructions thoroughly.

- This manual is a valuable source of product information to help the user handle the product safely and correctly. Please put it in a safe place where it cannot be lost or soiled.

Preparation before installation

- Make sure the area in which you install the bathtub is strong enough to bear the total weight of the bathtub, maximum water volume, and the user.
- The installation area must be waterproofed, otherwise the downstairs area below the bathtub will get damaged if water leaks.
- The installation area must be equipped with water supply, power supply, and drainage:

Notice External circuitry is equipped with high sensitive and fast type leakage protection switch. (Induced current rating below 15mA; trip time should be less than 0.1 second; rated current is above 30A.)
*The product should be installed alongside ground and electric leakage switches by a licensed electrician.

- Please reserve a drainage hole the size $\geq \varnothing 50\text{mm}$ (1.97 inch) to make sure the drainage pipes accord with the water valve.
- The user needs to reserve the connectors of 1/2" external thread cold/hot water hoses, which outstand the wall 30mm (1.18 inch). It is suggested to install a valve in each pipe; these installation locations should be designed by the user so as to allow them to properly maintain it.
- Because each bathroom or bathtub's power and drain are slightly different, please place the bathtub in an optimal location according to its surroundings. The following illustration may be used as a reference layout:

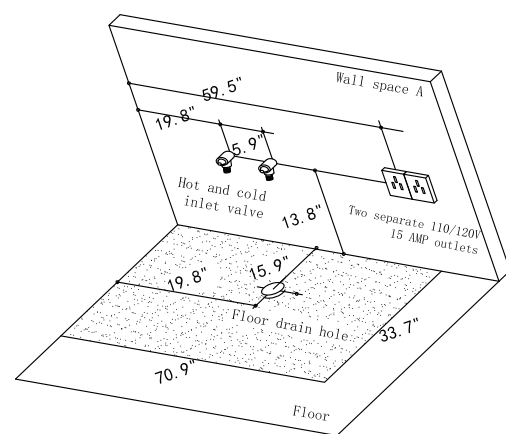

Notice The safe distance between power supply and water supply should be at least 30cm (11.8 inch).

Inspection Before Installation

- Be careful when removing the bathtub from its packaging so as to avoid contact with any harsh surfaces. Remove the staples or fold them into the box. Additionally, it is advisable to lift the bathtub by its rim during handling to minimize any risk of damage. Retain the packaging box until the satisfactory installation of the product has been ensured.
- Conduct a thorough inspection of the bathtub components and skirts. In the event that any damage or defect is detected in the nish, refrain from installing the bathtub. Please note that any damage or defect claimed after installation is not covered by the warranty. The responsibility for shipping damage terminates once the carrier has delivered the products in good order.
- Any claims for damage should be referred to the carrier. For a comprehensive understanding of the warranty coverage and its limitations, please refer to the published three-year warranty section in this manual.

Before beginning your installation, please take note of the following guidelines:

- Compliance with all local and building codes is mandatory.
- Determine the necessary tools required for the installation.
- Install drain/overrow per the manufacturer's instructions and the Technical Specifications Manual. It is the installer's responsibility to ensure a water-tight installation of the drain. Any drain leakage is not covered by the bathtub warranty.
- Install the faucet and shower head at this stage (if applicable). It is recommended that a qualified plumber installs the faucet. Please see additional notes on freestanding section for faucets.

- It is the installer's responsibility to properly install the spout plumbing and ensure compliance with local codes.
- We do not warrant connections of water supply things and piping systems, or drain/overrow systems. Neither are we responsible for any bathtub damage that occurs during the installation process.
- Additional bathtub drain parts and plumbing are commercially available at plumbing and hardware stores.
- A non-ammable protective barrier must be placed between the bathtub unit and any soldering work to prevent bathtub damage.

Notice Please check whether all parts are intact. Please contact our company with any concerns or questions.
After inspection, immediately dispose of unneeded packaging. If left, this packaging may cause injury from any carelessly placed wooden frames, nails, cardboard, or sealing straps.
In addition, please do not let children play with the packing material.

Notice This equipment is designed for indoor use only. Use supply wires that are suitable for 167°F (75°C), including the temperature rating of the supply conductors to be used. This unit should be electrically grounded and installed by a licensed contractor, electrician, and plumber.
Parts containing live elements (except parts supplied with safety extra-low voltage not exceeding 12 V) must be inaccessible to a person in the bath.
Earthed appliances must be permanently connected to fixed wiring. The terminal compartment includes a green-colored terminal or a wire connector marked with "G", "GR", "GROUND", or "GROUNDING". To reduce the risk of electric shock, connect the terminal or connector to the grounding terminal of your electric service or supply panel with a conductor equivalent in size to the circuit conductors supplying the equipment.
Parts incorporating electrical components (except remote-controlled devices) must be located and fixed so that they cannot fall into the bath.
With the exception of specified power, please do not use alternate power. This can cause fire or electric shock.

Notice An electrical leakage protection switch should be installed outside the bathroom. If this switch is not installed, fire or electric shock can occur.
Do not use a broken power supply, power plug, or the loose socket. These may cause fire or electric shock.
Do not modify the power supply cord. Also avoid using it with an extension cord or combining it with other equipment using multiple plugs. Doing so could lead to shocks, overheating, or fire.
Please make sure the power is connected to the terminal box and it requires two separate 15A Dedicated GFCI Circuits.
Building materials and wiring should be routed away from the motor/pump or blower or other heat-producing components of this unit. A pressure wire connector is provided on the exterior of the motor/pump and heater to permit connection of a No. 8 AWG solid copper bonding conductor between this unit and all other electric equipment and exposed metal in the vicinity, as necessary to comply with local regulations.

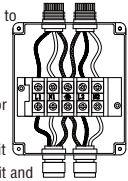

Notice Before the installation is completed, please use cardboard to protect the bathtub from damage.
Do not use open flames in the bathtub (such as a lighted cigarette) or this could damage the bathtub.
Do not stand on the bathtub while working. Doing so could cause one to slip and fall or could otherwise damage the product.
Install securely in accordance with the Installation Manual. Improper installation can lead to water leaks that damage or ruin household property.
After the installation is completed, the product should undergo trial operation to ensure that it has been installed properly.

Size chart

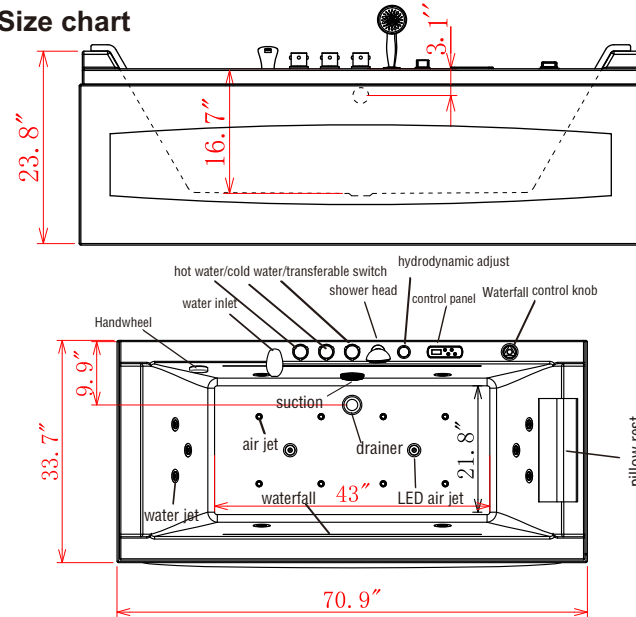

Installation instruction

Testing Before Installation

there may be some loose hose connections due to transport. You should water test the product again before installation. The steps are as follows:

- Place the tub on a surface in an area where it may be drained after testing. Adjust the feet to make the bathtub level.
- Check if anything is loose within the connection system.
- Fill the tub with water to the overflow and allow it to sit for 10 minutes. During this time, inspect the tub for leaks.
- Inspect all joints visually for any signs of leaks. If any leaks are detected, do not proceed with the installation of the bathtub.
- Insert the plug, turn on all functions for a few minutes (i.e., massage, air bubble, waterfall, and other features), and inspect the tub completely. Any defect must be reported to your dealer/distributor prior to installation in order to have it covered under warranty.

Adjust the leveling feet

We designed several leveling feet to adjust the bathtub. Please use a wrench or level ruler to level the bathtub.

Notice: If the bathtub is not level, it may lead to

- noise increase
- excess water in the hoses or the drainage
- bathtub shaking

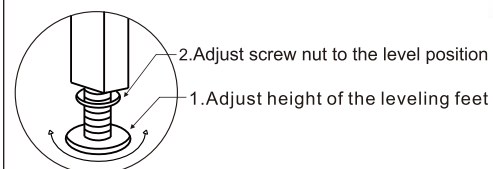

Installation instruction

How to connect the water?

For ease of use, our bathtub is equipped with stainless steel cold and hot water hoses (connector \varnothing 1/2"). Please connect the cold and hot water hoses to the bathroom's cold and hot water hoses accordingly.

Before connect bathtub water inlet pipe, first open water pipe for a period of time, then put filter screen to ensure that the debris will not enter the bathtub pipe. So that we can effectively extend the life of the fitting.

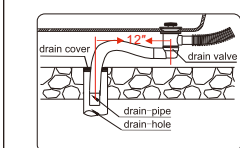

The drain pipe is 31.5" long and the ground drain should be 12" - 20" away from the bathtub drain so that the drainpipe can form an S-bend for odor isolation
Insert the drain-pipe to the drain-hole on the floor, and then cover it with water retaining cover to prevent waste water spilling.

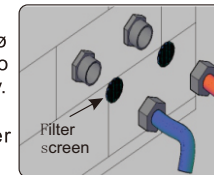

Notice The red hose is the hot water hose, and the blue hose is the cold water hose. The drain-pipe should be installed with a slope above 1:50.
Notice: Do not hold the drain-pipe and cold/hot water hoses when moving the bathtub, and do not crash it with hard objects.

How to connect the electricity?
User needs to purchase two separate 110/120V 15amp plugs and install the proper dedicated plug with a ground electrode to the power line. Then insert the plug firmly.
Note: This product uses universal home power. External circuitry is equipped with high sensitive and fast type leakage protection switch. (Induced current rating below 15MA; trip time should be less than 0.1 second; rated current is above 30A.)

Notice The product should be installed alongside ground and electric leakage switches by a licensed electrician.

Make sure the ground is connected. One side of the ground should be connected to the ground terminal of the motor and the stainless steel frame; the other side should be connected to the ground wires of the plug.

Notice The bathtub must be connected to the ground. The power outlet must be sealed well. Make sure the surface of each wire is intact.

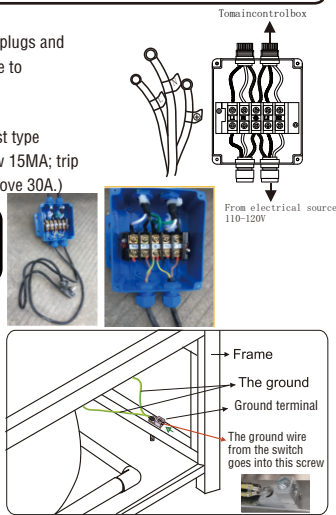

Precautions for use

Please refer to the model and configuration you have chosen when using the product.
Use this unit only for its intended use as described in this manual. Do not use attachments not recommended by the manufacturer. Do not tamper with user-operated controls or any similar devices.
Do not immerse the control panel by overflowing the bath.

To avoid injury, exercise caution when getting in and out of the hydro massage bathtub. Cleaning and user maintenance shall not be performed by children without supervision.
Do not permit children to use this unit unless an adult closely supervises them at all times. Supervision is also required when an elderly or handicapped individual uses the whirlpool bath. During the early months of pregnancy, pregnant or possibly pregnant women should consult a physician before using. Excessive water temperatures have a high potential for causing fetal damage. People with a medical histories of heart disease, low or high blood pressure, circulatory system problems, or diabetes should consult a physician before using a whirlpool.
The use of drugs or alcoholic beverages before or during whirlpool use may lead to unconsciousness with the possibility of drowning.
The water in a whirlpool should never exceed 104°F (40°C). Water temperatures between 100°F (38°C) and 104°F (40°C) are considered safe for a healthy adult. Prolonged immersion in hot water may lead to HYPERTHERMIA, so the use time should be limited to approximately 30 minutes, followed by a shower to cool down. Lower water temperatures are recommended for extended use (exceeding 10-15 minutes) and are highly recommended for younger children. If you become nauseous, dizzy, or develop a headache, get out at once and

become nauseous, dizzy, or develop a headache, get out at once and cool down. Get medical attention if symptoms persist. Check with a physician before using whirlpool again.
Persons using medication should consult a physician before using a whirlpool. Medication may induce drowsiness or affect heart rate, blood pressure, and circulation.

Notice Do not operate this unit without the suction cover over the suction fitting. Keep body and hair a minimum of 6" (152 mm) away from the suction fitting at all times when the pump is running.
Do not use a hydro massage bathtub equipped with a heater immediately following strenuous exercise.
Never drop or insert any object in any opening within the whirlpool. Never operate electrically connected devices in or near the bath. No electric appliances (i.e., hair dryer, lamp, telephone, radio, television, etc.) should be within 5 feet (1.5 meters) of this bathtub.

This bathtub is designed for "fill and drain" use, which means the bathtub needs to be drained after each use and refilled with fresh water for the next bath. This is a health precaution, as these bathtubs are not designed to hold water continuously, like pools or spas.
Close the drain and fill the bathtub until water is at least 1" to 2" (25 mm to 51 mm) above the highest jet or air inlet (as indicated by water line in the right diagram). Do not turn on the Whirlpool or Air system at any time if the jets or air inlets are not fully immersed in water. Doing so may cause water to spray outside the bathtub area.



When exiting the bathtub, the water level will drop below the jets, resulting in water to spray out of the unit. To prevent this, you must turn the unit OFF before exiting the bathtub.

● SNY-371 Control panel operation:

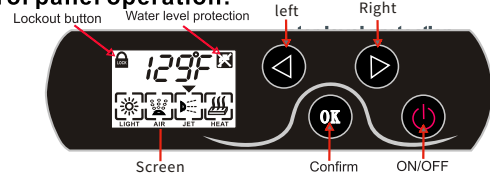

Operation :

1. ON/OFF : insert the plug ,press to switch on the power .The screen will show the temperature of water and the lamp will light up.You can perform setting and operation of various function according to the requirement of users.The system can be directly switch off by pressing .

2. Surfing function :

Press "" or "" to select the lamp icon ,as shown to the right:

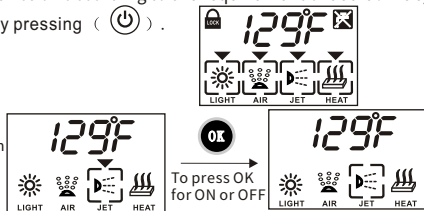

Notice : The water pump is limited by water level ,it only be launched under the condition of water level .If short of water ,the will flicker ,water pump can not start .The pump will be turned off automatically every 60 minutes .

3. Heating function :

Press "" or "" to select the heating icon , as shown to the right:



Notice : only under the surfing function on ,the heating function can be launched ,and control by the preset temperature . Default 40°C . When the water temperature reach to the preset temperature ,it will turn into constant temperature .

4. Bubble bath function : (It will be turned off automatically every 60minutes .)

Press "" or "" to select the bubble bath icon ,as shown to the right :



6. Lamp : when power on ,it will light up ,and when power off ,it will light off .

Press "" or "" to select the lamp icon ,as shown to the right:



Notice: It will light up when the power on ,only power off can light off the lamp .The above only can change the color .

(red → blue → green → seven color allochroism → white)
it will change the color each time you press OK

	The light will illuminate and change colors automatically when the control panel is turned on. Press OK to change different light colors.
	In the event of a water shortage(below the minimum water level), it will be indicated by a flashing icon and water pump will be unable to operate .
	The pump will turn off automatically every 60 minutes.
	The air bubbles will turn off automatically every 60 minutes.

	The heater is equipped with a preset vacuum switch that prevents it from activating if the pump is not running and water is not flowing through the whirlpool system. As a result, only when water jets are on, the heating function can be activated, and the temperature can be adjusted accordingly. The heater will only function when the water temp is 77°F or higher. It is recommended to fill the bathtub with warm water to ensure that the heater can function as intended. When the water temperature reaches 104°F (40°C), the inline heater will automatically shut off.
	Automatic keyboard locking : If no action on the keyboard for 2 minutes, icon will appear on the screen, indicating that the keyboard is locked automatically. Please press OK to unlock the keyboard.

Three piece three-jaw set faucet:
A. Hot water switch(Marked with letter H)
B. Cold water switch(Marked with letter C)
C.Switch (Marked with Icon of water inlet and shower head)

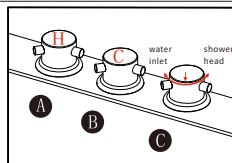

● Multi-function handheld shower with back flow protector.

Rotate the shower head shell can adjust the water pattern as follow:
-inner water column
-middle water column
-external water column

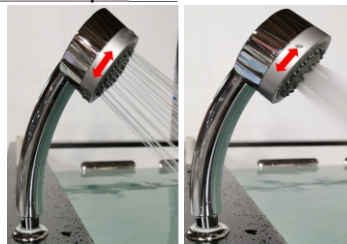

SHOWER INSTALLATION

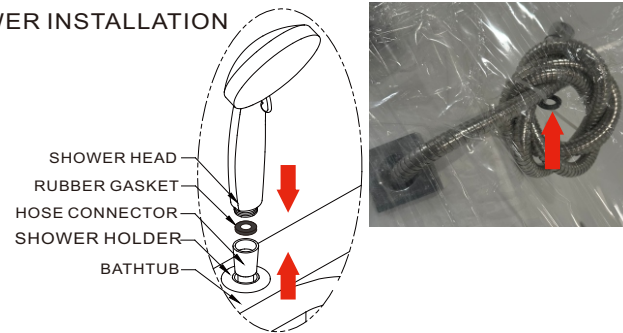

SHOWER HEAD INSTALLATION

making sure it lies flat.o install the shower head, follow the steps shown in Figure A.

First, remove the hose connector from the shower holder. Then, insert the rubber gasket into the hose connector, Finally, tighten the shower head and the hose connector securely.

● Water jets use:

Turning the head of water jets up, down, left or right can adjust the angle of inflow.



Small water jets

Hydro massage flow rate control switch



Rotate hydro massage flow rate control switch clockwise, then the water column strength smaller; rotate the knob anticlockwise, then the water column strength stronger. (Only for the model with hydro massage flow rate control switch)

● Drainage

1.Manual drainage

Rotate the cover clockwise to close the drain;
Rotate the cover anticlockwise to open the drain;
When the water is over the maximum water level, the excess water will be drained by overflow.

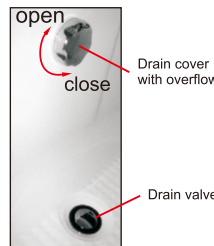

Care and Maintenance

Regular bathtub maintenance will keep it clean and working at its best. Pump and pipe circulation systems should be flushed before first use and on a monthly basis when product is under normal use. Below is the recommended cleaning procedure:

- 1.Do not run the jet massage system dry.
- 2.Fill the tub with hot water (about 40°C) 2-3 cm (0.9-1.2 inch) above the jets. Add 2-3 teaspoons of low foaming detergent, such as dishwashing machine detergent.
- 3.Turn on all the functions and run for 10 minutes.
- 4.Drain tub completely.
- 5.Fill tub with cold water above jets.
- 6.Turn on all the functions and run for 15 minutes.
- 7.Drain tub completely.
- 8.Clean the "suction cover" by removing any hair or lint.

Whirlpool Suction Cover/Strainer

Maintain regular cleaning of the suction cover/strainer

1. Rotate the suction cover to the left to detach it.
2. Remove any hair, lint, or debris present on the cover and housing.
3. Remember to reattach the cover in place.

WARNING! Please orient the cover/strainer with the small notch at the bottom. The gasket must be inserted into the groove of the cover/strainer before mounting it onto the suction fitting.

DANGER: RISK OF SEVERE INJURY OR DROWNING!

- a. Keep hair a minimum of 6 inches (152 mm) away from the suction fitting at all times when the whirlpool system is operating. Individuals with shoulder-length hair should secure it close to their heads or wear a bathing cap.
- b. Do not operate the Whirlpool system with the suction cover/strainer removed! It is a safety device and must always be in place on the suction fitting to minimize the

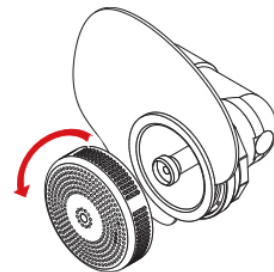

potential hazard of hair and body entrapment.



Notice

Always implement countermeasures that help prevent freezing. You must empty the bathtub and the water in the pipe during winter use. If the pipes freeze, the pipes could rupture or equipment could become damaged.

Use no water other than standard tap water. The use of well water could cause corrosion, which could lead to leaks.

The bathtub should not be exposed to ultraviolet or bright light, otherwise aging could be accelerated, causing damage.

Keep the bathtub away from cigarette butts, hair dryers, and other heat sources, otherwise the product may be damaged due to high temperature deformation.

When not in use, please keep the bathtub well-ventilated and dry; avoid contact with corrosive substances; cut off electricity and cut off water supply.

To avoid other damage, please do not drop or strike the bathtub with hard objects. Doing so could crack or scratch the bathtub or cause leaks that damage or ruin household property.

When the product is at work, you cannot cut off any connection lines and split the bus master and control panel. Any part of the control panel and the bus master CAN NOT be split by the user. Doing so may cause product leakage, electric shock, or other accidents.

The ground fault circuit interrupter (GFCI) should be tested regularly. It is ideal to test before each use.



Notice

Use water or mild detergent to clean the product. Do not use acids, alkalis, chemical organic solvents, or acidic/alkaline cleaning agents. Otherwise, the bathtub will experience surface damage. When water or a neutral detergent cannot remove stains, use a clean cloth with a little alcohol to remove stains.

Plating parts maintenance: use cotton fabric to scrub.

Light scratches and dulled areas may be restored to original luster by coarse grinding using NO. 1200 waterproof sandpaper dipped in water. Then fine grind by using NO. 2000 waterproof sandpaper dipped in water. Finally, polish with a soft cloth and a polishing agent.

When not in use, please keep the bathtub well-ventilated and dry; avoid contact with corrosive substances; cut off electricity and cut off water supply.

Troubleshooting Guide

PROBLEMS	CAUSES	SOLUTIONS
Pump/motor and jets do not operate	1. No power to pump/motor 2. Water level does not reach high enough 3. Defective Pump/motor	1. Check for the power connections and the fuse in blue terminal box; Make sure control panel and pumps are connected to control box properly. 2. Inflow water until it reaches the minimum water level of the bathtub 3. Contact Empava for WARRANTY & SERVICE
Not all jets are functioning	• Jets are closed	1. Adjust the jets by rotating clockwise/anticlockwise 2. Contact Empava for WARRANTY & SERVICE
Water leakage from pump/motor	1. O ring is pinched or faulty 2. Screw nut is not tightened or connected properly	1. Replace the old ring 2. Tighten the screw nut and make sure it's in good connection 3. Contact Empava for WARRANTY & SERVICE
Water leakage from PVC pipes	The glass glue is not enough	1. Apply glass glue to seal it 2. Contact Empava for WARRANTY & SERVICE
Water leakage from drainage	1. O ring is pinched or faulty 2. Drain pipe is broken	1. Replace the old ring or the drainer 2. Replace the drain pipe 3. Contact Empava for WARRANTY & SERVICE
Water leakage from hardware	1. O ring is pinched or faulty 2. Defective control valve	1. Replace the old ring or faucet/showerhead 2. Replace the control valve under knobs 3. Contact Empava for WARRANTY & SERVICE
LED lights do not operate	• Loose connection	• Contact Empava for WARRANTY & SERVICE
Waterfall is not functioning	1. Massage is not selected 2. Waterfall control knob turns to OFF position 3. Debris stuck in the waterfall outlet	1. Turn on the massage function 2. Turn waterfall knob anticlockwise to the desired water flow 3. Clean out debris

Empava® APPLIANCES

PROOF OF PURCHASE IS REQUIRED TO OBTAIN WARRANTY SERVICE.

Please have the following information available when you call/ email the Empava Customer Center:
• Proof of purchase (POF or screenshot of order confirmation)
• Model number and serial number
• A clear and comprehensive description of the issue

IF YOU NEED SERVICE: Empava Customer Center
Email: support@empava.com
Address: 458 Parriott Place West, City of Industry, California 91745, United States
Website: https://empava.com
Call: 888-682-8882 Monday - Friday from 9am - 5pm PST

Empava® APPLIANCES WARRANTY

WHAT IS COVERED

WHAT IS NOT COVERED

TWO YEARS WARRANTY (PARTS)

Empava offers a two-year warranty on parts for the following categories: induction cooktop, gas cooktop, electrical oven, pizza oven, fre glass, juicer, range hood, wine cooler, beverage refrigerator and toilet seat

TWO YEARS WARRANTY (PARTS & LABOR)

Empava offers a two-year warranty on both parts and labor for the following categories: gas oven and gas range.

THREE YEARS WARRANTY (PARTS & LABOR)

Empava provides a three-year warranty on both parts and labor for the following categories: freestanding tub, massage tub, and walk-in tub.

This limited warranty is valid for products that are either purchased brand new from an authorized Empava dealer or directly from Empava.

The effective date of the warranty commences from the date of original consumer purchase. If the appliance is installed, operated, and maintained in accordance with the user manual, Empava will provide parts at no cost to rectify any defects in materials and workmanship that were present at the time of purchase. Alternatively, at its sole discretion, Empava may replace the product. In the event of product replacement, the warranty for the replacement product shall be valid for the remaining term of the original warranty period.

DISCLAIMER OF IMPLIED WARRANTIES

IMPLIED WARRANTIES, INCLUDING ANY IMPLIED WARRANTY OF MERCHANTABILITY OR IMPLIED WARRANTY OF FITNESS FOR A PARTICULAR PURPOSE, ARE LIMITED TO ONE YEAR OR THE SHORTEST PERIOD ALLOWED BY LAW. Some states and provinces do not allow limitations on the duration of implied warranties of merchantability or fitness, so this limitation may not apply to you. This warranty gives you specific legal rights, and you also may have other rights that vary from state to state or province to province.

DISCLAIMER OF REPRESENTATIONS OUTSIDE OF WARRANTY

If you want a longer or more comprehensive warranty than the limited warranty that comes with this major appliance, you should ask Empava or your retailer about buying an extended warranty.

LIMITATION OF REMEDIES: EXCLUSION OF INCIDENTAL AND CONSEQUENTIAL DAMAGES

HEREIN, EMPAVA SHALL NOT BE LIABLE FOR INCIDENTAL OR CONSEQUENTIAL DAMAGES. Some states and provinces do not allow the exclusion or limitation of incidental or consequential damages, so these limitations and exclusions may not apply to you. This warranty gives you specific legal rights, and you also may have other rights that vary from state to state or province to province.

WARNING!
CALIFORNIA RESIDENTS
Cancer and Reproductive Harm

AVERTISSEMENT!
RÉSIDENTS DE CALIFORNIE
Cancer et Dommages à la Reproduction

¡ADVERTENCIA!
RESIDENTES DE CALIFORNIA
Cáncer y Daño Reproductivo

www.P65Warnings.ca.gov

EMPAVA APPLIANCES INC.
458 Parriott Place West, City of Industry, California
91745, United States
TEL: +1(888)682-8882
WWW.EMPAVA.COM