

Omega™ 4K/UHD HDMI over HDBaseT Receiver w/Scaler, Ethernet, RS232, Audio Output, and Input HDMI AT-OME-ST31A



The Atlona **AT-OME-ST31A** is a 3×1 switcher and HDBaseT transmitter with HDMI and USB-C inputs. Part of the Omega™ Series of integration products for modern AV communications and collaboration, it features mirrored HDMI and HDBaseT outputs, two-channel audio de-embedding to an analog balanced audio output, and is HDCP 2.2 compliant. The USB-C input is ideal for AV interfacing for newer Mac®, Chromebook™, and Windows® PCs, as well as smartphones and tablets. Video signals up to 4K/60 4:2:0 can be transmitted over HDBaseT up to 330 feet (100 meters). All inputs and the local HDMI output support 4K HDR and 4K/60 4:4:4 at HDMI data rates up to 18 Gbps. Additionally, 4K downscaling to 1080p is available for the HDMI output when connected to an HD sink. The OME-ST31A is designed for use with Omega™ Series receivers and switchers, select HDVS Series receivers, the AT-UHD-EX-100CE-RX receiver, and other Atlona switchers with HDBaseT inputs.

Package Contents

- 1 x AT-OME-ST31A
- 1 x USB-C cable
- 1 x Captive screw connector, 5-pin
- 1 x Captive screw connector, 3-pin
- 2 x Mounting brackets
- 4 x Mounting screws
- 1 x Installation Guide



IMPORTANT: Visit <http://www.atlona.com/product/AT-OME-ST31A> for the latest firmware updates and Installation Guide.



Panel Descriptions

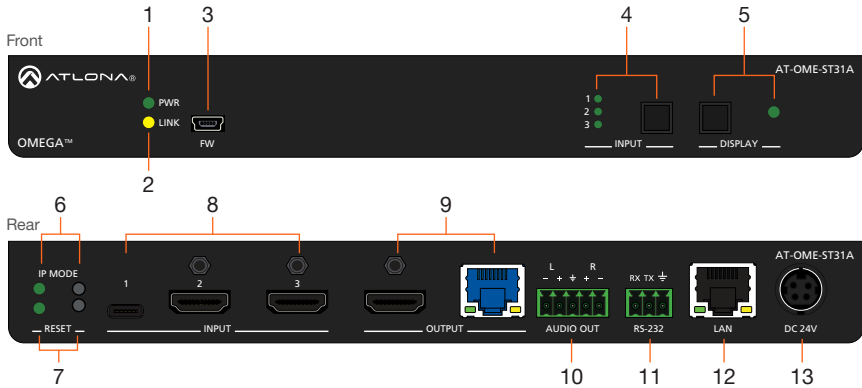

- 1 PWR**
This LED indicator glows solid green when the unit is powered.
- 2 LINK**
This LED indicator glows solid yellow when an HDBaseT link is established, between the AT-OME-ST31A and the receiver.
- 3 FW**
Connect a mini-USB cable (not included) from this port to update the firmware.
- 4 INPUT**
Press and release this button to cycle through each of the inputs. The LED indicators will display the currently active input, and correspond to each of the numbered inputs on the rear panel of the unit.
- 5 DISPLAY**
Press this button to power-on or power-off the connected display.
- 6 IP MODE**
Press and release this button to set the IP mode or display the current IP address. Refer to [IP Configuration \(page 6\)](#) for more information.
- 7 RESET**
Press and release this button to reset the unit to factory-default settings. Refer to [Resetting to Factory-Defaults \(page 6\)](#) for more information.
- 8 INPUT ports**
Connect a USB-C cable from a video source to **INPUT 1**. Connect HDMI cables from HD/UHD sources to **INPUT 2** and **INPUT 3**.
- 9 OUTPUT**
Connect an HDMI from the HDMI port to a display or other sink device. Connect a category cable (CAT-5e or better), from the HDBaseT port to a compatible HDBaseT receiver. These ports are mirrored.
- 10 AUDIO OUT**
Connect a 5-pin captive screw connector block to this port, to de-embed audio to an audio output device. Refer to [Audio Output Connector \(page 3\)](#) for more information.
- 11 RS-232**
Connect a 3-pin captive screw block to this port. Refer to [RS-232 Connector \(page 3\)](#) for wiring information.
- 12 LAN**
Connect an Ethernet cable to this port from the network.
- 13 DC 24V**
Connect the optional locking 24 V DC power supply to this power receptacle.

RS-232 Connector

The AT-OME-ST31A provides an **RS-232** port which can be used to control the unit or allow command to pass through to a downstream device. Additionally, RS-232 commands can be transmitted over HDBaseT to a PoE-compatible receiver unit.

NOTE: Typical DE-9 connectors use pin 2 for TX, pin 3 for RX, and pin 5 for ground. On some devices functions of pins 2 and 3 are reversed.

1. Use wire strippers to remove a portion of the cable jacket.
2. Remove at least 3/16" (5 mm) from the insulation of the RX, TX, and GND wires.
3. Insert the TX, RX, and GND wires into correct terminal using the included 3-pin captive screw connector.

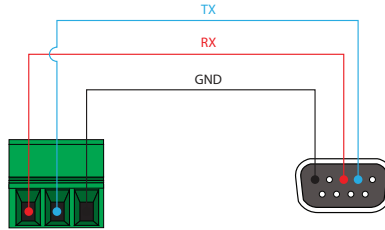
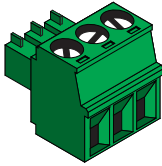

Audio Output Connector

The **AUDIO OUT** connector on the AT-OME-ST31A provides the ability to de-embed audio to an audio output device. Connect either balanced or unbalanced audio inputs, as shown below, using the included 5-pin captive screw connector block.

Balanced audio connections use two signal wires and a ground to minimize interference in audio signals. Unbalanced audio connections use one signal wire and a ground, and are used if system components don't support balanced signals.

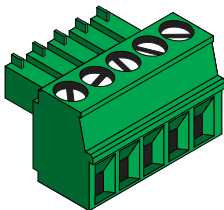

Balanced Audio using XLR Connectors

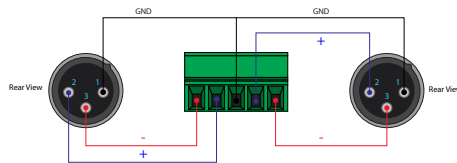

Unbalanced Audio using RCA Connectors

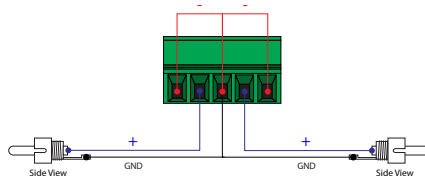

Installation

1. Connect HDMI cables from HD/UHD sources to **INPUT 2** and **INPUT 3**.
2. Connect a USB-C cable from a source to **INPUT 1** on the switcher.
3. Connect an Ethernet cable, from the **HDBaseT** port to a compatible HDBaseT receiver.



NOTE: The AT-OME-ST31A is powered over HDBaseT, by a PoE receiver unit. If a PoE HDBaseT receiver is not used, then the AT-OME-ST31A must be powered using the external 24 V DC power supply* (not included). When used with the external power supply, the AT-OME-ST31A can provide power to the connected USB-C device. This power supply can be purchased from Atlona.

4. Connect an HDMI cable from the **HDMI** output port to a display or other sink device.
5. Connect an Ethernet cable from the **LAN** port to the Local Area Network.
6. OPTIONAL: Connect an audio output device to the AUDIO OUT port, using the included captive screw connector block. Refer to [Audio Output Connector \(page 3\)](#) for wiring information.
7. OPTIONAL: Connect an RS-232 cable from the control device to the **RS-232** port on the AT-OME-ST31A. Refer to [RS-232 Connector \(page 3\)](#) for wiring information.

* Optional power supply is available from Atlona. Part no. AT-PS-245-D4.

Cable Recommendation Guidelines

Refer to the tables below for recommended cabling when using Atlona products with HDBaseT. The green bars indicate the signal quality when using each type of cable. Higher-quality signals are represented by more bars.

Core	Shielding	CAT5e	CAT6	CAT6a	CAT7
Solid	UTP (unshielded)	■	■■■	■■■■	N/A
	STP (shielded)	■■	■■■■	■■■■■	■■■■■



IMPORTANT: Stranded or patch cables are not recommended due to performance issues.

Cable*	Max. Distance @ 4K	Max. Distance @ 1080p
CAT5e	295 feet (90 meters)	330 feet (100 meters)
CAT6 / CAT6a / CAT7	330 feet (100 meters)	330 feet (100 meters)

*Atlona recommends TIA/EIA 568-B termination for optimal performance.

Mounting Instructions

The AT-OME-ST31A includes two mounting brackets, which can be used to attach the unit to any flat surface. Use the two enclosure screws, on the sides of the unit to attach the mounting brackets.

1. Using a small Phillips screwdriver, remove the two screws from the left side of the enclosure.

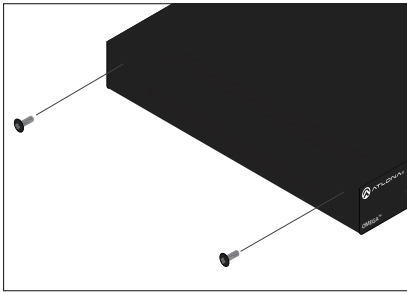

2. Position one of the mounting brackets, as shown below, aligning the holes on the side of the enclosure with one set of holes on the mounting bracket.
3. Use the screws from Step 1 to attach the mounting bracket.

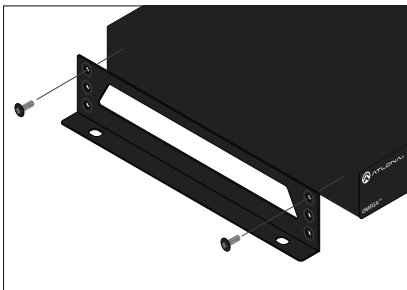

4. Repeat steps 1 and 2 to attach the second mounting bracket to the opposite side of the unit.
5. Mount the unit to a flat surface using the oval-shaped holes, on each mounting bracket. If using a drywall surface, a #6 drywall screw is recommended.

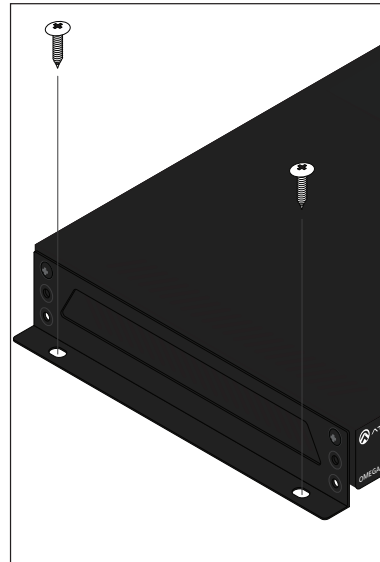

NOTE: Mounting brackets can also be inverted to mount the unit under a table or other flat surface.

IP Configuration

The AT-OME-ST31A is shipped with DHCP enabled. Once connected to a network, the DHCP server (if available), will automatically assign an IP address to the unit. If the AT-OME-ST31A is unable to detect a DHCP server within 15 seconds, then the unit will use a self-assigned IP address within the range of **169.254.xxx.xxx**.

Use an IP scanner, along with the MAC address on the bottom of the unit, to identify the unit on the network. If a static IP address is desired, the unit can be switched to static IP mode. The default static IP address is **192.168.1.254**.

Switching the IP mode

1. Make sure the AT-OME-ST31A is powered, by connecting a category cable (CAT-5e or better) between a PoE-compatible receiver, such as the AT-HDVS-200-RX or AT-HDVS-SC-RX, and the **HDBaseT** port on the back of the unit.
2. Press and hold the **IP MODE** button, on the rear of the unit, for approximately five seconds. Release the button once the LED indicator, next to the **IP MODE** button, begins to flash green. The number of flashes will indicate the currently selected IP mode.

IP MODE LED flashes	Description
Four	DHCP mode
Two	Factory Static IP mode (IP address set to 192.168.1.254)

Auto IP mode

If the AT-OME-ST31A is unable to detect a DHCP server within 15 seconds, then the unit will use a self-assigned IP address within the range of **169.254.xxx.xxx**. If this occurs, connect the AT-OME-ST31A to a computer running Microsoft Windows® and follow the procedure below.

1. Click **Start > Settings > Control Panel > Network and Sharing Center**.
2. Click **Change adapter settings**.
3. Right-click on the adapter that is used to establish a wired connection to the network, and select **Properties** from the context menu.
4. Under the **Ethernet Properties** dialog box, select **Internet Protocol Version 4** and then click the **Properties** button.
5. Click the **Use the following IP address** radio button.



IMPORTANT: Before continuing, write down the current IP settings in order to restore them, later. If **Obtain an IP address automatically** and **Obtain DNS server automatically** are selected, then this step is not required.

6. Enter the desired static IP address or the IP address provided by the network administrator. If the PC does not require Internet access or if a statically-assigned IP address is being used, then an IP address of **169.254.xxx.xxx** can be entered.
7. Set the subnet mask to **255.255.0.0**.
8. Click the **OK** button then close all **Control Panel** windows.



Displaying the IP Address

To display the IP address of the AT-OME-ST31A on the connected display, press and release the **IP MODE** button.

Resetting to Factory-Defaults

To reset the AT-OME-ST31A to factory-default settings, press and hold the **RESET** button for approximately 5 seconds. Release the button once the **RESET** LED indicator begins to flash. The LED indicator will flash three times to indicate that the reset procedure has completed.

AMS 2.0

For easy configuration of Atlona devices, AMS 2.0 is available from <https://atlona.com/ams> for free. Two options can be used for installation: The free Linux-based software download or the easy-to-install server hardware (AT-AMS-HW).

Once AMS has been set up:

1. Open a browser on the same network as AMS 2.0 and go to the IP address of AMS 2.0. View the AMS 2.0 installation instructions on how to find the IP address of the software, if necessary.
2. Enter the login information on the AMS 2.0 web page, then click the **Login** button.
3. View the AT-OME-ST31A manual for more information.



Web GUI



The AT-OME-ST31A includes a built-in web GUI, which allows easy management and control of all features. Follow the instructions below to access the web GUI.



1. Set the IP mode of the AT-OME-ST31A. Refer to [IP Configuration \(page 6\)](#) for more information.
2. Connect an Ethernet cable from the **LAN** port on the AT-OME-ST31A to the Local Area Network (LAN).
3. Use an IP scanner to determine the IP address of the AT-OME-ST31A.
4. Launch a web browser and enter the IP address of the unit.
5. The AT-OME-ST31A **Login** page will be displayed.
6. Enter the following information on the **Login** page. Login credentials are case-sensitive.
Login: **admin**
Password: **Atlona**
7. Click the **Login** button.

Front Panel LED Indicators

The LED indicators on both the front and rear of the unit provide basic information on the current status of the unit.

PWR		Description
Solid green		Unit is receiving power using the optional 24 V DC power supply (not included) or the category cable connected between the HDBaseT OUTPUT port and a PoE-compatible receiver.
Off		Unit is not powered.

LINK		Description
Solid yellow		An HDBaseT link is established between the transmitter and the receiver.
Off		The link integrity between the AT-OME-ST31A and the PoE-compatible receiver is compromised.

1, 2, 3		Description
Solid green		The input is the currently selected input.
Off		The input is not selected.

toggling Display Power

Press and release the **DISPLAY** button to toggle power of the connected display. Configuration is performed using the built-in web GUI.



Notes



Notes



Notes



Toll free US International
atlona.com • 877.536.3976 • 41.43.508.4321