



COSTWAY

WHERE THERE IS COSTWAY THERE IS HOME



USER'S MANUAL

Stand Mixer

EP24048

Technical Data

Model: EP24048

Rated voltage: 120V~60Hz

Power consumption: 660W

IMPORTANT SAFEGUARDS

Read the operating instructions carefully before putting the appliance into operation and keep the instructions including the warranty, the receipt and, if possible, the box with the internal packing. If you give this device to other people, please also pass on the operating instructions.

- Read all instructions.
- To protect against risk of electrical shock do not put base in water or other liquid.
- Close supervision is necessary when any appliance is used by or near children.
- Unplug from outlet when not in use, before putting on or taking off parts, and before cleaning.
- Avoid contacting moving parts.
- Do not operate any appliance with a damaged cord or plug or after the appliance malfunctions, or is dropped or damaged in any manner. Return appliance to the nearest authorized service facility for examination, repair or electrical or mechanical adjustment.
- The use of attachments not recommended or sold by the manufacturer may cause fire, electric shock or injury.
- Do not use outdoors.
- Do not let cord hang over edge of table or counter.
- Keep hands, hair, clothing, as well as spatulas and other utensils away from beaters during operation to reduce the risk of injury to persons, or damage to the mixer.
- Remove beaters from mixer before washing.
- Household use only.

SAVE THESE INSTRUCTIONS

This appliance has a polarized plug (one blade is wider than the other). To reduce the risk of electric shock, this plug will fit in a polarized outlet only one way. If the plug does not fit fully in the outlet, reverse the plug. If it still does not fit, contact a qualified electrician. Do not modify the plug in any way.

Children and Frail Individuals

- In order to ensure your children's safety, please keep all packaging (plastic bags, boxes, polystyrene etc.) out of their reach.

Caution! Do not allow small children to play with the foil as there is a **danger of suffocation!**

- In order to protect children or frail individuals from the hazards of electrical equipment, please ensure that this device is only used under supervision. This device is not a toy. Do not allow small children to play with it.

Special safety Instructions for this Machine

- Only operate this machine under supervision.
- Do not interfere with any safety switches.
- Do not insert anything into the rotating hooks while the machine is working.
- Place the machine on a smooth, flat and stable working surface.
- Do not insert the mains plug of the machine into the power socket without having installed all the necessary accessories.

Overload Protection System

The motor is protected from burning out by a Thermal Protector. If the appliance is overloaded or operated continuously for too long, the motor may overheat and stop. To operate the appliance again, it must be switched off and disconnected from the power socket then left for at least 30 minutes. Once the motor is fully cooled the appliance may be used again.

Safety Instructions

The motor will not start if the Mixer Head is raised. If it is raised during normal operation, the safety switch will activate and the motor will shut off immediately.

Additionally, if the appliance is plugged in while the speed control is not set at 0, the safety system will prevent it from running.

In either case, to start the machine again, return the head to the locked position and turn the Speed Control back to 0. The appliance should now function as normal.

Overview of the Components

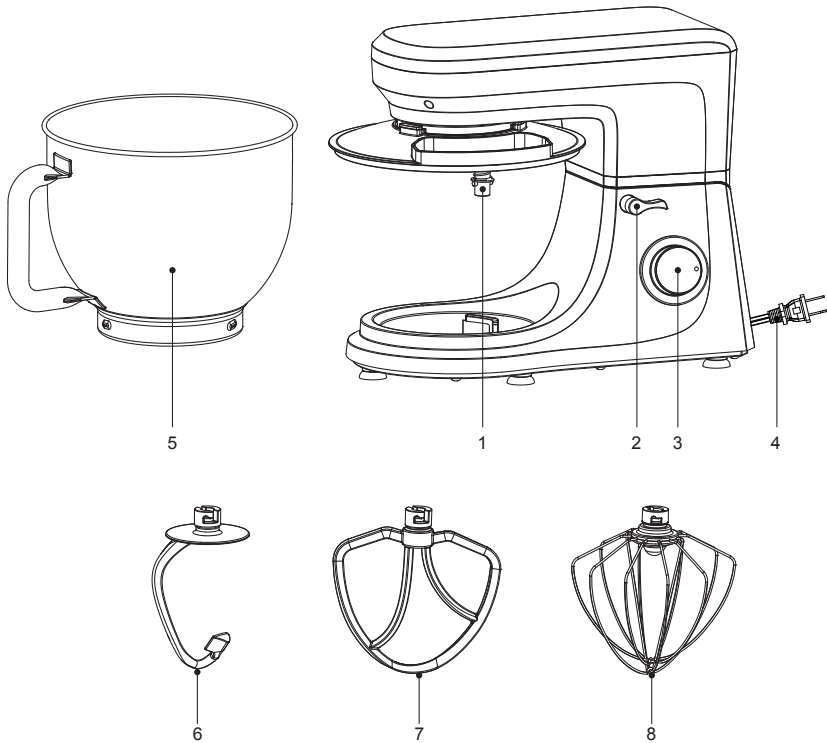

Main Components and Standard Accessories:

1	Output shaft	6	Dough hook
2	Tilt-up knob	7	Beater
3	Speed control dial	8	Whisk
4	Power cord	9	Bowl cover
5	Mixing bowl		

Before using Stand Mixer

1. Before assembling the appliance, remove and safely discard any packaging material.
2. Wash the mixing bowl, Beater, Dough Hook and Whisk attachments in warm soapy water with a soft cloth then rinse and dry.

Using the Mixing Bowl

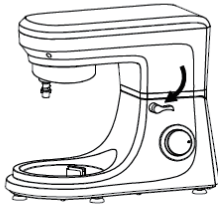

FIG1

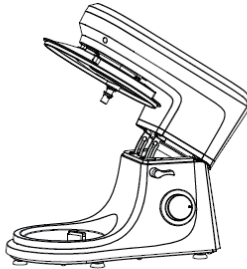

FIG2

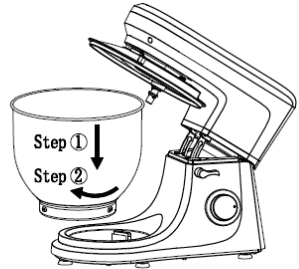

FIG3

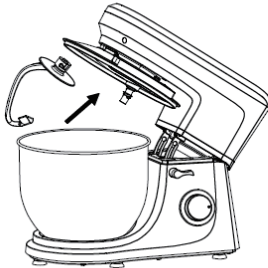

FIG4



FIG5

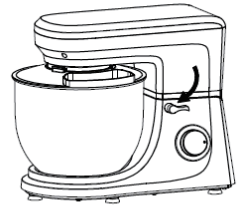

FIG6



1. Set the Speed Control Dial to the "OFF" position.

Note: If the Speed Control is not at 0, the machine's safety feature will be triggered and it will not activate when switched on. If this happens, see Safety Instructions for how to get the appliance running.

2. Place one hand on top of the Mixer Head and with other hand downward rotating the Tilt Button as per the arrow showed to lift the Mixer Head up until it stops. Release the "Tilt" button. The Mixer Head will lock into the elevated position.
3. Attach the Splash Guard to the Upper Body directly.
4. Fit the bowl so that it aligns with the grooves on the Mixer Stand. To lock the mixing bowl, turn it clockwise following "LOCK" on the Mixer Stand. Make sure that the mixing bowl is securely locked in place.
5. Insert the accessory Dough Hook, Beater or Whisk according to the recipe requirements. Align the chosen attachment so that grooves on attachment align with the Attachment Shaft located under the Mixer Head. With some pressure, push the attachment towards the Mixer Head, lifting the Attachment Shaft spring upwards and twist the attachment in an anti-clockwise direction. Make sure that the attachment is securely locked in place.
6. Add ingredients into the Mixing Bowl supplied as listed in the recipe. Do not overfill the bowl. It is recommended not to mix more than 2.0 kg mixture each time. For kneading dough, the proportion of flour and water is near 2:1 such as 1000g dough+530g water.

7. Place one hand on top of the Mixer Head and with other hand downward rotating the Tilt Button as per the arrow showed. Push the Mixer Head down so that it is in the horizontal position and the Dough Hook, Beater or Whisk attachment is inside the Mixing Bowl. Release the "Tilt" button.
8. Plug the power cord into the mains supply. This will make the Speed Control light up and flash blue.
9. Turn the Speed Control clockwise to select a speed and start mixing. The Speed Control Dial will illuminate blue. It's recommended that mixing is started at a lower speed to prevent splattering and then increased to suit the recipe. Consult the Mixing Guide for example speeds.
10. Use the **Pulse** Function when you require a quick burst of power or for quick incorporations. Turn the Speed Control Dial in an anti-clockwise direction and hold it in this position. When the dial is released, it returns to the "OFF" position automatically.
11. When mixing is complete, turn the Speed Control Dial to the "OFF" position, switch the appliance off at the power outlet and remove the power cord from the outlet.
12. Remove the Dough Hook, Beater or Whisk -- Lifting up the Mixer Head, then hold onto the assembled attachment. With some pressure, push the attachment towards the Mixer Head, lifting the Attachment Shaft spring upwards and twist the attachment in a clockwise direction. Pull the attachment away from the Attachment Shaft to remove it from the Mixer Head.
13. Clean the parts as described under "Cleaning".

Mixing Guide

Use	Picture	Levels	Time(Min)	Recommended Maximum Recipe	Remarks
Dough hook		1-3	3	1000g flour and 530g water	Heavy mixtures(e.g. bread or short pastry)
Beater		2-4	3	660g flour and 840g water	Medium-heavy mixtures(e.g. crepes or sponge mixture)
Whisk		5-6	3	3 egg whites (Minimum)	Light mixtures (e.g. cream, egg white, blancmange)

Troubleshooting

NO.	Troubles	Solutions
1	The machine doesn't work	<ul style="list-style-type: none"> · Check if the plug is plugged into the socket well. · Check if the Tilt-up Knob is back in place. · Check if the machine works continuously more than 6 minutes, and wait until the motor cool down.
2	Noise in the mixing bowl when working (the accessory scraped the bowl)	<ul style="list-style-type: none"> · Check if the mixing bowl is properly installed. · Check if the accessory is installed properly to the machine.
3	The Bowl cover doesn't fit the mixing bowl properly	<ul style="list-style-type: none"> · Check if the pot cover is placed to the machine properly. · Check if the mixing bowl is installed properly to machine and locked correctly.
4	The machine doesn't work on certain speed	<ul style="list-style-type: none"> · Check if the mark on speed knob corresponds to the speed silkscreen on housing. · Rotate speed knob to 0 ,and re-check if the machine works .
5	Movements when the machine working	<ul style="list-style-type: none"> · Check if the anti-slip feet fall off. · Check if the machine is placed on a smooth and flat tabletop.
6	The Tilt-up knob didn't spring back in place after installing the mixing bowl and Bowl cover	<ul style="list-style-type: none"> · Check if the bowl cover is placed on the machine properly. · Check if the mixing bowl is properly installed.

Cleaning

- Before cleaning, make sure the appliance has been unplugged from the power supply.
- Never immerse the appliance into any liquid.
- Hand wash the Dough Hook, Beater, Whisk and mixing bowl in warm soapy water with a soft cloth after each use. Rinse and dry thoroughly. The Die-casting Aluminium Dough Hook and Beater are not dishwasher safe.
- Clean the housing of the appliance with a damp cloth only.
- Do not expose them to heat or caustic cleaner. If so, they might become misshapen or discolored.
- Do not use any sharp or abrasive detergents.

Disposal



Do not dispose of the device in normal domestic waste.

Dispose of the device over a registered waste disposal firm or through your communal waste disposal facility. Observe the currently valid regulations. In case of doubt, consult your waste disposal facility.



TIPS:

Your suggestions and comments for Costway are really important to us!
We sincerely solicit you to go back to our shop and leave a good rating in just a simple click. It would be quite encouraging if you could kindly do so like below:

★★★★★ Great products so far

February 24, 2018

Great product so far. Fast delivery, easy setup, and working without any issues.

With your inspiring rating, Costway will be more consistent to offer you
EASY SHOPPING EXPERIENCE, GOOD PRODUCTS and EFFICIENT SERVICE!



COSTWAY

WHERE THERE IS COSTWAY THERE IS HOME

