

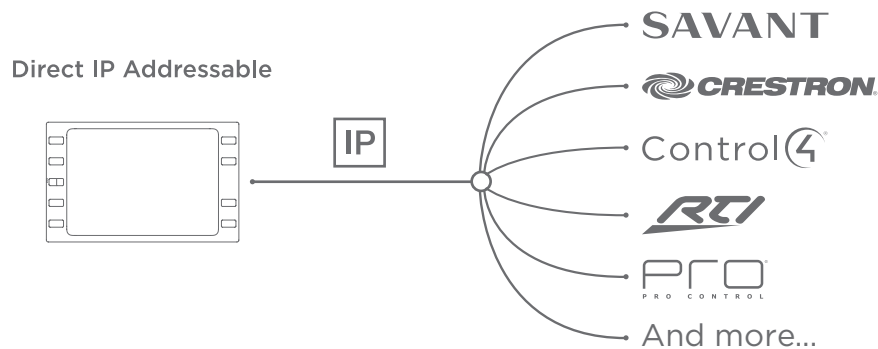

Surface Mount with Buttons

iPad® mount and IP keypad combined in one elegant device.

Surface Mount with Buttons offers the best of both worlds: the immediate access of key functions via buttons combined with the richness of Apps on an iPad. Connect with nearly control system directly via IP.



SYSTEMS



For iPad Pro 12.9"

- Precision machined aluminum bezel
- Easily mounts on any surface
- Security lock
- Includes PoE Splitter

10 Buttons - \$849

SKU - #70781 (black)
 SKU - #70782 (silver)
 SKU - #70783 (white)

6 Buttons - \$799

SKU - #70778 (black)
 SKU - #70779 (silver)
 SKU - #70780 (white)



For iPad Air 1, 2, Pro 9.7"

- Precision machined aluminum bezel
- Easily mounts on any surface
- Security lock
- Includes PoE Splitter

10 Buttons - \$699

SKU - #70761 (black)
 SKU - #70762 (silver)
 SKU - #70763 (white)

6 Buttons - \$649

SKU - #70767 (black)
 SKU - #70768 (silver)
 SKU - #70769 (white)



For iPad mini 4

- Precision machined aluminum bezel
- Easily mounts on any surface
- Security lock
- Includes PoE Splitter

10 Buttons - \$649

SKU - #70758 (black)
 SKU - #70759 (silver)
 SKU - #70760 (white)

6 Buttons - \$599

SKU - #70764 (black)
 SKU - #70765 (silver)
 SKU - #70766 (white)

BUTTONS

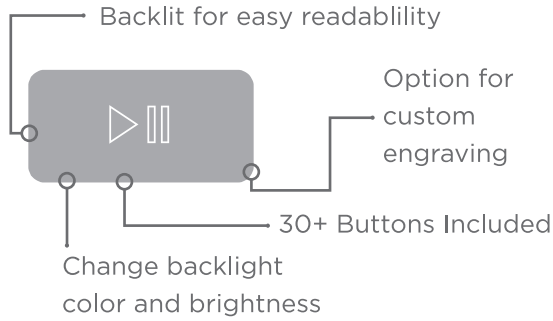

Included Buttons

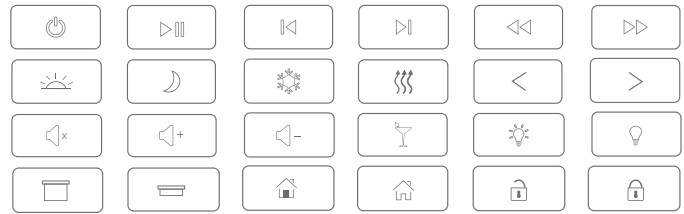

FEATURES



POWER & DATA OPTIONS

The Surface Mount System with Buttons enables you to power iPad and provide power and data to buttons from a single CAT-5 cable and PoE switch. With the optional Poe Injector, you can use non-PoE switches and routers to provide data to button while the injector sends power to iPad and buttons.

Power Options	PoE Splitter (Included)	PoE Injector (Sold Separately)
PoE Switch	●	
Receptacle	●	●

Power iPad via PoE (Power over Ethernet).

PoE Switch

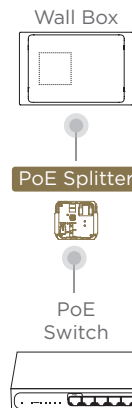

Non PoE Switch

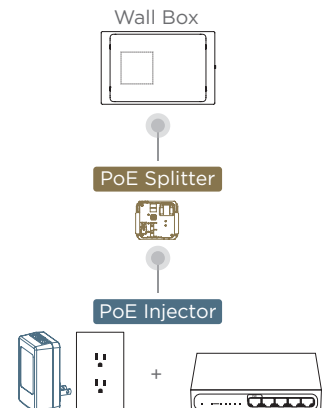

SURFACE MOUNT SPECIFICATIONS

Buttons System Pro 12.9"

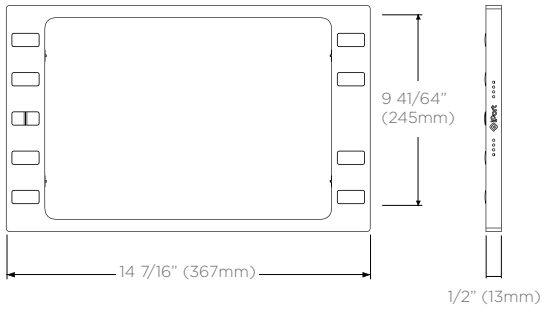

Dimensions

Weight:
 10 Buttons- 2.41 lbs
 (Bezel & mounting plate)
 6 Buttons- 2.38 lbs
 (Bezel & mounting plate)
 Height: 9 41/64"
 Width: 14 7/16"
 Depth: 1/2"

Compatibility

- Works with iPad Pro 12.9"

What's in the Box

- Bezel & mounting hardware
- Security Tool
- Quickstart Guide
- PoE Splitter

10 Buttons

\$849
SKU (Black)
 #70781
SKU (Silver)
 #70782
SKU (White)
 #70783

6 Buttons

\$799
SKU (Black)
 #70778
SKU (Silver)
 #70779
SKU (White)
 #70780

Buttons System Air 1, 2, Pro 9.7"

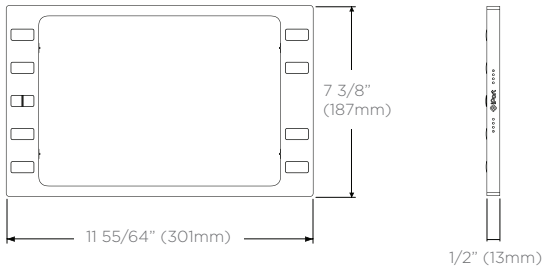

Dimensions

Weight:
 10 Buttons- 1.31 lbs
 (Bezel & mounting plate)
 6 Buttons- 1.28 lbs
 (Bezel & mounting plate)
 Height: 7 3/8"
 Width: 11 55/64"
 Depth: 1/2"

Compatibility

- Works with iPad Air 1, 2, Pro 9.7"

What's in the Box

- Bezel & mounting hardware
- Security Tool
- Quickstart Guide
- PoE Splitter

10 Buttons

\$699
SKU (Black)
 #70761
SKU (Silver)
 #70762
SKU (White)
 #70763

6 Buttons

\$649
SKU (Black)
 #70767
SKU (Silver)
 #70768
SKU (White)
 #70769

*Top Speakers and camera flash may be covered.

Buttons System mini 4

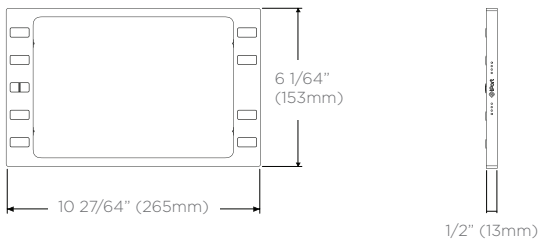

Dimensions

Weight:
 10 Buttons- 1.07 lbs
 (Bezel & mounting plate)
 6 Buttons- 1.04 lbs
 (Bezel & mounting plate)
 Height: 6 1/64"
 Width: 10 27/64"
 Depth: 1/2"

Compatibility

- Works with iPad mini 4

What's in the Box

- Bezel & mounting hardware
- Security Tool
- Quickstart Guide
- PoE Splitter

10 Buttons

\$649
SKU (Black)
 #70758
SKU (Silver)
 #70759
SKU (White)
 #70760

6 Buttons

\$599
SKU (Black)
 #70764
SKU (Silver)
 #70765
SKU (White)
 #70766

PoE Splitter (Included in System)

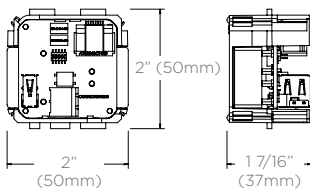

Dimensions

Weight: 0.14 lbs
 Height: 2"
 Width: 2"
 Depth: 1 7/16"

Power

- Input: IEEE 802.3af
- Output: USB 5V up to 12W
- AUX Input: 18V to 24V

MSRP - \$120

SKU - #70718

PoE Injector (Sold Separately)

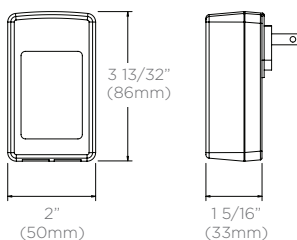

Dimensions

Weight: (Injector only)
 0.21 lbs
 Height: 3 13/32"
 Width: 2"
 Depth: 1 5/16"

Power

- Input: AC110-240V ~50/60Hz 0.5A
- Output: PoE IEEE 802.3af

MSRP - \$50

SKU - #70719



Learn more at iportproducts.com/surfacemountbuttons