

**BBD3022 110V**  
**14-LIGHT CHANDELIER**

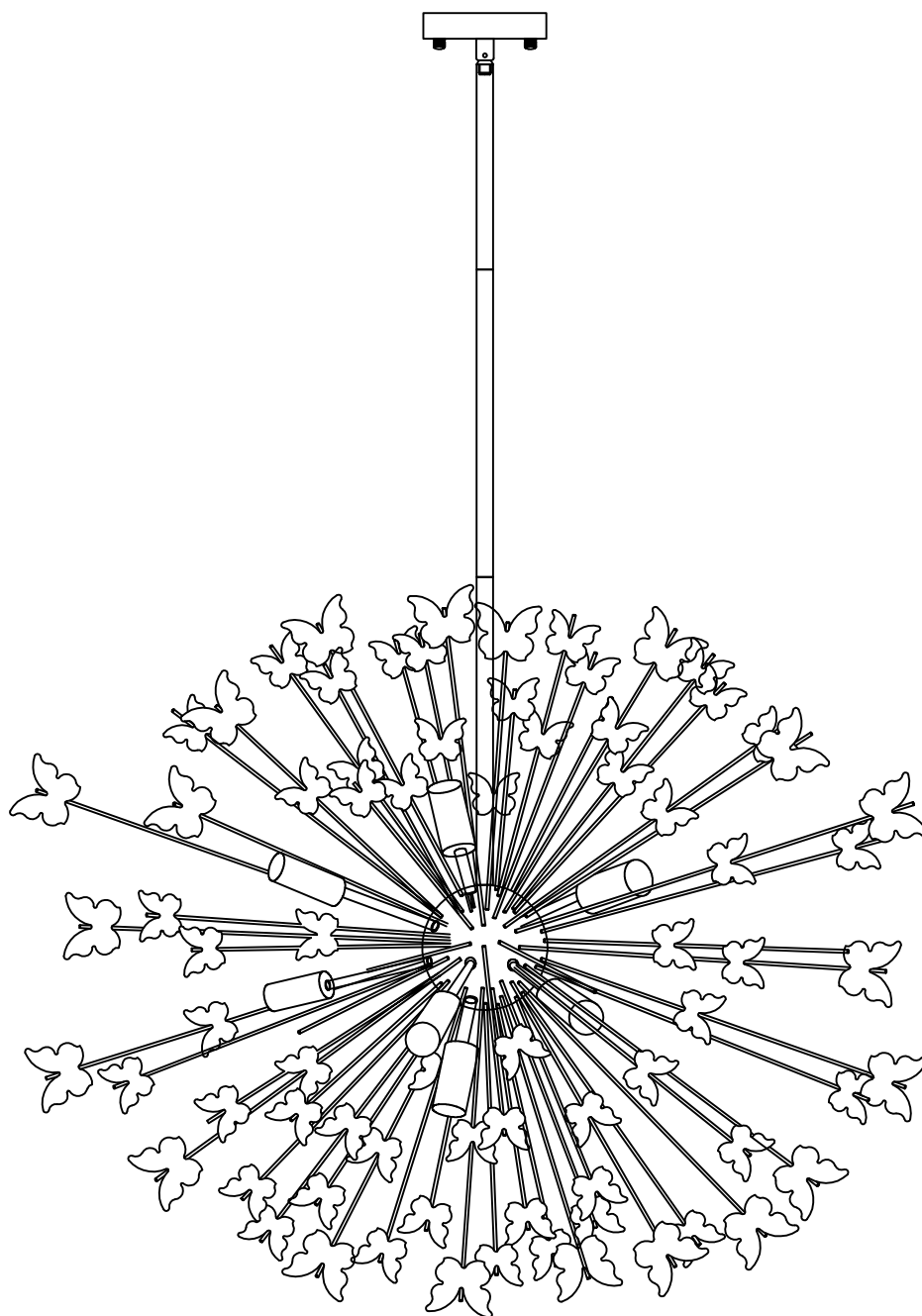

### PACKAGE CONTENTS

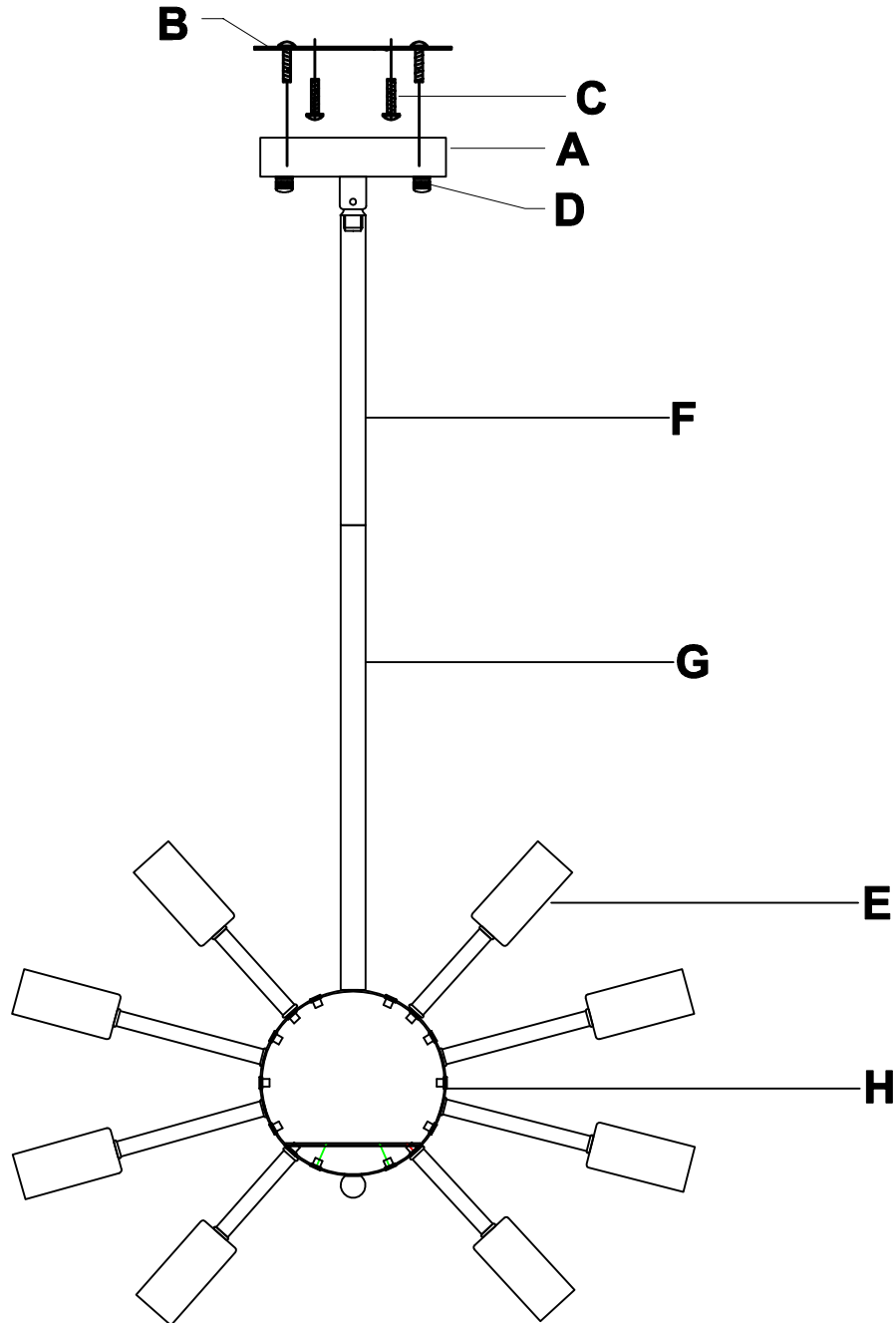

PART	DESCRIPTION	QTY.	PART	DESCRIPTION	QTY.
A	Canopy	1	G	300 long suspension rod	2
B	Mounting Bracket	1	H	Lamp body	1
C	Tapping screw	2			
D	Flower branch mother	2			
E	Socket	14			
F	200 long suspension rod	2			

### HARDWARE CONTENTS

---

**AA**



Wire

Connector  
Qty: 3

**BB**

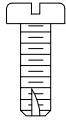

Short  
Machine  
Screw  
Qty: 2

### ! SAFETY INFORMATION

---

Please read and understand this entire manual before attempting to assemble, operate or install the product.

### ! WARNING

- . IMPORTANT: NEVER attempt any work without shutting off the electricity.
- . Place the main power switch in the "OFF" position and unscrew the fuse(s), or switch "OFF" the circuit breaker switch(es), that control the power to the fixture or room you are working in.
- . Place the wall switch in the "OFF" position. If the fixture to be replaced has a switch or pull chain, place it in the "OFF" position.

### CAUTION

- . If you have any doubts about how to install this lighting fixture, or if the fixture fails to operate completely, please contact a licensed electrical contractor.
- . All parts must be used as indicated in these instructions. Do not substitute any parts, leave parts out, or use any parts that are worn out or broken. Failure to obey this instruction could invalidate ETL listing and/or C.S.A. certification of this fixture.

### PREPARATION

---

Before beginning assembly of product, make sure all parts are present. Compare parts with package contents list and hardware contents list. If any part is missing or damaged, do not attempt to assemble the product.

**Estimated assembly time: 30 minutes to 1 hour**

Tools Required for Assembly (not included): Phillips screwdriver, flathead screwdriver, wire strippers, electrical tape, ladder, safety glasses.

### ASSEMBLY INSTRUCTIONS

1. Lamp body (H) 200 long suspension rod (F)  
300 long suspension rod (G)

**Note:** Thread the main line of the lamp body through the suspension rod in sequence, and then tighten the suspension rod onto the lamp body in sequence.

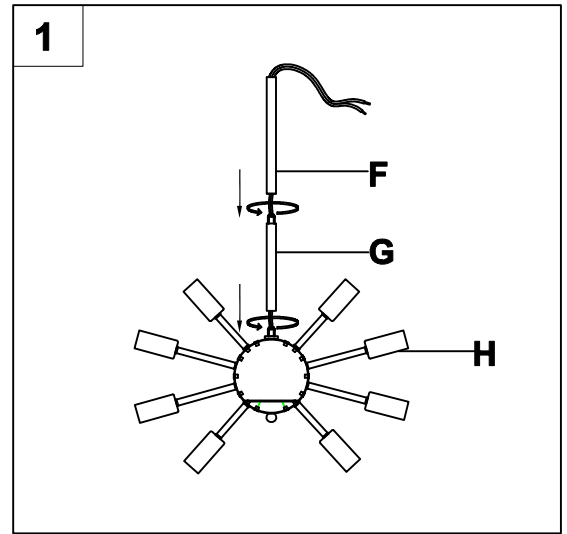

2. Canopy (A).

**Note:** Tighten the ceiling disc onto the suspension rod.

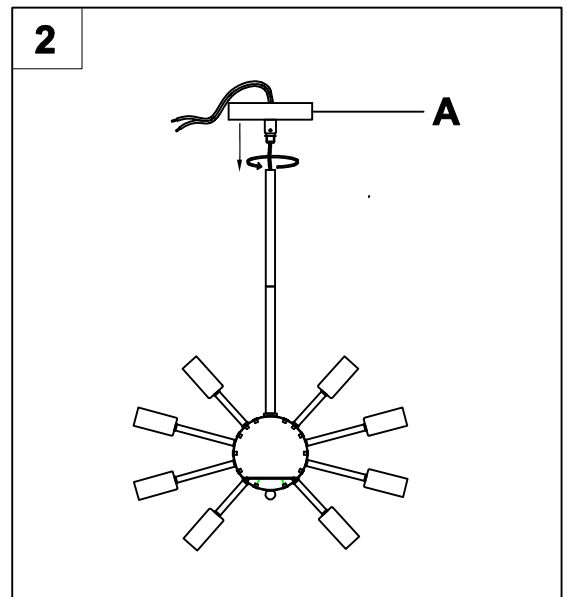

3. Mounting Bracket (B) Tapping screw (C)

**Note:** Tighten the hanging plate onto the wall with self tapping screws

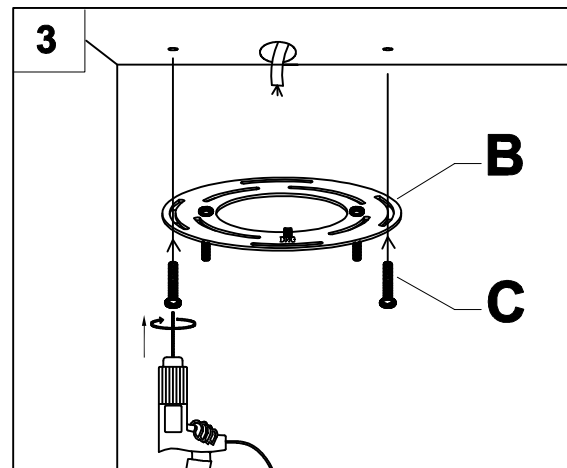

### ASSEMBLY INSTRUCTIONS

#### 4. Wire connection guide:

##### Ground wire:

- For installation in the United States: Wrap ground wire from outlet box around ground screw preassembled on mounting bracket (B) no less than 2 in. from wire end. Tighten ground screw. If fixture is supplied with a ground wire, connect to outlet ground wire with a wire connector (AA).
- For installation in Canada: If fixture is supplied with ground wire, wrap ground wire around ground screw on mounting bracket (B). Tighten ground screw. Connect fixture ground wire to outlet ground wire with the wire connector (AA).

##### Supply wires:

- Connect the Neutral (White) supply wire from the outlet box to the Neutral fixture wire (White or Parallel Cord "D" shaped and ribbed).
- Connect the Hot (Black) supply wire from the outlet box to the Hot fixture wire (Black or Parallel Cord round and smooth).

##### NOTE:

Fixture wires will either be:

- Black and White.
- Parallel Cord SPT-1 lamp wire with one round smooth wire and one "D" shaped ribbed wire.

#### Hardware Used

AA Wire Connector



x 3

#### 5. Mounting Bracket (B) Canopy (A)

Flower branch mother (D)

**Note:** Align the hole position of the ceiling panel with the hanging plate screw, and top the lamp body onto the wall. Lock the lamp body with flower branch nuts.

<p><b>4</b></p> <p>BARE COPPER, OR GREEN GROUND SUPPLY WIRE</p> <p>BLACK SUPPLY WIRE</p> <p>WHITE SUPPLY WIRE</p> <p>BLACK SUPPLY WIRE</p> <p>WHITE SUPPLY WIRE</p>	<p><b>AA</b></p> <p>BARE COPPER, OR GREEN GROUND FIXTURE WIRE</p> <p>BLACK FIXTURE WIRE</p> <p>WHITE FIXTURE WIRE</p> <p>OR PARALLEL FIXTURE CORD (ROUND AND SMOOTH)</p> <p>PARALLEL FIXTURE CORD ("D" SHAPED AND RIDGED)</p>
---	---

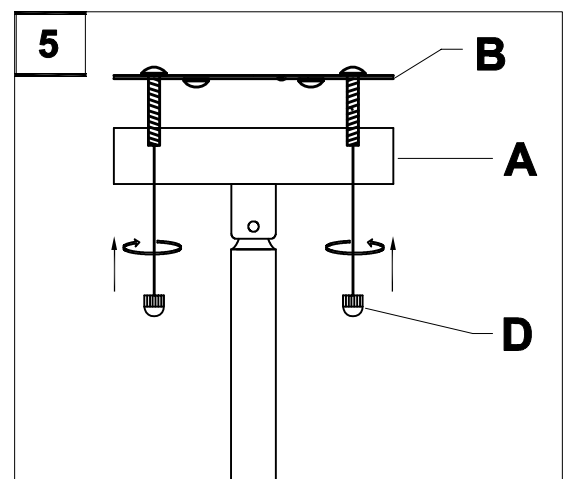
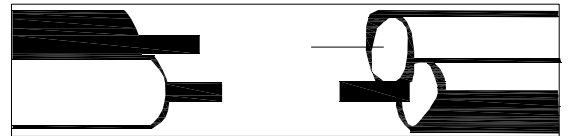

### ASSEMBLY INSTRUCTIONS

6. Insert 40-watt max. candelabra-base incandescent bulb or CFL/LED equivalent (none included) into socket (E).

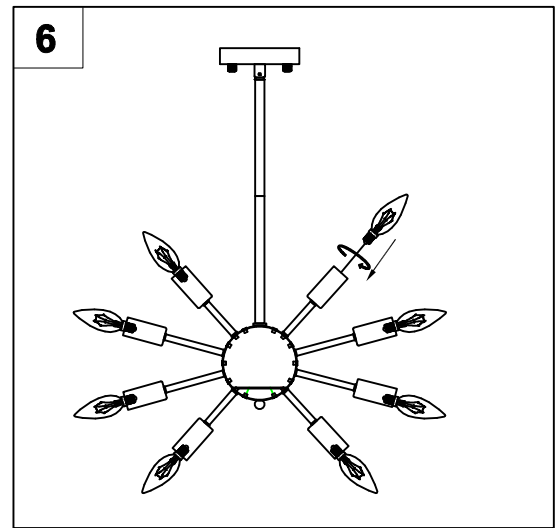

7.

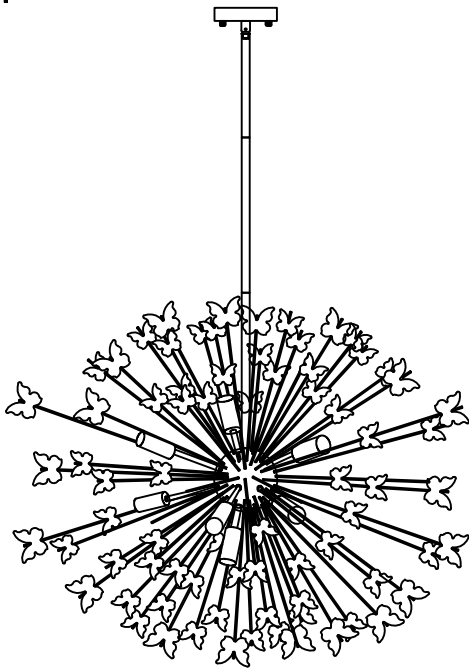

Please tighten the butterfly stem onto the lamp body in sequence according to its length.

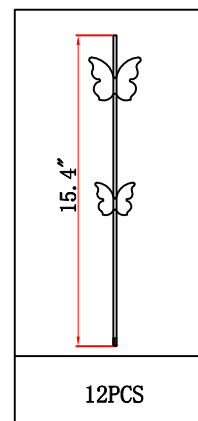
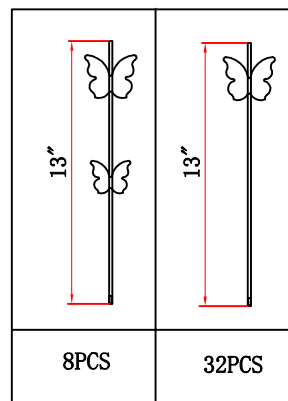
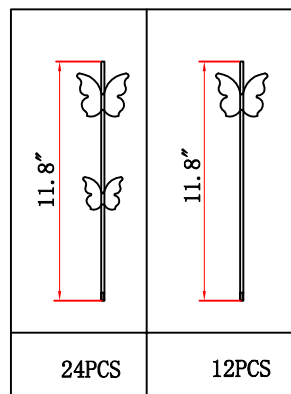
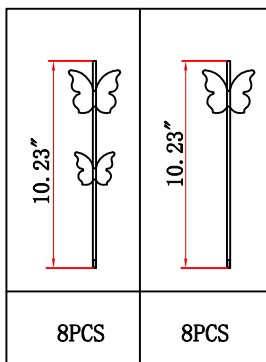

### ASSEMBLY INSTRUCTIONS

The top first layer and the bottom first layer.

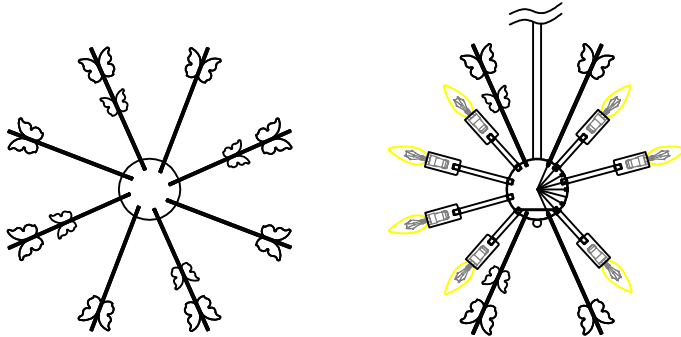

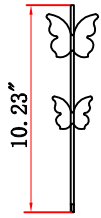
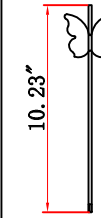
	
8PCS	8PCS

Attention: The two styles of butterfly suspension rods should be staggered and tightened on the lamp body ball.

The top second layer and the bottom second layer.

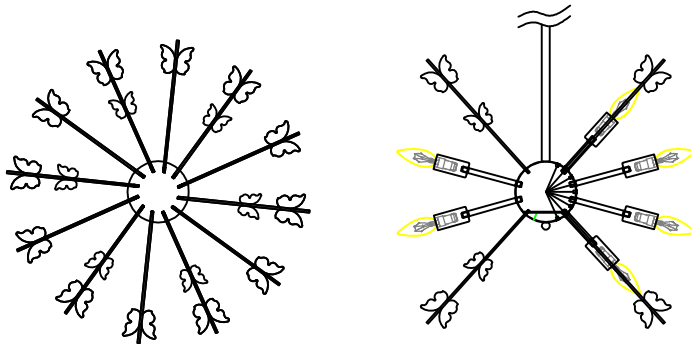

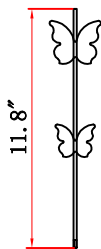
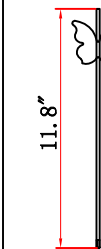
	
12PCS	12PCS

Attention: The two styles of butterfly suspension rods should be staggered and tightened on the lamp body ball.

The top third layer and the bottom third layer.

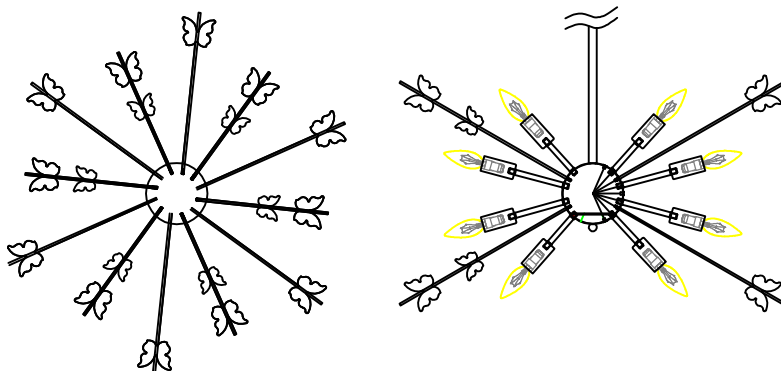

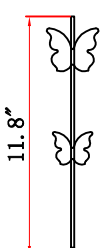
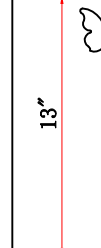
	
12PCS	12PCS

Attention: The two styles of butterfly suspension rods should be staggered and tightened on the lamp body ball.

### ASSEMBLY INSTRUCTIONS

The fourth layer at the top and the fourth layer at the bottom.

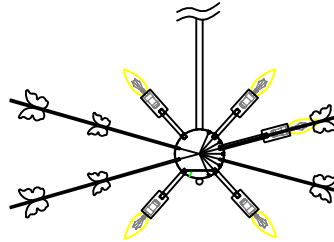
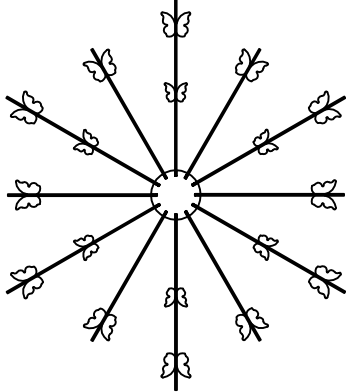

13"	15.4"
12PCS	12PCS

Attention: The two styles of butterfly suspension rods should be staggered and tightened on the lamp body ball.

The fifth layer in the middle

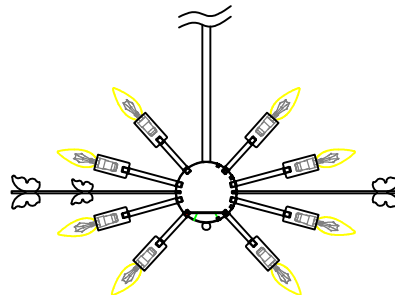
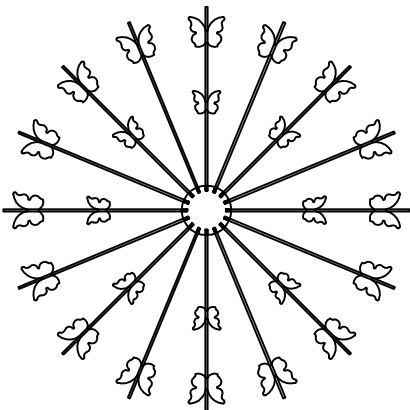

13"	13"
8PCS	8PCS

Attention: The two styles of butterfly suspension rods should be staggered and tightened on the lamp body ball.

### CARE AND MAINTENANCE

- . Always be certain that electric current is turned off before cleaning this item.
- . Use a soft, moist cloth with mild non-abrasive soap to clean fixture. Never use glass cleaner on fixture, as it will damage the metal finish.
- . All glass shades may be washed in a towel-lined sink with warm water and mild soap. Do not wash shades in an automatic dishwasher.

### TROUBLESHOOTING

PROBLEM	POSSIBLE CAUSE	CORRECTIVE ACTION
Fixture does not light.	1. Fixture may be wired incorrectly. 2. Worn or broken bulb.	1. Check wiring. 2. Replace bulb.



**BBD3022 110V**

Installation & Operating Instructions for the  
Parrotuncle Owner's Installation ,Manual

**WARNING: SHUT POWER OFF AT FUSE OR CIRCUIT BREAKER**

## **WARRANTY**

Parrot Uncle warrants that its products will be free from defects in material and workmanship for one (1) year from the date of purchase by the Original Purchaser.

To replace a product that has a warranted defect, the Original Purchaser shall return any allegedly defective parts or products to the authorized Parrot Uncle warehouse that the product was purchased from with **PROOF OF PURCHASE**, Original Purchaser's name and return address and a description of the claimed product defect.

If any of the warranted products are found by Parrot Uncle, in its sole discretion, to be defective, such products will, at Parrot Uncle's sole option and cost, be replaced, repaired or refunded less an amount directly attributable to Original Purchaser's prior use of the product. Parrot Uncle will return the repaired or replaced product prepaid freight. This warranty does not cover labor or other costs or expenses to remove or install any defective, repaired or replaced product.

The parties here to expressly agree that Original Purchaser's sole and exclusive remedy against Parrot Uncle shall be for the repair, replacement or refund of defective products as provided here in. This warranty extends only to product ownership by the Original Purchaser; is not transferable whether to heirs, subsequent owners, or otherwise; and is void if the Original Purchaser ceases to own the product.

This warranty does not apply to any products that have been subjected to misuse, mishandling, misapplication, connected to voltage at more than 5% above standard North American voltage, unusual use (including but not limited to use in an environment where the annual average ambient operating temperature is below 27 or above 95 degrees Fahrenheit), neglect (including but not limited to improper maintenance), accident, acts of god such as high winds, improper installation or care, failure to follow the Product's written instructions for normal use and care, improper packaging of products returned to Parrot Uncle, modification (including but not limited to use of unauthorized parts or attachments), or adjustment or repair. Significant product exposure to chemicals, harsh cleaners, salt water or salt air will void any and all warranties on exterior finishes. This warranty only applies when all components, including transformers, have been provided by Parrot Uncle. Substituting another manufacturer's product and/or components will render the warranty completely void.

**THIS WARRANTY GIVES YOU SPECIFIC LEGAL RIGHTS. YOU MAY ALSO HAVE OTHER RIGHTS, WHICH VARY FROM STATE TO STATE. SOME STATES DO NOT ALLOW LIMITATIONS ON HOW LONG AN IMPLIED WARRANTY LASTS OR THE EXCLUSION OR LIMITATION OF INCIDENTAL OR CONSEQUENTIAL DAMAGES SO THE ABOVE LIMITATIONS OR EXCLUSIONS MAY NOT APPLY TO YOU.**

**THE FOREGOING WARRANTY IS IN LIEU OF ALL OTHER WARRANTIES, EXPRESS OR IMPLIED, INCLUDING THOSE OF MERCHANTABILITY, FITNESS FOR ANY PARTICULAR PURPOSE OR INFRINGEMENT. ORIGINAL PURCHASER SHALL IN NO EVENT BE ENTITLED TO, AND PARROT UNCLE SHALL NOT BE LIABLE FOR, INDIRECT, SPECIAL, INCIDENTAL OR CONSEQUENTIAL DAMAGES OF ANY NATURE, INCLUDING, BUT NOT LIMITED TO LOSS OF PROFIT, PROMOTIONAL AND/OR MANUFACTURING EXPENSES, OVERHEAD, INJURY TO REPUTATION AND/OR LOSS OF CUSTOMERS.**