



# User Manual

## Full HD 180-Degree Wi-Fi Network Camera

DCS-2530L

---

# Preface

D-Link reserves the right to revise this publication and to make changes in the content hereof without obligation to notify any person or organization of such revisions or changes. Information in this document may become obsolete as our services and websites develop and change.

## Manual Revisions

Revision	Date	Description
1.00	04/22/2016	DCS-2530L Revision A1 with firmware version 1.00
1.01	09/23/2016	Update technical specifications
1.02	11/08/2016	Updated for firmware 1.00.21

## Trademarks

D-Link and the D-Link logo are trademarks or registered trademarks of D-Link Corporation or its subsidiaries in the United States or other countries. All other company or product names mentioned herein are trademarks or registered trademarks of their respective companies.

Copyright © 2016 D-Link Corporation.

All rights reserved. This publication may not be reproduced, in whole or in part, without prior expressed written permission from D-Link Corporation.

---

# Table of Contents

<b>Product Overview</b> .....	<b>4</b>	Sound Detection.....	34
Package Contents.....	4	Time and Date.....	35
System Requirements.....	4	Event Setup.....	36
Introduction.....	5	SD Card.....	44
Features.....	5	Advanced.....	45
Hardware Overview.....	6	ICR and IR.....	45
Front View.....	6	HTTPS.....	46
Rear View.....	7	Access List.....	47
<b>Installation</b> .....	<b>8</b>	Maintenance.....	48
Wireless Installation Considerations.....	9	Admin.....	48
Mobile App Setup.....	10	System.....	49
Zero Configuration Setup.....	11	Firmware Upgrade.....	50
Mounting the Camera.....	14	Status.....	51
mydlink.....	16	Device Info.....	51
<b>Configuration</b> .....	<b>17</b>	Log.....	52
Accessing the Web Configuration Utility.....	17	Help.....	53
Live Video.....	18	<b>Technical Specifications</b> .....	<b>54</b>
Setup.....	20	<b>Contacting Technical Support</b> .....	<b>56</b>
Setup Wizard.....	20	<b>Warranty</b> .....	<b>57</b>
Network Setup.....	25	<b>Registration</b> .....	<b>62</b>
Wireless Setup.....	28		
Dynamic DNS.....	29		
Image Setup.....	30		
Audio and Video.....	32		
Motion Detection.....	33		

# Product Overview

## Package Contents

- DCS-2530L Full HD 180-Degree Wi-Fi Network Camera
- Power Adapter
- Mounting Kit
- Quick Installation Guide
- Quick Install Card

**Note:** Using a power supply with a different voltage than the one included with your product will cause damage and void the warranty for this product.

If any of the above items are missing, please contact your reseller.

## System Requirements

- 802.11n/g Wi-Fi router
- A broadband Internet connection
- iPhone, iPad, Android, or Windows smartphone or tablet (please refer to the mobile app's store page to check whether your device is compatible)

# Introduction

The DCS-2530L Full HD 180-Degree Wi-Fi Network Camera boasts an ultra-wide 180° horizontal lens that easily captures your entire room, wall-to-wall, in high-quality 1080p. Its rotatable head makes ceiling installations easy, and the built-in night vision and handy mobile app empower you with knowing exactly what is happening, day or night.

## Features

### **180° Wide Angle Lens**

The DCS-2530L provides whole-room coverage with a 180° wide angle lens, eliminating the need for multiple cameras to cover a single room. Built-in dewarping technology automatically corrects the image for you.

### **1080p Full HD Video**

The 1080p Full HD sensor provides crisp detail and clarity for high-quality snapshots and video.

### **Comprehensive Day/Night Surveillance**

The infrared LEDs enable night time viewing of up to 16 feet (5 meters), while the motion sensor and built-in microphone detects nearby motion and sound anytime day or night. The microSD card slot allows the camera to record snapshots and video directly to onboard storage for a complete surveillance solution.

### **Wireless N Connectivity**

The DCS-2530L uses high-speed Wireless N to connect to your wireless router, and is compatible with 802.11n/g.

### **Web Configuration**

In addition to the mydlink mobile app, you can use a standard web browser to configure and manage the DCS-2530L through the mydlink website, and access your DCS-2530L anytime, anywhere in the world from virtually any device.

## Hardware Overview

### Front View



## Rear View



# Installation

There are two ways to set up your camera:

**mydlink Lite Mobile App:** You can use the mydlink Lite mobile app to guide you through setup and initial configuration of your camera. Refer to "**Mobile App Setup**" on page 10.

**Zero Configuration Setup:** If you have a mydlink-enabled router (D-Link Wi-Fi router), this is the easiest way to set up your camera. Refer to "**Zero Configuration Setup**" on page 11.

**Note:** To ensure your product has the latest security updates and operates at optimal performance, it is recommended you update your product to the latest firmware after installation and to periodically check for new firmware releases. Updates can be found by searching your model name at <http://support.dlink.com> or through the mydlink mobile apps for mydlink registered devices.

## Wireless Installation Considerations

The DCS-2530L connects to your network using a wireless connection from anywhere within the operating range of your wireless network. However, the number, thickness and location of walls, ceilings, or other objects that the wireless signals must pass through, may limit the range. Typical ranges vary depending on the types of materials and background RF (radio frequency) noise in your home or business. The key to maximizing wireless range is to follow these basic guidelines:

1. Minimize the number of walls and ceilings between your adapter and other network devices (such as your Network Camera) - each wall or ceiling can reduce your adapter's range from 3-90 feet (1-30 meters).
2. Be aware of the direct line between network devices. A wall that is 1.5 feet thick (.5 meters), at a 45-degree angle appears to be almost 3 feet (1 meter) thick. At a 2-degree angle, it looks over 42 feet (14 meters) thick. Position your devices so that the signal will travel straight through a wall or ceiling (instead of at an angle) for better reception.
3. Building materials make a difference. A solid metal door or aluminum studs may weaken the wireless signal. Try to position your access points, wireless routers, and other networking devices where the signal passes through drywall or open doorways. Materials and objects such as glass, steel, metal, walls with insulation, water (fish tanks), mirrors, file cabinets, brick, and concrete will degrade your wireless signal.
4. Keep your product at least 3-6 feet or 1-2 meters away from electrical devices or appliances that generate RF noise.
5. If you are using 2.4 GHz cordless phones or other radio frequency sources (such as microwave ovens), your wireless connection may degrade dramatically or drop completely. Make sure your 2.4 GHz phone base is as far away from your wireless devices as possible. The base transmits a signal even if the phone is not in use.

## Mobile App Setup

You can configure your camera through the mydlink Lite mobile app. On your mobile device, download mydlink Lite by searching for **mydlink Lite** in the iTunes App Store, Google Play, or the Windows Store.



Launch the mydlink Lite app and create a new account or sign in to your existing account. Follow the onscreen instructions to set up your camera.

When you are asked to scan a QR code, use the code on the Quick Install Card in your package, or on the label attached to your device.

Congratulations, your DCS-2530L is now ready to use! Be sure to accept any firmware update to keep your product secure and up to date with the latest features.

## Zero Configuration Setup

**If you have a mydlink-enabled Wi-Fi Router**, you can take advantage of Zero Configuration Setup. Zero Configuration automatically configures your camera's settings for you, and adds the camera to your mydlink account automatically. This type of setup allows you to set up your camera by simply plugging it in and connecting it to your router.

Connect your camera to your mydlink-enabled Wi-Fi router and Zero Configuration will automatically configure your DCS-2530L and add the camera to your mydlink account. After the short time it takes to do this you can remotely access your camera from the website (<http://www.mydlink.com>) or the mydlink app to manage and monitor your DCS-2530L.

### Plug in the External Power Adapter

Connect the power adapter to the microUSB port on the back of the camera. Plug the power adapter in to a wall outlet.

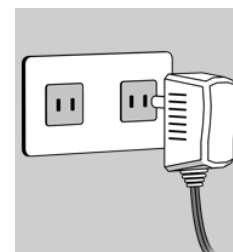

### Press the WPS button on your camera

Press and hold the WPS button for three seconds. The blue WPS status LED will start blinking.



### Press the WPS button on your Wi-Fi Router

Press the WPS button on your router within 60 seconds. The WPS button is usually on the side or back of your Wi-Fi router. The DCS-2530L will automatically create a secure wireless connection to your router and reboot. When it has successfully connected, the Power LED will be lit green and the Direct LED will be turned off.

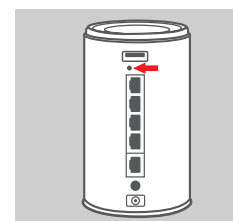

## Check Your mydlink Account

From any computer with an Internet connection, open a web browser and login to your mydlink account. The mydlink page will check for new devices and display a **New device Found!** pop-up notification in the bottom left corner. Click the notification to continue.

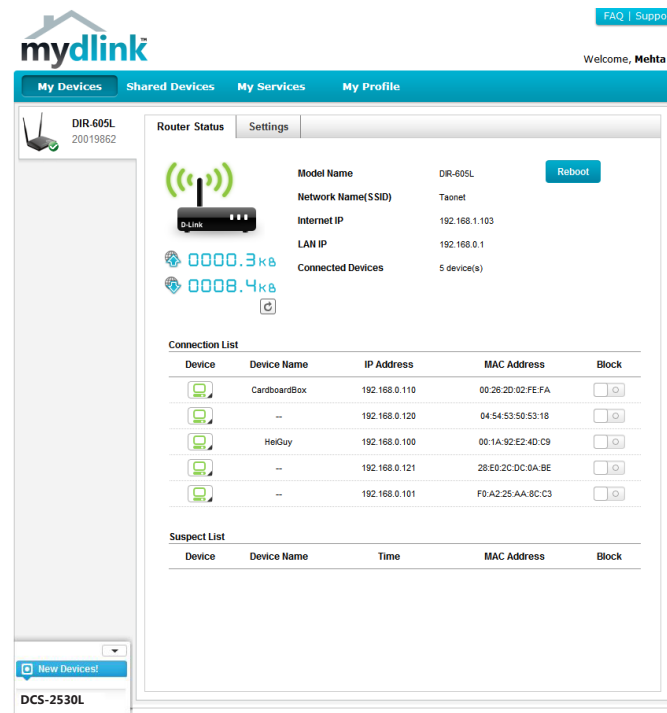

A summary and confirmation notification will appear with the automatically configured details. Make a note of the details and click **Yes** to add the camera to your account.

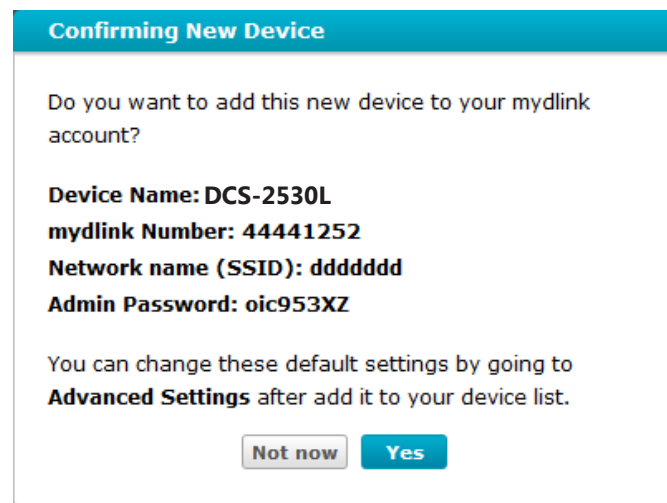

## Section 2: Installation

Zero Configuration will navigate to the mydlink *Live View* tab for your camera where you will see a screen similar to the following.

Your camera is now set up, and you can skip to **"mydlink" on page 16** to learn more about the mydlink features of this camera, or to **"Configuration" on page 17** for advanced configuration of your camera.

**Note:** If you see a white haze when viewing in night vision mode, the night vision light on the camera may be reflecting off a nearby surface. Try repositioning and aiming the camera.



## Mounting the Camera

To mount your camera on a wall or ceiling, please follow the steps below. It is recommended that you configure the camera before mounting.

### Step 1

Rotate the baseplate counter-clockwise and remove it.

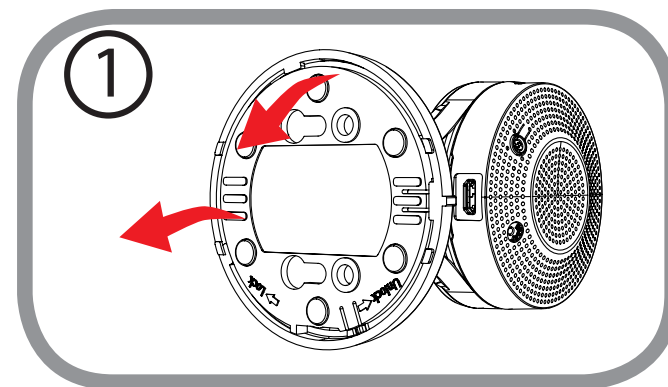

### Step 2

Place the baseplate where you want to position the camera and use a pencil to mark the holes. You can use the lower holes for a removable installation, or the top holes for a fixed one. Make sure that the arrow on the baseplate is pointing up.

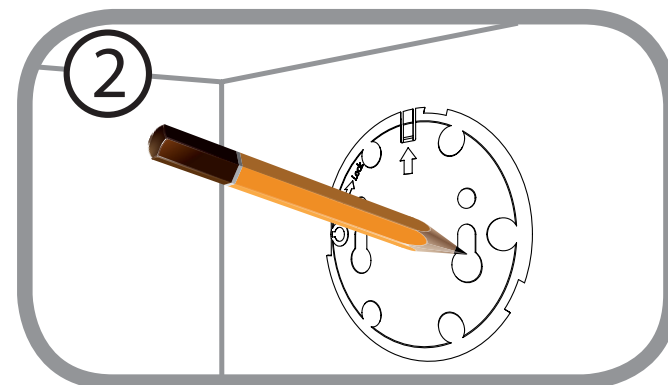

### Step 3

Depending on the material of the wall or ceiling, use proper tools to drill holes 25 mm deep with a 6 mm drill bit where you marked. If the wall is made out of concrete, drill the holes first, then insert the plastic anchors to support the screws.

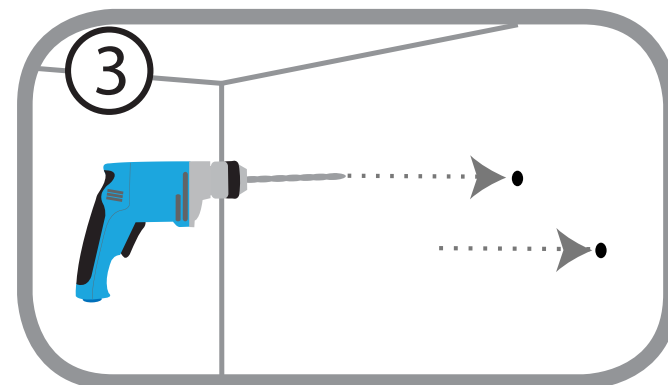

## Section 2: Installation

### Step 4

Place the baseplate over the holes that are in the wall. Make sure to align the baseplate holes with the holes in the wall. Use the supplied screws to attach the baseplate to the surface of the wall.

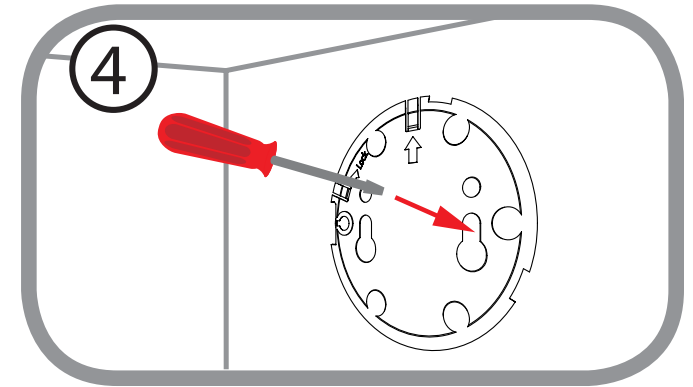

### Step 5

Place the camera over the baseplate with the alignment nub pointing left, then attach the camera by rotating it until the alignment nub points up.

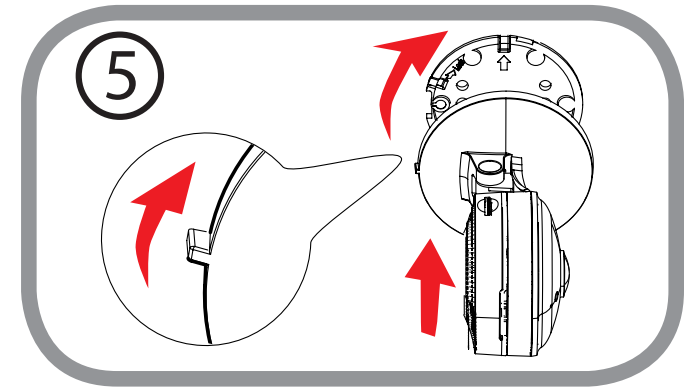

### Step 6

Adjust the angle and rotation of the camera as desired. You can also rotate the camera on the baseplate about 45° to the right or left.

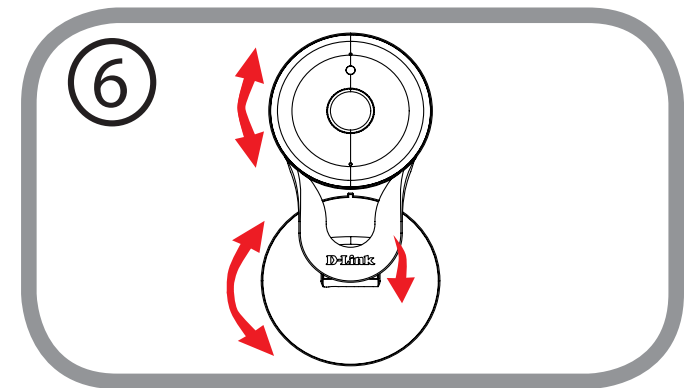

# mydlink

After registering your camera with a mydlink account, you will be able to remotely access your camera from the [www.mydlink.com](http://www.mydlink.com) website. After signing in to your mydlink account, you will see a screen similar to the following:

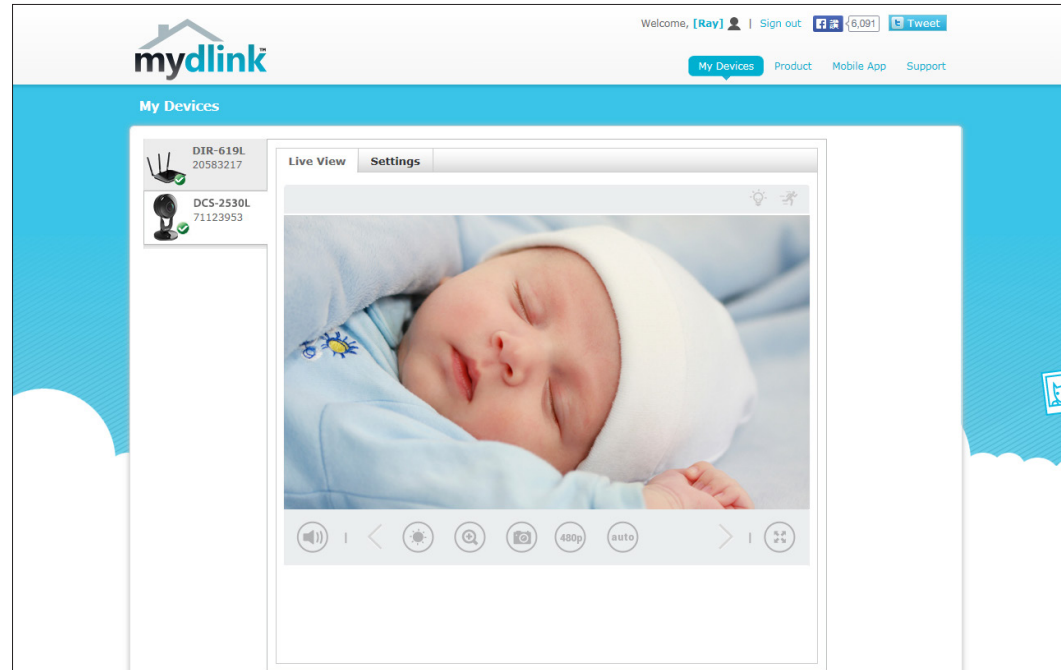

# Configuration

## Accessing the Web Configuration Utility

After completing the Camera Installation Wizard, you are ready to use your camera. The camera's built-in Web configuration utility is designed to allow you to easily access and configure your DCS-2530L. At the end of the wizard, click **Go To Camera**, or enter the IP address of your camera into a web browser, such as Internet Explorer®. To log in, use the user name **admin** and the password you created in the Installation Wizard. If you did not create a password, the default password is blank. After entering your password, click **OK**.

**Note:** If you are directly connecting your PC to the camera, or if you are using the camera on a closed network, the default IP is **192.168.0.20**.

Please make sure that you have the latest version of Java application installed on your computer to ensure proper operation when viewing the video in Java mode. The Java application can be downloaded at <http://www.java.com>.

When you connect to the home page of your camera, you may be prompted to download ActiveX. If you want to use ActiveX to view your video images instead of Java, then you must download ActiveX.

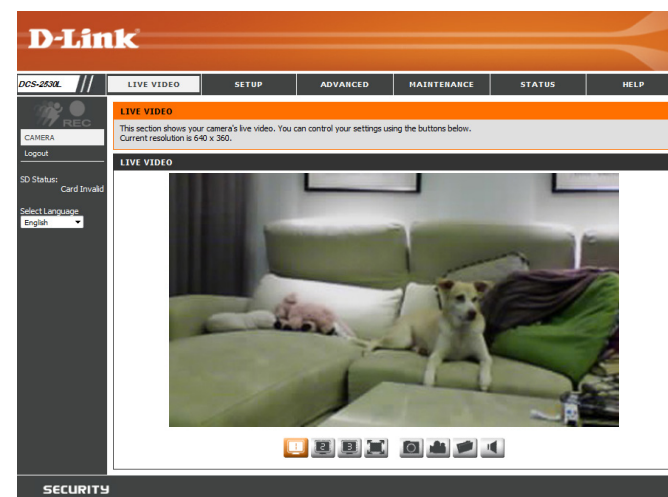
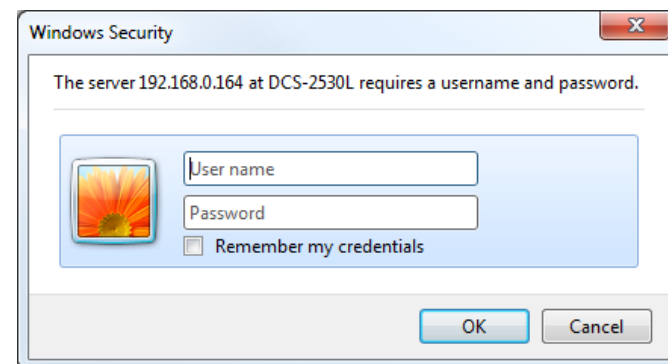







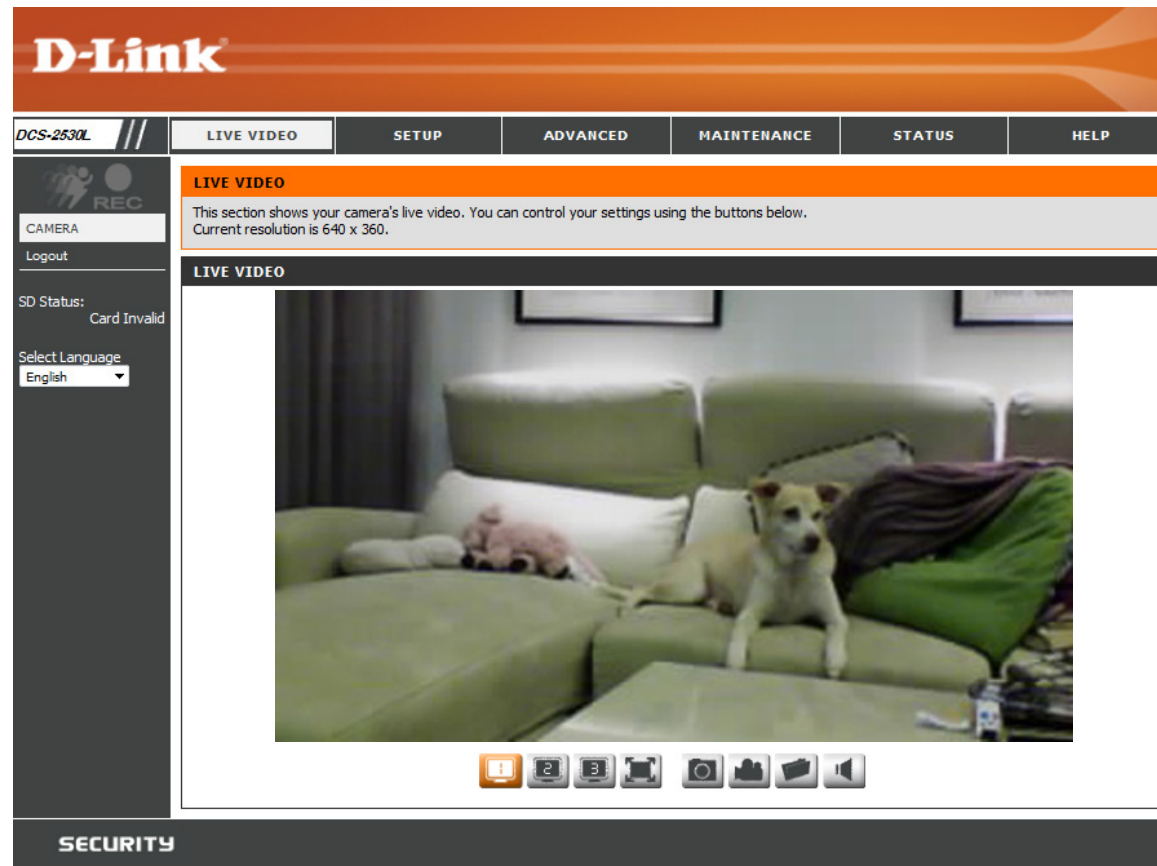

# Live Video

The Live Video page lets you view the live video stream from your camera.

Please make sure that you have the latest version of Java installed on your computer to ensure proper operation when viewing the video in Java mode. The Java application can be downloaded free from <http://www.java.com>.



## Section 3: Configuration

Icon	Button Name	Function
	Event Trigger Indicator	This indicator will change color when a trigger event occurs, such as when motion or sound is detected.
	Recording Indicator	When a recording is in progress, this indicator will change color.
	Profile buttons	Use these buttons to switch between video profiles. Refer to <b>"Audio and Video" on page 32</b> for more information on setting up profiles.
	Full Screen button	Switches to a full screen view of the camera video.
	Snapshot button	Takes a snapshot of the image currently displayed on the screen and saves it to the hard drive in the folder specified using the Storage folder button.
	Video recording button	Triggers the camera's recording function. This will record the video displayed on the screen and saves it to the hard drive in the folder specified using the Storage folder button.
	Storage folder button	Sets the storage folder for snapshots and video recordings.
	Listen button	Sends the audio received from the camera's microphone through to the PC's speakers.

# Setup

## Setup Wizard

This section allows you to begin setup wizards which will guide you through the process of getting your camera's various functions configured. If you comfortable with adjusting the settings manually, you may skip the wizards and adjust settings manually as needed.

**Internet Connection Setup Wizard:** You may choose to configure your camera's Internet connection by using the Internet Connection Setup Wizard that includes step-by-step instructions. Please refer to **"Internet Connection Setup Wizard" on page 21** for more details.

**Manual Internet Connection Setup:** If you would rather manually set up the camera's Internet connection, you can refer to **"Network Setup" on page 25** which provides more details on the information required.

**Motion Detection Setup Wizard:** You may choose to configure motion detection by using the Motion Detection Setup Wizard that includes step-by-step instructions. Please refer to **"Motion Detection Setup Wizard" on page 23** for more details.

**Manual Motion Detection Setup:** If you would rather manually set up the camera's motion detection features, you can refer to **"Motion Detection" on page 33** which provides more details on the information required.

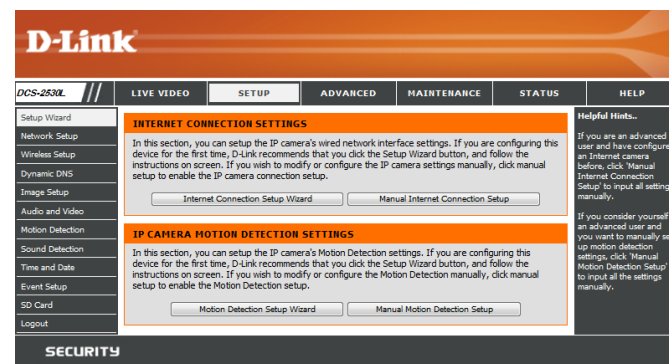

## Internet Connection Setup Wizard

This wizard will guide you through a step-by-step process to configure your new D-Link Camera and connect the camera to the Internet. Click **Next** to continue.

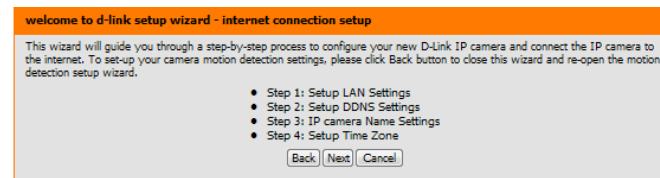

Select how the camera will connect to the Internet.

If your camera is connected to a router, or you are unsure how your camera will connect to the Internet, select **DHCP**.

Select **Static IP Client** if your Internet Service Provider has provided you with connection settings, or if you wish to set a static address within your home network. Enter the correct configuration information and click **Next** to continue.

If you are using PPPoE, select **Enable PPPoE** and enter your user name and password.

Click **Next** to continue.

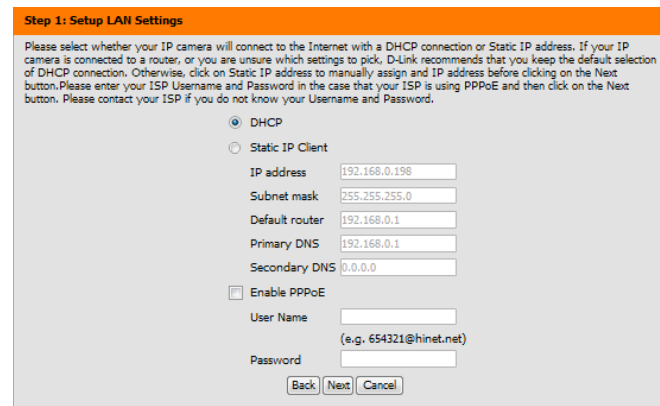

## Section 3: Configuration

If you have a Dynamic DNS account and would like the camera to update your IP address automatically, Select **Enable DDNS** and enter your host information. Click **Next** to continue.

**Step 2: Setup DDNS Settings**

If you have a Dynamic DNS account and would like the IP camera to update your IP address automatically, enable DDNS and enter in your host information below. Please click on the Next button to continue.

Enable DDNS

Server Address  <<

Host Name

User Name

Password

Verify Password

Timeout  (hours)

Enter a name for your camera and click **Next** to continue.

**Step 3: IP camera Name Settings**

D-Link recommends that you rename your IP camera for easy accessibility. You can then identify and connect to your IP camera via this name. Please assign a name of your choice before clicking on the Next button.

IP camera Name

Configure the correct time to ensure that all events will be triggered as scheduled. Click **Next** to continue.

**Step 4: Setup Time Zone**

Please configure the correct time to ensure that all events are triggered, captured and scheduled at the correct time and day and then click on the Next button.

Time Zone

Enable Daylight Saving

If you have selected DHCP, you will see a summary of your settings, including the camera's IP address. Please write down all of this information as you will need it in order to access your camera.

Click **Apply** to save your settings.

**Step 5: Setup complete**

Below is a summary of your IP camera settings. Click on the Back button to review or modify settings or click on the Apply button if all settings are correct. It is recommended to note down these settings in order to access your IP camera on the network or via your web browser.

IP Address	DHCP
IP camera Name	DCS-2530L
Time Zone	(GMT+08:00) Taipei
DDNS	Disable
PPPoE	Disable

## Motion Detection Setup Wizard

This wizard will guide you through a step-by-step process to configure your camera's motion detection functions.

Click **Next** to continue.

### Step 1

This step will allow you to enable or disable motion detection, specify the detection sensitivity, and adjust the camera's ability to detect movement.

You may specify whether the camera should capture a snapshot or a video clip when motion is detected.

Refer to "Motion Detection" on page 33 for information about how to configure motion detection.

### Step 2

This step allows you to enable motion detection based on a customized schedule. Specify the days and hours to enable motion detection. You may also choose to always record whenever motion is detected.

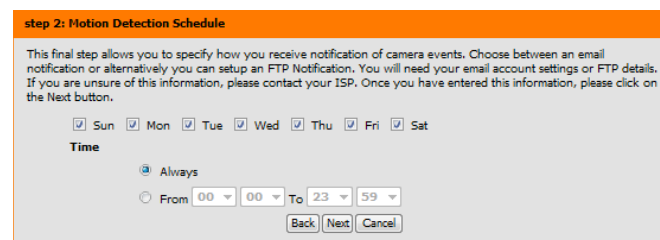
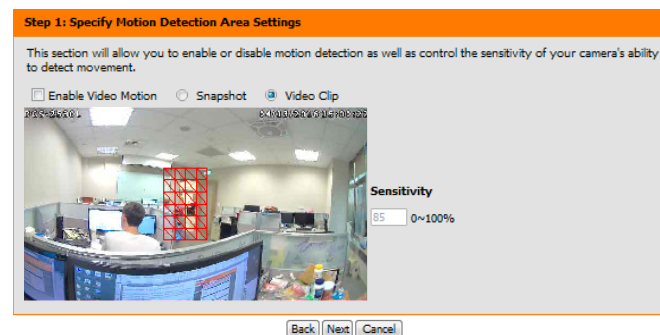
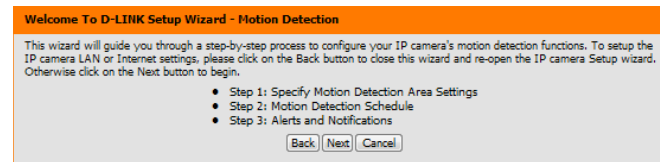

## Section 3: Configuration

### Step 3

This step allows you to specify how you will receive event notifications from your camera. You may choose not to receive notifications, or to receive notifications via e-mail.

Please enter the relevant information for your e-mail account.

Click **Next** to continue.

**Step 3: Alerts and Notification**

This final step allows you to specify how you receive notification of camera events. Choose between an email notification. You will need your email account settings. If you are unsure of this information, please contact your ISP. Once you have entered this information, please click on the Next button.

Do not notify me

Email

Sender email address	test@test.com
Recipient email address	test@test.com
Server address	test@test.com
User name	
Password	
Port	25

This server requires a secure connection (StartTLS)

### Step 4

You have completed the Motion Detection Wizard.

Please verify your settings and click **Apply** to save them.

**Step 4: Setup Complete**

You have completed your IP camera setup. Please click the Back button if you want to review or modify your settings or click on the Apply button to save and apply your settings.

Motion Detection :	Disable
EVENT :	Video Clip
Schedule Day :	Sun , Mon , Tue , Wed , Thu , Fri , Sat ,
Schedule Time :	Always
Alerts and Notification :	Do not notify me

Please wait a few moments while the camera saves your settings and restarts.

**Step 4: Setup Complete**

You have completed your IP camera setup. Please click the Back button if you want to review or modify your settings or click on the Apply button to save and apply your settings.

Changes saved.IP camera's network is restarting, please wait for 6 seconds ...

# Network Setup

Use this section to configure the network connections for your camera. All relevant information must be entered accurately. After making any changes, click the **Save Settings** button to save your changes.

**LAN Settings:** This section lets you configure settings for your local area network.

**DHCP:** Select this connection if you have a DHCP server running on your network and would like your camera to obtain an IP address automatically.

If you choose DHCP, you do not need to fill out the IP address settings.

**Static IP Client:** You may obtain a static or fixed IP address and other network information from your network administrator for your camera. A static IP address may simplify access to your camera in the future.

**IP Address:** Enter the IP address that the camera will use on your network. You may need to get this information from your ISP or network administrator.

**Subnet Mask:** Enter the subnet mask that your camera will use on the network. The default value is "255.255.255.0." This is used to determine if the destination is part of the same subnet.

**Default Router:** Enter the address of the router or gateway your camera will use on the network. The gateway is used to forward frames to destinations in a different subnet. Invalid gateway settings may cause transmissions to a different subnet to fail.

**Primary DNS:** Enter the primary domain name server that translates names to IP addresses.

**Secondary DNS:** Enter the secondary domain name server used to back up the Primary DNS.

**Helpful Hints...**

Select DHCP Connection if you are running a DHCP server on your network and would like an IP address assigned to your IP camera automatically.

**UPnP:** Enabling UPnP settings will allow you to configure your IP camera as an UPnP device in the network.

**PPPoE Setting:** If you use the IP camera to connect directly to the Internet, you will need to enter the username and password, which were given to you when you set up your account with your Internet Service Provider. If the camera is behind a router or a gateway, you do not need to configure the settings.

**HTTP:** HTTP Port is the port you allocate in order to connect to the IP camera via a standard web browser.

**HTTPS:** HTTPS Port in a IP camera connects it with a PC via a secure web browser.

**RTSP:** RTSP Port is the port you allocate in order to connect to a IP camera by using streaming media device(s), such as a mobile phone or PDA.

**CoS (Class of Service):** CoS is a traffic control based on the L2 protocol. Class of Service technologies do not guarantee a level of service in terms of bandwidth and delivery time, they offer a "best-effort".

**QoS (Quality of Service):** Prioritized traffic control, a resource reservation control mechanism. Quality of service guarantees are important if the network capacity is insufficient, especially for real-time streaming multimedia applications.

**Enable IPv6:** Select this option and click Save to enable IPv6 settings. Please note that this only works if your network environment and hardware equipment support IPv6. The browser should be Microsoft® Internet Explorer 8.5, Mozilla Firefox 3.0 or above. When IPv6 is enabled, by default, the Network Camera will listen to router advertisements and be assigned a link-local IPv6 address accordingly. IPv6 address accordingly.

**IPv6 Information:** Click this button to obtain the IPv6 information. If your IPv6 settings are successful, the IPv6 address list will be listed in

**Enable UPnP Presentation:** Enabling this setting allows your camera to be configured as a UPnP device on your network.

**Enable UPnP Port Forwarding:** Enabling this setting allows the camera to add port forwarding entries into the router automatically on a UPnP capable network.

**Enable PPPoE:** Enable this setting if your network uses PPPoE.

**User Name / Password:** Enter the username and password for your PPPoE account. Re-enter your password in the Confirm Password field. You may obtain this information from your ISP.

**HTTP Port:** Enter the port to use for HTTP access to the camera. The default port number is 80.

**Access Name for Stream 1~3:** Enter a name to use for HTTP streaming access. The default name is video#.mjpeg, where # is the number of the stream.

**HTTPS Port:** Enter the port to use for HTTPS access to the camera. You may use a PC with a secure browser to connect to the HTTPS port of the camera. The default port number is 443.

**RTSP Port:** Enter the port number to use for RTSP streaming to mobile devices. The default port number is 554. You may specify the address of a particular stream. For instance, live1.sdp can be accessed at rtsp://x.x.x.x/live1.sdp where the x.x.x.x represents the IP address of your camera.

**Enable CoS:** Enabling CoS allows you to specify the Class of Service for different types of traffic so you can prioritize their transmission on your network. CoS helps provide prioritization for Layer 2 traffic.

The screenshot displays the configuration web interface for the camera, organized into several sections:

- LAN SETTINGS:**
  - DHCP
  - Static IP Client
    - IP address: 192.168.0.164
    - Subnet mask: 255.255.255.0
    - Default router: 192.168.0.1
    - Primary DNS: 192.168.0.1
    - Secondary DNS: 0.0.0.0
  - Enable UPnP presentation
  - Enable UPnP port forwarding
    - Forwarding Port: 1024
    - Forwarding Status: UPnP forwarding is inactive
- PPPOE SETTINGS:**
  - Enable  Disable
  - User Name: [text input]
  - Password: [text input]
  - Confirm password: [text input]
  - PPPoE Status: PPPoE is inactive.
- HTTP:**
  - HTTP port: 80
  - Access name for stream1: video1.mjpeg
  - Access name for stream2: video2.mjpeg
  - Access name for stream3: video3.mjpeg
- HTTPS:**
  - HTTPS port: 443
- RTSP:**
  - Authentication: Digest
  - RTSP port: 554
  - Access name for stream1: live1.sdp
  - Access name for stream2: live2.sdp
  - Access name for stream3: live3.sdp
- COS SETTINGS:**
  - Enable CoS
  - VLAN ID: 1 [0~4095]
  - Live video: 0
  - Live audio: 0
  - Event/Alarm: 0
  - Management: 0
- QOS SETTINGS:**
  - Enable QoS
  - Live video: 0
  - Live video: 0
  - Live audio: 0
  - Event/Alarm: 0
  - Management: 0

**Enable QoS:** Enabling QoS allows you to specify the Quality of Service for different types of traffic so you can prioritize their transmission on your network. QoS helps provide prioritization for Layer 3 traffic. If the camera is connected to a router that itself implements QoS, the router's settings will override the QoS settings of the camera.

**Enable IPv6:** Select **Enable IPv6** to automatically get an IPv6 address from your router. If you have a static or fixed IP from your network administrator, select Static IP address and enter the information provided by your ISP or network administrator.

**Enable Multicast for stream:** The DCS-2530L allows you to multicast each of the available streams via a group address and lets you specify the TTL value for each stream. Enter the ports and TTL settings you wish to use if you do not want to use the defaults.

**Enable Bonjour:** Enable this to allow other network devices to connect to this camera using Bonjour.

**Bonjour Name:** Enter a name to use to identify this camera through Bonjour.

**QOS SETTINGS**

Enable QoS
 

Live video	0	▼
Live video	0	▼
Live audio	0	▼
Event/Alarm	0	▼
Management	0	▼

**IPv6**

Enable IPv6
 

IPv6 Information

 Manually setup the IP address
 

Optional IP address / Prefix length			/	
Optional default router				
Optional primary DNS				

**MULTICAST**

Enable multicast for stream 1
 

Multicast group address	239.1.1.1
Multicast video port	6550
Multicast RTCP video port	6551
Multicast audio port	6552
Multicast audio port	6552
Multicast RTCP audio port	6553
Multicast TTL [1~255]	64

  
 Enable multicast for stream 2
 

Multicast group address	239.1.1.2
Multicast video port	6554
Multicast RTCP video port	6555
Multicast audio port	6556
Multicast RTCP audio port	6557
Multicast TTL [1~255]	64

  
 Enable multicast for stream 3
 

Multicast group address	239.1.1.3
Multicast video port	6558
Multicast RTCP video port	6559
Multicast audio port	6560
Multicast RTCP audio port	6561
Multicast TTL [1~255]	64

**BONJOUR SETTINGS**

Enable Bonjour
 

Bonjour Name	DCS-2530L_17D5EB	32 characters maximum
(Characters you may use in a Bonjour Name: "upper or lower case letters", "numbers" and "hyphens".)		

## Wireless Setup

This section allows you to set up and configure the wireless settings on your camera.

**Site Survey:** The drop-down menu lists all the wireless networks that the camera was able to detect. Click **Rescan** to scan for wireless networks again.

**SSID:** Type in an SSID name to connect the camera to a wireless network.

**Wireless Mode:** This shows the current wireless mode being used by the camera.

**Channel:** In Ad-Hoc wireless mode, you can the wireless channel you wish the camera to operate on.

**Authentication:** For security, you can choose **Open**, **Shared**, or **WPA-PSK / WPA2-PSK**. Select the same encryption method that is being used by your wireless device/router.

**Encryption:** If you chose **WPA-PSK** or **WPA2-PSK**, choose whether to use **TKIP** or **AES**.

**Key:** Enter the key (password) for your wireless network.

Click the **Save Settings** button to save your changes.

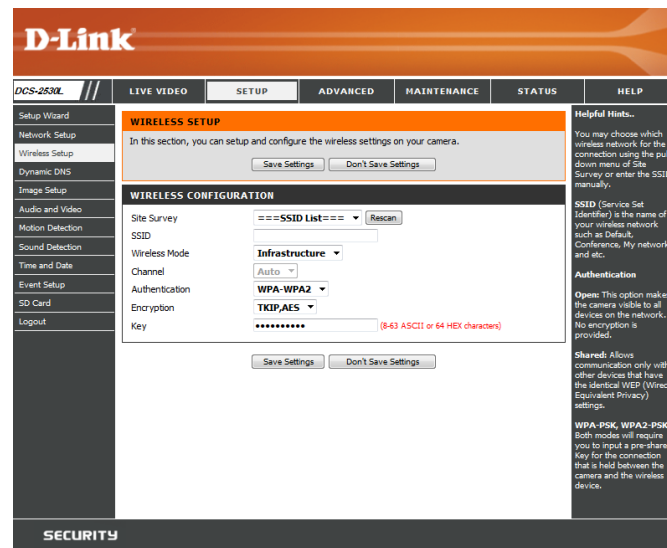

## Dynamic DNS

DDNS allows you to access your camera using a domain name instead of an IP address. To do this, you will need to have an account with one of the DDNS services listed in the drop-down box on this page.

**Enable DDNS:** Select this checkbox to enable the DDNS function.

**Server Address:** Select your Dynamic DNS provider from the drop-down menu or enter the server address manually.

**Host Name:** Enter the host name of the DDNS server.

**User Name:** Enter the user name or e-mail used to connect to your DDNS account.

**Password:** Enter the password used to connect to your DDNS account. Enter it again in the *Verify Password* field.

**Timeout:** Enter the DNS timeout values you wish to use.

**Status:** This indicates the connection status, which is automatically determined by the system.

The screenshot shows the D-Link web interface for the DCS-2530L camera. The page is titled "DYNAMIC DNS" and includes a "Helpful Hints..." section on the right. The main content area is titled "DYNAMIC DNS SETTING" and contains the following fields:

- Enable DDNS:** A checkbox that is checked.
- Server Address:** A dropdown menu with "www.DynDNS.org" selected and a "<<" button to the left.
- Host Name:** A text input field.
- User Name:** A text input field.
- Password:** A text input field.
- Verify Password:** A text input field.
- Timeout:** A text input field with "24" and "(hours)" next to it.
- Status:** A text input field with "Active" next to it.

At the bottom of the form are "Save Settings" and "Don't Save Settings" buttons. The page also features a "SECURITY" banner at the bottom.

# Image Setup

In this section, you can configure the video image settings for your camera.

**Enable Privacy Mask Setting:** The Privacy Mask setting allows you to specify up to 3 rectangular areas on the camera's image to be blocked/excluded from recordings and snapshots.

You may click and drag the mouse cursor over the camera image to draw a mask area. Right-clicking on the camera image brings up the following menu options:

- **Disable All:** Disables all mask areas
- **Enable All:** Enables all mask areas
- **Reset All:** Clears all mask areas.

**Mirror:** This will mirror the image horizontally.

**Flip:** This will flip the image vertically. If the camera is installed upside down, Flip and Mirror should both be checked.

**Anti Flicker:** Select the frequency used by your power lines to avoid interference or distortion.

**White Balance:** Use the drop-down box to change white balance settings to help balance colors for different environments. You can choose from **Auto**, **Outdoor**, **Indoor**, and **Fluorescent**.

**Exposure Mode:** Changes the exposure mode. Use the drop-down menu to set the camera for **Outdoor**, **Indoor**, or **Night** environments, or to Moving to capture moving objects. The **Low Noise** option will focus on creating a high-quality picture with reduced noise when monitoring low-light environments. You can also create three different custom exposure modes that let you set the minimum and maximum shutter speeds. The **Max Gain** setting will allow you to control the maximum amount of gain to apply to brighten the picture.

**D-Link**

DCS-2530L // LIVE VIDEO SETUP ADVANCED MAINTENANCE STATUS HELP

**IMAGE SETUP**  
Changes to your IP camera settings are made immediately.

**PRIVACY MASK AREA OF VIDEO SETTING**

Enable Privacy Mask Setting

- Privacy mask: mask 3 privacy area(s) on video.
- Click the right mouse button on the video control to show the popmenu.
- Press the left mouse button, drag and drop to set the privacy area.
- Privacy area can be enabled or disabled.
- After you finish all privacy mask settings, click the Save button.

**IMAGE SETTINGS**

Mirror  On  Off

Flip  On  Off

Anti Flicker  60 Hz  50 Hz

White Balance **Auto**

Exposure Mode **Customize2** Max Gain **36** dB

Shutter Min: **1/30** Max: **1/2**

Denoise **5**

Brightness **100**

Contrast **100**

Saturation **100**

Sharpness **100**

**Helpful Hints...**

**Privacy Mask:** Click the attached box to activate this function. Now use your mouse to draw a rectangle covering the area you want hidden. Click the box again to deactivate the function.

**Mirror:** This function horizontally reverses your images 180 degrees.

**Flip:** This function vertically reverses your images 180 degrees.

**Anti Flicker:** This feature will help to offset the interference of the lighting system and avoid the image flicker issue. ONLY use this option when it is necessary.

**White Balance:** White Balance - Is the process of removing unrealistic color casts, so that objects which appear white in person are rendered white in your photo.

**Exposure Mode:** Exposure is the total amount of light allowed to fall on the image sensor during the process of capturing an image. You may choose different scene modes to produce the better images.

**Max Gain:** It can always be enabled automatically, but you have an option: you can change Max Gain either automatically or manually.

**Denoise:** It is the process of removing noise from a signal.

**Shutter:** If you selected a custom exposure mode, this setting will appear. You can set the minimum and maximum shutter speed (in seconds). Lower shutter speeds will provide brighter images and are suitable for low-light conditions, but moving objects will appear blurry. Higher shutter speeds will provide a clearer picture, but will require more available light. Additionally, if you are using fluorescent lighting, high shutter speeds may cause the video to flicker.

**Denoise:** This setting controls the amount of noise reduction that will be applied to the picture.

**Brightness:** Adjust this setting to compensate for backlit subjects.

**Contrast:** Adjust this setting to alter the color intensity/strength.

**Saturation:** This setting controls the amount of coloration, from grayscale to fully saturated.

**Sharpness:** Specify how much sharpening to apply to the image.

**Reset Default:** Click this button to reset the image settings to the factory defaults.

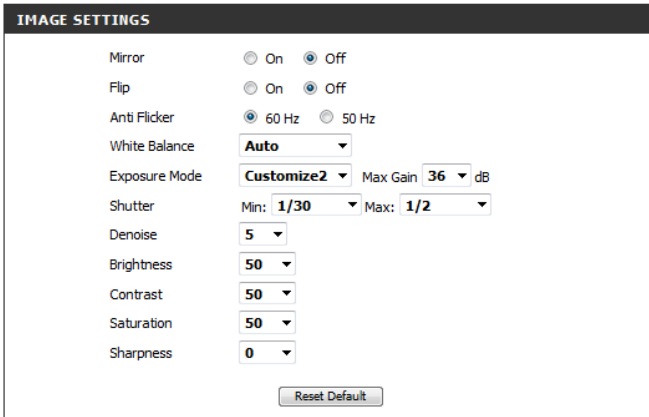

The screenshot shows the 'IMAGE SETTINGS' panel with the following controls:

- Mirror:  On  Off
- Flip:  On  Off
- Anti Flicker:  60 Hz  50 Hz
- White Balance: Auto (dropdown)
- Exposure Mode: Customize2 (dropdown) Max Gain: 36 dB (dropdown)
- Shutter: Min: 1/30 (dropdown) Max: 1/2 (dropdown)
- Denoise: 5 (dropdown)
- Brightness: 50 (dropdown)
- Contrast: 50 (dropdown)
- Saturation: 50 (dropdown)
- Sharpness: 0 (dropdown)

A 'Reset Default' button is located at the bottom right of the panel.

## Audio and Video

You may configure up to three video profiles with different settings for your camera. Hence, you may set up different profiles for your computer and mobile display. After making any changes, click the **Save Settings** button to save your changes.

**Mode:** Set the video codec to be used to JPEG or H.264.

**Frame size:** Frame size determines the total capture resolution the camera will use when viewing and recording video. Higher resolutions provide better video quality, but will require more bandwidth.

**Maximum frame rate:** A higher frame rate provides smoother motion for videos, and requires more bandwidth. Lower frame rates will result in stuttering motion, and require less bandwidth. Please note that if 1920 x 1080 is selected as your frame size, your maximum frame rate will be 15 frames a second at most.

**Video Quality:** This limits the maximum frame rate, which can be combined with the "Fixed quality" option to optimize the bandwidth utilization and video quality. If fixed bandwidth utilization is desired regardless of the video quality, choose "Constant bit rate" and select the desired bandwidth.

**Constant bit rate:** The bps will affect the bit rate of the video recorded by the camera. Higher bit rates result in higher video quality.

**Fixed quality:** Select the image quality level for the camera to try to maintain. High quality levels will result in increased bit rates.

**Audio in off:** Checking this will mute audio picked up by a microphone connected to the audio in jack.

**Audio in gain level:** Specify how much gain to add to audio picked up by a microphone connected to the audio in jack.

The screenshot shows the D-Link DCS-2530L web interface. The main navigation bar includes 'LIVE VIDEO', 'SETUP', 'ADVANCED', 'MAINTENANCE', 'STATUS', and 'HELP'. The 'SETUP' tab is active, and the 'AUDIO AND VIDEO' sub-tab is selected. The page is divided into several sections:

- Helpful Hints..**: Provides information about frame size, frame rate, and video quality, suggesting that higher frame rates and bit rates result in better video quality but require more bandwidth. It also notes that H.264 can use less bandwidth than JPEG but offers better image quality.
- VIDEO PROFILE 1**:
  - Mode: H264
  - Frame size: 640x360
  - Maximum frame rate: 30
  - Video quality: Constant bit rate (selected) or Fixed quality (radio buttons).
- VIDEO PROFILE 2**:
  - Mode: JPEG
  - Frame size: 1920x1080
  - Maximum frame rate: 15
  - Video quality: Excellent
- VIDEO PROFILE 3**:
  - Mode: H264
  - Frame size: 640x360
  - Maximum frame rate: 30
  - Video quality: Constant bit rate (selected) or Fixed quality (radio buttons).
- AUDIO SETTINGS**:
  - Audio in off:
  - Audio in gain level: 5

Buttons for 'Save Settings' and 'Don't Save Settings' are located at the top of the configuration area. A 'Save' button is at the bottom right.

## Motion Detection

Motion detection enables the camera to monitor the video feed for movement. Here, you can specify what part of the image to monitor for motion and adjust the sensitivity settings that determine whether motion is detected by the camera or not. After making any changes, click the **Save Settings** button to save your changes.

**Enable Video Motion:** Select this box to enable the motion detection feature of your camera.

**Note:** If you do not draw an area to monitor for motion, motion will not be detected by the camera.

**Sensitivity:** Specifies how sensitive motion detection will be from 0% to 100%. A low sensitivity setting means that there must be large changes between two images in order to detect motion, and a high sensitivity setting means that even small changes will cause motion to be detected.

**Draw Motion Area:** Use your mouse to click and drag on the areas that you would like to monitor for motion.

**Erase Motion Area:** To erase a motion detection area, simply click on the red square that you wish to remove.

Right-click on the camera image to bring up the following menu options:

**Select All:** Draws a motion detection area over the entire screen.

**Clear All:** Clears any motion detection areas that have been drawn.

**Restore:** Restores the previously specified motion detection areas.

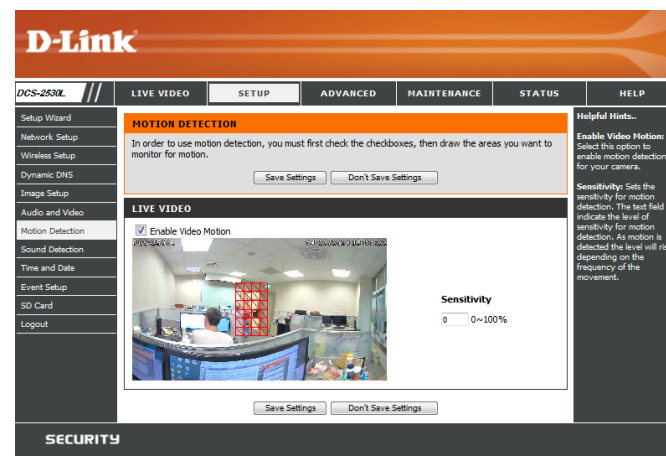

## Sound Detection

Sound detection enables the camera to monitor the environment for loud sounds. You may set the volume threshold used to determine whether sound was detected or not. If this option is selected, the trigger by option under **Video Clip, Snapshot, or SD Recording** should also be selected. For more details, refer to "Event Setup" on page 36.

**Sound Detection:** Select this box to enable the sound detection feature of your camera.

**Detection Level:** Specify the volume level that a sound must exceed in order to trigger the sound detection feature. The lower the number, the more sensitive the camera will be to sound.

Click **Save Settings** to save your changes.

The screenshot displays the D-Link DCS-2530L web interface. The main content area is titled "SOUND DETECTION" and contains the following elements:

- A checkbox labeled "Sound Detection" which is checked.
- A dropdown menu for "Detection Level" currently set to "50".
- A bar chart showing sound levels in dB over time. The y-axis ranges from 40 to 100 dB. The chart shows several peaks, with the highest peak reaching approximately 90 dB.
- Buttons for "Save Settings" and "Don't Save Settings" at the bottom of the chart area.

On the right side, there is a "Helpful Hints..." sidebar with the following text:

**Sound Detection:** Sound Detection detects sound events using the microphone on the camera.

**Detection Level:** Set the Detection Level of sound detection algorithm to trigger sound events. Lower Detection Level makes small sound easier to be detected.

## Time and Date

This section allows you to automatically or manually configure, update, and maintain the internal system clock for your camera. After making any changes, click the **Save Settings** button to save your changes.

**Time Zone:** Select your time zone from the drop-down menu.

**Enable Daylight Saving:** Select this to enable Daylight Saving Time.

**Auto Daylight Saving:** Select this option to allow your camera to configure the Daylight Saving settings automatically.

**Set Date and Time Manually:** Selecting this option allows you to configure the Daylight Saving date and time manually.

**Offset:** Sets the amount of time to be added or removed when Daylight Saving is enabled.

**Start Time / End Time:** Set the date and time to start using and stop using daylight saving.

**Synchronize with NTP Server:** Enable this feature to obtain time automatically from an NTP server.

**NTP Server:** Network Time Protocol (NTP) synchronizes the DCS-2530L with an Internet time server. Choose the one that is closest to your location.

**Set Date and Time Manually:** This option allows you to set the time and date manually.

**Copy Your Computer's Time Settings:** This will synchronize the time information from your PC.

The screenshot shows the D-Link DCS-2530L web interface. The main navigation bar includes 'LIVE VIDEO', 'SETUP', 'ADVANCED', 'MAINTENANCE', 'STATUS', and 'HELP'. The 'SETUP' menu is expanded to show 'TIME AND DATE'. The 'TIME AND DATE' page has a sub-header 'TIME AND DATE' and a 'Helpful Hints...' section on the right. The main content area is divided into three sections:

- TIME CONFIGURATION:**
  - Time Zone: (GMT+08:00) Taipei
  - Enable Daylight Saving:
  - Auto Daylight Saving:
  - Set date and time manually:
  - Offset: +2:00
  - Start time: Month 1, Week 1, Day of week Sunday, Hour 0, Minutes 0
  - End time: Month 1, Week 1, Day of week Sunday, Hour 0, Minutes 0
- AUTOMATIC TIME CONFIGURATION:**
  - Synchronize with NTP Server:
  - NTP Server: pool.ntp.org << Select NTP Server >>
- SET DATE AND TIME MANUALLY:**
  - Set date and time manually:
  - Year: 2016, Month: 1, Day: 29
  - Hour: 15, Minute: 54, Second: 39
  - Copy Your Computer's Time Settings:

At the bottom of the page, there is a 'SECURITY' section.

## Event Setup

The DCS-2530L has a versatile Event system that lets you configure the camera to perform certain actions when an event occurs. For example, when motion is detected, you can have snapshots sent to an e-mail address. You can also configure the camera to take regular video recordings according to a schedule you define.

Before setting up an event, you will need to specify the following:

- **Server:** This is a destination for media to be sent to, such as an e-mail address.
- **Media:** This is the media that will be sent, such as snapshots, video clips, or a system log.

You can then set up Events and Recordings:

- **Event:** This is the actual trigger event that the camera is monitoring for, and the action that it will take. Event triggers include motion detection, loss of network connection, system reboot, and other events.
- **Recording:** This lets you set up a schedule for regular video recording.

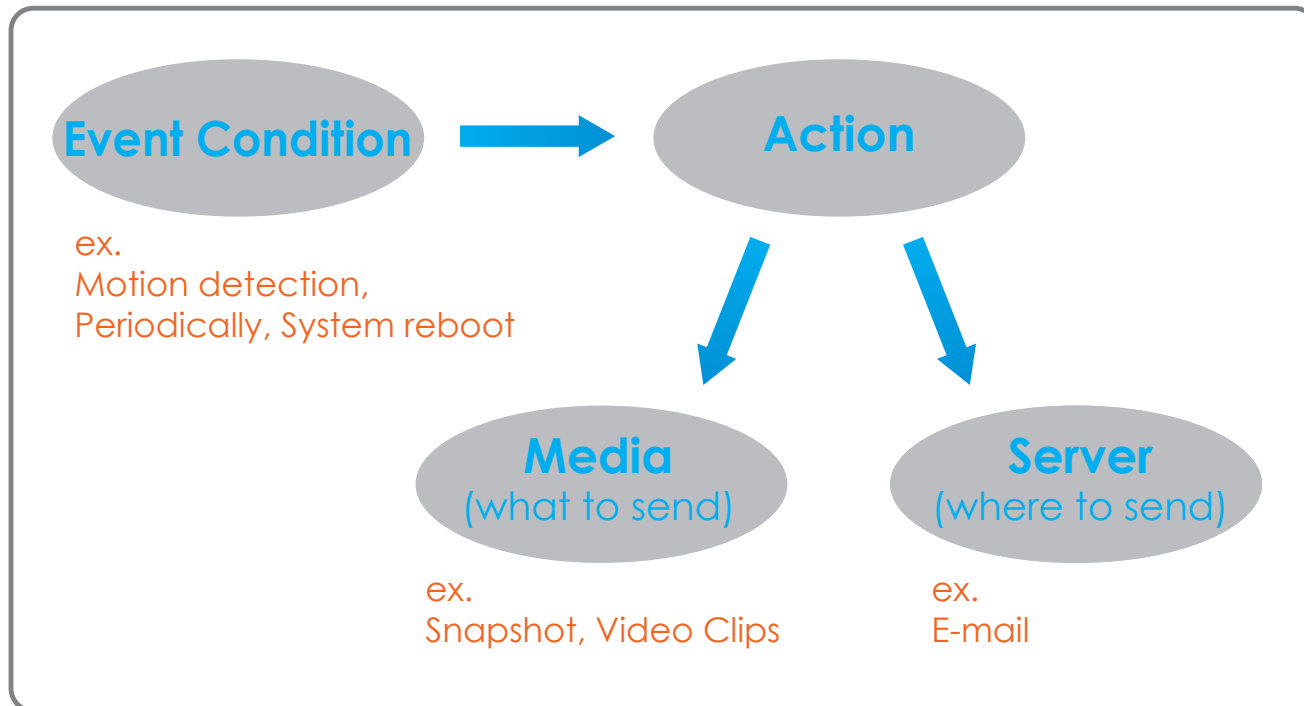

The Event Setup page includes four different sections.

- Server
- Media
- Event
- Recording

1. To add a new server, media, event, or recording item, click **Add**. A screen will appear and allow you to update the fields accordingly.
2. To delete the selected item from the server, media, event, or recording drop-down menus, click the **Delete** button next to it.
3. Click on an item to edit it.

### Add Server

You can configure up to five servers (destinations) to save snapshots and/or video to. After making any changes, click the **Save Settings** button to save your changes.

**Server Name:** Enter the name for the server.

**E-mail:** If you want to use an e-mail address for your server, select this and enter the settings for your target e-mail account.

**SD Card:** Select this to use an inserted microSD card as your server.

The screenshot shows the 'EVENT SETUP' page for a D-Link DCS-2530L camera. The page is divided into four main sections: SERVER, MEDIA, EVENT, and RECORDING. The SERVER section has a table with columns for Name, Type, and Address/Location. The MEDIA section has a table with columns for Name, Type, and Source. The EVENT section has a table with columns for Name, Status, and Time. The RECORDING section has a table with columns for Name, Status, and Time. The page also includes a sidebar with navigation options and a 'Helpful Hints...' section.

The screenshot shows the 'SERVER' configuration page for a D-Link DCS-2530L camera. The page is divided into two main sections: SERVER and SERVER TYPE. The SERVER section has a 'Test' button and 'Save Settings' and 'Don't Save Settings' buttons. The SERVER TYPE section has a radio button for 'Email' and a radio button for 'SD Card'. The 'Email' section has fields for Sender email address, Recipient email address, Server address, User name, Password, and Port. The 'SD Card' section has a checkbox for 'This server requires a secure connection (StartTLS)'. The page also includes a sidebar with navigation options and a 'Helpful Hints...' section.

## Add Media

There are three types of media: **Snapshot**, **Video Clip**, and **System Log**. After making any changes, click the **Save Settings** button to save your changes.

**Media Name:** Enter a unique name for the media you want to create.

**Snapshot:** Select this option to set the media type to snapshots.

**Source:** Set the video profile to use as the media source. Refer to "Audio and Video" on page 32 for more information on video profiles.

**Send pre-event image(s) [0~4]:** Set the number of pre-event images to take. Pre-event images are images taken before the main event snapshot is taken.

**Send post-event image(s) [0~7]:** Set the number of post-event images to take. Post-event images are images taken after the main event snapshot is taken. You can set up to seven post-event images to be taken.

For example:

If both the Send pre-event images and Send post-event images are set to four, a total of 9 images are generated after a trigger is activated.

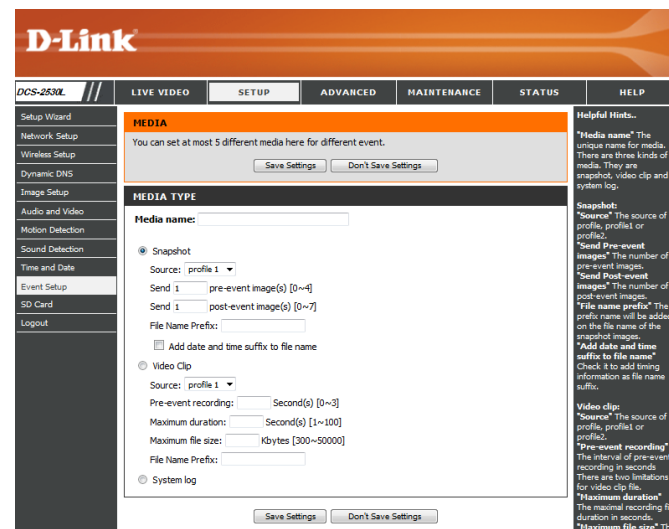
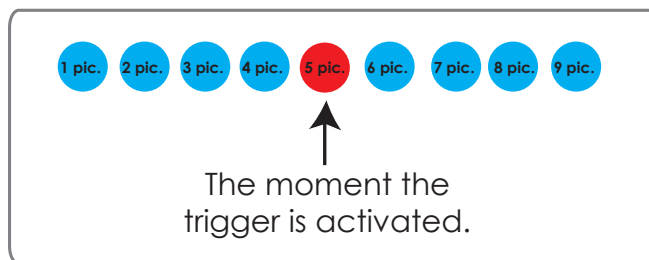

**File name prefix:** Enter the prefix to add to the saved file name.

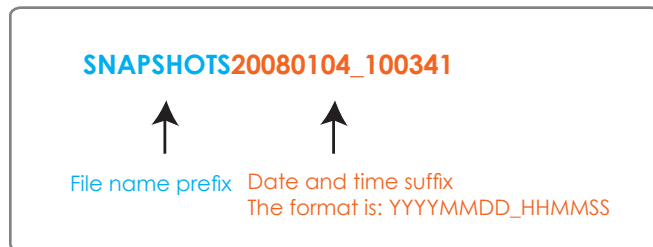

**Add date and time suffix to file name:** Check this to add the date and time the snapshot was recorded as a file name suffix.

**Video clip:** Select this option to set the media type to video clips.

**Source:** Set the video profile to use as the media source. Refer to "Audio and Video" on page 32 for more information on video profiles.

**Pre-event recording:** This sets how many seconds to record before the main event video clip starts. You can record up to 4 seconds of pre-event video.

**Maximum duration:** Set the maximum length of video to record for your video clips.

**Maximum file size:** Set the maximum file size to record for your video clips.

**File Name Prefix:** This is the prefix that will be added to the filename of saved video clips.

**System log:** Select this option to set the media type to system logs. This will send the system log, but will not record any snapshots or video.

The screenshot shows the "MEDIA TYPE" configuration window. It has a "Media name:" field at the top. Below it are three radio button options: "Snapshot" (selected), "Video Clip", and "System log". Under "Snapshot", there is a "Source:" dropdown menu set to "profile 1", two "Send" fields (both set to "1") for "pre-event image(s) [0~4]" and "post-event image(s) [0~7]", a "File Name Prefix:" field, and a checkbox for "Add date and time suffix to file name". Under "Video Clip", there is a "Source:" dropdown menu set to "profile 1", a "Pre-event recording:" field set to "1" with "Second(s) [0~3]", a "Maximum duration:" field set to "1" with "Second(s) [1~100]", a "Maximum file size:" field set to "300" with "Kbytes [300~50000]", and a "File Name Prefix:" field. At the bottom right, there are two buttons: "Save Settings" and "Don't Save Settings".

## Add Event

Create and schedule up to three events with their own settings here. After making any changes, click the **Save Settings** button to save your changes.

**Event name:** Enter a name for the event.

**Enable this event:** Select this box to activate this event.

**Priority:** Set the priority for this event. The event with higher priority will be executed first.

**Delay:** Specify the delay time before allowing this event to be triggered again. This is used for both motion detection events and digital input triggers.

**Trigger:** Specify the input type that triggers the event.

**Video Motion Detection:** Selecting this will trigger the event when motion is detected during live video monitoring. Make sure you have enabled motion detection and specified what part of the image to monitor for motion. For more details, refer to "Motion Detection" on page 33.

**Periodic:** Selecting this will trigger the event in specified intervals. The trigger interval unit is in minutes.

**System Boot:** Selecting this will trigger an event when the system boots up.

**Network Lost:** Selecting this will trigger an event when the camera's connection to the network is lost.

**Event Schedule:** Specify when you want to monitor for this event. Select which days to monitor for this event, then select **Always** or enter the time interval to monitor for the specified event.

**Action:** If you have created Server and Media entries, you will see them appear here. Select which Server you want to send to and which Media you want the camera to send.

**ACTION**

E-mail  
Attached media:

SD Card  
Attached media:

---

## Add Recording

Here you can configure and schedule a regular video recording. After making any changes, click the **Save Settings** button to save your changes.

**Recording entry name:** Enter a name for the recording.

**Enable this recording:** Select this to enable this recording.

**Priority:** Set the priority for this recording. A recording with a higher priority will be the one used if two recordings will happen at the same time.

**Source:** Select the video profile to use as the recording source.

**Recording schedule:** Use the checkboxes to set which days to record video on. Select **Always** to record for the entire day, or select **From** and specify the period of time you want to record using the drop-down menus.

**Destination:** Select the Server to save the recording file to. If you created a server entry for the microSD card slot, you can select **SD** to save to it.

**Total cycling recording size:** Specify the amount of disk space to use for this recording (between 200 MB and 2 TB). When this space is full, the oldest recordings will be deleted to make room for new recordings. For example, if each recording file is 6 MB, and the total cycling recording size is 600 MB, then the camera will record 100 files in the specified destination. After that, the oldest file will be deleted to make space for new ones.

Please note that if the amount of free disk space is not enough, the recording will stop. Before you set up this option, please make sure your storage drive has enough free space. Also, it is recommended that you do not save other files in the same folder as your recording files.

The screenshot shows the D-Link web interface for the DCS-2530L camera. The main navigation bar includes 'LIVE VIDEO', 'SETUP', 'ADVANCED', 'MAINTENANCE', 'STATUS', and 'HELP'. The 'SETUP' menu is expanded, showing options like 'Setup Wizard', 'Network Setup', 'Wireless Setup', 'Dynamic DNS', 'Image Setup', 'Audio and Video', 'Motion Detection', 'Sound Detection', 'Time and Date', 'Event Setup', 'SD Card', and 'Logout'. The 'RECORDING' configuration page is displayed, featuring a 'RECORDING' section with a text input for 'Recording entry name', an 'Enable this recording' checkbox, a 'Priority' dropdown menu (set to 'normal'), and a 'Source' dropdown menu (set to 'profile 1'). Below this is the 'RECORDING SCHEDULE' section, which includes checkboxes for each day of the week (Sun, Mon, Tue, Wed, Thu, Fri, Sat) and radio buttons for 'Always' and 'From' (with time range 00:00 to 23:59). The 'RECORDING SETTINGS' section includes a 'Destination' dropdown menu (set to 'None'), a 'Total cycling recording size' of 1000 Mbytes, a 'Size of each file for recording' of 10 Mbytes, and a 'Time of each file for recording' of 10 seconds. There are 'Save Settings' and 'Don't Save Settings' buttons at the bottom of each section. A sidebar on the right contains 'Helpful Hints...' and 'Total cycling recording size' information.

## Section 3: Configuration

---

**Size of each file for recording:** If this is selected, files will be separated based on the file size you specify.

**Time of each file for recording:** If this is selected, files will be separated based on the maximum length you specify.

**File Name Prefix:** The prefix name will be added to the file name of the recording file(s).

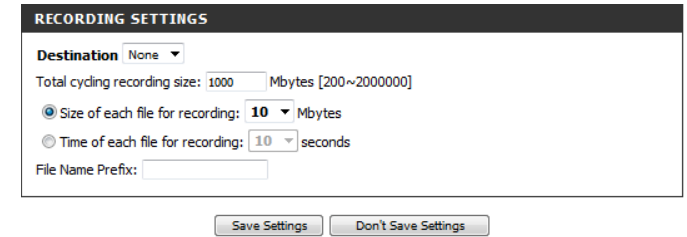

The screenshot shows a configuration window titled "RECORDING SETTINGS". It contains the following fields and options:

- Destination:** A dropdown menu currently set to "None".
- Total cycling recording size:** A text input field containing "1000" followed by "Mbytes [200~2000000]".
- Size of each file for recording:** A radio button that is selected, followed by a dropdown menu set to "10" and the text "Mbytes".
- Time of each file for recording:** A radio button that is not selected, followed by a dropdown menu set to "10" and the text "seconds".
- File Name Prefix:** An empty text input field.

At the bottom of the window, there are two buttons: "Save Settings" and "Don't Save Settings".

## SD Card

Here you may browse and manage the recorded files which are stored on the microSD card. Video is stored in the Video folder, and snapshots are stored in the Picture folder. You can playback video and view snapshots by clicking on the appropriate folder, then clicking on the file you want to view.

**Files Per Page:** Use the drop-down menu to specify how many files to show per page. To change pages, use the drop-down menu on the right.

**Refresh:** Click this to refresh the file and folder information from the microSD card.

**Format SD Card:** Click this icon to automatically format the microSD card and create the Video and Picture folders.

**Deleting Files and Folders:** To delete files and folders, click on the checkbox next to the files or folders you want to delete, then click the **OK** button.

The screenshot shows the D-Link DCS-2530L web interface. The main content area is titled "SD CARD" and contains the following information:

- SD Card: /
- Files per Page: 10 (dropdown menu)
- Refresh button
- SD Status: Ready
- 1 of 1 (dropdown menu)

Delete	File	Num of files	Size
<input type="checkbox"/>	Picture	0	
<input type="checkbox"/>	Video	0	

Below the table is a "Format SD Card" button and a status bar showing "Total:4013056KB, Used:96KB, Free:4012960KB". An "OK" button is located at the bottom right of the main content area.

The sidebar on the right contains "Helpful Hints..." with instructions on how to format the SD card, view recorded pictures, and playback recorded video.

# Advanced

## ICR and IR

Here you can configure the ICR and IR settings. The IR (Infrared) Cut-Removable (ICR) filter can be disengaged for increased sensitivity in low light environments.

**Automatic:** The Day/Night mode is set automatically. You can use the **Sensitivity** drop-down box to set when the camera will switch to Night mode. The text box to the right shows what lighting conditions are currently being detected by the camera for reference. You can refresh this status by clicking the **Refresh** button.

**Day Mode:** Day mode enables the IR Cut Filter.

**Night Mode:** Night mode disables the IR Cut Filter.

**Schedule Mode:** Set up the Day/Night mode using a schedule. The camera will enter Day mode at the starting time and return to Night mode at the ending time.

**IR Light Control:** The camera can enable or disable the IR (infrared) light according to your preferences. This setting provides additional controls depending on your specific application.

**Off:** The IR light will always be off.

**On:** The IR light will always be on.

**Sync with ICR:** The IR light will turn on when the ICR filter is disabled (night mode).

**Schedule:** The IR light will turn on or off according to the schedule that you specify below.

The screenshot displays the D-Link DCS-2530L web interface for configuring ICR and IR settings. The main content area is titled "ICR AND IR" and includes the following sections:

- ICR AND IR:** An IR(Infrared) Cut-Removable(ICR) filter can be disengaged from the image path for increased sensitivity in low light environments. The ICR filter will automatically engage depending on the ambient light, allowing the camera to be effective in Day/Night environments.
  - Select the Day/Night from the radio button. The available options are Automatic, Schedule mode, Day mode and Night mode.
  - The default value is Automatic.
- Light Sensor Sensitivity:** Light sensor sensitivity has Low, Medium, and High three different levels. You may get current camera light illumination by clicking Refresh button to set proper level of Light sensor sensitivity. For example, when level sets at High less than 30Lux, camera will switch Day & Night mode to Night mode.
- IR Light:** The built-in IR light illuminators will be activated automatically or manually so as to supplement the low light situation without additional equipment.

Buttons for "Save Settings" and "Don't Save Settings" are present at the bottom of the ICR AND IR section.

The **ICR** section includes:
 

- Removable IR-Cut filter trigger condition:
  - Automatic: Sensitivity: Medium <20Lux (over 30 lux) Refresh
  - Day mode
  - Night mode
  - Schedule mode: Day mode(24hr) From 00 To 23 59

The **IR LIGHT** section includes:
 

- IR Light Control: Medium (dropdown)
- Off
- On
- Sync. With ICR
- Schedule
- IR Light Control On(24hr): From 00 To 23 59

 Buttons for "Save Settings" and "Don't Save Settings" are present at the bottom of the IR LIGHT section.

The right sidebar contains **Helpful Hints:**

- ICR and IR:** Automatic: The Day/Night mode is set automatically. It is normally set in the Day mode and changes to the Night mode in a dark place. Day mode: The Day mode means disable the IR Cut Filter. Night mode: The Night mode means enable the IR Cut Filter.
- Schedule mode:** Set the Day/Night mode using the schedule. Fill in the time so the Day/Night mode is normally set to Day mode at the start time and returns to the Night mode at the end time.
- IR Light Control:** In poor light conditions, open IR Light Control to automatically turn on the light to enable you to take clear pictures. The IR Light Control has 4 options: Off, On, Sync. with ICR, and Schedule. Off: This option disable the IR Light Control. On: This option automatically opens the IR Light Control to enable a camera to take clear images in poor light conditions. Sync. with ICR: In this option, the IR Light Control will open automatically and follow the ICR settings. Schedule: In this option, you have to customize the setting to set the time period you want. Please set the Start time and the End time of your chosen schedule.

# HTTPS

This page allows you to install and activate an HTTPS certificate for secure access to your camera. After making any changes, click the **Save Settings** button to save your changes.

**Enable HTTPS** Enable HTTPS connections. You will need to create a certificate using **Secure Connection:** the settings below.

**Create Certificate Method:** Choose the way the certificate should be created. Three options are available:

- Create a self-signed certificate automatically
- Create a self-signed certificate manually
- Create a certificate request and install

**Status:** Displays the status of the certificate.

**Note:** The certificate cannot be removed while HTTPS is still enabled. To remove the certificate, you must first uncheck **Enable HTTPS secure connection**.



## Access List

Here you can set access permissions for users to view your DCS-2530L.

**Allow list:** The list of IP addresses that have access rights to the camera.

**Note:** When adding entries to the Allow list, make sure the first entry includes the IP address of the computer or device you are using to access the camera. Otherwise, you may be blocked from accessing the camera after adding the entry to the Allow list.

**Start IP address:** The starting IP address of the IP address range for the devices (such as a computer) that have permission to access the video of the camera.

**End IP address:** The ending IP address of the IP address range for the devices (such as a computer) that have permission to access the video of the camera. Click **Add** to save your changes.

**Note:** You can create seven entries for both the Allow list and the Deny list.

**Delete allow list:** Select an entry to remove from the Allow List, then click **Delete**.

**Deny list:** The list of IP addresses that have no access rights to the camera.

**Delete deny list:** Select an entry to remove from the Deny List, then click **Delete**.

**Note:** All addresses in the Deny List will be denied access, even if they are also in the Allow List.

The screenshot shows the D-Link web interface for the DCS-2530L camera. The top navigation bar includes 'LIVE VIDEO', 'SETUP', 'ADVANCED', 'MAINTENANCE', 'STATUS', and 'HELP'. The 'ACCESS LIST' page is displayed, featuring a sidebar with 'Access List' selected. The main content area is divided into 'ALLOW LIST' and 'DENY LIST' sections. Each section has input fields for 'Start IP address', 'End IP address', and 'Delete' buttons. The 'ALLOW LIST' section also includes a 'Delete allow list' dropdown menu. The 'DENY LIST' section also includes a 'Delete deny list' dropdown menu. On the right side, there is a 'Helpful Hints...' section with detailed instructions for each field and button.

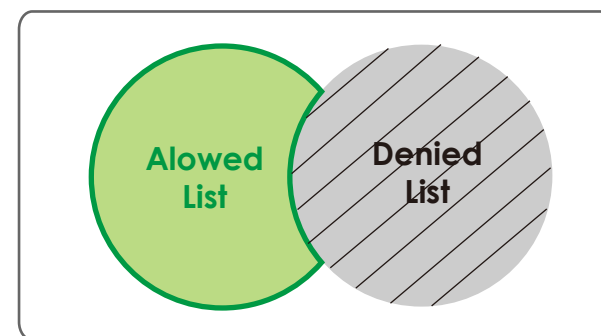

# Maintenance Admin

You may modify the name and administrator's password of your camera, as well as add and manage the user accounts for accessing the camera. You may also use this section to create a unique name and configure the OSD settings for your camera.

**Admin Password Setting:** Set a new password for the administrator's account.

**Add User Account:** Add a new user account.

**User Name:** Enter the user name for the new account.

**New Password:** Enter the password for the new account.

**User List:** All the existing user accounts will be displayed here. You may delete accounts included in the list, but you may want to reserve at least one as a guest account.

**IP Camera Name:** Create a unique name for your camera that will be added to the file name prefix when creating a snapshot or a video clip.

**Enable OSD:** Select this option to enable the On-Screen Display feature for your camera, which shows the camera name, date, and time on the camera's video.

**Label:** Enter a label for the camera, which will be shown on the OSD when it is enabled.

**LED:** You may specify whether or not to illuminate the status LED on the camera.

The screenshot displays the D-Link maintenance admin interface for the DCS-2530L camera. The main content area is titled 'ADMIN' and contains several sections:

- ADMIN:** A introductory message stating that users can change the administrator's password, add/delete user accounts, and enable the OSD (On-Screen Display) feature.
- ADMIN PASSWORD SETTING:** Fields for 'New Password' (63 characters maximum) and 'Retype Password' (63 characters maximum) with a 'Save' button.
- ADD USER ACCOUNT:** Fields for 'User Name' (5 users maximum), 'New Password' (63 characters maximum), and 'Retype Password' (63 characters maximum) with an 'Add' button.
- USER LIST:** A table with a 'User Name' column and a 'Delete' button.
- DEVICE SETTING:** Fields for 'IP Camera Name' (DCS-2530L, 63 characters maximum) and 'Label' (DCS-2530L, 63 characters maximum) with a 'Save' button. There is also a checked 'Enable OSD' checkbox.
- LED:** Radio buttons for 'On' and 'Off' with a 'Save' button.

On the right side, there are helpful hints: 'Enabling OSD: the IP camera name and time will be displayed on the video screen for the user.' and 'For security purposes, it is recommended that you change the password for your administrator account. Be sure to write down the new password to avoid having to reset the IP camera in the event that it is forgotten.' A note about the LED states: 'LED: In the near panel of your camera there is a LED beside the network adapter. ON: The LED will flash a light to indicate if the network is working or not. OFF: No light will show forth option is turn off.'

## System

In this section, you may backup, restore and reset the camera configuration, or reboot the camera.

**Save To Local Hard Drive:** You may save your current camera configuration as a file on your computer.

**Load From Local Hard Drive:** Locate a pre-saved configuration by clicking **Browse** and then restore the pre-defined settings to your camera by clicking **Load Configuration**.

**Restore to Factory Defaults:** You may reset your camera and restore the factory settings by clicking **Restore Factory Defaults**.

**Reboot Device:** This will restart your camera.

**Enable Schedule Reboot:** If you want your camera to reboot on a regular schedule, check the **Enable Schedule Reboot** checkbox, then select the days and time you want the camera to reboot on.



## Firmware Upgrade

The camera's current firmware version will be displayed on this screen. You may visit the D-Link Support Website to check for the latest available firmware version.

To upgrade the firmware on your DCS-2530L, please download and save the latest firmware version from the D-Link Support Page to your local hard drive. Locate the file on your local hard drive by clicking the **Browse** button. Select the file and click the **Upload** button to start upgrading the firmware.

**Current Firmware Version:** Displays the detected firmware version.

**Current Product Name:** Displays the camera model name.

**File Path:** Locate the file (upgraded firmware) on your hard drive by clicking **Browse**.

**Upload:** Uploads the new firmware to your camera.

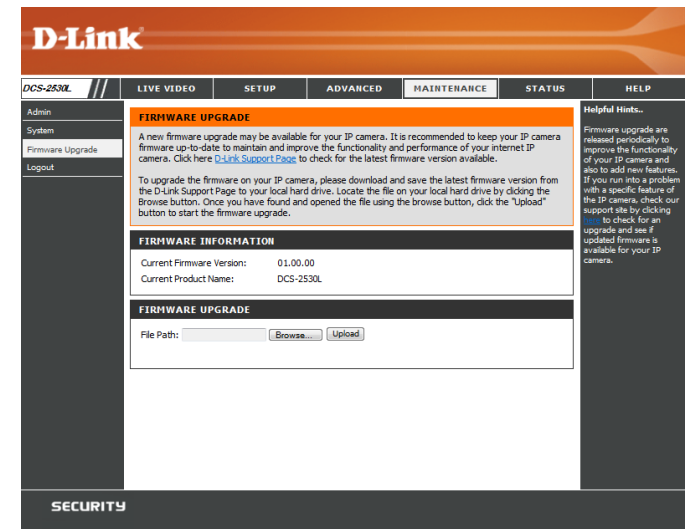

# Status

## Device Info

This page displays detailed information about your device and network connection.

The screenshot shows the D-Link web interface for a DCS-2530L camera. The top navigation bar includes links for LIVE VIDEO, SETUP, ADVANCED, MAINTENANCE, STATUS (selected), and HELP. The left sidebar contains links for Device Info (selected), Log, and Logout. The main content area is titled 'DEVICE INFO' and contains a message: 'All of your network connection details are displayed on this page. The firmware version is also displayed here.' Below this is an 'INFORMATION' table with the following data:

INFORMATION	
IP Camera Name	DCS-2530L
Time & Date	Fri Jan 29 16:11:39 2016
Firmware Version	01.00.00
Hardware Version	A
MAC Address	B0:C5:54:17:D5:EB
IP Address	192.168.0.164
IP Subnet Mask	255.255.255.0
Default Gateway	192.168.0.1
Primary DNS	192.168.0.1
Secondary DNS	0.0.0.0
PPPoE	Disable
DDNS	Disable
Agent Version	2.0.20-b23

On the right side, there is a 'Helpful Hints..' section with the text: 'This page displays all the information about the IP camera and network settings.'

# Log

This page displays the log information of your camera. You may download the information by clicking **Download**. You may also click **Clear** to delete the saved log information.

**D-Link**

DCS-2530L // LIVE VIDEO SETUP ADVANCED MAINTENANCE STATUS HELP

Device Info  
Log  
Logout

**SYSTEM LOG**  
The system log records IP camera events that have occurred.

**Helpful Hints..**  
You can save the log to your local hard IP camera by clicking the Download button, and you can clear the log by clicking on the Clear button.

**CURRENT LOG**

1. 2016/01/29 15:49:14 network set to DHCP
2. 2016/01/29 15:49:08 network set to static IP 10.255.255.1
3. 2016/01/29 15:49:02 system power on.
4. 2016/01/29 15:48:48 system reset to factory settings.
5. 2016/01/29 15:27:50 Event recover - netloss detection.
6. 2016/01/29 15:27:49 Event trigger - netloss detection.
7. 2016/01/29 15:27:48 network set to DHCP
8. 2016/01/29 15:27:44 network set to static IP 20.0.0.1
9. 2016/01/29 15:27:39 Event recover - netloss detection.
10. 2016/01/29 15:27:38 Event trigger - netloss detection.
11. 2016/01/29 15:27:29 system power on.
12. 2016/01/29 14:58:32 Event recover - netloss detection.
13. 2016/01/29 14:58:31 network set to static IP 20.0.0.1
14. 2016/01/29 14:58:26 Event trigger - netloss detection.
15. 2016/01/29 14:54:48 Event recover - netloss detection.
16. 2016/01/29 14:54:47 Event trigger - netloss detection.
17. 2016/01/29 14:54:47 network set to DHCP
18. 2016/01/29 14:54:40 Event recover - netloss detection.
19. 2016/01/29 14:54:39 network set to static IP 20.0.0.1
20. 2016/01/29 14:54:38 Event trigger - netloss detection.

First Page Previous 20 Next 20  
Clear Download

**SECURITY**

# Help

This page provides helpful information regarding camera operation.

The screenshot shows the D-Link DCS-2530L web interface. At the top is the D-Link logo. Below it is a navigation bar with tabs for LIVE VIDEO, SETUP, ADVANCED, MAINTENANCE, STATUS, and HELP. The HELP tab is selected. On the left side, there is a sidebar with 'Help' and 'Logout' links. The main content area is titled 'HELP' and contains a list of links for each menu item: LIVE VIDEO (Camera), SETUP (Setup Wizard, Network Setup, Wireless Setup, Dynamic DNS, Image Setup, Audio and Video, Motion Detection, Sound Detection, Time and Date, Event Setup, SD Card), ADVANCED (ICR and IR, HTTPS, Access List), MAINTENANCE (Admin, System, Firmware Upgrade), and STATUS (Device Info, Log). At the bottom of the page, there is a 'SECURITY' section.

**D-Link**

DCS-2530L // LIVE VIDEO SETUP ADVANCED MAINTENANCE STATUS HELP

Help  
Logout

**HELP**

- LIVE VIDEO
- SETUP
- MAINTENANCE
- ADVANCED
- STATUS

**LIVE VIDEO**

- [Camera](#)

**SETUP**

- [Setup Wizard](#)
- [Network Setup](#)
- [Wireless Setup](#)
- [Dynamic DNS](#)
- [Image Setup](#)
- [Audio and Video](#)
- [Motion Detection](#)
- [Sound Detection](#)
- [Time and Date](#)
- [Event Setup](#)
- [SD Card](#)

**ADVANCED**

- [ICR and IR](#)
- [HTTPS](#)
- [Access List](#)

**MAINTENANCE**

- [Admin](#)
- [System](#)
- [Firmware Upgrade](#)

**STATUS**

- [Device Info](#)
- [Log](#)

**SECURITY**

# Technical Specifications

Camera		
Camera Hardware Profile	<ul style="list-style-type: none"> <li>• 1/3" Megapixel progressive CMOS sensor</li> <li>• Minimum illumination:               <ul style="list-style-type: none"> <li>• Color mode: 0.5 lux</li> <li>• B/W mode (LEDs off): 0.1 lux</li> <li>• B/W mode (LEDs on): 0 lux</li> </ul> </li> <li>• Minimum object distance 30 cm</li> <li>• Lens focal length: 1.7 mm</li> </ul>	<ul style="list-style-type: none"> <li>• Aperture: F2.5</li> <li>• Angle of view (16:9):               <ul style="list-style-type: none"> <li>• (H) 180°</li> <li>• (V) 86°</li> <li>• (D) 180°</li> </ul> </li> <li>• Stand angle: -15° to 90°</li> </ul>
Image Features	<ul style="list-style-type: none"> <li>• Configurable image size, quality, frame rate, and bit rate</li> <li>• Wide Dynamic Range (WDR)</li> <li>• 3D filtering</li> <li>• Time stamp and text overlays</li> </ul>	<ul style="list-style-type: none"> <li>• Configurable motion detection windows</li> <li>• Configurable privacy mask zones</li> <li>• Configurable exposure time, brightness, saturation, contrast, sharpness.</li> </ul>
Video Compression	<ul style="list-style-type: none"> <li>• Simultaneous H.264/MJPEG format compression</li> <li>• H.264 multicast streaming</li> </ul>	<ul style="list-style-type: none"> <li>• JPEG for still images</li> </ul>
Video Resolution	<ul style="list-style-type: none"> <li>• 16:9</li> <li>• 1920 x 1080 at up to 15 fps</li> <li>• 1280 x 720, 800 x 448, 640 x 360 at up to 30 fps</li> </ul>	
Audio Support	<ul style="list-style-type: none"> <li>• G.711 128 Kbps</li> </ul>	<ul style="list-style-type: none"> <li>• AAC 32 Kbps</li> </ul>
Connectivity	<ul style="list-style-type: none"> <li>• 802.11n/g/b wireless with WPA/WPA2 encryption</li> <li>• Operates on 2.4 GHz band</li> </ul>	<ul style="list-style-type: none"> <li>• Maximum data rate of 300 MBps (PHY rate)<sup>1</sup></li> <li>• microSD/SDHC/SDXC card Slot, accepts cards up to 128 GB</li> </ul>
Network		
Network Protocols	<ul style="list-style-type: none"> <li>• IPv6, IPv4, ARP, TCP, UDP, ICMP</li> <li>• DHCP client</li> <li>• NTP client (D-Link)</li> <li>• DNS client</li> <li>• DDNS client (D-Link)</li> <li>• SMTP client</li> </ul>	<ul style="list-style-type: none"> <li>• HTTP server</li> <li>• UPnP port forwarding</li> <li>• RTP/RTSP/RTCP</li> <li>• HTTPS (for configuration)</li> <li>• ONVIF</li> <li>• Bonjour</li> </ul>
Security	<ul style="list-style-type: none"> <li>• Administrator and user group protection</li> <li>• Password authentication</li> </ul>	<ul style="list-style-type: none"> <li>• HTTP and RTSP digest encryption</li> </ul>
System Integration		
System Requirements for Web Interface	<ul style="list-style-type: none"> <li>• Operating System: Windows 10/8/7 or Mac OS X 10.7 or higher</li> </ul>	<ul style="list-style-type: none"> <li>• Browser: Internet Explorer 8, Firefox 12, Chrome 20<sup>2</sup>, or Safari 6 or higher</li> </ul>
Event Management	<ul style="list-style-type: none"> <li>• Motion detection</li> <li>• Sound level detection</li> </ul>	<ul style="list-style-type: none"> <li>• Event notification and uploading of snapshots/video clips via e-mail</li> <li>• Scheduled recording</li> </ul>

## Appendix A: Technical Specifications

Remote Management	• Configuration interface accessible via web browser	
Mobile Support	• mydlink Lite app for iPhone, iPad, iPod Touch, Android, and Windows	• mydlink+ app for iPad and Android
General		
Dimensions	• 109.6 x 66.0 x 66.0 mm (4.3 x 2.4 x 2.4 inches) ± 5%	
Weight	• 105 grams (3.7 ounces) ± 5%	
Power Adapter	• Input: 100 to 240 V AC, 50/60 Hz	• Output: 5 V DC 1.2 A
Power Consumption	• 4.5 watts ± 5%	
Temperature	• Operating: 0 to 40 °C (32 to 104 °F)	• Storage: -20 to 70 °C (-4 to 158 °F)
Humidity	• Operating: 20% to 80% non-condensing	• Storage: 5% to 95% non-condensing
Certifications	• CE • CE LVD	• FCC • ICES
Dimensions Diagram	<p>The diagram illustrates the physical dimensions of the D-Link DCS-2530L camera. It features two views: a front view and a side view. In the front view, the total height of the camera is 109.6 mm, and the height of the lens assembly is 60.7 mm. The side view shows a lens width of 34.4 mm and a base diameter of 66 mm. The D-Link logo is visible on the front view.</p>	

<sup>1</sup> Maximum wireless signal rate derived from IEEE standard 802.11n specifications. Actual data throughput will vary. Network conditions and environmental factors, including volume of network traffic, building materials and construction, and network overhead, lower actual data throughput rate. Environmental factors will adversely affect wireless signal range.

<sup>2</sup> Chrome for configuration only.

# Contacting Technical Support

U.S. and Canadian customers can contact D-Link technical support through our web site or by phone.

Before you contact technical support, please have the following ready:

- Model number of the product (e.g. DCS-2530L)
- Hardware Revision (located on the label on the bottom of the camera (e.g. rev A1))
- Serial Number (s/n number located on the label on the bottom of the camera).

You can find software updates and user documentation on the D-Link website as well as frequently asked questions and answers to technical issues.

## For customers within the United States:

### Phone Support:

(877) 453-5465

### Internet Support:

<http://support.dlink.com>

## For customers within Canada:

### Phone Support:

(800) 361-5265

### Internet Support:

<http://support.dlink.ca>

# Warranty

Subject to the terms and conditions set forth herein, D-Link Systems, Inc. (“D-Link”) provides this Limited Warranty:

- Only to the person or entity that originally purchased the product from D-Link or its authorized reseller or distributor, and
- Only for products purchased and delivered within the fifty states of the United States, the District of Columbia, U.S. Possessions or Protectorates, U.S. Military Installations, or addresses with an APO or FPO.

## Limited Warranty:

D-Link warrants that the hardware portion of the D-Link product described below (“Hardware”) will be free from material defects in workmanship and materials under normal use from the date of original retail purchase of the product, for the period set forth below (“Warranty Period”), except as otherwise stated herein.

- Hardware (excluding power supplies and fans): One (1) year
- Power supplies and fans: One (1) year
- Spare parts and spare kits: Ninety (90) days

The customer’s sole and exclusive remedy and the entire liability of D-Link and its suppliers under this Limited Warranty will be, at D-Link’s option, to repair or replace the defective Hardware during the Warranty Period at no charge to the original owner or to refund the actual purchase price paid. Any repair or replacement will be rendered by D-Link at an Authorized D-Link Service Office. The replacement hardware need not be new or have an identical make, model or part. D-Link may, at its option, replace the defective Hardware or any part thereof with any reconditioned product that D-Link reasonably determines is substantially equivalent (or superior) in all material respects to the defective Hardware. Repaired or replacement hardware will be warranted for the remainder of the original Warranty Period or ninety (90) days, whichever is longer, and is subject to the same limitations and exclusions. If a material defect is incapable of correction, or if D-Link determines that it is not practical to repair or replace the defective Hardware, the actual price paid by the original purchaser for the defective Hardware will be refunded by D-Link upon return to D-Link of the defective Hardware. All Hardware or part thereof that is replaced by D-Link, or for which the purchase price is refunded, shall become the property of D-Link upon replacement or refund.

### **Limited Software Warranty:**

D-Link warrants that the software portion of the product (“Software”) will substantially conform to D-Link’s then current functional specifications for the Software, as set forth in the applicable documentation, from the date of original retail purchase of the Software for a period of ninety (90) days (“Software Warranty Period”), provided that the Software is properly installed on approved hardware and operated as contemplated in its documentation. D-Link further warrants that, during the Software Warranty Period, the magnetic media on which D-Link delivers the Software will be free of physical defects. The customer’s sole and exclusive remedy and the entire liability of D-Link and its suppliers under this Limited Warranty will be, at D-Link’s option, to replace the non-conforming Software (or defective media) with software that substantially conforms to D-Link’s functional specifications for the Software or to refund the portion of the actual purchase price paid that is attributable to the Software. Except as otherwise agreed by D-Link in writing, the replacement Software is provided only to the original licensee, and is subject to the terms and conditions of the license granted by D-Link for the Software. Replacement Software will be warranted for the remainder of the original Warranty Period and is subject to the same limitations and exclusions. If a material non-conformance is incapable of correction, or if D-Link determines in its sole discretion that it is not practical to replace the non-conforming Software, the price paid by the original licensee for the non-conforming Software will be refunded by D-Link; provided that the non-conforming Software (and all copies thereof) is first returned to D-Link. The license granted respecting any Software for which a refund is given automatically terminates.

### **Non-Applicability of Warranty:**

The Limited Warranty provided hereunder for Hardware and Software portions of D-Link’s products will not be applied to and does not cover any refurbished product and any product purchased through the inventory clearance or liquidation sale or other sales in which D-Link, the sellers, or the liquidators expressly disclaim their warranty obligation pertaining to the product and in that case, the product is being sold “As-Is” without any warranty whatsoever including, without limitation, the Limited Warranty as described herein, notwithstanding anything stated herein to the contrary.

### **Submitting A Claim (USA):**

The customer shall return the product to the original purchase point based on its return policy. In case the return policy period has expired and the product is within warranty, the customer shall submit a claim to D-Link as outlined below:

- The customer must submit with the product as part of the claim a written description of the Hardware defect or Software nonconformance in sufficient detail to allow D-Link to confirm the same, along with proof of purchase of the product (such as a copy of the dated purchase invoice for the product) if the product is not registered.
- The customer must obtain a Case ID Number from D-Link Technical Support at 1-877-354-6555, who will attempt to assist the customer in resolving any suspected defects with the product. If the product is considered defective, the customer must obtain a Return Material Authorization (“RMA”) number by completing the RMA form and entering the assigned Case ID Number at <https://rma.dlink.com/>.

- After an RMA number is issued, the defective product must be packaged securely in the original or other suitable shipping package to ensure that it will not be damaged in transit, and the RMA number must be prominently marked on the outside of the package. Do not include any manuals or accessories in the shipping package. D-Link will only replace the defective portion of the product and will not ship back any accessories.
- The customer is responsible for all in-bound shipping charges to D-Link. No Cash on Delivery (“COD”) is allowed. Products sent COD will either be rejected by D-Link or become the property of D-Link. Products shall be fully insured by the customer and shipped to D-Link Systems, Inc., 17595 Mt. Herrmann, Fountain Valley, CA 92708. D-Link will not be held responsible for any packages that are lost in transit to D-Link. The repaired or replaced packages will be shipped to the customer via UPS Ground or any common carrier selected by D-Link. Return shipping charges shall be prepaid by D-Link if you use an address in the United States, otherwise we will ship the product to you freight collect. Expedited shipping is available upon request and provided shipping charges are prepaid by the customer. D-Link may reject or return any product that is not packaged and shipped in strict compliance with the foregoing requirements, or for which an RMA number is not visible from the outside of the package. The product owner agrees to pay D-Link’s reasonable handling and return shipping charges for any product that is not packaged and shipped in accordance with the foregoing requirements, or that is determined by D-Link not to be defective or non-conforming.

### **What Is Not Covered:**

The Limited Warranty provided herein by D-Link does not cover:

Products that, in D-Link’s judgment, have been subjected to abuse, accident, alteration, modification, tampering, negligence, misuse, faulty installation, lack of reasonable care, repair or service in any way that is not contemplated in the documentation for the product, or if the model or serial number has been altered, tampered with, defaced or removed; Initial installation, installation and removal of the product for repair, and shipping costs; Operational adjustments covered in the operating manual for the product, and normal maintenance; Damage that occurs in shipment, due to act of God, failures due to power surge, and cosmetic damage; Any hardware, software, firmware or other products or services provided by anyone other than D-Link; and Products that have been purchased from inventory clearance or liquidation sales or other sales in which D-Link, the sellers, or the liquidators expressly disclaim their warranty obligation pertaining to the product.

While necessary maintenance or repairs on your Product can be performed by any company, we recommend that you use only an Authorized D-Link Service Office. Improper or incorrectly performed maintenance or repair voids this Limited Warranty.

### **Disclaimer of Other Warranties:**

EXCEPT FOR THE LIMITED WARRANTY SPECIFIED HEREIN, THE PRODUCT IS PROVIDED “AS-IS” WITHOUT ANY WARRANTY OF ANY KIND WHATSOEVER INCLUDING, WITHOUT LIMITATION, ANY WARRANTY OF MERCHANTABILITY, FITNESS FOR A PARTICULAR PURPOSE AND NONINFRINGEMENT.

IF ANY IMPLIED WARRANTY CANNOT BE DISCLAIMED IN ANY TERRITORY WHERE A PRODUCT IS SOLD, THE DURATION OF SUCH IMPLIED WARRANTY SHALL BE LIMITED TO THE DURATION OF THE APPLICABLE WARRANTY PERIOD SET FORTH ABOVE. EXCEPT AS EXPRESSLY COVERED UNDER THE LIMITED WARRANTY PROVIDED HEREIN, THE ENTIRE RISK AS TO THE QUALITY, SELECTION AND PERFORMANCE OF THE PRODUCT IS WITH THE PURCHASER OF THE PRODUCT.

### **Limitation of Liability:**

TO THE MAXIMUM EXTENT PERMITTED BY LAW, D-LINK IS NOT LIABLE UNDER ANY CONTRACT, NEGLIGENCE, STRICT LIABILITY OR OTHER LEGAL OR EQUITABLE THEORY FOR ANY LOSS OF USE OF THE PRODUCT, INCONVENIENCE OR DAMAGES OF ANY CHARACTER, WHETHER DIRECT, SPECIAL, INCIDENTAL OR CONSEQUENTIAL (INCLUDING, BUT NOT LIMITED TO, DAMAGES FOR LOSS OF GOODWILL, LOSS OF REVENUE OR PROFIT, WORK STOPPAGE, COMPUTER FAILURE OR MALFUNCTION, FAILURE OF OTHER EQUIPMENT OR COMPUTER PROGRAMS TO WHICH D-LINK'S PRODUCT IS CONNECTED WITH, LOSS OF INFORMATION OR DATA CONTAINED IN, STORED ON, OR INTEGRATED WITH ANY PRODUCT RETURNED TO D-LINK FOR WARRANTY SERVICE) RESULTING FROM THE USE OF THE PRODUCT, RELATING TO WARRANTY SERVICE, OR ARISING OUT OF ANY BREACH OF THIS LIMITED WARRANTY, EVEN IF D-LINK HAS BEEN ADVISED OF THE POSSIBILITY OF SUCH DAMAGES. THE SOLE REMEDY FOR A BREACH OF THE FOREGOING LIMITED WARRANTY IS REPAIR, REPLACEMENT OR REFUND OF THE DEFECTIVE OR NONCONFORMING PRODUCT. THE MAXIMUM LIABILITY OF D-LINK UNDER THIS WARRANTY IS LIMITED TO THE PURCHASE PRICE OF THE PRODUCT COVERED BY THE WARRANTY. THE FOREGOING EXPRESS WRITTEN WARRANTIES AND REMEDIES ARE EXCLUSIVE AND ARE IN LIEU OF ANY OTHER WARRANTIES OR REMEDIES, EXPRESS, IMPLIED OR STATUTORY.

### **Governing Law:**

This Limited Warranty shall be governed by the laws of the State of California. Some states do not allow exclusion or limitation of incidental or consequential damages, or limitations on how long an implied warranty lasts, so the foregoing limitations and exclusions may not apply. This Limited Warranty provides specific legal rights and you may also have other rights which vary from state to state.

### **Trademarks:**

D-Link is a registered trademark of D-Link Corporation/D-Link Systems, Inc. Other trademarks or registered trademarks are the property of their respective owners.

### **Copyright Statement:**

No part of this publication or documentation accompanying this product may be reproduced in any form or by any means or used to make any derivative such as translation, transformation, or adaptation without permission from D-Link Corporation/D-Link Systems, Inc., as stipulated by the United States Copyright Act of 1976 and any amendments thereto. Contents are subject to change without prior notice.

Copyright ©2016 by D-Link Corporation/D-Link Systems, Inc. All rights reserved.

### **FCC Statement:**

This equipment has been tested and found to comply with the limits for a Class B digital device, pursuant to part 15 of the FCC Rules. These limits are designed to provide reasonable protection against harmful interference in a residential installation. This equipment generates, uses, and can radiate radio frequency energy and, if not installed and used in accordance with the instructions, may cause harmful interference to radio communication. However, there is no guarantee that interference will not occur in a particular installation. If this equipment does cause harmful interference to radio or television reception, which can be determined by turning the equipment off and on, the user is encouraged to try to correct the interference by one or more of the following measures:

- Reorient or relocate the receiving antenna.
- Increase the separation between the equipment and receiver.
- Connect the equipment into an outlet on a circuit different from that to which the receiver is connected.
- Consult the dealer or an experienced radio/TV technician for help.

### **FCC Caution:**

Any changes or modifications not expressly approved by the party responsible for compliance could void the user's authority to operate this equipment.

This device complies with Part 15 of the FCC Rules. Operation is subject to the following two conditions:

- (1) This device may not cause harmful interference, and
- (2) this device must accept any interference received, including interference that may cause undesired operation.

If this device is going to be operated in 5.15 ~ 5.25GHz frequency range, then it is restricted in indoor environment only.

### **IMPORTANT NOTICE:**

#### **FCC Radiation Exposure Statement:**

This equipment complies with FCC radiation exposure limits set forth for an uncontrolled environment. This equipment should be installed and operated with minimum distance 20cm between the radiator & your body. This transmitter must not be co-located or operating in conjunction with any other antenna or transmitter.

The availability of some specific channels and/or operational frequency bands are country dependent and are firmware programmed at the factory to match the intended destination. The firmware setting is not accessible by the end user.

For detailed warranty information applicable to products purchased outside the United States, please contact the corresponding local D-Link office.

# Registration

Register your product online at [registration.dlink.com](http://registration.dlink.com)



Product registration is entirely voluntary and failure to complete or return this form will not diminish your warranty rights.

Version 1.02 (US)  
November 8, 2016