

INSIGNIA™

6 Qt. Multi-Function Pressure Cooker

NS-MC60SS9



Before using your new product, please read these instructions to prevent any damage.

Contents

| | |
|--|----|
| Introduction | 2 |
| IMPORTANT SAFEGUARDS | 3 |
| Features | 5 |
| Package contents | 5 |
| Components | 6 |
| Control and display panel | 7 |
| Accessories | 8 |
| Alert sounds, display messages, and lights | 9 |
| Protection features | 10 |
| Setting up your cooker | 10 |
| Before using your cooker | 10 |
| Tips and hints for using your cooker | 11 |
| Assembling your cooker | 11 |
| Positioning your cooker | 13 |
| Using your cooker | 14 |
| Closing the lid | 14 |
| Opening the lid | 15 |
| Filling with food | 16 |
| Selecting a cooking program and cook time | 18 |
| Setting the delay timer | 19 |
| Cooking | 19 |
| Using the quick release method to open the lid | 20 |
| Steaming vegetables or fish | 21 |
| Searing or sautéing food | 22 |
| Making a cake | 23 |
| Cleaning your cooker | 24 |
| Storing your cooker | 24 |
| Troubleshooting | 25 |
| Specifications | 27 |
| ONE-YEAR LIMITED WARRANTY | 28 |

Introduction

Congratulations on your purchase of a high-quality Insignia product. Your NS-MC60SS9 represents the state of the art in multi-function pressure cooker design and is designed for reliable and trouble-free performance.

IMPORTANT SAFEGUARDS

When using your multi-function pressure cooker, always follow basic precautions, including the following:

READ ALL INSTRUCTIONS BEFORE USING

- 1 Do not touch hot surfaces—use the handles.
- 2 To avoid the risk of electric shock, do not immerse your cooker or cord in water or other liquids.
- 3 Keep your cooker away from children to avoid accidents. Close supervision is necessary when any appliance is used by or near children.
- 4 Unplug from the wall outlet when not in use or before cleaning. Let it cool before installing or removing parts and before cleaning.
- 5 Do not operate your cooker with a damaged cord or if your cooker has been dropped or damaged. To avoid the risk of electric shock, do not disassemble your cooker. Take it to a qualified serviceman for examination and repair. Incorrect assembly might result in a risk of electric shock when your cooker is used after reassembly.
- 6 Use of accessories not recommended by the manufacturer can cause injuries.
- 7 Do not use outdoors or in a damp area.
- 8 Do not let the cord hang over the edge of a table or counter, or touch hot surfaces.
- 9 Do not place on or near a gas or electric burner or an oven. Never put your whole cooker in a dishwasher (only the inner cooking pot is dishwasher safe).
- 10 Use extreme caution when moving your cooker if it contains hot oil or other hot liquids.
- 11 To disconnect, turn off, then remove the plug from the wall outlet.
- 12 Only use your cooker for its intended purpose.
- 13 Your cooker is for household use only.
- 14 **WARNING:** To reduce the risk of electric shock, cook only in the included inner cooking pot.
- 15 Do not place your cooker on an unstable surface or on a surface that might block the vent hole on the bottom, such as newspapers or foam.
- 16 Do not use your cooker in a location near water or fire, or in a place exposed to direct sunlight or splashing oil.
- 17 **WARNING:** Spilled food can cause serious burns. Keep your cooker and cord away from children. Never drape the cord over the edge of the counter, never use a power outlet below the counter, and never use with an extension cord.
- 18 Store your cooker in a place out of reach of children.
- 19 Do not use your cooker near appliances that generate magnetic fields.
- 20 Prior to each use, make sure that you check the anti-block shield, floating valve, and pressure release valve for obstructions. Wipe the surface of the inner cooking pot and the heating plate to confirm that they are free of any foreign objects.

- 21 Do not use an extension cord with your cooker. The short power cord should be used to reduce the risk resulting from the cord being grabbed by children, of becoming entangled in, or tripping on a longer cord.
- 22 Make sure that you use the appropriate amount of liquid when cooking.
- 23 Do not fill your cooker over the maximum fill line at 2/3 full. When cooking foods that expand during cooking, such as rice or dried vegetables, do not fill your cooker beyond the recommended level at 1/2 full. Over filling can clog the vent pipe and develop excess pressure. Please refer to "Filling with food" on page 16.
- 24 Do not move your cooker or forcefully remove the cover when your cooker is in operation.
- 25 Do not put your hands or face over the pressure release valve or float valve when your cooker is in operation to avoid a serious burn.
- 26 After cooking, use extreme caution when removing the cover. Serious burns can result from the steam inside your cooker.
- 27 When opening the cover after cooking, do not touch the inner cooking pot or cover with your hands to avoid burns.
- 28 Do not cover the pressure release valve.
- 29 Never deep fry or pressure fry in your cooker. It is dangerous and can cause a fire or serious damage.
- 30 Your cooker cooks under pressure. Incorrect use can result in scalding injuries. Make sure that your cooker is correctly closed before operating. Please refer to "Closing the lid" on page 14.
- 31 DO NOT OPEN YOUR COOKER UNTIL IT HAS COOLED AND ALL INTERNAL PRESSURE HAS BEEN RELEASED. If the lid is difficult to open, that indicates that your cooker is still pressurized. Do not force it open. Any pressure in your cooker can be hazardous. Please refer to "Opening the lid" on page 15.
- 32 Make sure that the handles are assembled and fastened correctly before each use. Cracked or damaged handles should be replaced.
- 33 Your cooker is not intended for use by persons (including children) with reduced physical, sensory, or mental capabilities, or lack of experience and knowledge, unless they have been supervised by a person responsible for their safety.
- 34 Never use metal utensils with your cooker. Use plastic or wooden utensils to protect the inner cooking pot from scratches.
- 35 Intended for countertop use only.
- 36 Always check the pressure release devices for clogging before use.
- 37 To prevent risk of explosion and injury, only replace the dynamic seal ring as recommended by the manufacturer. Please refer to "Assembling your cooker", section 7, on page 11.
- 38 **WARNING:** Risk of Electric Shock. Cook only in removable container.

SAVE THESE INSTRUCTIONS

About the power cord

Your cooker has a polarized plug (one blade is wider than the other). To reduce the risk of electric shock, this plug is intended to fit into a polarized outlet only one way. If the plug does not fit fully into the outlet, reverse the plug. If it still does not fit, contact a qualified electrician. Do not attempt to modify the plug in any way.

Features

- 14 preset cooking functions make it easy to cook your favorite foods
- 24-hour timer lets you delay cooking until the perfect time
- Dishwasher-safe, nonstick pot makes cleanup easy
- Keep warm setting maintains your food at an ideal serving temperature
- Locking lid keeps the cooker closed while it's pressurized

Package contents

- 6 Qt. Multi-Function Pressure Cooker
- Rice scoop
- Soup ladle
- Measuring cup (3/4 C capacity)
- Condensation collector
- Stainless steel rack
- *User Guide*

Components

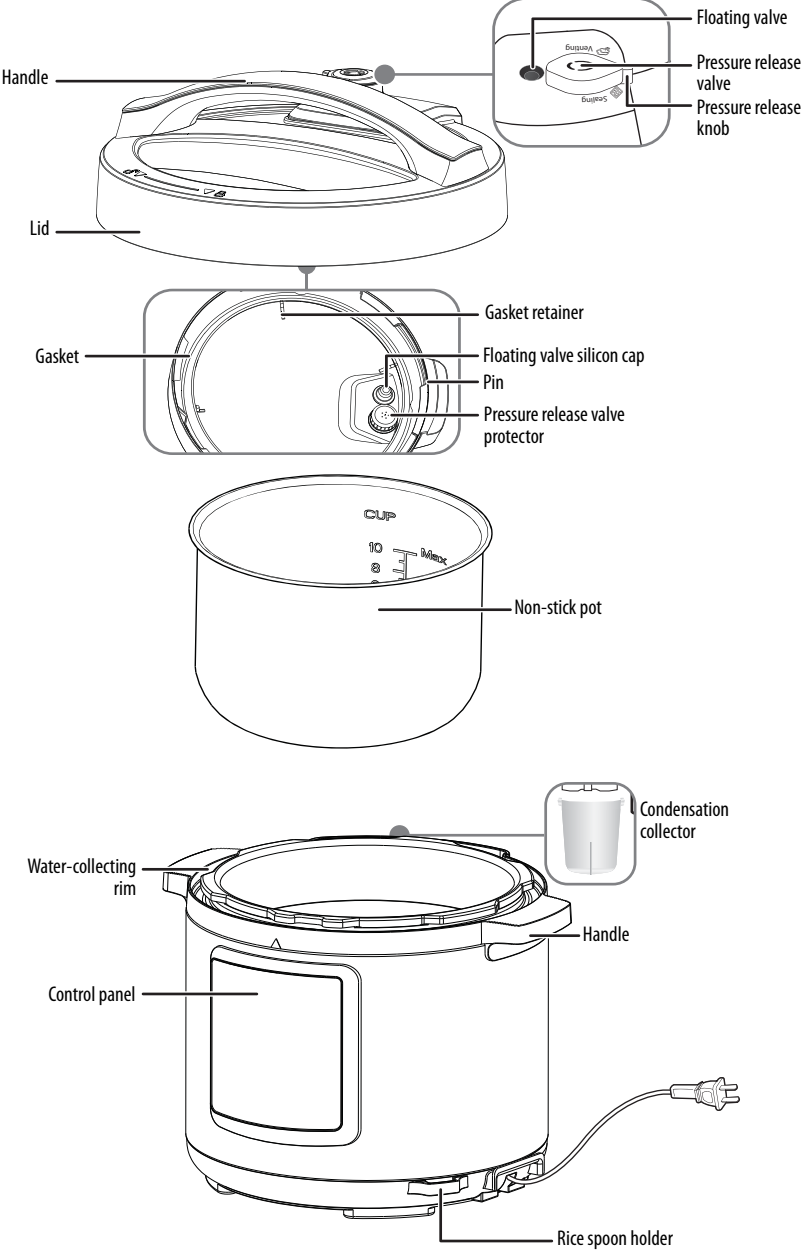

Control and display panel

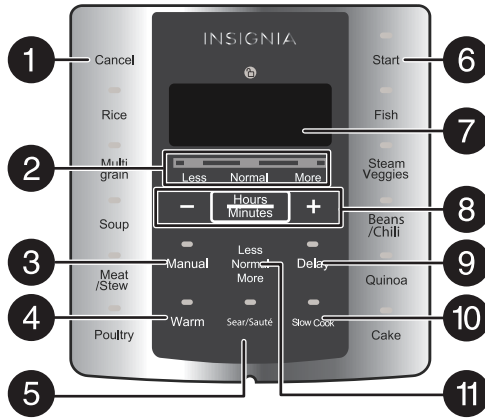

| # | ITEM | DESCRIPTION |
|----|------------------------------|--|
| 1 | Cancel button | Press to stop the cooking program and put your cooker in Standby mode. |
| 2 | Less/ Normal/ More Indicator | Shows the time level setting. |
| 3 | Manual button | Press to manually set the cook time. |
| 4 | Warm button | Press to keep your food warm. |
| 5 | Sear/Sauté | Press to sear/sauté your food. |
| 6 | Start button | Press to start a cooking program or the delay timer. The button flashes or lights steady depending on the state of the cooker. See Alert sounds, display messages, and lights on page 9. |
| 7 | Display | Shows cook times and other information. |
| 8 | Adjust time buttons | Press + or – to increase or decrease the cook or delay time. Press Hours/Minutes to switch between hours and minutes. |
| 9 | Delay timer button | Press to set a delayed start time. See Setting the delay timer on page 19. |
| 10 | Slow Cook | Press to slow cook your food (without pressure). |
| 11 | Less/Normal/ More | Press to manually adjust your cooker's time. |

Cook programs

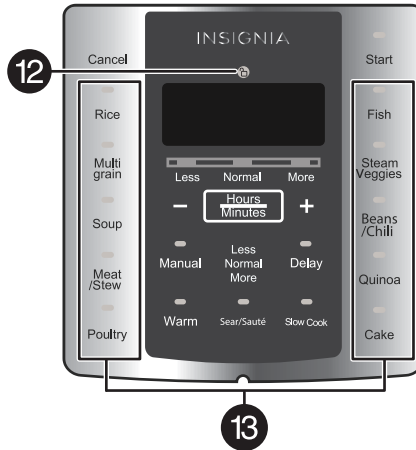

| # | ITEM | DESCRIPTION |
|----|---------------|---|
| 12 | Unlock icon | Lights to indicate when your cooker's lid is unlocked. |
| 13 | Cook programs | Press one of these buttons to select a cooking program: <ul style="list-style-type: none"> • Rice • Multi-grain • Soup • Meat/Stew • Poultry • Fish • Steam Veggies • Beans/Chili • Quinoa • Cake |

Accessories



Alert sounds, display messages, and lights

Your cooker uses sounds, lights, and display messages to tell you what is happening.

| ACTION | DISPLAY | SOUND | PROGRAM LIGHT | START LIGHT |
|--|--|-------------|---------------|-------------|
| Plug in your cooker | Flashing - - - - | One beep | Off | Off |
| Stand-by mode | Flashing - - - - | None | Off | Off |
| Close the lid | Flashing - - - - | Melody | Off | Off |
| Press program button | Default cooking time | One beep | Steady on | Flashing |
| Press program button, lid on cooker housing but not fully closed | Flashing - - - - and  | None | Off | Off |
| Press Manual | Cook time | One beep | Steady on | Flashing |
| Press program button, then Delay | Delay time | One beep | Steady on | Flashing |
| Press Start (with delay timer set) | Delay time | Three beeps | Steady on | Steady on |
| Press Start (without delay timer) | Circular flashing | Three beeps | Steady on | Steady on |
| Program starts ten seconds after being selected or after delay time ends | Circular flashing | Three beeps | Steady on | Steady on |
| Pressure builds up | Circular flashing | None | Steady on | Steady on |
| Program starts | Countdown timer | None | Steady on | Steady on |
| Program ends | OH | Ten beeps | Off | Off |
| Keep Warm starts | When turned on manually, the timer counts down the time you set. After a preset ends, the timer shows how long Warm has been running. | None | Steady on | Steady on |
| Keep Warm ends | Flashing - - - - | Ten beeps | Off | Off |
| Press Cancel | Flashing - - - - | One beep | Off | Off |
| Open the lid | Flashing - - - - | Melody | Off | Off |

Protection features

Your cooker has the following protections features:

| FEATURE | PURPOSE |
|----------------------------------|--|
| Lid lock | Locks the lid in place when enough pressure builds up inside your cooker. You cannot remove the lid until the pressure level lowers to the required level. |
| Pressure release knob | Automatically releases pressure if excessive pressure builds up inside your cooker. |
| Pressure release valve protector | Sits on top of the inner pressure release valve to prevent food from entering and clogging the valve. |
| Floating valve | When pressure builds up inside your cooker, the floating valve pops up and prevents you from removing the lid. When the pressure drops, it drops down. You should wait for a while before opening the lid. |
| Gasket | Creates an air tight seal to maintain the pressure inside your cooker. If the pressure level exceeds the required level, the gasket expands to release pressure on the sides of the lid. |
| Condensation collector | Collects condensation during the cooking process to prevent condensation from interfering with other protection features. |
| Overheat protection | If the temperature exceeds the required level, turns off the heating element, display, and indicator lights. |

Setting up your cooker

Before using your cooker

DANGER OF SUFFOCATION: Packaging materials are not toys. Keep packaging materials, like plastic bags, foil, and foam, away from babies and children. Packaging materials can block airways and prevent breathing.

Note: Your cooker may produce an odor or emit smoke when you turn it on for the first time as it eliminates residues from the production process. This is normal and does not indicate a defect or hazard. Make sure that ventilation is ample.

- 1 Remove the exterior and interior packaging.
- 2 Make sure that the package contents are complete and in good condition. See [Package contents](#) on page 5.

Tips and hints for using your cooker

- Smaller food normally requires less cooking time than larger food.
- We recommend that you defrost frozen food before cooking to shorten the cook time.
- We recommend that you only use nylon, heat-proof plastic, or wooden cooking utensils. Metal utensils can damage the non-stick surface. Do not leave utensils in your cooker while you are using it.
- We recommend that you clean all used accessories after each use.
- To avoid scratching your cooker's surfaces, remove the shells from crustaceans or shellfish before cooking.
- Do not use the Delay timer or Warm programs for recipes which contain delicate foods or foods that can turn bad easily (for example, raw eggs or raw fish).
- Always make sure that you add at least one cup of liquid into the inner pot. Your cooker uses the liquid to create the steam needed to build up pressure.
- Do not use oil or oil-based liquids under pressure. Small amounts of oil added to the water do not cause a problem.
- When using wine, add an equivalent amount of water because the wine evaporates too quickly.
- The cook time countdown only starts when the internal pressure and temperature reach suitable levels.
- When cooking under pressure, the food continues to cook after the cook time has elapsed. If you are not sure how long the food needs to cook, reduce the cook time and use the quick release method to remove the lid. When the cooking program ends, open the lid and check for doneness. Cook longer, if needed.
- When cooking beans, add a teaspoon of oil to the water to reduce the amount of foam.
- Meat cuts of lesser quality are tougher, but they are better suited for cooking under pressure. The pressure breaks down fibers and makes the meat tender.
- You cannot adjust the cooking temperature.

Assembling your cooker

The floating valve, silicon cap, pressure release valve, pressure release valve protector, and gasket come pre-installed on your cooker. If for some reason these parts are not installed, follow the steps below.

- 1 Put the lid on a clean, flat, and stable surface.
- 2 Insert the floating valve into its opening.

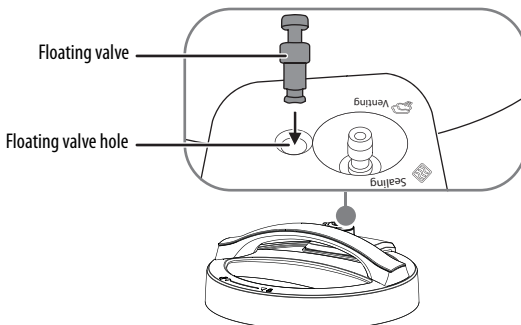

- Put the pressure release valve into the vent on the lid.

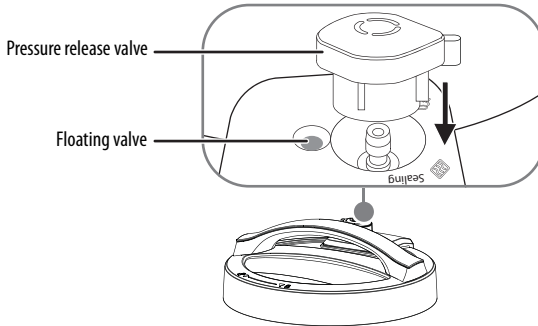

- Put a finger over the floating valve to keep it in position, then turn the lid upside down.
- On the bottom side of the lid, attach the silicon cap on the floating valve with the other hand, then release the floating valve.

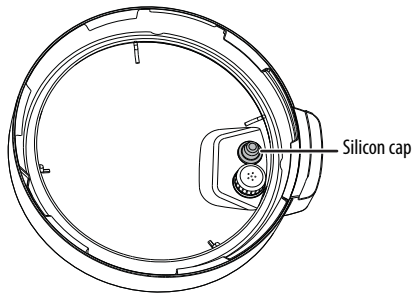

- Put the valve protector on the inner side of the pressure release valve.

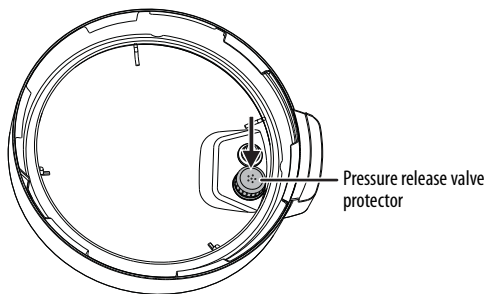

- 7 Install the gasket on the gasket retainer into the lid. Make sure that the gasket is correctly installed all around the retainer.

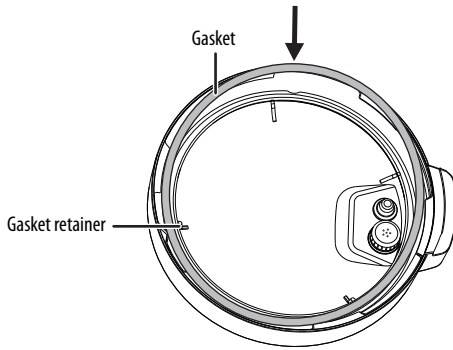

- 8 Slide the condensation collector in place on the back of your cooker.

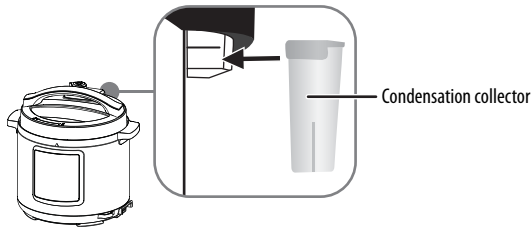

Positioning your cooker

- Make sure that your cooker has at least six inches of open space on all sides.
- When using your cooker, make sure that you provide at least 12" (30 cm) of headroom above your cooker to protect surfaces from damage due to hot steam.
- Make sure that the air vents at the bottom of your cooker are free from obstruction.

Using your cooker

You can use your cooker to:

- Cook rice
- Prepare soups and stews
- Cook meats like chicken or stew
- Slow cook meals
- Warm food
- Sear or sauté food
- Bake cakes



WARNINGS:

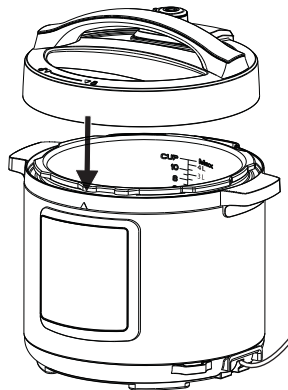

- Do not put sealed products, like canned vegetables, in your cooker. They can expand or explode when they get hot and cause damage or injury.
- Your cooker has a power rating of 1,000W. Make sure that the electrical circuit you plug your cooker into is not overloaded with other appliances.
- Plug your cooker into a separate 120V, 60Hz power outlet. Do not plug anything else into the outlet.
- Do not use an extension cord.
- If you use your cooker on a wooden surface, put it on a heat-resistant mat to protect the wood.

Closing the lid

- 1 Put the lid on top of your cooker. Make sure that no food residue is stuck between the lid and your cooker.



- 2 Align the  (unlock symbol) on the lid with the  on the top front of your cooker.

- 3 Rotate the lid clockwise until the  (lock symbol) on the lid aligns with the  on the top front of your cooker. Make sure that the pin on the back edge of the lid is fully retracted into the lid. If the pin is visible, the lid is not closed correctly.

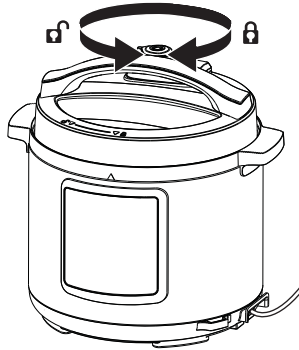

Opening the lid

WARNINGS:

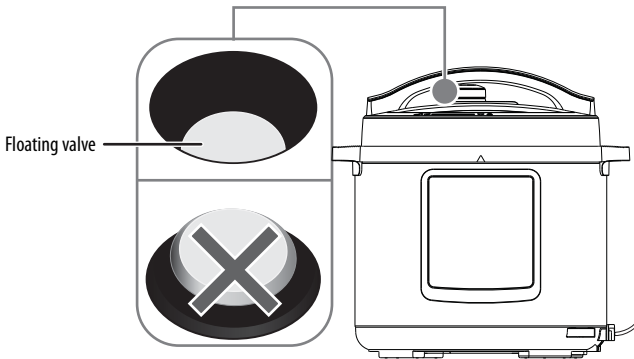

- Do not try to open the lid when the floating valve is popped up. Wait until your cooker has cooled and the valve has dropped down.

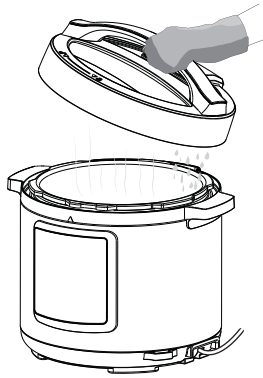

- We recommend that you wait a few minutes after the floating valve drops down. The internal pressure may still be higher than the outside pressure. Opening the lid too quickly can create a pressure differential and eject hot food and liquids towards the outside which can cause burns.
- If you cannot wait for the valve to drop, use the quick release method to open the lid. See [Using the quick release method to open the lid](#) on page 20.

- We recommend that you use oven mitts when handling your cooker or the lid. Escaping steam can burn.



- 1 Rotate the lid counter-clockwise until the  (unlock symbol) on the lid aligns with the  on the top front of your cooker.
- 2 As you open the lid, tilt it so that steam is diverted away from you.

Filling with food

CAUTION: Do not put food directly into the inner housing. Always put food into the inner pot. If you do not use the inner pot or use another container instead, you can damage your cooker.

- 1 Fill the inner pot with your ingredients. Do not overfill the inner pot. Do not exceed the Max marking which applies to solids and liquids combined.

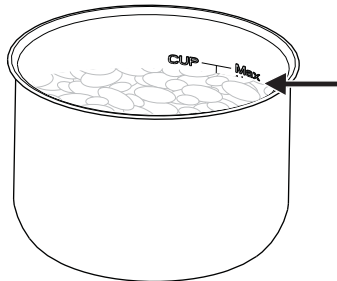

- When filling the inner pot, remember that some foods, like beans, rice, and pasta, expand during the cooking process. Plan accordingly.
- Overfilling can cause valves to clog and excess pressure to develop.
- Always make sure that you have filled the pot to at least the 2-cup marking inside the inner pot.

| FOOD | MAXIMUM VOLUME (INNER POT CAPACITY) | EXAMPLE |
|-------------------|--|------------------|
| Solid food | 2/3 | Meat, vegetables |
| Only liquids | 1/2 | Soup |
| Food that foams | 1/2 | Rice, pasta |
| Food that expands | 1/3 | Beans, lentils |

- Fill the inner pot with at least one cup of liquid (like water, juice, stock, or broth). Your cooker needs liquid to build up internal pressure. Use the provided measuring cup for easy volume measurement.
- Make sure that the outside of the inner pot is dry and free of debris, then put it into your cooker. Liquids on the outside of the pot can damage the heating element.
- Make sure that the inner pot is level with the cooker housing and that no objects remain between the inner pot and the inner housing.
- Put the lid on your cooker, then lock the lid in place. See [Closing the lid](#) on page 14.
- Make sure that the pressure release knob is in the sealing position .

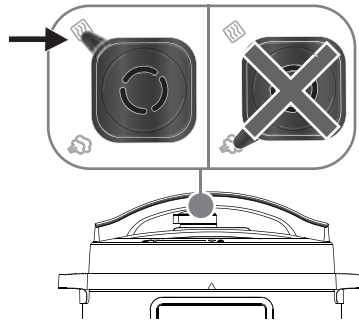

- Plug the power cord into a power outlet. Your cooker turns on and goes into Standby mode.
- Follow the instructions in [Selecting a cooking program and cook time](#) on page 18.

Selecting a cooking program and cook time

You can select from the following cooking programs. You can change the cooking time to suit your own tastes, different food quantities, and food manufacturer's instructions.

| PROGRAMS | DEFAULT COOKING TIME | | | COOKING TIME RANGE | INCREASE/DECREASE | DELAY TIMER | KEEP WARM AFTER PROGRAM ENDS |
|---------------|----------------------|---------|---------|--------------------|-------------------|--------------------|------------------------------|
| | Less | Normal | More | | | | |
| Rice | — | | | — | — | 10 min. to 24 hrs. | 12 hrs. |
| Multi-grain | 20 min. | 35 min. | 1 hr. | 1 min. to 2 hrs. | 1 min. | 10 min. to 24 hrs. | 12 hrs. |
| Soup | 20 min. | 35 min. | 1 hr. | 1 min. to 2 hrs. | 1 min. | 10 min. to 24 hrs. | 12 hrs. |
| Meat/Stew | 15 min. | 30 min. | 1 hr. | 1 min. to 2 hrs. | 1 min. | 10 min. to 24 hrs. | 12 hrs. |
| Poultry | 10 min. | 20 min. | 40 min. | 1 min. to 2 hrs. | 1 min. | 10 min. to 24 hrs. | 12 hrs. |
| Fish | 3 min. | 10 min. | 30 min. | 1 min. to 2 hrs. | 1 min. | 10 min. to 24 hrs. | 12 hrs. |
| Steam veggies | 5 min. | 20 min. | 40 min. | 1 min. to 2 hrs. | 1 min. | 10 min. to 24 hrs. | 12 hrs. |
| Beans/Chili | 25 min. | 35 min. | 1 hr. | 1 min. to 2 hrs. | 1 min. | 10 min. to 24 hrs. | 12 hrs. |
| Quinoa | 12 min. | 20 min. | 40 min. | 1 min. to 2 hrs. | 1 min. | 10 min. to 24 hrs. | 12 hrs. |
| Cake | 35 min. | 40 min. | 50 min. | 1 min. to 2 hrs. | 1 min. | 10 min. to 24 hrs. | 12 hrs. |
| Manual | 15 min. | 30 min. | 1 hr. | 1 min. to 2 hrs. | 1 min. | 10 min. to 24 hrs. | 12 hrs. |
| Warm | 1 hr. | 2 hrs. | 8 hrs. | 10 min. to 24 hrs. | 1 hr./10 min. | — | — |
| Sear/Sauté | 30 min. | | | — | — | — | — |
| Slow cook | 2 hrs. | 4 hrs. | 10 hrs. | 30 min. to 20 hrs. | 1 hr./10 min. | 10 min. to 24 hrs. | 12 hrs. |

- 1 Put the inner pot, filled with ingredients, into your cooker.
- 2 Plug the power cord into a power outlet.
- 3 Put the lid on your cooker, then lock the lid in place. See [Closing the lid](#) on page 14.

- 4 Press a cooking program button. The default cooking time appears on the display.
- 5 If you want to change the default cooking time, press + or -. If you do not adjust the time within 10 seconds of pressing a program button, your cooker uses the default time.

Notes:

- You cannot adjust the default cooking time for the Rice program. Depending on the amount of food you are cooking, your cooker automatically sets the cooking time (from 14 to 18 minutes) once the correct pressure is reached.
- You can use the Warm program to reheat food or keep cooked food warm. Make sure that you add enough liquid to the inner pot to keep food from burning.

- 6 Press the **Start** button. When the internal pressure reaches the correct level, the countdown timer starts. The Warm and Slow Cook programs do not use pressure so the countdown timer starts immediately.

Setting the delay timer

You can prepare food for cooking, then set a delayed start time from 10 minutes to 24 hours.

- 1 Select a cooking program, then adjust the time if needed. See [Selecting a cooking program and cook time](#) on page 18.
- 2 Press **Delay** once to turn on the delay timer. The default setting is two hours.
- 3 Press + or - to adjust the hours (in 1-hour increments).
- 4 Press **Hours/Minutes** to select minutes, then press + or - to adjust the minutes (in 10-hour increments).
- 5 Press **Start** or wait 10 seconds to start the delay countdown timer. When the delay time elapses, your cooker starts heating. When the internal pressure reaches the correct level, the cook countdown timer starts.

Notes:

- You cannot use the Delay timer with the Warm or Sear/Sauté program.
- To adjust or cancel the delay time, press the **Cancel** button, then select a cooking program, cook time, and delay time. See [Selecting a cooking program and cook time](#) on page 18.

Cooking**WARNINGS:**

- During use, your cooker may release steam to keep an appropriate pressure level. Keep your hands and face clear of escaping steam to avoid burns.
- When hot, always use oven mitts when handling your cooker and its accessories.
- To avoid excess pressure buildup and possible damage to your cooker, do not cover the lid, pressure release valve, floating valve, or air vents.

- 1 Put your ingredients into the inner pot, then put the pot into your cooker. See [Filling with food](#) on page 16. Make sure that the outside of the pot is dry and free of debris.
- 2 Close and lock the lid. See [Closing the lid](#) on page 14.

- 3 Press a cooking program button, then adjust the cook or delay time (if needed). See [Selecting a cooking program and cook time](#) on page 18 or [Setting the delay timer](#) on page 19.
- 4 Press the **Start** button or wait 10 seconds. Your cooker starts heating. When the internal pressure reaches the correct level, the countdown timer starts. When cooking is complete, the Warm program automatically starts. The default setting is 12 hours. You cannot adjust this time.

Note: To stop the Warm program, press **Cancel**, then unplug the power cord.

WARNING: We recommend that you wait a few minutes after the floating valve drops down. The internal pressure may still be higher than the outside pressure. Opening the lid too quickly can create a pressure differential and eject hot food and liquids towards the outside which can cause burns.

- 5 Press the **Cancel** button and unplug the power cord.
- 6 Let your cooker cool down before you open the lid. The floating valve on the lid drops down when the pressure has decreased.
- 7 Use oven mitts to open the lid. Follow the instructions and warnings in [Opening the lid](#) on page 15.
- 8 Carefully remove the food using suitable utensils and put it into a dish using the provided rice scoop, soup ladle, or other utensils.
- 9 Let your cooker cool down completely before cleaning it. See [Cleaning your cooker](#) on page 24.
- 10 Empty and clean the condensation reservoir after every use.
- 11 Inspect all protection features and clean after every use. See [Protection features](#) on page 10 and [Cleaning your cooker](#) on page 24.
- 12 Make sure that the gasket is intact and does not show any deformation.

Using the quick release method to open the lid

After the cook time has elapsed, the temperature and pressure inside your cooker slowly reduce. However, in the case of delicate food, you can release the pressure more quickly to keep the food from overcooking.

WARNINGS:

- Always use oven mitts because your cooker is hot and escaping steam can burn.
- Keep your face and hands clear of the pressure release valve before releasing the pressure contained inside your cooker. Do not stand in the steam venting trajectory.
- Do not use the quick release method when cooking only liquids or liquids with a small amount of solid food. Liquids can be ejected with the steam through the pressure release knob.

- 1 Press **Cancel** and unplug the power cord.
- 2 Rotate the pressure release knob on the top of the lid all the way to the venting position . The pressure release knob releases steam.

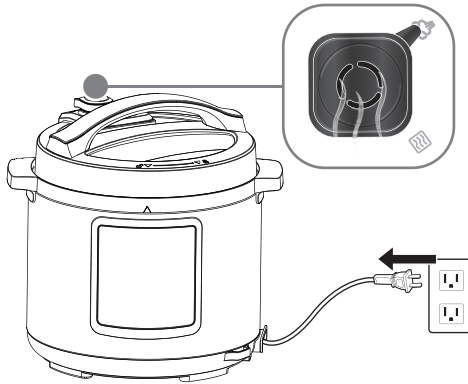

- 3 Use oven mitts to open the lid. Follow the instructions and warnings in [Opening the lid](#) on page 15.
- 4 Carefully remove the food using suitable utensils and put it into a dish using the provided rice scoop, soup ladle, or other utensils.
- 5 Let your cooker cool down completely before cleaning it. See [Cleaning your cooker](#) on page 24.
- 6 Empty and clean the condensation reservoir after every use.

Steaming vegetables or fish

WARNING: The cooking stand gets hot during use. Let it cool down before removing it or use suitable utensils to remove it.

- 1 Pour about two cups of water into the inner pot.
- 2 Put the cooking stand into the inner pot. Make sure that the outside of the cooking pot is dry and free of debris. Make sure that water does not reach the top of the stand.

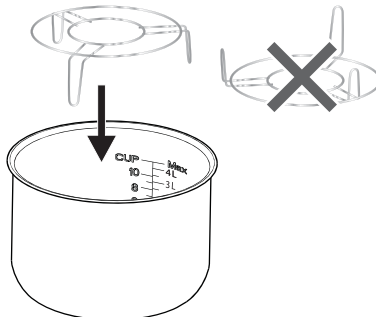

- Put the vegetables or fish into a suitable heat-resistant dish, then put the dish on the cooking stand. Make sure that the food does not contact the water.

Note: For small food or cooked rice, use a heat-resistant bowl for easy handling.

- Close and lock the lid. See [Closing the lid](#) on page 14.
- Press **Steam Veggies**, then adjust the cook or delay time (if needed). See [Selecting a cooking program and cook time](#) on page 18 or [Setting the delay timer](#) on page 19.
- Press **Start** or wait 10 seconds. Your cooker starts heating. When the internal pressure reaches the correct level, the countdown timer starts.
- When cooking is complete, press **Cancel**, then unplug your cooker.
- Use oven mitts to open the lid. Follow the instructions and warnings in [Opening the lid](#) on page 15.
- Carefully remove the food using suitable utensils and put it into a dish using the provided rice scoop, soup ladle, or other utensil.
- Let your cooker cool down completely before cleaning it. See [Cleaning your cooker](#) on page 24.
- Empty and clean the condensation reservoir after every use.

Searing or sautéing food

You can sear or sauté food with or without the lid. After 30 minutes, the Sear/Sauté program ends. You cannot adjust the cook or delay time.

WARNING: Do not leave your cooker unattended when using the Sear/Sauté program.

- Pour cooking oil into the inner pot, then put the inner pot into your cooker.
- Press **Sear/Sauté**, then press **Start** or wait 10 seconds.
- Let your cooker preheat for about one to two minutes.
- Put the food into the hot oil using suitable utensils, then let the food brown evenly. If you do not use the lid, check continuously to make sure that there is enough oil into the inner pot. Do not let the inner pot boil dry.
- If you use the lid, close and lock the lid. See [Closing the lid](#) on page 14.
- When cooking is complete, press **Cancel**, then unplug the power cord.
- If you used the lid, use oven mitts to open the lid. Follow the instructions and warnings in [Opening the lid](#) on page 15.
- If you want to add ingredients after you finish searing or sautéing, let your cooker cool for three to five minutes, then close the lid and select another cooking program.
- Carefully remove the food using suitable utensils and put it into a dish using the provided rice scoop, soup ladle, or other utensils.
- Let your cooker cool down completely before cleaning it. See [Cleaning your cooker](#) on page 24.
- Empty and clean the condensation reservoir after every use.

Making a cake

- 1 Mix the cake ingredients ahead of time, stirring the cake into a paste.
- 2 Put the cake mixture into the inner pot, then put the pot into your cooker. See [Filling with food](#) on page 16. Make sure that the outside of the pot is dry and free of debris.
- 3 Close and lock the lid. See [Closing the lid](#) on page 14.
- 4 Press **Cake**, then adjust the cook or delay time (if needed). See [Selecting a cooking program and cook time](#) on page 18 or [Setting the delay timer](#) on page 19.
- 5 Press **Start** or wait 10 seconds. Your cooker starts heating. When the internal pressure reaches the correct level, the countdown timer starts.
- 6 When cooking is complete, the Warm program automatically starts. The default setting is 12 hours. You cannot adjust this time.
- 7 Press **Cancel** and unplug the power cord.
- 8 Let your cooker cool down before you open the lid. The floating valve on the lid drops down when the pressure has decreased.
- 9 Use oven mitts to open the lid. Follow the instructions and warnings in [Opening the lid](#) on page 15.
- 10 Carefully remove the cake using suitable utensils and put it into a dish using the provided rice scoop, soup ladle, or other utensils.
- 11 Let your cooker cool down completely before cleaning it. See [Cleaning your cooker](#) on page 24.
- 12 Empty and clean the condensation reservoir after every use.

Cleaning your cooker

You should clean your cooker after every use.

WARNING: To avoid electric shocks or damage to your cooker, always press the **Stop** button and unplug the power cord before cleaning. Make sure that all parts of your cooker have cooled down completely.

CAUTIONS:

- Do not immerse the power cord or your cooker in water or any other liquids.
 - Do not use abrasive cleaners, steel wool, or scouring pads.
 - Dry all parts thoroughly after cleaning, before using, or before storing your cooker.
 - Make sure that no water enters your cooker's housing or the control panel.
 - The lid is not dishwasher safe.
 - Clean the pressure release valve and pressure release valve protector only if you see a residue buildup.
 - Make sure that all parts and surfaces are completely dry before connecting your cooker to a power outlet. Wet parts can cause an electric shock.
- 1 Remove the inner pot and condensation collector from your cooker.
 - 2 Wash the inner pot, condensation collector, and any used accessories (like the measuring cup, rice scoop, soup ladle, and cooking stand) with hot soapy water. Rinse and dry carefully. You can also wash these items in a dishwasher.
 - 3 Turn the lid upside down and put it on a clean, flat, and stable surface.
 - 4 Remove the gasket by pulling it away from the lid.
 - 5 Check the pressure release valve protector, pressure release valve, and floating valve for residue. Only remove and clean these items if needed.
 - 6 If you need to clean the floating valve, put one hand under the lid and push up the floating valve. Remove the floating valve silicon cap with the other hand. Release and grab the floating valve with the hand under the lid.
 - 7 Wash the gasket, pressure release valve, pressure release valve protector, floating valve, and silicon cap with hot soapy water. Rinse and dry carefully. You can also wash these items in a dishwasher.
 - 8 Wipe the inner and outer housings, control panel, and lid with a damp cloth. Take extra care when cleaning near the heating element and control panel. Water can damage them. Dry these parts thoroughly after cleaning. Do not immerse them in water.



Storing your cooker

When storing your cooker:

- Make sure that your cooker and all parts are completely cool, clean, and dry.
- We recommend that you store your cooker in a dry place.
- Store your cooker on a stable shelf or in a cupboard to prevent it from falling.
- To avoid accidents, make sure that both your cooker and its power cord are beyond reach of children or pets.

Troubleshooting

| PROBLEM | SOLUTION |
|---|--|
| My cooker is not working. | <ul style="list-style-type: none"> • Make sure that the power cord is plugged in and that the power outlet is working. If the outlet is not working, check the circuit breaker and reset if necessary. • Your cooker may have overheated. Unplug the power cord from the power outlet, let your cooker cool, then try using it again. |
| I cannot close the lid. | <ul style="list-style-type: none"> • If the floating valve is out (popped up), check the valve for residue, then clean the valve if necessary. • If the floating valve is damaged, take your cooker to a Best Buy authorized service center for repair. |
| My cooker heats up, but the display or the buttons do not light up. | <ul style="list-style-type: none"> • Press the Cancel button, then unplug the power cord from the power outlet. Take your cooker to a Best Buy authorized service center for repair. |
| The display and buttons light up, but my cooker does not heat. | <ul style="list-style-type: none"> • Press the Cancel button, then unplug the power cord from the power outlet. Take your cooker to a Best Buy authorized service center for repair. |
| The floating valve does not pop up. | <ul style="list-style-type: none"> • There may not be enough liquid to create sufficient pressure. Press the Cancel button, then unplug the power cord from the power outlet. Use the quick release method to release any built up pressure and let your cooker cool before opening it. See Using the quick release method to open the lid on page 20. Add liquid, then try again. • Residue may be blocking the valve. Press the Cancel button, then unplug the power cord from the power outlet. Use the quick release method to release any built up pressure and let your cooker cool before opening it. See Using the quick release method to open the lid on page 20. Clean the valve, then try again. |
| Steam is continually released from the pressure release valve. | <ul style="list-style-type: none"> • The release valve may not be seated correctly. Press the Cancel button, then unplug the power cord from the power outlet. Wait until the steam flow stops, then use oven mitts to push the valve down. • The release valve may be damaged. Press the Cancel button, then unplug the power cord from the power outlet. Take your cooker to a Best Buy authorized service center for repair. • Your cooker may be building up too much pressure. Press the Cancel button, then unplug the power cord from the power outlet. Take your cooker to a Best Buy authorized service center for repair. |

| PROBLEM | SOLUTION |
|---|---|
| Steam leaks from the floating valve after it pops up. | <ul style="list-style-type: none"> • Residue may be blocking the valve. Press the Cancel button, then unplug the power cord from the power outlet. Use the quick release method to release any built up pressure and let your cooker cool before opening it. See Using the quick release method to open the lid on page 20. Clean the valve, then try again. • The silicon cap on the floating valve may be damaged. Press the Cancel button, then unplug the power cord from the power outlet. Take your cooker to a Best Buy authorized service center for repair. • Your cooker may be building up too much pressure. Press the Cancel button, then unplug the power cord from the power outlet. Take your cooker to a Best Buy authorized service center for repair. |
| Steam leaks from the sides of the lid. | <ul style="list-style-type: none"> • The lid may not be closed correctly. Press the Cancel button, then unplug the power cord from the power outlet. Wait until the steam flow stops, then use oven mitts to rotate the lid so that the  (lock symbol) is aligned with the  on the top front of your cooker. • The sealing gasket may be missing. Press the Cancel button, then unplug the power cord from the power outlet. Use the quick release method to release any built up pressure and let your cooker cool before opening it. See Using the quick release method to open the lid on page 20. Install the sealing gasket, then try again. • The sealing gasket may be damaged. Press the Cancel button, then unplug the power cord from the power outlet. Take your cooker to a Best Buy authorized service center for repair. • Residue between the sealing gasket and lid may be preventing a good seal. Press the Cancel button, then unplug the power cord from the power outlet. Use the quick release method to release any built up pressure and let your cooker cool before opening it. See Using the quick release method to open the lid on page 20. Clean the residue from the gasket and lid, then try again. |
| I cannot open the lid. | <ul style="list-style-type: none"> • If the floating valve is popped up, wait until the valve drops down. You can use the quick release method with oven mitts to open the lid. See Using the quick release method to open the lid on page 20. • The floating valve may be damaged. Press the Cancel button, then unplug the power cord from the power outlet. Use the quick release method to release any built up pressure and let your cooker cool before opening it. See Using the quick release method to open the lid on page 20. Take your cooker to a Best Buy authorized service center for repair. |

| PROBLEM | SOLUTION |
|--|---|
| My cooker is producing an odor or smoke. | <ul style="list-style-type: none"> • Your cooker may produce an odor or emit smoke when you turn it on for the first time as it eliminates residues from the production process. This is normal. Put the inner pot inside your cooker, then fill the pot with at least two cups of water. Let your cooker heat for at least 10 minutes without the lid or food until the odor and smoke are eliminated. • If this is not the first time you turned on your cooker, it may be damaged. Press the Cancel button, then unplug the power cord from the power outlet. Use the quick release method to release any built up pressure and let your cooker cool before opening it. See Using the quick release method to open the lid on page 20. Take your cooker to a Best Buy authorized service center for repair. |

Specifications

| | |
|------------------------|--|
| Volume | 6 qt. (24 C) (5.7 L) |
| Dimensions (H × W × D) | 12.6 × 13.0 × 12.2 in. (32 × 33 × 31 cm) |
| Weight | 11.9 lbs. (5.4 kg) |
| Power | 120V ~ 60 Hz |
| Power consumption | 1,000W |
| Power cord length | 30.7 in. (78 cm) |

ONE-YEAR LIMITED WARRANTY

Definitions:

The Distributor* of Insignia branded products warrants to you, the original purchaser of this new Insignia-branded product ("Product"), that the Product shall be free of defects in the original manufacturer of the material or workmanship for a period of one (1) year from the date of your purchase of the Product ("Warranty Period").

For this warranty to apply, your Product must be purchased in the United States or Canada from a Best Buy branded retail store or online at www.bestbuy.com or www.bestbuy.ca and is packaged with this warranty statement.

How long does the coverage last?

The Warranty Period lasts for 1 year (365 days) from the date you purchased the Product. Your purchase date is printed on the receipt you received with the Product.

What does this warranty cover?

During the Warranty Period, if the original manufacture of the material or workmanship of the Product is determined to be defective by an authorized Insignia repair center or store personnel, Insignia will (at its sole option): (1) repair the Product with new or rebuilt parts; or (2) replace the Product at no charge with new or rebuilt comparable products or parts. Products and parts replaced under this warranty become the property of Insignia and are not returned to you. If service of Products or parts are required after the Warranty Period expires, you must pay all labor and parts charges. This warranty lasts as long as you own your Insignia Product during the Warranty Period. Warranty coverage terminates if you sell or otherwise transfer the Product.

How to obtain warranty service?

If you purchased the Product at a Best Buy retail store location or from a Best Buy online website (www.bestbuy.com or www.bestbuy.ca), please take your original receipt and the Product to any Best Buy store. Make sure that you place the Product in its original packaging or packaging that provides the same amount of protection as the original packaging.

To obtain warranty service, in the United States call 1-888-BESTBUY or in Canada call 1-866-BESTBUY. Call agents may diagnose and correct the issue over the phone.

Where is the warranty valid?

This warranty is valid only in the United States and Canada at Best Buy branded retail stores or websites to the original purchaser of the product in the county where the original purchase was made.

What does the warranty not cover?

This warranty does not cover:

- Customer instruction/education
- Installation
- Set up adjustments
- Cosmetic damage
- Damage due to weather, lightning, and other acts of God, such as power surges
- Accidental damage
- Misuse
- Abuse
- Negligence
- Commercial purposes/use, including but not limited to use in a place of business or in communal areas of a multiple dwelling condominium or apartment complex, or otherwise used in a place of other than a private home.
- Modification of any part of the Product, including the antenna
- Display panel damaged by static (non-moving) images applied for lengthy periods (burn-in).
- Damage due to incorrect operation or maintenance

- Connection to an incorrect voltage or power supply
- Attempted repair by any person not authorized by Insignia to service the Product
- Products sold "as is" or "with all faults"
- Consumables, including but not limited to batteries (i.e. AA, AAA, C, etc.)
- Products where the factory applied serial number has been altered or removed
- Loss or Theft of this product or any part of the product
- Display panels containing up to three (3) pixel failures (dots that are dark or incorrectly illuminated) grouped in an area smaller than one tenth (1/10) of the display size or up to five (5) pixel failures throughout the display. (Pixel based displays may contain a limited number of pixels that may not function normally.)
- Failures or Damage caused by any contact including but not limited to liquids, gels or pastes.

REPAIR REPLACEMENT AS PROVIDED UNDER THIS WARRANTY IS YOUR EXCLUSIVE REMEDY FOR BREACH OF WARRANTY. INSIGNIA SHALL NOT BE LIABLE FOR ANY INCIDENTAL OR CONSEQUENTIAL DAMAGES FOR THE BREACH OF ANY EXPRESS OR IMPLIED WARRANTY ON THIS PRODUCT, INCLUDING, BUT NOT LIMITED TO, LOST DATA, LOSS OF USE OF YOUR PRODUCT, LOST BUSINESS OR LOST PROFITS. INSIGNIA PRODUCTS MAKES NO OTHER EXPRESS WARRANTIES WITH RESPECT TO THE PRODUCT, ALL EXPRESS AND IMPLIED WARRANTIES FOR THE PRODUCT, INCLUDING BUT NOT LIMITED TO ANY IMPLIED WARRANTIES OF AND CONDITIONS OF MERCHANTABILITY AND FITNESS FOR A PARTICULAR PURPOSE, ARE LIMITED IN DURATION TO THE WARRANTY PERIOD SET FORTH ABOVE AND NO WARRANTIES, WHETHER EXPRESS OR IMPLIED, WILL APPLY AFTER THE WARRANTY PERIOD. SOME STATES, PROVINCES AND JURISDICTIONS DO NOT ALLOW LIMITATIONS ON HOW LONG AN IMPLIED WARRANTY LASTS, SO THE ABOVE LIMITATION MAY NOT APPLY TO YOU. THIS WARRANTY GIVES YOU SPECIFIC LEGAL RIGHTS, AND YOU MAY ALSO HAVE OTHER RIGHTS, WHICH VARY FROM STATE TO STATE OR PROVINCE TO PROVINCE.

Contact Insignia:

1-877-467-4289

www.insigniaproducts.com

INSIGNIA is a trademark of Best Buy and its affiliated companies.

*Distributed by Best Buy Purchasing, LLC

7601 Penn Ave South, Richfield, MN 55423 U.S.A.

©2018 Best Buy. All rights reserved.

Made in China

INSIGNIA™

www.insigniaproducts.com

1-877-467-4289 (U.S. and Canada) or 01-800-926-3000 (Mexico)

INSIGNIA is a trademark of Best Buy and its affiliated companies.

Distributed by Best Buy Purchasing, LLC

7601 Penn Ave South, Richfield, MN 55423 U.S.A.

©2018 Best Buy. All rights reserved.

Made in China

V1 ENGLISH
18-0383