

# Fixed Soundbar Mount

NS-SBFXB26

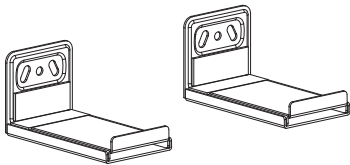

Before using your new product, please read these instructions to prevent any damage.

## Contents

Introduction .....	3
Important Safety Instructions .....	3
Features .....	4
Package contents .....	4
Mounting hardware .....	4
Product dimensions .....	7
You will need (Not provided) .....	8
Installing your fixed soundbar mount. ....	9
Step 1 - Determining the mounting bracket height ...	9
Step 2: Option A - Determining width for threaded inserts .....	11
Step 2: Option B - Determining width for shelf-style. .	12
Step 3: Option A - Mounting to wood studs. ....	14
Step 3: Option B - Mounting to drywall .....	17
Step 3: Option C - Mounting to a concrete wall .....	20
Mounting your soundbar .....	24
Step 4: Mounting with the shelf-style. ....	25
Specifications. ....	27
ONE-YEAR LIMITED WARRANTY. ....	28

## Introduction

Congratulations on your purchase of a high-quality Insignia product. Your NS-SBFXB26 represents the state of the art in soundbar mount design and is designed for reliable and trouble-free performance.

## Important Safety Instructions

**Read all instructions before use.**

**Keep these instructions.**



### **CAUTION**

- Never let children climb on or play with your product.
- Do not sit or stand on your product.
- Do not place a soundbar that is heavier than the recommended rated load on the stand. Improper installation may cause property damage and/or personal injury. The manufacturer is not liable for damage or injury caused by incorrect mounting, assembly, or use.
- Improper handling can result in cuts and lacerations.
- Pictures are for reference only, subject to our available products.



## CAUTION

This bracket is suitable for items weighing no more than the “maximum load of 22 lbs. (10 kg).” The wall must be able to bear four times the total weight of the bracket and the audio cable. Do not over-tighten the screws to avoid injury. Using products with a weight exceeding the indicated maximum weight may cause the bracket and its accessories to collapse, potentially causing injury.

## Features

- Adjustable design supports most soundbars between 4.13 – 6.3 in. (10.5 – 16 cm) deep
- Durable steel brackets hold up to 22 lbs. (10 kg)
- Silicone padding cushions your soundbar
- Included hardware provides everything you need for simple installation

## Package contents

- Mounting bracket (2)
- Installation hardware
- *Installation Guide*







## Mounting hardware





## WARNING

This product contains small items that could be a choking hazard if swallowed. Before starting assembly, verify all parts are included and undamaged.

**Note:** Not all hardware will be used.

LABEL	HARDWARE	QUANTITY
1	 M5 × 40 lag bolt	4
2	 Wall anchor	4
3	 Hex wrench	1
A	 Mounting bracket	2
B	 M4 × 16 screw	2
C	 M5 × 16 screw	2
D	 M6 × 16 screw	2

LABEL	HARDWARE	QUANTITY
<b>E</b>	 M4/M5 washer	<b>2</b>
<b>F</b>	 M6 washer	<b>2</b>

## Product dimensions

**Front view**

2.36 in. (60 mm)

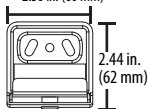
**Side view**

Fully extended:

6.30 in. (160 mm)

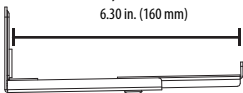
**Top view**

4.41 in.

(112 mm)

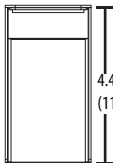
**Side view**

Fully closed:

4.13 in. (105 mm)

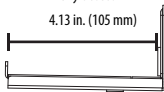

## You will need (Not provided)

You will need the following tools to assemble your new fixed soundbar mount:



Pencil



Tape measure



Hammer



3/8 in. (10 mm) masonry  
drill bit



Bubble level



1/8 in. (3 mm) wood  
drill bit



Stud finder



#2 Phillips screwdriver



Electric drill

## Installing your fixed soundbar mount

### Step 1 - Determining the mounting bracket height

- 1 Position your soundbar on the mounting bracket as if it were attached, then measure the distance from the top of your soundbar to the mounting hole on the back of the mounting bracket. This is measurement **A**.

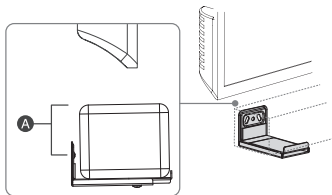

- 2 Decide the desired height for the top of the soundbar and measure to the bottom of your TV. This is measurement **B**.

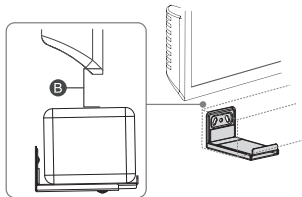

**Notes:**

- Select a mounting position low enough for your soundbar to fit under the TV, allowing for easy insertion and removal.
- Make sure to center your soundbar under the TV.

- 3** Add measurements **A** and **B**, then mark the total height with a pencil. This is the height for the mounting brackets.

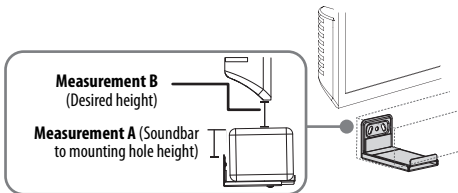
**Notes:**

- Make sure that your mounting area can bear up to four times the weight of the mounting bracket. The mounting brackets are suitable for loads up to 22 lbs. (10 kg).
- Your soundbar is for vertical wall mounting only. Do not install on a ceiling.

- 4** Choose your mounting surface:

- If you are mounting your soundbar to one or two wood studs, see [Step 3: Option A - Mounting to wood studs](#) on page 14.
- If you are mounting your soundbar to drywall, see [Step 3: Option B - Mounting to drywall](#) on page 17.

- If you are mounting your soundbar to concrete, see [Step 3: Option C - Mounting to a concrete wall](#) on page 20.

## Step 2: Option A - Determining width for threaded inserts

- 1 Measure the distance between the two threaded inserts on the bottom of your soundbar.

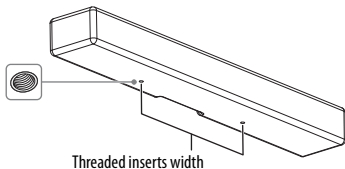

- 2 Choose your mounting surface:

- If you are mounting your soundbar to one or two wood studs, see [Step 3: Option A - Mounting to wood studs](#) on page 14.
- If you are mounting your soundbar to drywall, see [Step 3: Option B - Mounting to drywall](#) on page 17.
- If you are mounting your soundbar to concrete, see [Step 3: Option C - Mounting to a concrete wall](#) on page 20.

**Note:** When mounting, make sure that the mounting brackets are centered and level under your TV.

## Step 2: Option B - Determining width for shelf-style

- 1 Measure in from both edges of your soundbar to determine the preferred mounting bracket width. A distance of 2 - 5 in. (50.8 - 127 mm) from each edge is recommended.

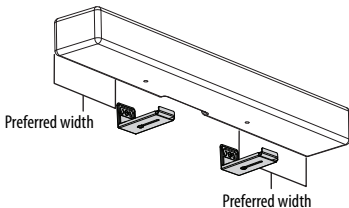

- 2 Check the position of the connection panel on the back of your soundbar to make sure that the proposed position of the mounting brackets (A) is not blocking the holes, then determine the position of the brackets (A) to avoid any interference.

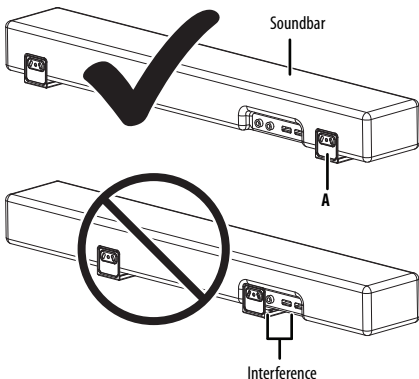

- 3 Choose your mounting surface:

- If you are mounting your soundbar to one or two wood studs, see [Step 3: Option A - Mounting to wood studs](#) on page 14.
- If you are mounting your soundbar to drywall, see [Step 3: Option B - Mounting to drywall](#) on page 17.

- If you are mounting your soundbar to concrete, see Step 3: Option C - Mounting to a concrete wall on page 20.

**Note:** When mounting, make sure that the mounting brackets (A) are centered and level under your TV.

## Step 3: Option A - Mounting to wood studs

You will need the following if you are mounting on wood studs:



Pencil



1/8 in. (3 mm) wood drill bit



3/8 in. (10 mm) masonry drill bit



Hammer



Stud finder



#2 Phillips screwdriver



2 Wall anchor (2)



Electric drill



1 M5 x 40 lag bolt (2)



### CAUTION

The minimum wood stud size is 2 x 4 in. (38 mm x 89 mm) and the surface covering cannot be more than 5/8 in. (15.9 mm). Drill holes in the middle of the wooden studs.

- 1** Use a stud finder to locate two wood studs that match your measured bracket width, then mark the drill positions with a pencil.

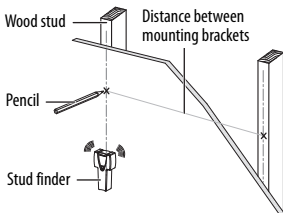

- 2** Make sure that the marks are level, then drill a hole into the marked stud(s) with a 1/8 in. (3 mm) wood drill bit to a depth of 1 3/4 in. (45 mm).

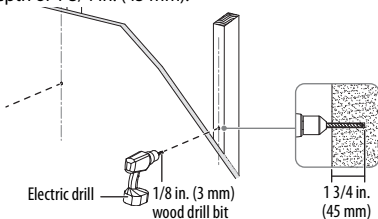

- 3 OPTIONAL:** If you are mounting one side to drywall, see [Step 3: Option B - Mounting to drywall](#) on page 17:

**Note:** If you are using two wood studs, skip this step.

- 4** Position the brackets over the pre-drilled holes, insert the M5 × 40 lag bolts (1) into the center hole (as shown), then tighten with a #2 Phillips screwdriver.

**Notes:**

- Use a level before fully tightening the M5 × 40 lag bolts (1).
- Do not use the provided wall anchors (2) if you are mounting to a wood stud.

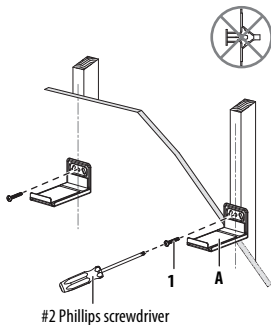

### Step 3: Option B - Mounting to drywall

You will need the following if you are installing on drywall:



Pencil



#2 Phillips screwdriver



Electric drill



3/8 in. (10 mm) masonry  
drill bit



1 M5 x 40 lag  
bolt (4)



Hammer



2 Wall anchor (4)

- 1 After determining the width of the mounting brackets (A) in Step 2: Option B - Determining width for shelf-style on page 12, measure the width on the wall and mark the drill positions with a pencil.

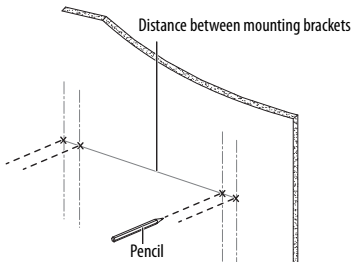

- 2** Make sure that the marks are level, then drill four holes into the wall using a 3/8 in. (10 mm) masonry drill bit.

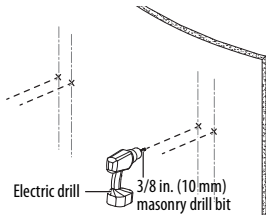

- 3** Fold the four wall anchors (2) in the middle so the position of the "wings" is flat and vertical to avoid interference between them, then gently tap them into the pre-drilled holes with a hammer.

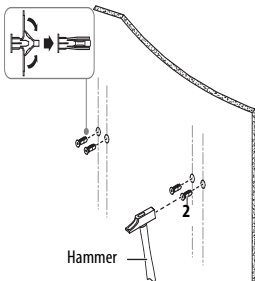

- 4 Position the mounting brackets (**A**) over the pre-drilled holes and insert the four M5 × 40 lag bolts (**1**) into the wall anchors with a #2 Phillips screwdriver.

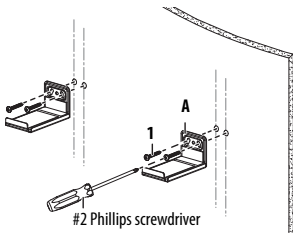

- 5 The holes in the mounting brackets (**A**) are slots that allow for some adjustment to level them. Make sure that the mounting brackets (**A**) are level, then tighten the M5 × 40 lag bolts (**1**).

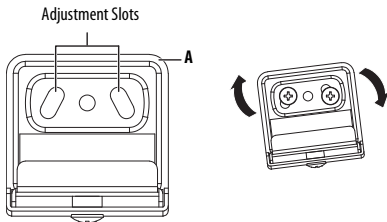

## Step 3: Option C - Mounting to a concrete wall

You will need the following if you are installing on a concrete wall:



Pencil



#2 Phillips screwdriver



Electric drill



3/8 in. (10 mm) masonry  
drill bit



1 M5 x 40 lag  
bolt (4)



Hammer



2 Wall anchor (4)



### CAUTION

Check the wall strength before mounting to a concrete wall.

- 1 Mark the drill hole positions with a pencil using the previously determined height and width measurements.

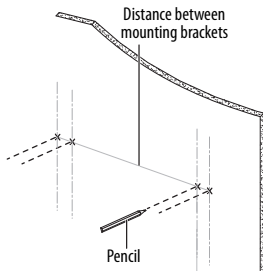

- 2 Make sure that the marks are level, then drill four holes into the wall using a  $\frac{3}{8}$  in. (10 mm) masonry drill bit to a depth of  $1 \frac{3}{4}$  in. (45 mm).

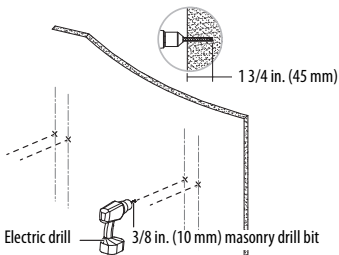

- 3** Fold the four wall anchors (2) in the middle so the position of the “wings” is flat and vertical to avoid interference between them, then gently tap them into the pre-drilled holes with a hammer.

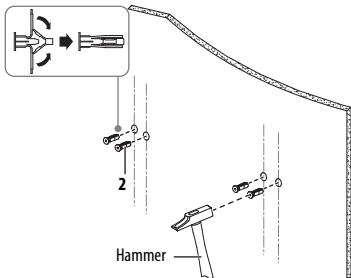

- 4 Position the mounting brackets (**A**) over the pre-drilled holes and insert the M5 × 40 lag bolts (**1**) into the four wall anchors (**2**) with a #2 Phillips screwdriver.

**Note:** Use a level before fully tightening the M5 × 40 lag bolts (**1**).

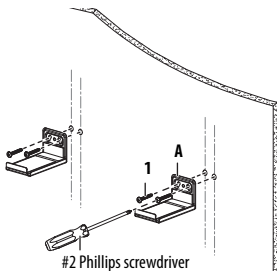

- 5** The holes in the mounting brackets (**A**) are slots that allow for some adjustment to level them. Make sure that the mounting brackets (**A**) are level, then tighten the M5 × 40 lag bolts (**1**).

Adjustment Slots

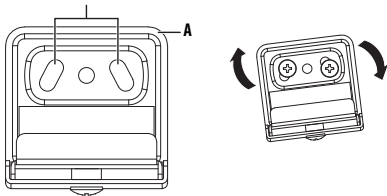

## Mounting your soundbar

- 1** Make sure that the mounting brackets (**A**) are level, stable, and centered under your TV.

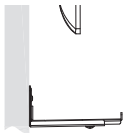

- 2 Use the provided hex wrench (3) to loosen the adjusting screw, then adjust the length of both mounting brackets (A) as necessary and re-tighten.

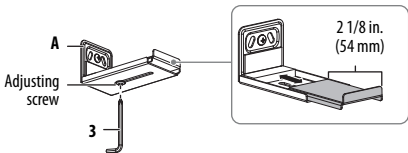

#### Step 4: Mounting with the shelf-style

- 1 Connect the two soundbar equipment cables to the back of your soundbar.

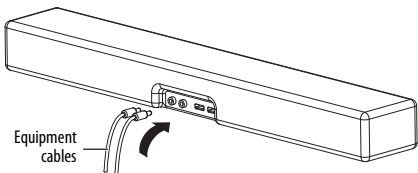

- 2 Place your soundbar evenly on top of the mounting brackets (**A**).

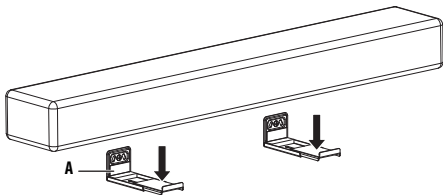

## Specifications

Dimensions (H × W × D)	2.44 × 2.36 × 4.13 – 6.3 in. (6.2 × 6 × 10.5 – 16 cm)
Maximum capacity	22 lbs. (10 kg)
Weight	<b>Net:</b> 1.12 lbs (.50 kg) <b>Gross:</b> 1.25 lbs (.56 kg)
Color	Black

## ONE-YEAR LIMITED WARRANTY

Best Buy, or its Authorized Partner of Insignia branded products, warrants to you, the original purchaser of this new Insignia branded product ("Product"), that the Product shall be free of defects in the original manufacture of the material or workmanship for a period of one (1) year from the date of your purchase of the Product or the date of delivery (if later than the date of purchase) ("Warranty Period").

For this warranty to apply, your Product must be (i) purchased in the United States or Canada from a Best Buy branded retail store, online at [www.bestbuy.com](http://www.bestbuy.com) or [www.bestbuy.ca](http://www.bestbuy.ca), or from Best Buy's Authorized Partner, and (ii) packaged or sold with this warranty statement.

The term "Best Buy", as used in this warranty, refers to Best Buy branded retail stores, [www.bestbuy.com](http://www.bestbuy.com), [www.bestbuy.ca](http://www.bestbuy.ca), and Best Buy's Authorized Partner.

Because Insignia cannot control the quality of products sold by unauthorized sellers, this warranty applies only to Products that were purchased from Best Buy or an Insignia Authorized Partner, unless otherwise prohibited by law. Insignia reserves the right to reject warranty claims for Products purchased from unauthorized sellers, including unauthorized websites.

REPAIR OR REPLACEMENT, AS PROVIDED UNDER THIS WARRANTY, IS YOUR EXCLUSIVE REMEDY FOR BREACH OF WARRANTY. INSIGNIA SHALL NOT BE LIABLE FOR ANY INCIDENTAL OR CONSEQUENTIAL DAMAGES FOR THE BREACH OF ANY EXPRESSED OR IMPLIED WARRANTY ON THIS PRODUCT, INCLUDING, BUT NOT LIMITED TO, LOST DATA, LOSS OF USE OF YOUR PRODUCT, LOST BUSINESS, OR LOST PROFITS. INSIGNIA PRODUCTS MAKES NO OTHER EXPRESS WARRANTIES WITH RESPECT TO THE PRODUCT. ALL EXPRESSED AND IMPLIED WARRANTIES FOR THE PRODUCT, INCLUDING BUT NOT LIMITED TO ANY IMPLIED WARRANTIES OF AND CONDITIONS OF MERCHANTABILITY AND FITNESS FOR A PARTICULAR PURPOSE, ARE LIMITED IN DURATION TO THE WARRANTY PERIOD SET FORTH ABOVE

AND NO WARRANTIES, WHETHER EXPRESSED OR IMPLIED, WILL APPLY AFTER THE WARRANTY PERIOD. SOME STATES, PROVINCES, AND JURISDICTIONS DO NOT ALLOW LIMITATIONS ON (i) HOW LONG AN IMPLIED WARRANTY LASTS, (ii) EXCLUSION OR LIMITATION OF INCIDENTAL OR CONSEQUENTIAL DAMAGES, or (iii) LIMITATION OF INCIDENTAL OR CONSEQUENTIAL DAMAGES, SO THE ABOVE LIMITATIONS OR EXCLUSIONS MAY NOT APPLY TO YOU. THIS WARRANTY GIVES YOU SPECIFIC LEGAL RIGHTS, AND YOU MAY ALSO HAVE OTHER RIGHTS, WHICH VARY FROM STATE TO STATE OR PROVINCE TO PROVINCE.

### ***How long does the coverage last?***

The Warranty Period lasts for 1 year (365 days) from the date you purchased the Product or the date of delivery (if later than the date of purchase). Your purchase date is printed on the receipt you received with the Product. In the event that Authorized Partner ceases to sell the covered Insignia branded product, this warranty shall terminate for that product and there shall be no repair or replacement of the Product.

### ***What does this warranty cover?***

During the Warranty Period, if the original manufacture of the material or workmanship of the Product is determined to be defective by an authorized Insignia repair center or store personnel, Insignia will (at its sole option): (1) repair the Product with new or rebuilt parts; or (2) replace the Product at no charge with new or rebuilt comparable products or parts. Products and parts replaced under this warranty become the property of Insignia and are not returned to you. If service of Products or parts are required after the Warranty Period expires, you must pay all labor and parts charges. This warranty lasts as long as you own your Insignia Product during the Warranty Period. Warranty coverage terminates if you sell or otherwise transfer the Product.

### ***How to obtain warranty service?***

If you purchased the Product at a Best Buy retail store location or from a Best Buy online website ([www.bestbuy.com](http://www.bestbuy.com) or [www.bestbuy.ca](http://www.bestbuy.ca)), please take your original receipt and the Product to any Best Buy store. Make sure that you place the Product in its

original packaging or packaging that provides the same amount of protection as the original packaging. If you purchased your Product from an Authorized Partner, call Insignia at 1-877-467-4289.

To obtain warranty service, in the United States and Canada call 1-877-467-4289. Call agents may diagnose and correct the issue over the phone.

If you purchased the Product from an Authorized Partner other than Best Buy, please call 1-888-BESTBUY in the United States or 1-866-BESTBUY in Canada. You will be asked to provide proof of purchase and to return your Product to Best Buy. Make sure that you put the Product in its original packaging or packaging that provides the same amount of protection as the original packaging.

### ***Where is the warranty valid?***

This warranty is valid only in the United States and Canada to the original purchaser of the product from an Authorized Partner, in the country where the original purchase was made.

### ***What does the warranty not cover?***

- Food, beverage, and/or medicine loss/spoilage.
- Damage to other products caused by a power surge or other similar issue while connected to the Product.
- Customer instruction/education.
- Installation.
- Set up adjustments.
- Cosmetic damage.
- Damage due to weather, lightning, and other acts of God, such as power surges.
- Accidental damage.
- Misuse.
- Abuse.
- Negligence.
- Commercial purposes/use, including but not limited to use in a place of business or in communal areas of a multiple dwelling condominium or apartment complex, or otherwise used in a place of other than a private home.
- Modification of any part of the Product, including the antenna.
- Display panel damaged by static (non-moving) images applied for lengthy periods (burn-in).

- Damage due to incorrect operation or maintenance.
- Connection to an incorrect voltage or power supply.
- Damage due to attempted repair by any person not authorized by Insignia to service the Product.
- Products sold "as is" or "with all faults".
- Consumables, including but not limited to batteries (i.e. AA, AAA, C etc.).
- Products where the factory applied serial number has been altered or removed.
- Loss or Theft of this product or any part of the product.
- Display panels containing up to three (3) pixel failures (dots that are dark or incorrectly illuminated) grouped in an area smaller than one tenth (1/10) of the display size or up to five (5) pixel failures throughout the display. (Pixel based displays may contain a limited number of pixels that may not function normally).
- Failures or Damage caused by any contact including but not limited to liquids, gels or pastes.

1-877-467-4289 | [www.insigniaproducts.com](http://www.insigniaproducts.com)

INSIGNIA is a trademark of Best Buy and its affiliated companies.

Distributed by Best Buy Purchasing, LLC

Richfield, MN 55423 U.S.A

©2025 Best Buy. All rights reserved.

INSIGNIA™

**[www.insigniaproducts.com](http://www.insigniaproducts.com)**

1-877-467-4289 (U.S. and Canada)



INSIGNIA is a trademark of Best Buy and its affiliated companies.

Distributed by Best Buy Purchasing, LLC

7601 Penn Ave South, Richfield, MN 55423 U.S.A.

©2025 Best Buy. All rights reserved.

V1 ENGLISH  
25-0729