

LED POD

STL2X4PDL



2X4-INCH LED POD LIGHT

User Manual

BOX CONTENTS

- ◆ Two (2) LED Pod lights
- ◆ Two (2) 18-inch harness with Deutsch connectors
- ◆ Two (2) Stinger Black-out covers
- ◆ Two (2) Amber lens covers
- ◆ Two (2) Pod light mounting brackets
- ◆ Mounting hardware

FEATURES

- ◆ Trail-ready compact design
- ◆ High-output LED light engine
- ◆ Durable HEXCORE aluminium housing
- ◆ Driving beam pattern
- ◆ White or Amber backlit halo
- ◆ Weather-sealed design for harsh environments
- ◆ Universal mounting system

TECHNICAL SPECIFICATIONS

- ◆ Operating Voltage: 10-30V DC
- ◆ Light Source: High-intensity LEDs
- ◆ Housing Material: Die-cast aluminium
- ◆ Lens Material: Polycarbonate
- ◆ Ingress Protection: IP67
- ◆ Operating Temperature: -40°F to 149°F (-40°C to 65°C)

REQUIRED TOOLS

- 13mm wrench or 13mm socket and ratchet
- 4mm Allen wrench
- Wire crimpers / stripper

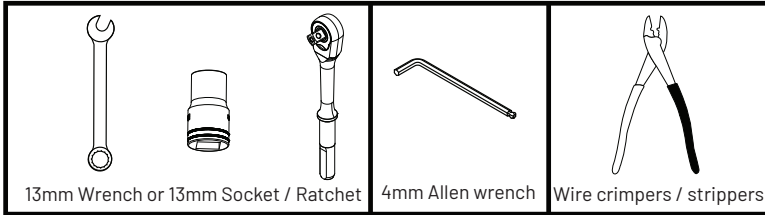

WIRING

PIN	WIRE COLOR	FUNCTION	VEHICLE WIRING
PIN 1	Yellow	Amber position light	External 12V switch
PIN 2	White	White position light	External 12V switch
PIN 3	Green	Low beam switch	External 12V switch
PIN 4	N/A	No connection	No connection
PIN 5	Black	Ground	Chassis ground
PIN 6	Red	Hi beam power	External 12V switch



Connector is shown from the PIN side



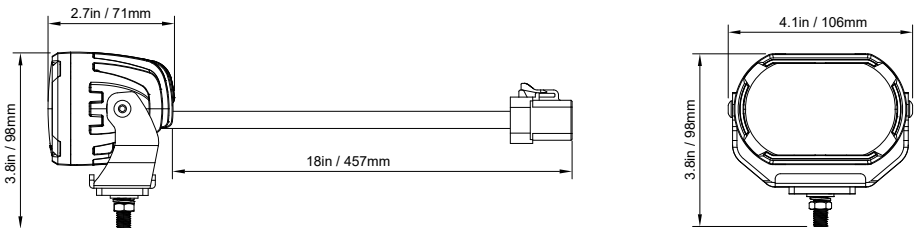





DIMENSIONS

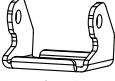
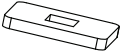

Installation Guide

MOUNTING HARDWARE

- Two (2) Mounting Brackets
- Two (2) Rubber Spacers
- Four (4) M6 X 20mm Black Stainless Bolts
- Four (4) M6 Rubber Washers
- Four (4) M6 Lock Washers
- Two (2) M8 X 25mm Black Stainless Bolts
- Two (2) M8 Flat Washers
- Two (2) M8 Lock Washers
- Two (2) M8 Stainless Nuts

 Mounting Bracket	 Rubber Spacer	 M6X 20 BOLT	 M6 RUBBER WASHER	 M6 LOCK WASHER
 M8 X 25 BOLT	 M8 FLAT WASHER	 M8 LOCK WASHER	 M8 NUT	

- Choose a secure, vibration-free mounting surface (bumper, roof rack, A-pillar, etc.).
- Ensure the lights do not obstruct airflow, visibility, or vehicle components.
- Attach the mounting brackets to the pod light.
- Loosely secure hardware to allow for beam adjustment.
- Mount the assembly to the vehicle using the provided hardware.

Installation Guide

- ◆ Connect the red wire to a positive (+) 12V switch for Hi beam.
- ◆ Connect the green wire to a positive (+) 12V switch for Low beam. (Red wire must also be powered)
- ◆ Connect the black wire to a clean chassis ground.
- ◆ Connect the yellow wire to a positive (+) 12V switch for Amber halo.
- ◆ Connect the white wire to a positive (+) 12V switch for White halo.

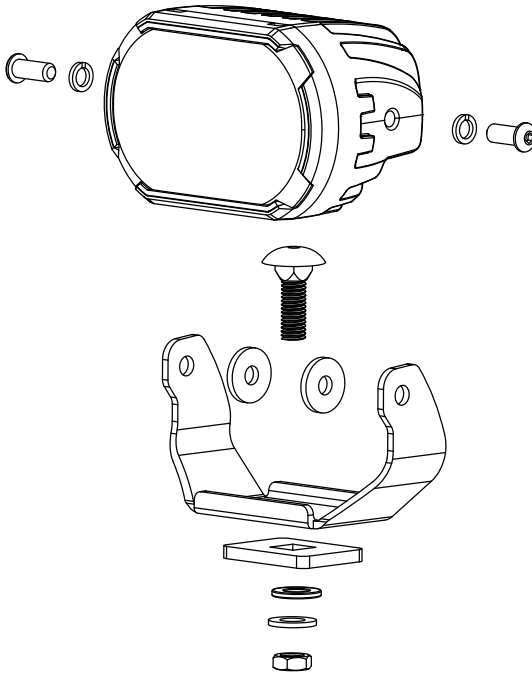



Register Your Product



<https://stingerdrive.com/pages/hexcore-registration>

