

msi® MAG A750BN PCIE5 III

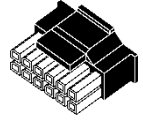

SPECIFICATIONS

Product Name	MAG A750BN PCIE5 III
Form Factor	ATX
Power Wattage	750W
Efficiency Rating	80 PLUS Bronze (up to 85%)
Modularity	Non-Modular
Fan Size	120 mm
Fan Bearing	Hydraulic bearing
Dimensions (D x W x H)	140 x 150 x 86 mm / 5.51 x 5.9 x 3.38 inches
PFC Type	Active PFC
Input Voltage Range	100-240V~
Input Frequency Range	50-60Hz
Protection	OVP, OCP, SCP, OPP, UVP

- *ATX 3.1 Ready, PCIe 5.1 Ready*
- *120mm Fan*
- *Half Bridge+ DC to DC*
- *Active PFC Design*
- *12V Single Rail*
- *Black Embossed UL Certified Cable*
- *Copper Alloy Terminal*
- *Dual-color 12V-2x6 Cable*
- *Industrial level protection with OVP, OCP, SCP, OPP, UVP*

MAG A750BN PCIE5 III				
AC INPUT	100-240V~, 10-5A, 50-60Hz 200-240V~, 5A, 50-60Hz (Only for China and Korea)			
DC output	+5V	+3.3V	+12V	+5Vsb
	15.0A	15.0A	62.5A	2.5A
	100W		750W	12.5W
Total power	750W			

CONNECTORS					
ATX	EPS	PCIe 5.1 (12V-2x6)	PCIe (6+2 PIN)	SATA	PERIPHERAL
1	2	1 (450w)	3	3	2

Power Supply Cable

1 x ATX Black Embossed Cable

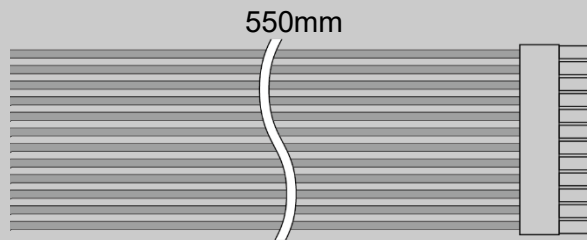

1 x EPS Black Embossed Cable

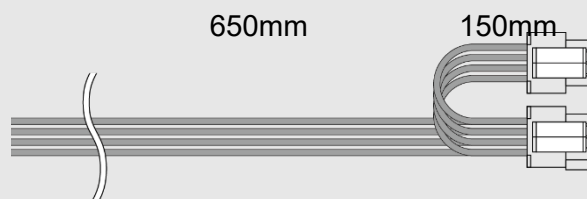

1 x PCIe 5.1 Black Embossed Cable

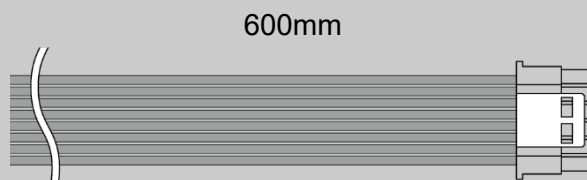

1 x PCIe Black Embossed Cable

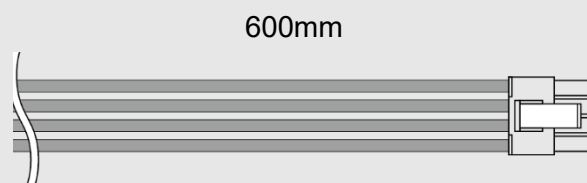

1 x PCIe (dual 8-pin) Black Embossed Cable

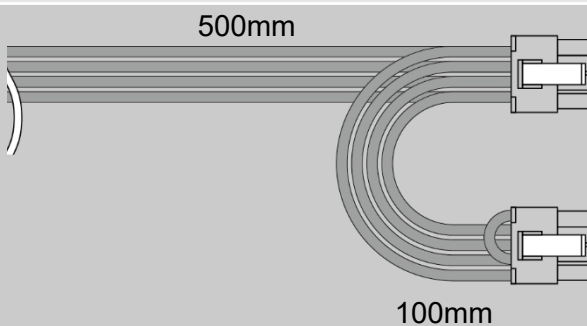

1 x SATA Black Embossed Cable

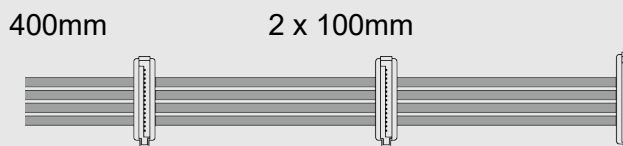

1 x PERIPHERAL Black Embossed Cable

