

User Manual (2~21)
Manual del usuario (22~41)
Manuel de l'utilisateur (42~61)

Warranty (62~63)

SmartBidet™

SB-3000 Electronic Bidet Seat

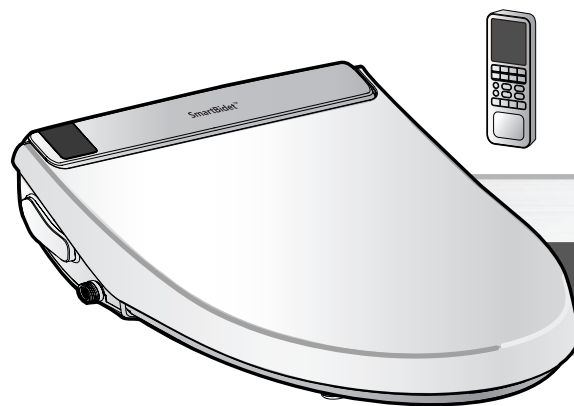

SB-3000

“Important safeguards/general cautions” are information that can protect the user from safety hazards and also prevent losses. Please be sure to read the manual correctly for proper usage.

- Please read the manual carefully before installation and utilization.
- This product is made for the US and Canada.
- The function and design of the product may be changed for quality improvements.

“Precauciones generales/protecciones importantes” es información que puede proteger al usuario de peligros de seguridad y también evitar pérdidas. Por favor asegure leer el manual correctamente para un uso adecuado.

- Por favor lea el manual cuidadosamente antes de la instalación y utilización.
- Este producto está fabricado para Canadá y los Estados Unidos.
- El diseño y función del producto puede ser cambiado para mejora de calidad.

Les **«Consignes de sécurité importantes / précautions générales»** sont des informations pouvant protéger l'utilisateur des dangers pour la sécurité et prévenir les pertes. Assurez-vous de lire le manuel correctement pour une utilisation correcte.

- Veuillez lire attentivement le manuel avant l'installation et l'utilisation.
- Ce produit est fabriqué pour les États-Unis et le Canada.
- La fonction et la conception du produit peuvent être modifiées pour améliorer la qualité.

Important Functions



SB-3000

SmartBidet™

ELECTRONIC TOILET SEAT SIÈGE DE TOILETTE ÉLECTRONIQUE ASIENTO DE INODORO ELECTRÓNICO

Simply Clean, Stainless Nozzle.
Simplemente Limpia. Tout Simplement Propre.
Inoxidable Boquilla. Inoxydable Buse.

3-in-1 Improved Hygienic Functions
3-en-1 Funciones Mejoradas de Higiene
3-in-1 Amélioration des Fonctions D'hygiène

Revolutionary Heated Seat & Warm Air Dryer
Asiento Térmico Revolucionario y Secador de Aire Caliente
Sièges Chauffants Révolutionnaire et Sécheuse Air Chaud



Heated Water
Eau chaude
Agua caliente



Adjustable Nozzle
Bec réglable
Boquilla ajustable



Heated Seat
Siege chauffant
Asiento calefaccionado



Warm Air Dryer
Sechoir a air chaud
Secador de aire caliente



Easy to Use
Facile a utiliser
Facil de Usar



Easy Installation
Installation facil
Facil instalacion



Soft Closing
Fermeture en douceur
Cierre suave



Child Wash
Lavar Niño
Laver L'enfant



Replaceable Nozzle A
buse remplaçable A
boquilla reemplazable A

Contents

Preparation

IMPORTANT SAFEGUARDS / GENERAL CAUTIONS	4
CAUTIONS BEFORE INSTALLATION	6

Operation & Cleaning

IDENTIFICATION	8
OPERATION (BASIC)	10
OPERATION (DETAILS)	12
INSTALLATION	15
WATER DRAINING/ SEPARATION OF THE UNIT FROM THE TOILET BOWL	18
MAINTENANCE	19

Other

Troubleshooting	20
Specifications	21

1 IMPORTANT SAFEGUARDS

● READ ALL INSTRUCTIONS BEFORE INSTALLATION AND USE

The following terms are used in this manual to indicate hazards of varying degrees of severity.

DANGER	Indicates an imminently hazardous situation which, if not avoided, will result in death or serious injury.
WARNING	Indicates potentially hazardous situation which, if not avoided, could result in death or serious injury.
CAUTION	Indicates potentially hazardous situation which, if not avoided, may result in minor or moderate injury or in damage to the product or other property.



DANGER - To reduce the risk of electrocution



WARNING - To reduce the risk of burns, electrocution, fire, or injury to persons



PLEASE OBSERVE THE FOLLOWING PRECAUTION BEFORE USING THIS PRODUCT



Do not dismantle

Do not open the product to repair or remodel.
Only qualified service personnel should service this product.
Do not use attachments not recommended by the manufacturer.



Prohibited

Connect this product to cold water supply pipe carrying potable water.
Do not connect to an industrial water supply line that does not carry water of drinking quality.
This will negatively effect hygiene and performance.

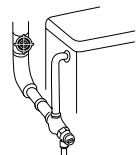

Prohibited

About Low Temperature Burns.

A burn occurs when the skin has been exposed to high temperatures. However, a low temperature burn may occur when the skin has been in contact with an object at relatively low temperature (about 104 °F). Close supervision is necessary when this product is used by children or adults with sensitive skin.



Prohibited

If using any chemical toilet bowl cleaner, be sure to wipe up any spills that splash onto Electric Bidet Seat.
Do not use benzene or any acid chemical detergent.
Only neutral detergent permitted.





Prohibited

Do not plug in the power cord before connecting the water supply hose.

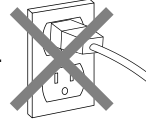

Grounding

This product must be grounded.
An approved Ground Fault Circuit Interrupt must be used.



Do not spray water

Do not splash water on this product.
Please provide adequate ventilation to avoid high levels of humidity which can damage the electronic components.
It is necessary to provide adequate ventilation with a fan, open door or open window when bathing.



Wet hands prohibited

Do not touch the power cord with wet hands.
Do not reach for a product that has fallen into water.
Unplug immediately!

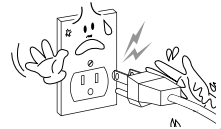

Observe at all times

This product must be connected to a standard voltage power source.
Do not connect power cord if the cord is damaged or broken.
Do not plug the unit into a loose electric outlet.

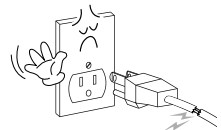

Observe at all times

Please disconnect the power cord when you clean this product or detach it from toilet bowl.
Do not supply electrical power to the unit until the plumbing work has been completed.

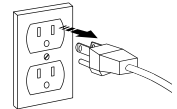

Use of fire prohibited

Keep the electrical cord away from heated surfaces to prevent a fire hazard.
Also, keep any flammable materials away from this product at all times.



1 IMPORTANT SAFEGUARDS



CAUTION



Prohibited

Never operate this product if it is not working properly, if it has been dropped or damaged, or dropped into water. Return the product to a service center for examination and repair.



Prohibited

Do not obstruct or put anything into the dry air outlet. Do not apply excessive force to the shower nozzle.



Prohibited

Do not stand or sit on the seat cover lid. It is not designed to support a user body weight.



Prohibited

Allow the seat and lid to close automatically. Do not force the lid closed.

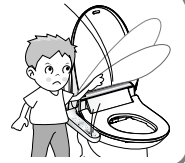

Prohibited

Do not strain or push the connected hose and tube connector; it may cause water leakage. Never drop or insert any object into any opening or hose. Use proper plumbing supplies if any modification is to be made.

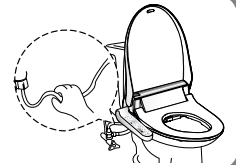

Observe at all times

Use this product only as described in the operating instructions. Never use while sleeping or drowsy. Do not use while bathing.



Observe at all times

Be careful so that this product does not become stained with excrement and urine.



Observe at all times

Drain the water from unit and unplug the power if this product is not going to be used for an extended period of time. Refer to page 21.

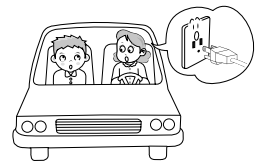

- SAVE THESE INSTRUCTIONS -

2 CAUTION BEFORE INSTALLATION

WIRING REQUIREMENT

THIS PRODUCT MUST BE PLUGGED into a regular voltage grounded GFCI outlet (North America 120Vac). The rated power consumption is 1400W. In locations where only a standard two-prong outlet is available, it is the responsibility of the user to install a grounded three-prong outlet. Using a higher voltage is dangerous and may result in a fire or other accident. This product is not responsible for damage resulting from the use of it on other than specified voltage, or operating it without proper grounding.



WARNING

This Product must be on a separate circuit. No other appliance should share the circuit with this product. Sharing a circuit could cause the branch circuit fuse to blow or the circuit breaker to trip. Continuous usage under these conditions could result in fire or property damage.

GROUND INSTRUCTIONS

- (1) This product has a three-prong grounding plug, which must be plugged into an outlet that is properly installed and grounded. In the event of an electrical short circuit, grounding reduces the risk of electric shock by providing an escape wire for the electric current. If repair or replacement of the cord or plug is necessary, do not connect the grounding wire to either flat blade terminal. The wire with insulation having an outer surface that is green with or without yellow stripes is the grounding wire. Check with a qualified electrician or service person if the grounding instructions are not completely understood, or if in doubt as to whether the product is properly grounded.
- (2) This product is for use on a nominal 120Vac circuit, and has a grounding plug that looks like the plug illustrated in sketch A in Figure 1. A temporary adapter, which looks like the adapter illustrated in sketches B and C, may be used to connect this plug to a 2-pole receptacle as shown in sketch B if a properly grounded outlet is not available. The temporary adapter should be used only until a properly grounded outlet (sketch A) can be installed by a qualified electrician. The green colored rigid ear, lug, or the like extending from the adapter must be connected to a permanent ground such as a properly grounded outlet box cover. Whenever the adapter is used, it must be held in place by the screw.

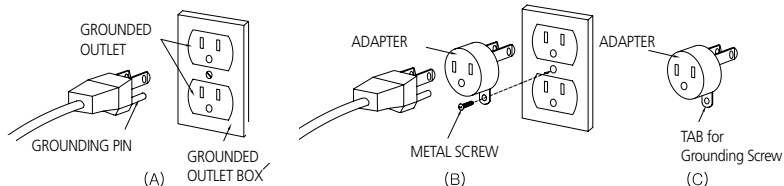

- Figure 1-

This appliance has to be grounded.



DANGER

IMPROPER GROUNDING CAN RESULT IN A RISK OF ELECTRIC SHOCK. Electric wiring has to be done in accordance with all local codes, or in the absence of local codes, with the National Electrical Codes.

The use of an extension cord is not recommended or advised. If it is necessary to use an extension cord, use only a three-prong extension cord (one to one), and a three slot built-in GFCI receptacle that will accept the plug on this product. The marked rating of the extension cord should be equal to or greater than the electrical rating of the unit (10amp). Consult a qualified electrician or service person if you are not sure whether the unit is properly grounded.

3 Identification

1 MAIN UNIT

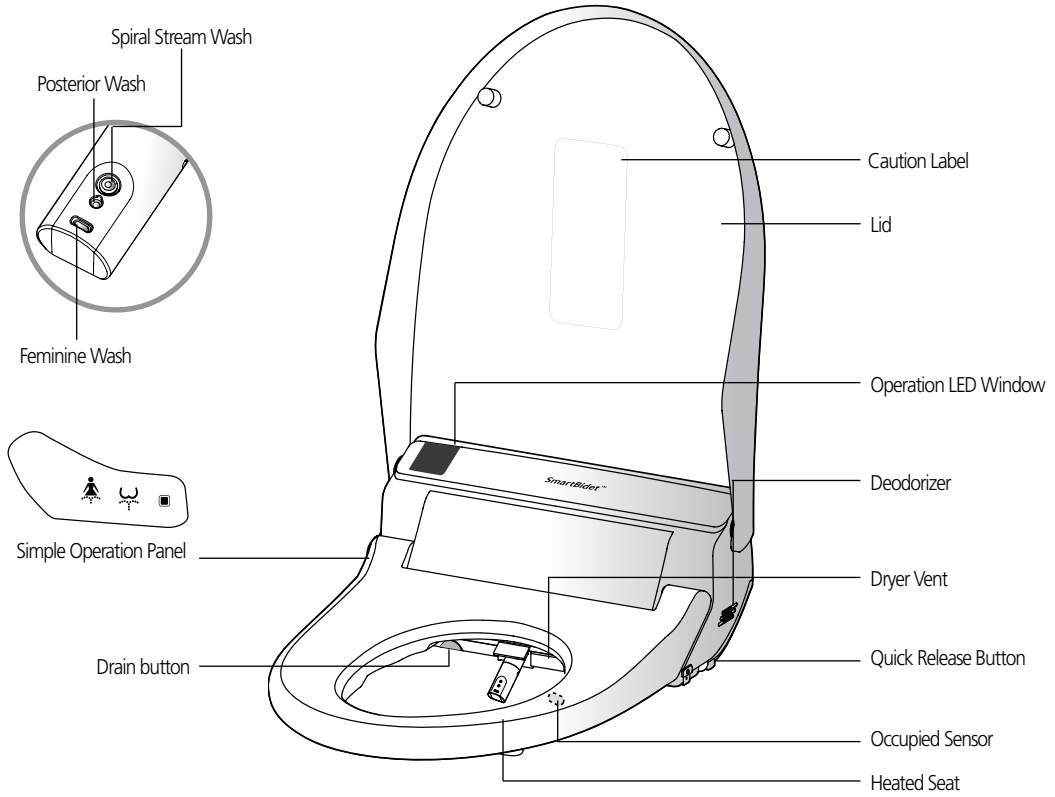

2 ACCESSORIES

For plumbing

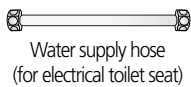
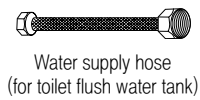
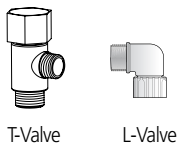

For product fixation

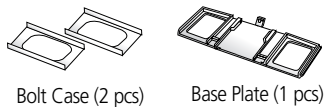
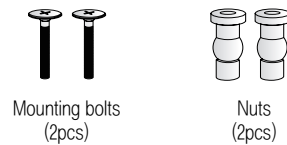

For remote control

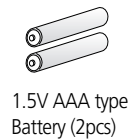
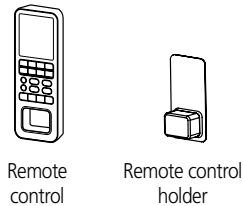

Installation instructions



3 Remote Control

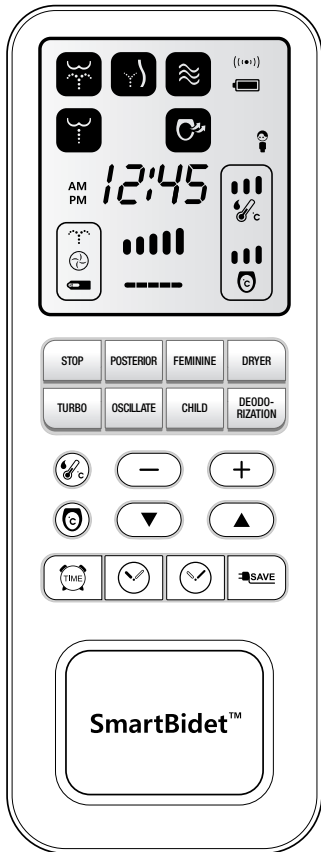

STOP	Stop all operation.
POSTERIOR	Posterior wash.
FEMININE	Feminine wash.
DRYER	Dry washed area.
TURBO	Spiral Stream (Turbo) Wash
OSCILLATE	When selected during wash function nozzle oscillates automatically for a wider wash.
CHILD	The unit will stop after operating the automatic wash for 30 sec then dryer for 1 minute.
DEODORIZATION	When user sits on the seat, it automatically operates to deodorize. (Can select on/off)
Water Temperature Icon	The water temperature can be adjusted up to 4 levels (off, low, middle, high).
Seat Temperature Icon	The seat temperature can be adjusted up to 4 levels (off, low, middle, high).
TIME	Can set time in the remote control with hour (🕒) and minutes (🕒) buttons.
SAVE	If Economy mode is selected, seat temperature and water temperature will stay at 89.6°F.
Battery Icon	If this(🔋) symbol flashes, please change the battery in remote control.

Simple Operation Panel

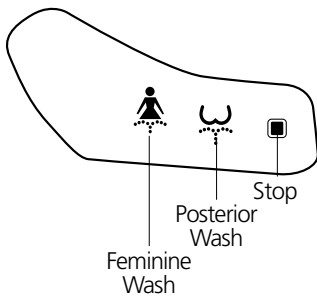

Display



1	Posterior Wash	10	Heated Water
2	Feminine Wash	11	Seat Temperature
3	Dryer	12	Heated Seat
4	Spiral Stream Wash	13	Water Pressure
5	Deodorizer	14	Dryer
6	Remote signal	15	Nozzle Position
7	Battery Life	16	Water Pressure
8	Child Wash & Dry	17	Nozzle Position
9	Water Temperature		

- When you sit down on this product, sit in the center in order to activate the sensor. (If the unit's input water temperature is lower than 54°F (12.2°C), the water temperature could be lower than the above noted temperatures)

4 Operation (Basic)



CAUTION



Please press the "off" or "low" button to reduce the seat temperature after using. Special precautions should be taken for children, those who cannot adjust the temperature, and those who have sensitive skin.

1 Check for any water leaks.

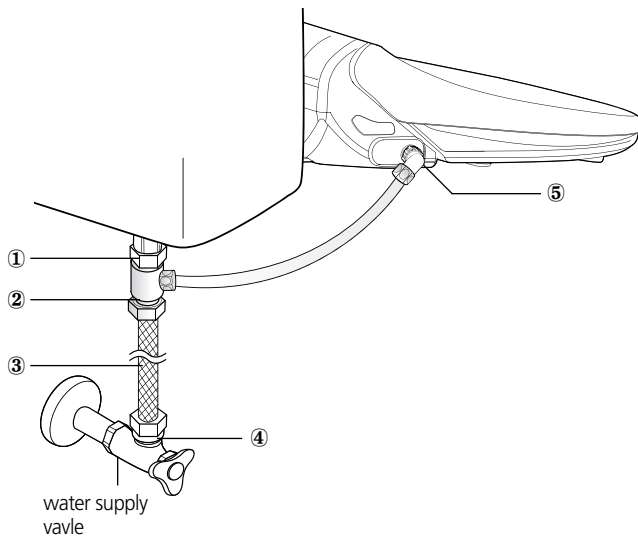
- Please turn on the water supply valve and check connected spots(1~5) for the leakage.



2 PREPARATION

- Please plug the power cord into 120Vac power outlet.
- Plug the unit into the proper power source and the LED power light will start flashing.
- Wait until the LED power light stops flashing and becomes solid red.
- The water tank will be filled after pushing a  or  button.
- When the water tank is filling the buzzer "Beeps" continuously. After the water tank is full, the buzzer will end with "One Solid Beep".



Observe at all times

CAUTION

DO NOT ALLOW CHILDREN TO USE THE **TURBO WASH** or **SPIRAL STREAM WASH** FUNCTION! SUPERVISION IS STRONGLY RECOMMENDED FOR THE ELDERLY OR OTHER PERSONS THAT MAY HAVE LIMITATIONS IN BODY MOVEMENT, ILLNESS OR DISABILITIES!

3 OPERATION

SIT DOWN ON THE SEAT

- When the digital skin sensor on the seat is activated, the operation LED window on the main unit will light "Occupied sensor" and simultaneously, the deodorizer fan will start to work.
- See page 12 for details about changing the seat or water temperature.

STOP

- Press this button to stop all operation.

CLEANSING

• CLEANSING 1. (Posterior Wash)

- 1- Press "Posterior Wash" (). Automatically, the nozzle comes out and sprays warm water to posterior.
- 2- Additional functions during your Posterior Wash experience are available. See Oscillation, page 13

• CLEANSING 2. (Feminine Wash)





- 1- Press "Feminine Wash" (). Automatically, the nozzle comes out and sprays warm water to feminine area.
- 2- Additional functions during your Feminine Wash experience are available. See Oscillation, page 13

• CLEANSING 3. {Spiral Stream (Turbo) Wash}

- 1- Press "Spiral Stream (Turbo)" (), the nozzle spray is more or focused to produce the effect of strong wash, to help stimulate bowel movement.
- 2- Press "Water pressure - High & Low button" to adjust the water pressure.



CLEANSING cont.

• CLEANSING 3. {Spiral Stream (Turbo) wash}



- 1- Press "Spiral Stream (Turbo) wash" Automatically, the water nozzle comes out and sprays a warm stream of water to the posterior center of the rectum.
- 2- If necessary, adjust "Position" of water stream with the ( / ) buttons.
- 3- Press "Water pressure High & Low button" ( / ) to adjust the water pressure to your desired comfort.
- 4- Press the "STOP" button when you feel your abdomen is full or wait until the "Spiral Stream (Turbo) wash" function stops, approximately 1 minute.
- 5- You will shortly feel the urge to push the water out of your colon, push the water and feces out as thoroughly as you can.
- 6- Relax for a few minutes and be sure you feel your colon is empty and then use the "Posterior Wash" and "Dryer" function to finish.

5 Operation (Details)



● WARM AIR DRYER

- 1- Press "Dryer" (), warm dry air will be gently directed to the washed area for about 3 minutes.
 - 2- You may adjust the warm air temperature by pressing High() and Low() buttons.
- ※ This product memorizes the air temperature of prior use.

● WATER PRESSURE ADJUSTMENT

- After sitting down on the this product, the LED lamp for water pressure on the Power Control will light at third or middle level.
- Press high(), or low() to adjust the pressure of the water spray to your desired comfort level.

● WARM WATER TEMPERATURE AND SEAT TEMPERATURE ADJUSTMENT

- The temperature of water and seat are adjustable to the desired level by pressing the "WATER" () and "SEAT" () button.

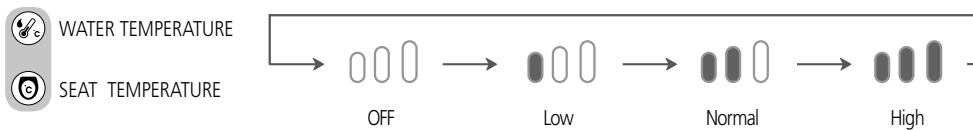

● DEODORIZER

■ Deodorizer ON/Off (initial setting is Off)

- Press button for() press the button again for 3 seconds, the function is canceled.
- After setting Deodorizer function, it is automatically activated when sensing the human body.

DEODO-
RIZATION

On: Press "Deodorization" button
Single Chime





DEODO-
RIZATION

Off: Press "Deodorization" button
Double Chime

- Once used, the Deodorizer function automatically stops after 1 minute of operation.

Reference - Deodorizer function stops while dryer is selected. After dryer function completes, deodorizer automatically is activated.

● OSCILLATION (Nozzle Movement Function)

- When using Posterior or Feminine wash functions, pressing the "OSCILLATE" () button will provide a short-motion, front to back oscillating spray for a much wider cleansing experience.
- You may change the position of the Oscillating spray by pressing the "OSCILLATE" () button again and "Front" () or "Rear" () buttons simultaneously.
- Push the "OSCILLATE" () button again and the oscillation motion will stop automatically.



Auto-Setting of Oscillation Feature

- You can set this function to automatically oscillate whenever the seat is occupied and the Posterior or Feminine washes are in operation.

Step 1: Sit on this product.

Step 2: Press the "OSCILLATE" () button for 3 seconds or until you hear a single Chime.

Step 3: Sit on this product and proceed with Posterior or Feminine Wash.



Note: In the automatic setting, you may still adjust the position of the Oscillating spray by pressing the "Front" () or "Rear" () buttons.

Canceling the Automatic Oscillation function

Step 1: Sit on this product.

Step 2: Press the "OSCILLATE" () button for 3 seconds or until you hear a double Chime.

● NOZZLE POSITION ADJUSTMENT



- Nozzle position is adjustable to the desired position by pressing "Front" () or "Rear" () button from 1 to 5 positions.
After using this product, the nozzle will return to position 3.

● Child Wash and Dry

- When pressing button, the unit will automatically run Posterior Wash 3rd level for 30 seconds then Dryer 3rd level for 1 minute. While using, if you press the stop button, the function will stop.
- This function adjusts nozzle position and dryer temperature for a child's specification.

The recommended minimum child's age to use the bidet seat is 5 years old. We recommend adult supervision while the child is using the unit.

● Power ON/OFF

- When the power is OFF, all of the LED lights will also be turned off and the unit will be turned OFF.
- If you push the  button for 3 seconds, the power will turn OFF after a beep sound.
- To turn the Power back ON, please push the  button.

5 Operation (Details)

● ECONOMY (Energy Save Mode)

■ Saver On/ Off

- When pressing() the energy saver LED on the main unit will turn on. (press button again, the saver LED will turn off)
- Energy saver mode automatically maintains a water and seat temperature of 89.6°F (32°C).
- While the energy saving mode is on, if you increase or decrease the water and seat temperature, the Energy Saving mode will automatically turn off. If you stand up from the bidet seat, the Energy Saving mode will automatically turn back on.

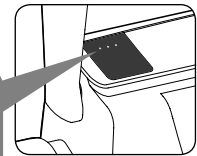
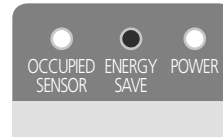

In energy saver mode, the seat heating temperature could appear to be lower than the actual temperature setting.

Other energy saver tips

In order to save energy, please abide by the following instructions:

- Keep seat cover closed when not in use to prevent heat from being lost.
- Keep temperature set to low.
- Unplug the power cord if you do not plan to use the unit for a long period of time.

● Night Light on/off setting

- Press "Stop" and "Temperature" remote buttons simultaneously until night light is turned on or off.



● Nozzle Cleaning (Automatic)

- This product has an automatic nozzle self-cleaning function that cleans the nozzle before and after each wash function.

6 Installation



CAUTION BEFORE INSTALLATION

- This product requires 120V usage.
- Please do not plug in the electrical cord prior to installation.
- Please consult with a licensed electrician if electrical work is needed. In case a grounded outlet is not available, grounding should be done in order to prevent short circuits or electric shock.

STEPS

- 1** Shut water supply by turning it to the right.

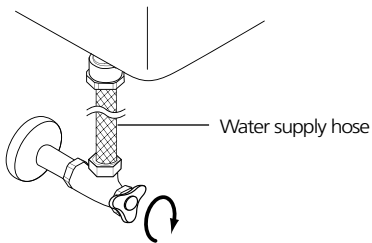

- 2** Disconnect existing hose from water tank. Connect the T-valve to the water tank.

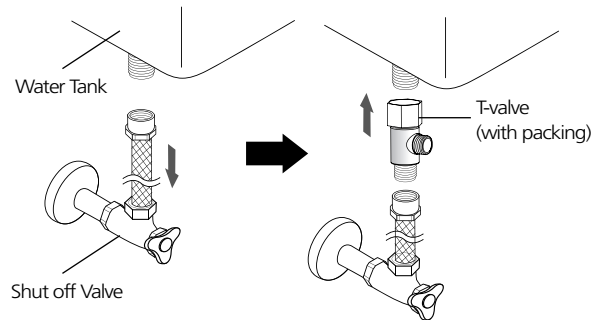

- 3** Connect the water supply hose to the assembled T-valve.

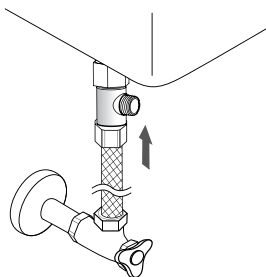

- 4** Remove existing seat and lid.

- Release the bolts on both sides of the existing toilet seat to remove the seat and lid.
- Store the removed seat, nut and water hose in a safe area in case you move or it needs to be reinstalled.

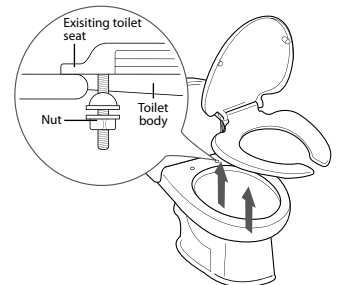

※ Check for any water leaks.

6 Installation

- 5 Put the rubber nuts into the fixing holes of the toilet.

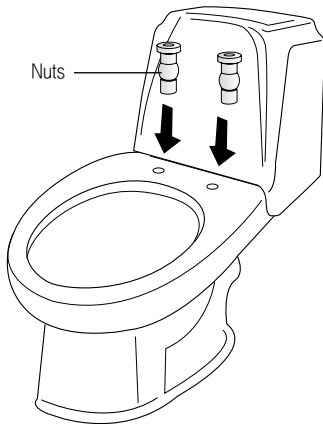

- 6 Put the bolt into the bolt case and align it with the top of the base plate. Insert bolt with bolt case onto the base plate. After this is done, insert it into the rubber nuts with screwdriver.

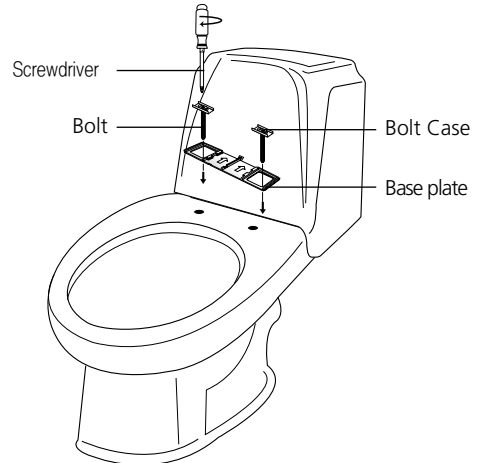

- 7 Push the main unit onto the base plate until hearing "click" sound.

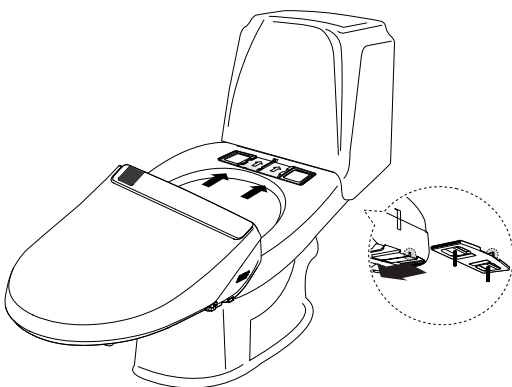

- 8 Connect the flexible tube from the side of the T-valve to the SmartBidet's valve in order to fill the tank with water.

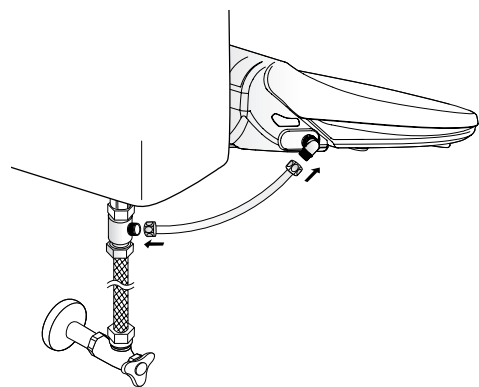

※ Customers should use the new hose set provided with the product. Do not use used set again.

※ Check for any water leaks.

9 Wireless remote mounting guide.

Install wireless remote with adhesive tape

- Remove adhesive from back of the holder and place the holder where desired.

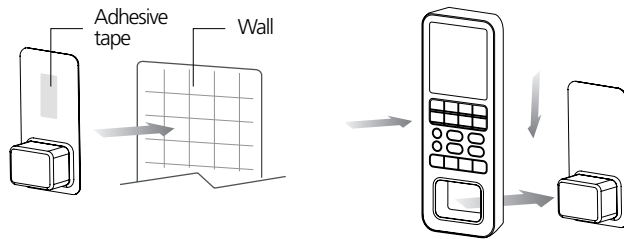

Inserting batteries

- Insert supplied batteries (1.5V AAA) and close battery cover.

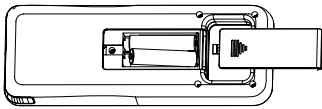

(Please check the polarity, before inserting the batteries.)

7

Water Draining / Separation Of Unit From The Toilet Bowl

Please follow the instructions below when moving or separating the unit from the toilet for cleaning purposes.

- 1 Disconnect the power plug.
- 2 Shut the water supply valve.
- 3 Push and hold the button to the left of the nozzle to completely drain the water from the water tank.
- 4 Loosen the nut on the hose that is connected to the unit, and then separate the electronic toilet seat from the toilet in the following order as illustrated.



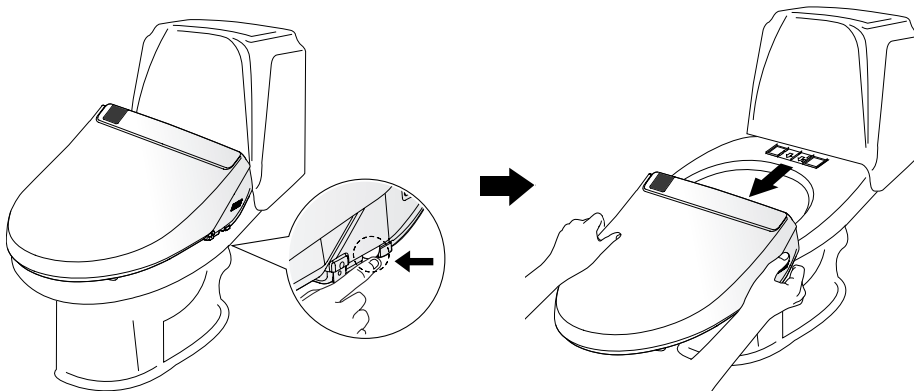

⚠ Do not turn the seat upside-down. This can cause damage to the unit as well as fire hazard.



- While pushing the button (area shown as an arrow) push the electronic toilet seat slightly toward to the front and then the body unit will begin to slide out. Next, lightly pull the unit toward the front and it will detach from the toilet.

- 5 Disconnect the T-valve from the water tank.
- 6 Connect the water hose to the toilet which was disassembled while installing the electronic toilet seat, and turn the water valve to the left to open it. See if there is any leaking from the water hose connection.
- 7 Re-install the toilet seat and lid that was separated when installing the electronic toilet seat.
 - As explained above, steps 1~4 are instructions for separation of the unit for basic cleaning purposes, and steps 5~7 are instructions for separation when moving, etc.

CLEANING THE NOZZLE

- When you press down onto the "Posterior Wash" () button for 3 seconds without occupying the seat, the nozzle will extend. Clean the nozzle with a soft toothbrush.
- After cleaning the nozzle, push the "Stop" () button once again, and the nozzle retracts itself.

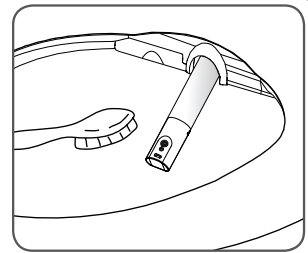

CLEANING THE BODY OF UNIT

- When you clean this product, do not use thinner, benzene or toilet bowl cleaner. It may cause damage to the surface of unit.
- Use a wet cloth when you clean this product.
- Do not spray water directly on to this product.
- When you clean this product, disconnect the power plug.

CLEANING THE STRAINER

This product will not operate properly if the strainer is clogged. Please clean the strainer regularly.

- 1) Close the water shut off valve.
- 2) Flush the toilet to empty the water reservoir.
- 3) Unscrew the water filter nut.
- 4) Clean the strainer with a small brush or water.
- 5) Re-screw the water filter nut.
- 6) Open the water shut off valve.

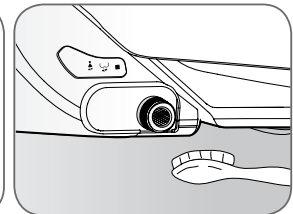
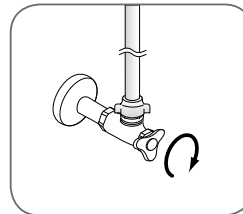

MAINTENANCE FOR WINTER SEASON

- Check if the power cord is plugged in.
- Keep the water temperature on "Middle or High Level" to prevent water from freezing.
- If you do not intend to use the unit for 14 days or longer, disconnect the power plug and drain the water.

Troubleshooting	Problem	Solution
<p>The nozzle does not spray</p>	<ol style="list-style-type: none"> 1. The water tank is not filled. if the water tank is filled, water is supposed to come out when pushing the drain button 2. The water supply valve is closed. 3. Freezing inside the main unit or the water supply pipe 	<ol style="list-style-type: none"> 1. Wait about one minute. 2. Press the desired washing button once again. 3. Open the water supply valve. 4. Heat the room (for about two hours). Operating the unit while parts are frozen will cause a malfunction.
<p>The unit is not operating</p>	<ol style="list-style-type: none"> 1. Disconnected the power cord. 2. The seat is not occupied. 3. The battery of remote controller is exhausted. 	<ol style="list-style-type: none"> 1. Connect the power cord. 2. Check the power supply system in your house. 3. Occupy the seat (The unit has an occupied skin sensor). 4. Replace the battery.
<p>Water is leaking</p>	<ol style="list-style-type: none"> 1. Check the water supply system 	<ol style="list-style-type: none"> 1. If water is leaking from the main unit, call the service center or the place you purchased unit.
<p>The washing water pressure is weak</p>	<ol style="list-style-type: none"> 1. The water pressure level is set to "LOW". 2. The strainer is clogged. 	<ol style="list-style-type: none"> 1. Set the water pressure to "HIGH" 2. Clean the strainer.
<p>The washing water is not warm</p>	<ol style="list-style-type: none"> 1. The water temperature is set to "LOW" 2. Continuous operation has depleted the supply of warm water. 	<ol style="list-style-type: none"> 1. Set the water temperature to "HIGH" 2. Wait about three minutes.
<p>The seat and dryer is not warm</p>	<ol style="list-style-type: none"> 1. Turn Off the energy saver. If it is on, the seat and water temperature are maintained at 86.9°F. 	<ol style="list-style-type: none"> 1. Set the seat & dryer temperature to "HIGH"

10 Specifications

Specification		SB-3000
Power rating		120 V / 60 Hz / 1400 W
Water inlet type	Type	Direct Inlet Flow Type
	Water inlet pressure	0.04 ~ 0.7 4MPa(0.4 ~ 7.5 kgf/cm ²)
Wash device	Posterior	Max. 750cc ± 150cc / min.
	Feminine	Max. 750cc ± 150cc / min.
	Spiral Stream (Turbo) Wash	Max. 750cc ± 150cc / min.
	Water pressure adjustments	5 levels
	Warm water temperature control	Room Temp. ~ Low, Normal, High
	Heater	1340 W
	Safety device	Thermal fuse, Thermal switch, Float switch
Heated seat	Temperature control	Room Temp. ~ Low, Normal, High
	Heater	55 W
	Safety device	Thermal fuse
Warm Air Dryer Device	Warm air control	Room temp ~ 131° F , 5 levels
	Heater	250 W
	Safety device	Thermal fuse, Bimetal
Deodorizer		O
Remote control		O
Inlet water temperature		41 °F ~ 95 °F (5 °C ~ 35 °C)
Ambient temperature		41 °F ~ 104°F (5°C ~ 40°C)
Dimensions		Elongated W : 15.4 inch (392mm) L : 20.9 inch (531mm) H : 5.9 inch (152mm)
Weight (lbs)		10.3 lbs (Packed : 14.3 lbs)
Weight capacity (lbs)		330 lbs

• The design and function of this product could be changed without notice for the improvement of its quality.