

INSIGNIA™

## QUICK SETUP GUIDE

# FlexView Case for 7", 8", and 10" Tablets

This protective case features a locking plate that securely holds your tablet in place, yet allows it to be easily removed. Your tablet will be protected from scratches and other damage with this stylish cover.

## PACKAGE CONTENTS

- Protective case
- *Quick Setup Guide*

## FEATURES

- Simple and universal protection for your tablet
- Durable and convenient
- Adjustable corners to secure your tablet
- Flexible viewing in portrait and landscape modes

Before using your new product, please read these instructions to prevent any damage.

## INSTALLING YOUR TABLET

1 Insert the tablet into the inside corners of the case.

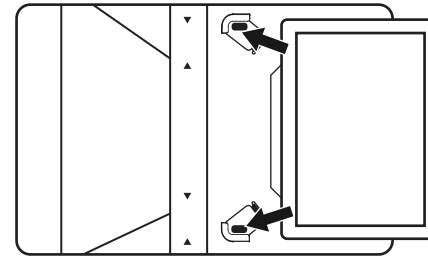

2 Snap the outside corners around the corners of the tablet.

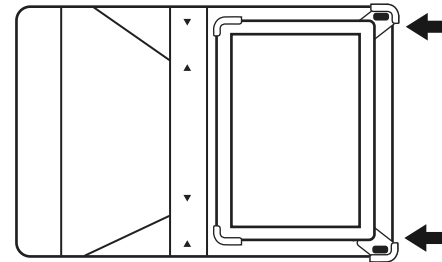

## USING YOUR PROTECTIVE CASE AS A STAND

1 With the cover open and laying flat, lift the inside edge of the tablet mount.

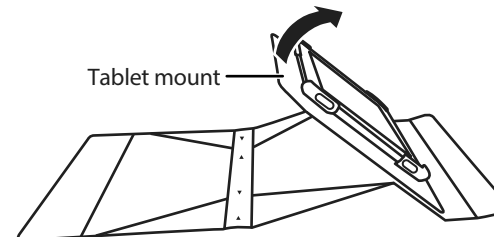



**2** Fold in the right and left edges of the outside of the cover, then attach the outer, magnetic edge of the cover to the top of the tablet mount, forming a rigid stand on the back side of the tablet mount.

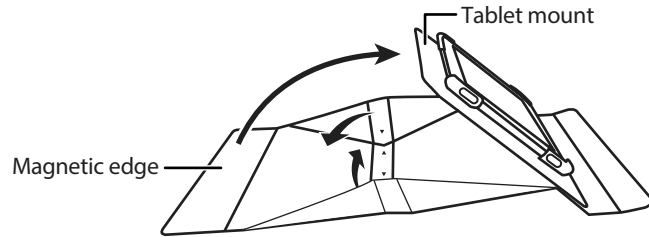

**3** Fold under the bottom edge of the cover.

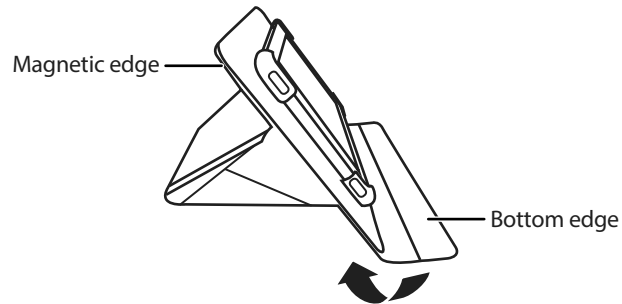

**4** Select your viewing orientation.

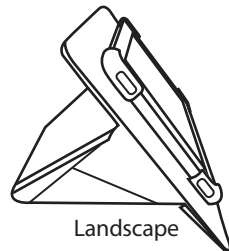

**OR**

Turn the base of the case to select the portrait viewing orientation.

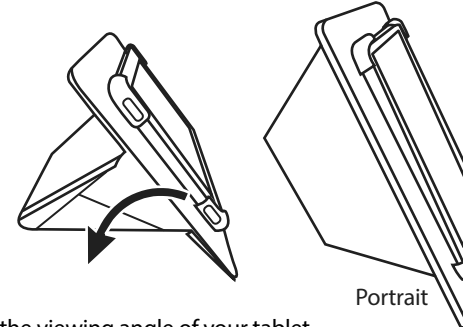

**5** Adjust the viewing angle of your tablet.

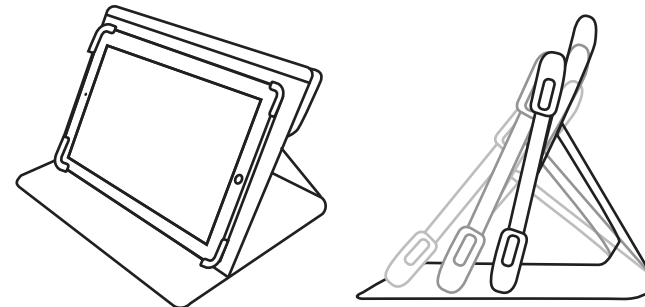

**ONE-YEAR LIMITED WARRANTY**

Visit [www.insigniaproducts.com](http://www.insigniaproducts.com) for details.

**CONTACT INSIGNIA:**

For customer service, call 1-877-467-4289 (U.S. and Canada) or

01-800-926-3000 (Mexico)

[www.insigniaproducts.com](http://www.insigniaproducts.com)

INSIGNIA is a trademark of Best Buy and its affiliated companies. Distributed by Best Buy Purchasing, LLC, 7601 Penn Ave South, Richfield, MN 55423 U.S.A. ©2019 Best Buy. All rights reserved. **Made in China**

