

INSIGNIA™

USER GUIDE

2.0-Channel Mini Soundbar

NS-SB20S

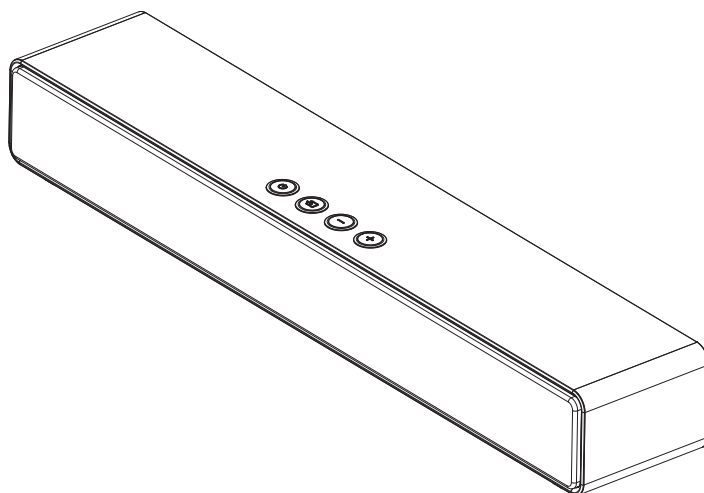

Before using your new product, please read these instructions to prevent any damage.

Contents

Introduction	2
Important Safety Instructions	3
Package contents	6
Features	6
Top view	7
Back view	8
Remote	9
Using the remote	10
Installing the remote batteries	10
Programming another remote	11
Setting up your soundbar	13
Positioning your soundbar	13
Mounting your soundbar on a wall (optional)	14
Choosing your connection	17
Connecting to HDMI ARC (Best)	17
Connecting to digital optical (Better)	18
Connecting to AUX (Good)	19
Connecting to USB	19
Connecting to Bluetooth	20
Using your soundbar	21
Listening to your soundbar	21
Selecting the sound source	22
Changing the volume	22
Selecting a sound mode	22
Using the AUX, OPTICAL, or HDMI ARC sound sources	22
Listening to music from a Bluetooth device	23
Changing the Auto Wake feature	23
Receiving a phone call while playing music	23
Cleaning your soundbar	24
Troubleshooting	24
Specifications	27
Legal notices	28
ONE-YEAR LIMITED WARRANTY	29

Introduction

Congratulations on your purchase of a high-quality Insignia product. Your NS-SB20S represents the state of the art in soundbar design and is designed for reliable and trouble-free performance.

Important Safety Instructions

Read all instructions before use.

Keep these instructions.

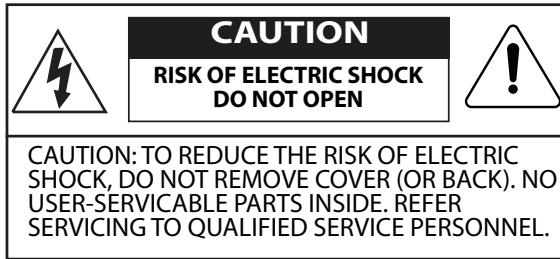

The lightning flash with arrowhead symbol, within an equilateral triangle, is intended to alert the user to the presence of uninsulated “dangerous voltage” within the product’s enclosure that may be of sufficient magnitude as to constitute a risk of electric shock to persons.



The exclamation point within an equilateral triangle is intended to alert the user to the presence of important operating and maintenance (servicing) instructions in the literature accompanying the appliance.

Safety 1.1

- **Read these instructions** – All the safety and operating instructions should be read before this product is operated.
- **Keep these instructions** – The safety and operating instructions should be retained for future reference.
- **Heed all warnings** – All warnings on the appliance and in the operating instructions should be adhered to.
- **Follow all instructions** – All operating and usage instructions should be followed.
- **Do not use this apparatus near water** – The appliance should not be used near water or moisture – for example, in a wet basement or near a swimming pool and the like.
- Clean only with a dry cloth.
- Do not block any ventilation openings. Install in accordance with the manufacturer’s instructions.
- Do not install near any heat sources such as radiators, heaters, stoves, or other apparatus (including amplifiers) that produce heat. Do not place the product in direct sunlight.
- This product is not intended for use by persons (including young children) with reduced physical, sensory or mental capabilities, or lack of experience and knowledge, unless they are supervised or have been given instructions concerning the use of the product by a person who is responsible for their safety.

- Protect the power cord from being walked on or pinched particularly at plugs, convenience receptacles, and the point where they exit from the apparatus.
- Only use attachments/accessories specified by the manufacturer.

Use only with the cart, stand, tripod, bracket or table specified by the manufacturer, or sold with the apparatus.



When a cart or rack is used, use caution when moving the cart/apparatus combination to avoid injury from tip-over.

- Unplug the apparatus during lightning storms or when unused for long periods of time.
- Refer all servicing to qualified personnel. Servicing is required when the apparatus has been damaged in any way, such as power supply cord or plug is damaged, liquid has been spilled or objects have fallen into the apparatus, the unit has been exposed to rain or moisture, does not operate normally, or has been dropped.

 This equipment is a Class II or double insulated electrical appliance. It has been designed in such a way that it does not require a safety connection to electrical earth.

 **WARNING!** Connect to a suitable 100 - 240V~ 50/60Hz power supply only.

- The apparatus shall not be exposed to dripping or splashing. No objects filled with liquids, such as vases, shall be placed on the apparatus.
- Minimum distance around the apparatus for sufficient ventilation is 2 in. (5 cm).
- The ventilation should not be impeded by covering the ventilation openings with items, such as newspapers, table-cloths, and curtains.
- No naked flame sources, such as lighted candles, should be placed on the apparatus.
- Batteries should be recycled or disposed of as per state and local guidelines.
- Use this apparatus in moderate climates.

 **CAUTION:**

- Use of controls or adjustments or performance of procedures other than those described herein, may result in hazardous radiation exposure or other unsafe operation.
- To reduce the risk of fire or electric shock, do not expose this apparatus to rain or moisture. The apparatus must not be exposed to dripping or splashing and objects filled with liquids, such as vases, must not be placed on apparatus.
- The mains plug/appliance coupler is used as the disconnect device, the disconnect device must remain readily operable.

 **WARNING**

- Caution Danger of explosion if battery is incorrectly replaced. Replace only with the same or equivalent type.
- The battery (batteries or battery pack) shall not be exposed to excessive heat such as sunshine, fire, or the like.
- Before operating this system, check the voltage of this system to see if it is identical to the voltage of your local power supply.
- Do not place this unit close to strong magnetic fields.
- Do not place this unit on the amplifier or receiver.
- If any solid object or liquid falls into the system, unplug the system and have it checked by qualified personnel before operating it any further.
- Do not attempt to clean the unit with chemical solvents as this may damage the finish. Use a clean, dry or slightly damp cloth.
- When removing the power plug from the wall outlet, always pull directly on the plug, never yank on the cord.

- Changes or modifications to this unit not expressly approved by the party responsible for compliance will void the user's authority to operate the equipment.
- The rating label is pasted on the bottom or back of the equipment.

**CAUTION: Battery usage**

To prevent battery leakage which may result in bodily injury, property damage, or damage to the apparatus:

- Install all batteries correctly, + and - as marked on the apparatus.
- Do not mix old and new batteries.
- Do not mix alkaline, standard (Carbon-Zinc) or rechargeable (Ni-Cd, Ni-MH, etc.) batteries.
- Remove batteries when the unit is not used for a long time.



Correct Disposal of this product. This marking indicates that this product should not be disposed with other household wastes throughout the EU. To prevent possible harm to the environment or human health from uncontrolled waste disposal, recycle it responsibly to promote the sustainable reuse of material resources. To return your used device, please use the return and collection systems or contact the retailer where the product was purchased. They can take this product for environmental safe recycling.



The Bluetooth® word mark and logos are registered trademarks owned by Bluetooth SIG, Inc. and any use of such marks by Insignia is under license. Other trademarks and trade names are those of their respective owners.



The terms HDMI, HDMI High-Definition Multimedia Interface, HDMI trade dress and the HDMI Logos are trademarks or registered trademarks of HDMI Licensing Administrator, Inc.

Package contents

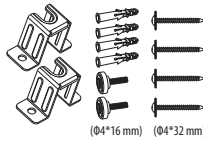
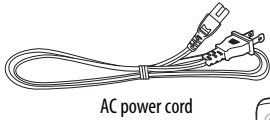
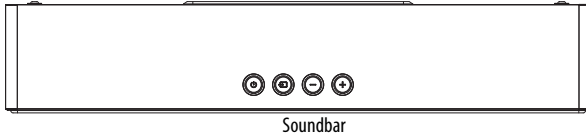

Features

- **Compact Design** - Fill your room with sound, not clutter
- **EQ Customization** - Adjustable bass and treble levels to fine-tune sound

Top view

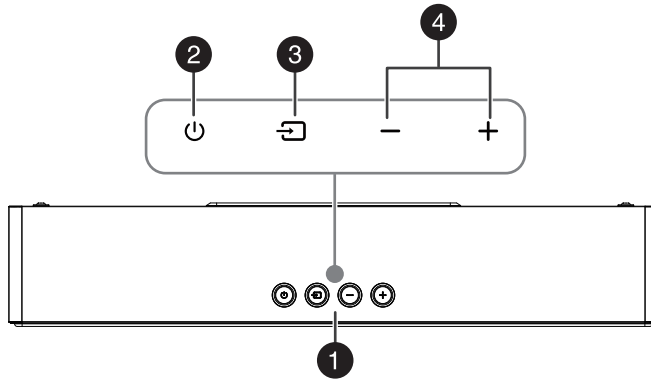

#	ITEM	DESCRIPTION
1	IR sensor and status indicator LED (on the front)	<p>The IR sensor detects signals from the remote. Do not block.</p> <p>The status indicator LED indicates the following:</p> <ul style="list-style-type: none"> • Red - Standby mode • Green - Digital optical mode • Yellow - AUX mode • Blue - BLUETOOTH mode • Purple - USB mode • White - HDMI ARC mode
2	⏻ (power) button	Press to turn your soundbar on or off.
3	⏮ (sound source selector) button	Press to cycle through the available sound sources.
4	- (volume down) button + (volume up) button	<p>Press - to decrease the volume of your soundbar.</p> <p>Press + to increase the volume of your soundbar.</p>

Back view

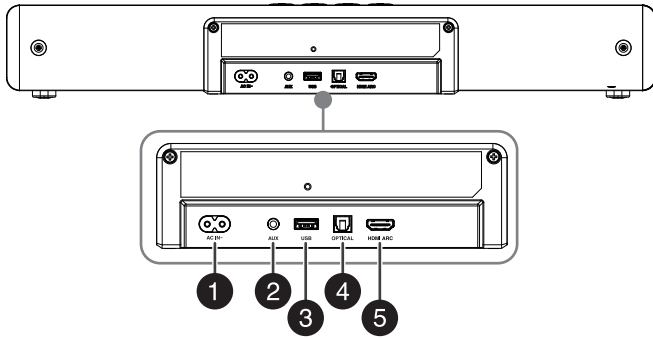



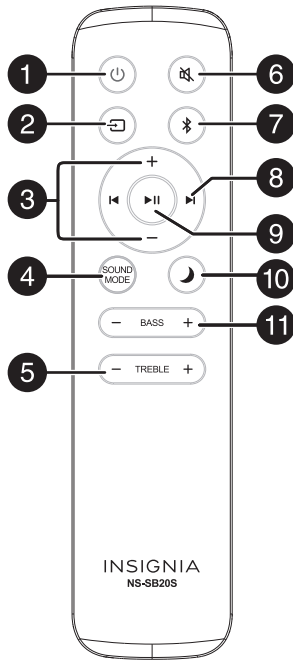

#	ITEM	DESCRIPTION
1	AC IN socket	Connect the AC power cord to this socket to power your soundbar.
2	AUX jack	Connect a 3.5 mm audio cable to this jack.
3	USB port	Connect a USB source device to play MP3/WAV/FLAC files.
4	OPTICAL jack	Connect a digital optical cable to this jack and the OPTICAL OUT jack on a TV or audio source device. Set the sound output from the source to the PCM format.
5	HDMI ARC jack	Connect an HDMI ARC cable to this jack and the HDMI ARC OUT jack on a TV or audio source device, then set the sound output from the source to the PCM format.

Remote



#	ITEM	DESCRIPTION
1	⏻ (power) button	Press to turn your soundbar on or off.
2	📺 (sound source selector) button	Press repeatedly to cycle through the available sound sources.
3	+/- (volume) buttons	Press to increase or decrease your soundbar's volume.
4	SOUND MODE button	The status indicator LED flashes from left to right effect and is accompanied by prompt: <ul style="list-style-type: none"> • STANDARD - General music or TV shows listening. • THEATER - Optimize movie sound for a theater setting. • NEWS - Optimize spoken voice or dialog for TV news and more.
5	TREBLE +/- button	Press to adjust the treble level of your soundbar.
6	🔇 (mute) button	Press to mute or resume the sound. Press and hold for eight seconds to turn on/off voice prompts. Prompts for EQ, Bluetooth pairing, Bluetooth disconnected, and Bluetooth connected are never turned off. <ul style="list-style-type: none"> • On: The green status indicator LED blinks three times quickly (all voice prompts are turned on). • Off: The red status indicator LED blinks three times quickly.

#	ITEM	DESCRIPTION
7	 (Bluetooth) button	Press to select the Bluetooth mode. Press and hold for three seconds to enter Bluetooth pairing mode.
8	 (previous/next) buttons	In Bluetooth or USB mode, press to skip to the previous or next track.
9	 (play/pause) button	In Bluetooth or USB mode, press to play or pause playback.
10	 (NIGHT mode) button	<ul style="list-style-type: none"> • Short press to switch to NIGHT mode, then short press again to return to the sound mode of the previous sound mode. • Press and hold for eight seconds to turn on/off the Auto Wake function. • When Auto Wake is turned off, the middle three white status indicator LEDs will blink three times. • When Auto Wake is turned on, all seven white status indicator LEDs will blink two times.
11	BASS -/+ button	Press to adjust the bass volume level of your soundbar.

Using the remote

Point the remote directly at the IR sensor on the front of your soundbar. You must be within approximately 19.7 ft. (6 m) of your soundbar, with no obstacles between your soundbar and the remote.

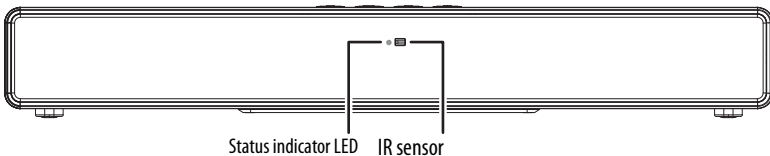

Installing the remote batteries

 CAUTION
<ul style="list-style-type: none"> • Be sure to insert the batteries with correct positive “+” and negative “-” polarities, as indicated in the battery compartment. • Use batteries of the same type. Never use different types of batteries together, and do not mix new batteries with old ones, and do not use any batteries other than those specified. • Either rechargeable or non-rechargeable batteries can be used. Refer to the precautions on their labels. Never recharge a battery unless it is confirmed to be a rechargeable type. • Do not drop the remote. • Do not allow anything to impact the remote. • Do not spill water or any liquid on the remote. • Do not place the remote on a wet object. • Do not place the remote under direct sunlight or near sources of excessive heat. • Remove the battery from the remote when not in use for a long period of time, as corrosion or battery leakage may occur and result in physical injury, and / or property damage, and/or fire.

- 1 Remove the battery compartment cover from the back of the remote.

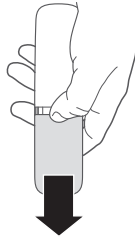

- 2 Insert two AAA batteries into the battery compartment, making sure that the polarities on the batteries matches the + and - symbols inside the battery compartment.

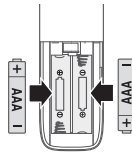

- 3 Replace the battery compartment cover.



Programming another remote

IR remote learning function (optional)

Your soundbar can learn 15 button codes from most remotes, so you can easily control the sound with both the soundbar remote and the TV remote. You can also replace the soundbar remote with another remote.

Programming using the Manual Sequence Learning mode:

- 1 With the power off, press and hold the  (power) button on the top of your soundbar for six seconds to enter the Manual Sequence Learning mode. After entering the learning mode, the middle yellow status indicator LED will blink quickly.
- 2 Press the button on your soundbar remote that you want to learn. After selecting, your soundbar will enter the IR learning state for the current function, and the middle yellow status indicator LED will blink slowly.
- 3 Press the target button on your remote until the 1st and 7th white status indicator LEDs illuminate. During the learning process, the middle yellow status indicator LED will remain on.



- 4 Press the target button on your remote again until the 1st, 2nd, 6th, and 7th white status indicator LEDs illuminate. During the learning process, the middle yellow status indicator LED will remain on.



- 5 Press the target button on your remote again until the 1st, 2nd, 3rd, 5th, 6th, and 7th white status indicator LEDs illuminate, and the middle status indicator LED turns from yellow to green. After the button learning is completed, your soundbar will switch back to the customizable IR learning state, only the middle yellow status indicator LED will blink quickly.

NOTE: If the button is incorrectly pressed for the third time, the middle status indicator LED will blink red twice and the system will revert to Step 4.



- 6 Repeat steps 2-5 to bind the function buttons that you want to learn to the new remote.
- 7 Your soundbar will automatically exit the learning mode if there is no operation for 20 seconds.

OR









Press and hold the  (sound source selector) button on your soundbar for two seconds to exit the learning mode.

OR

After learning 15 buttons, IR learning will automatically stop and exit.

Programming using the Preset Sequence Learning mode:

- 1 Point your soundbar’s remote and the remote you want to program within 4 in. (10 cm) of the IR sensor on your soundbar.
- 2 With the power off, press and hold the  (power) button for three seconds to turn on the Preset Sequence Learning mode. The status indicator LED blinks yellow slowly and your soundbar starts to learn the buttons in the following sequence:

Note: The sequence for programming your soundbar remote buttons must follow this specific order:  (power) >  (mute) >  (sound source selector) >  (Bluetooth) > + (volume up) > - (volume down) >  (previous) >  (next) >  (play/pause) > **SOUND MODE** >  (NIGHT mode) > **BASS +** > **TREBLE -** > **TREBLE +**.

- 3 Press the target button on your remote until the 1st and 7th white status indicator LEDs illuminate. During the learning process, the middle yellow status indicator LED will remain on.



- 4 Press the target button on your remote again until the 1st, 2nd, 6th, and 7th white status indicator LEDs illuminate. During the learning process, the middle yellow status indicator LED will remain on.



- 5 Press the target button on your remote again until the 1st, 2nd, 3rd, 5th, 6th, and 7th white status indicator LEDs illuminate, and the middle status indicator LED turns from yellow to green. After the button learning is completed, it will switch to the next preset button, only the middle yellow status indicator LED will blink slowly.

NOTE: If the button is incorrectly pressed for the third time, the middle status indicator LED will blink red twice and the system will revert to Step 4.



- 6 Repeat steps 3-5 to bind the other buttons in the preset learning mode to the remote that you want to program one by one, or short press the  (sound source selector) button on your soundbar to skip the current button function in the learning sequence.
- 7 Your soundbar automatically exits the learning mode if no buttons are pressed for 20 seconds.

OR

Press and hold the  (sound source selector) button on your soundbar for two seconds to exit the learning mode.

OR

After learning 15 buttons, IR learning will automatically stop and exit.

Deleting all learned remote codes:

With the power off, press and hold the  (power) button on your soundbar for 10 seconds to clear all learned codes. All the white status indicator LEDs blink five times quickly when all the learned remote codes are cleared.



Setting up your soundbar

Positioning your soundbar

- Your soundbar is made out of plastic and is therefore sensitive to extreme temperatures and humidity. Do not put it in locations subject to direct sunlight or in humid places, such as near an air conditioner, humidifier, bathroom, or kitchen.
- Do not put water or other liquids close to your soundbar. If liquid is spilled on top of your soundbar, it may be damaged.

- Your soundbar should be placed on a sturdy, flat surface that is free from vibration, or mounted on a wall. Do not put your soundbar on an uneven or unstable surface, where it may fall and get damaged.

! WARNING

Incorrect installation can result in serious injury or damage to your soundbar. If necessary, seek the assistance of a professional.

Note: If you are installing screws into drywall or concrete, use wall anchors (provided) designed for that type of surface.

- If your TV is placed on a table, you can place your soundbar on the table directly in front of the TV stand, centered with the TV screen.
- If your TV is attached to a wall, you can mount your soundbar on the wall directly below the TV screen.

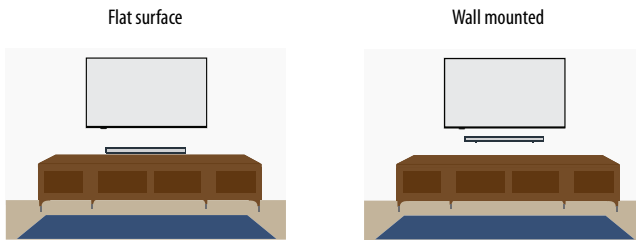

Mounting your soundbar on a wall (optional)

! WARNING

- Improper wall mounting may result in accident, injury or damage. If you have any query, contact Consumer Care in your country.
- Before wall mounting, make sure the wall can support the weight of your soundbar.
- Depending on the type of wall mounting your soundbar, make sure that you use screws of a suitable length and diameter.
- To prevent injury, this apparatus must be securely attached to the wall in accordance with the installation instructions.
- Before attempting to mount the soundbar to a wall, if you are in any way unsure about how or where to mount the soundbar, you should employ a qualified person to install it.

Important:

- Make all connections to your soundbar before mounting your soundbar on a wall.
- The hardware supplied with your soundbar may not be suitable for all types of walls. Please consult a professional for advice before drilling any holes, if you are in any doubt.
- Mark the position on the wall that you want the soundbar to be mounted and check that they align with the holes in the brackets before drilling any holes.
- Suggested wall mounting height: 4.9 ft. (1.5 m).
- Before wall mounting, you don't need remove the rubber feet on the bottom of the soundbar, if you do remove them, they cannot be replaced.
- Please check whether the USB port on the back of your soundbar is connected to a USB device. If you find that the connected USB device affects the wall mount, you need to use another USB device of the appropriate size.

You will need (not provided):

Level



Screwdriver

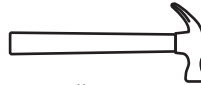

Hammer

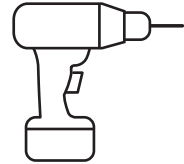

Electric drill and drill bit

Stud finder
(optional for wood stud
installation)

Tape

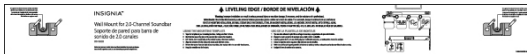

Tape measure

You will need (provided):

Mounting template

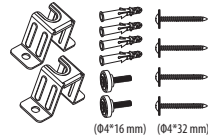

Mounting hardware

- 1 Select a location close to your TV and directly in front of the viewing/listening position. For best sound quality, choose a location where sound waves are not blocked by furniture or other obstacles.
- 2 If you are mounting your soundbar to drywall, use the stud finder to find the studs and mark the locations.

Note: Since normal stud spacing is 16 in. or 24 in. on center, only one of the mounting screws can be in a stud. Use a wall anchor for the other screw.

- 3 Place the template at least 2 in. (5 cm) under the center of the TV. Use a level to determine that the mounting template is level, then tape the mounting template to the wall.
- 4 Using the template, mark the wall where the holes need to be drilled. Do not drill through the template.

- Using an electric drill, drill four parallel $7/32$ in. (5.5 - 6 mm) holes through the markings on the wall. The horizontal distance between the two mounting points on the brackets from your mounting hardware are approximately $17 \frac{47}{64}$ in. (45.05 cm), and the hole distances are $1 \frac{1}{3}$ in. (3.32 cm) apart. Use the template for exact distances.

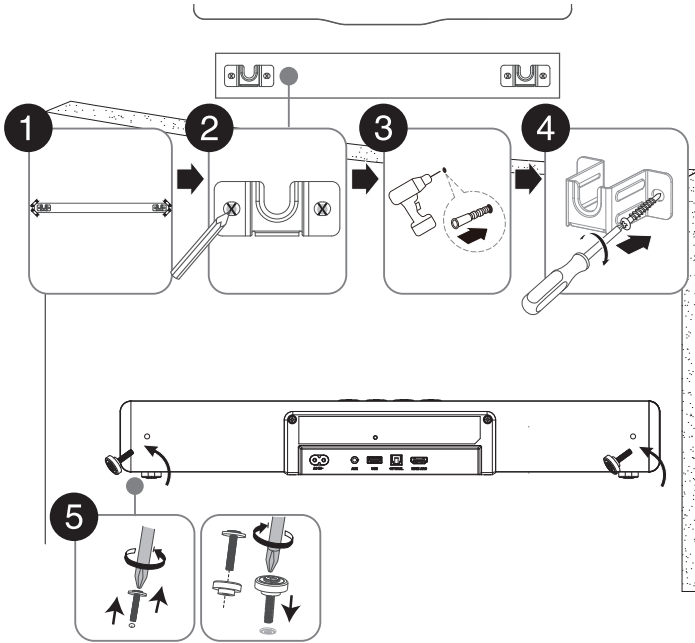

- If you are mounting on drywall without studs or on concrete, install wall anchors (included) into the four holes you drilled.

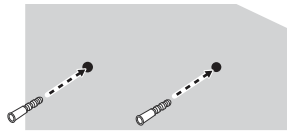

- Secure the mounting brackets to the wall with two screws each (included). Tighten the screws, but do not over tighten.
- Remove the two existing screws from the back of your soundbar and replace with the two wide-head screws from the mounting kit.
- Align the screws on your soundbar with the speaker hanging brackets on the wall, then hang your soundbar on the brackets.

 WARNING
<p>Incorrect installation can result in serious injury or damage to your soundbar. If necessary, seek the assistance of a professional.</p>

Connecting the AC power cord

After you have connected your soundbar to an audio source, you need to connect the AC power cord and plug it in.

CAUTION





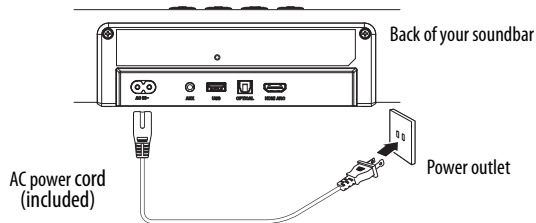

Make sure that the electrical outlet matches the input requirements of 100-240V AC~50/60Hz before connecting.

- Connect one end of the AC power cord (included) into the **AC IN** socket on your soundbar, then plug the AC power cord into a power outlet or surge protector.



Choosing your connection

Look at your sound source device, such as a TV, DVD/Blu-ray player, or cable box, to identify your audio OUT ports. Choose one connection option that fits your sound source. You can connect several devices and switch the sound source as required.

AUDIO QUALITY	JACK TYPE	CABLE
BEST	 HDMI ARC	 HDMI cable (included). See Connecting to HDMI ARC (Best) on page 17.
BETTER		 Digital Optical cable (not included). See Connecting to digital optical (Better) on page 18.
GOOD		 3.5 mm audio cable (not included). See Connecting to AUX (Good) on page 19.

You can also choose a USB flash drive or Bluetooth device as your sound source. See [Connecting to USB](#) on page 19, or [Connecting to Bluetooth](#) on page 20.

Connecting to HDMI ARC (Best)

HDMI ARC allows high definition TV to directly transmit audio to the AV amplifier/receiver through an HDMI cable, without the need for an additional audio cable.

- 1 Remove the caps of the both ends of the HDMI cable (included).
- 2 Connect one end of the HDMI cable (included) to the **HDMI ARC** jack on your soundbar.
- 3 Connect the other end into the HDMI ARC Output jack on your source device.
- 4 Change the source device's audio output to the PCM format (typically found in audio settings).

- 5 Press the  (sound source selector) button on your soundbar or your soundbar remote repeatedly until the status indicator LED turns white.

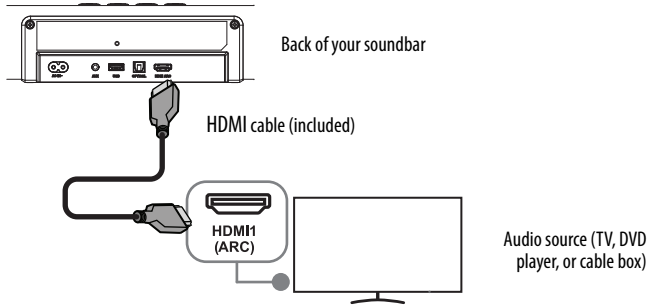

Important: You can use HDMI to connect to other HDMI devices. To use HDMI ARC functionality, the connected device must also have HDMI ARC functionality.

Connecting to digital optical (Better)

- 1 Remove the caps of the both ends of the digital optical cable (not included).
- 2 Connect one end of the digital optical cable (not included) to the **OPTICAL** jack on your soundbar.
- 3 Connect the other end into the Digital Optical Output jack on your source device.
- 4 Change the source device's audio output to the PCM format (typically found in audio settings). See the documentation that came with your audio source device for more information.
- 5 Press the  (sound source selector) button on your soundbar or your soundbar remote repeatedly until the status indicator LED on the front of your soundbar turns green.

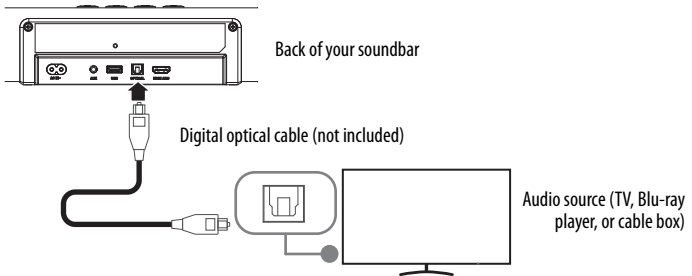

Important: Make sure that the device you connect and select as your sound source is outputting sound to your soundbar. See your device's user manual for more information.

Connecting to AUX (Good)

- 1 Connect one end of the 3.5 mm audio cable (not included) into the **AUX** jack on your soundbar, then connect the other end of the AUX cable to the headphone or AUX Output jack on your audio source device.

Note: You can also use an RCA to 3.5 mm audio cable (also shown).

- 2 Press the  (sound source selector) button on your soundbar or your soundbar remote repeatedly until the status indicator LED on the front of your soundbar turns yellow.

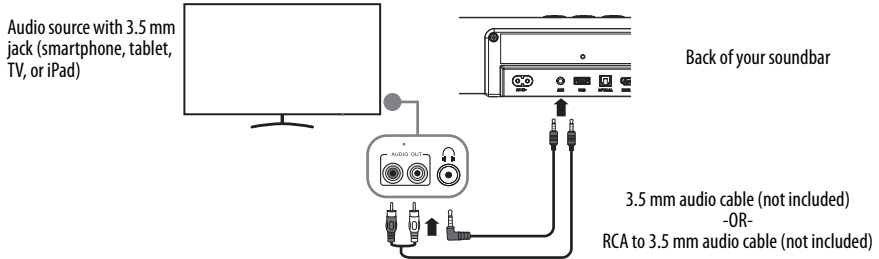

Important: Make sure that the device you connect and select as your sound source is outputting sound to your soundbar. See your device's user manual for more information.

Connecting to USB

- 1 Plug a USB flash drive (with MP3/WAV/FLAC) into the **USB** port on the back of your soundbar.

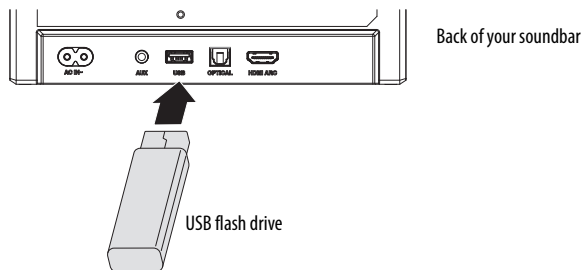

- 2 Press the  (sound source selector) button on your soundbar or your soundbar remote repeatedly until the status indicator LED on the front of your soundbar turns purple.

- Control USB playback by pressing the **▶||** (play/pause) button or the **◀ / ▶** (previous/next) buttons on your soundbar remote.

Notes:

- Your soundbar supports the USB music MP3/WAV/FLAC file format only. When the audio format is not supported, the fourth status indicator LED in the middle will flash red and the remaining status indicator LED will flash white.
- Your soundbar can support USB devices with up to 32 GB of memory.
- Your soundbar may not be compatible with all USB devices, this is not an indication of a problem with your soundbar.

Connecting to Bluetooth

Before you can use your soundbar with a Bluetooth device, you need to pair your device to your soundbar.

Notes:

- Your soundbar must be on to make a Bluetooth connection.
- Place the Bluetooth device within 26.25 ft. (8 m) of your soundbar.

Pairing your devices

- Turn on your soundbar.
- Place your Bluetooth device within 26.25 ft. (8 m) of your soundbar.
- Press the **↔** (sound source selector) button on your soundbar repeatedly until the status indicator LED on the front of your soundbar blinks blue or press the **⌘** (Bluetooth) button your remote.
- Navigate to your device's Bluetooth settings, turn on Bluetooth, then search for available devices. See the documentation that came with your audio source device for more information on pairing.
- On your Bluetooth device, select **Insignia NS-SB20S** from the device list.
- Repeat steps 1-4 if **Insignia NS-SB20S** is not displayed.
- When pairing is completed the status indicator LED on the front of your soundbar lights solid blue. After the BT connection is successful, the blue status indicator LED will be on for three seconds and then turn off.

Tips:

- The operational range between your soundbar and the device is approximately 26.25 ft. (8m).
- Before connecting a Bluetooth device to your soundbar, ensure you know the device's capabilities.
- Compatibility with all Bluetooth devices is not guaranteed.
- Any obstacle between the device and your soundbar can reduce operational range.
- Keep your soundbar away from other electronic devices that may cause interference.
- Your soundbar will also be disconnected when your device is moved beyond the operational range.

Important: Make sure that the device you connect and select as your sound source is outputting sound to your soundbar. See your device's user manual for more information.

Disconnecting your devices

- Turn off the Bluetooth function on your device.
- Press and hold the **⌘** (Bluetooth) button your soundbar remote for three seconds.
- Switch to another function on your soundbar.
- Disable the function from your Bluetooth device.

Reconnecting to a paired device

When your soundbar is not paired to a device, the status indicator LED on the front or your soundbar blinks.

Your soundbar loses the Bluetooth connection if you...	To reconnect...
Turn off your soundbar.	Turn on your soundbar. Your soundbar searches for the last connected Bluetooth device and reconnects.
Move your Bluetooth device out of range.	Move your Bluetooth device within 26.25 ft. (8 m) of your soundbar.
Turn off your Bluetooth device.	Turn on your Bluetooth device, then make sure that Bluetooth is on.
Turn off Bluetooth on your Bluetooth device.	Turn on Bluetooth on your Bluetooth device.
Connect your Bluetooth device to another Bluetooth device.	Disconnect your Bluetooth device from the other Bluetooth device, then set your device to pairing mode. Select Insignia NS-SB20S on your Bluetooth device.

Note: If a device does not automatically reconnect, you may need to reselect **Insignia NS-SB20S** on your Bluetooth device.



Connecting to a different device

- 1 On the Bluetooth device you are currently connected to, turn off the Bluetooth function or unpair your soundbar from your Bluetooth device list. Your soundbar can now be connected to another Bluetooth device.
- 2 Follow the section [Connecting to Bluetooth](#) on page 20 to connect a new device.

Using your soundbar

This system lets you access five different sound sources, including OPTICAL, AUX, Bluetooth, USB, and HDMI ARC.

Listening to your soundbar

- 1 Press the  (power) button to turn on your soundbar. The status indicator LED on the front of your soundbar turns from red to the color of the selected sound source (white=HDMI ARC, green=OPTICAL, yellow=AUX, purple=USB, or blue=Bluetooth).
- 2 Turn on the audio source device connected to your soundbar and begin playback.
- 3 Press the  (sound source selector) button on your soundbar or your soundbar remote repeatedly until you hear sound from your soundbar.

Notes:



- If you use the **HDMI ARC/OPTICAL** jack, you must change your device's audio output setting to the PCM format. See the documentation that came with the output device for additional information. When the audio format is not supported, the fourth status indicator LED in the middle will flash red and the remaining status indicator LED will flash white.
- Make sure that your sound source is set to output sound to your soundbar (whichever connection method you choose). See the documentation that came with the device for additional information.
- To turn your soundbar off completely, you must unplug the AC power cord.

- Adjust the volume on your soundbar or the source audio device to a comfortable level.

 WARNING
Continuous use of high volume sound may permanently damage your hearing.

- Press the  (power) button again to turn off your soundbar. The status indicator LED lights red.

Selecting the sound source

Press the  (sound source selector) button repeatedly on your soundbar or the  (sound source selector) or  (Bluetooth) button on your soundbar remote to select the desired sound source.

The status indicator LED on the front of you soundbar will indicate which mode is currently in use by the colored status indicator LED.

STATUS INDICATOR LED	MODE
Red	Standby
White	HDMI ARC
Green	Optical
Yellow	AUX
Purple	USB
Blue	Bluetooth

Changing the volume

Press the + or - (volume) buttons on your soundbar or on your soundbar remote to adjust the volume. If you wish to turn the sound off, press the  (mute) button on the remote.

- Press the  (mute) button again or press the + (volume up) button on your soundbar or on your soundbar remote to resume normal listening.

Selecting a sound mode

- While audio is playing, press the **SOUND MODE** button on the remote to select desired preset sound modes, either **STANDARD**, **THEATER**, or **NEWS**.
- Press the  (NIGHT mode) button on your soundbar remote to turn NIGHT mode on or off.

Using the AUX, OPTICAL, or HDMI ARC sound sources

- Make sure that your soundbar is connected to a TV or audio device.
- While your soundbar is on, press the  (sound source selector) button repeatedly on your soundbar or on your soundbar remote to select the HDMI ARC, OPTICAL, or AUX sound sources.
- Operate your audio device directly for playback features.

- 4 Press the + or - (volume) buttons to adjust the volume to your desired level.

Tips:

- While in HDMI ARC or OPTICAL mode, if there's no sound output from your soundbar and the HDMI ARC or OPTICAL status indicator LEDs flash quickly, you may need to activate PCM signal output on your source device (for example, TV or DVD player).
- When the audio format is not supported, the fourth status indicator LED in the middle will flash red and the remaining status indicator LED will flash white.

Listening to music from a Bluetooth device

If the connected Bluetooth device supports Advanced Audio Distribution Profile (A2DP), you can listen to the music stored on the device through your soundbar. In addition, if the device also supports Audio Video Remote Control Profile (AVRCP), you can use your soundbar's remote to play music stored on the device.

- 1 Pair your device with your soundbar.
- 2 Play music via your device (if it supports A2DP).
- 3 Use your soundbar remote to control play (if it supports AVRCP).
 - To pause/resume play, press the ►|| (play/pause) button.
 - To skip to a track, press the ◀ / ▶ (previous/next) buttons.

Notes:

- The operational range between your soundbar and the device is approximately 26.25 ft. (8 m).
- Before connecting a Bluetooth device to your soundbar, make sure that you know the device's capabilities.
- Compatibility with all Bluetooth devices is not guaranteed.
- Any obstacle between the device and your soundbar can reduce operational range.
- Keep this soundbar away from other electronic devices that may cause interference.
- Your soundbar will also be disconnected when your Bluetooth device is moved beyond the operational range.

Changing the Auto Wake feature

Auto Wake is enabled by default. With Auto Wake on, if a TV or an external audio device is connected (in HDMI ARC/OPT/AUX mode), your soundbar will switch on automatically when a signal is received from the external device. To change the Auto Wake feature:

- Press and hold the ☾ (NIGHT mode) button on your soundbar remote for eight seconds to turn the Auto Wake feature on or off.
- When Auto Wake is turned off - the middle three white status indicator LEDs will blink three times.
- When Auto Wake is turned on - all seven white status indicator LEDs will blink twice.
- The Auto Wake function for OPT/AUX modes will be temporarily disabled if your soundbar is manually put into standby mode.
- With Auto Wake off, external signals will not switch HDMI ARC/OPT/AUX on automatically.

Receiving a phone call while playing music

- When you receive a call while playing music through your phone, the music stops automatically.
- When you hang up, depending on the setting of your phone, the current track may resume playback.

Cleaning your soundbar



 **CAUTION**

Only use a dry, soft, clean rag to clean the outside of your soundbar. Never clean it with chemicals, detergents, or abrasives.

Troubleshooting

Check this list for a possible troubleshooting solution before calling for service.

PROBLEM	POSSIBLE SOLUTION
The power doesn't come on.	Make sure that the AC power cord is securely plugged into the power outlet and your soundbar.
	Make sure that your soundbar is turned on. It doesn't turn on automatically when you turn on your TV or other sound source.
The remote doesn't work.	Remove any obstacles between the remote and the IR sensor on your soundbar.
	The remote batteries may be exhausted. Replace them.
	Move closer to your soundbar. The remote is only effective to approximately 19.7 ft. (6 m) from your soundbar.
My TV remote doesn't control my soundbar.	Make sure that your soundbar has learned your TV remote's button codes. See Programming another remote on page 11 for instructions for setup.
The sound is breaking up or buzzing.	Make sure that you are connected to an audio out jack on your sound source. The jack doesn't send audio out if it is an input jack.
	Make sure that all connections are secure and cables are not broken or damaged.
	If you're using the HDMI ARC/OPTICAL jack, make sure that the source device's audio source is set to the PCM format. See the documentation that came with the audio source device (such as a TV or DVD player) for additional information.
	Connect to a different source device (such as a TV or DVD player) to see if the buzzing still occurs. If it doesn't, this may indicate an issue with the original source device.
	Use a different connection method (for example, try the HDMI ARC/OPTICAL jack instead of the AUX jack) between your soundbar and the source device to make sure that the jacks on both devices are still working.
	Make sure that the audio cable you're using is not damaged or broken. Try using another one.

PROBLEM	POSSIBLE SOLUTION
There is no sound or very low sound.	Make sure that you're connected to an audio out jack on your sound source. The jack doesn't send audio out if it is an input jack.
	Make sure that the volume level of your soundbar is set to an adequate level.
	If you're using Bluetooth, turn up the volume on your Bluetooth device.
	If you're using Bluetooth, make sure that your Bluetooth device isn't paired with another device.
	Make sure that the volume level isn't muted. Press the  (mute) button on the your soundbar remote to restore the sound output.
	Make sure that the correct audio source is selected. Press the  (sound source selector) button on your soundbar or your soundbar remote repeatedly to switch to the correct audio source.
	Make sure that the power is on and all connections are secure.
	Make sure that the volume is turned up on your sound source.
	If you are using the HDMI ARC/OPTICAL jack, make sure that the source device's audio source is set to the PCM format. See the documentation that came with the audio source device (such as a TV or DVD player) for additional information.
	Make sure that the audio cable you're using isn't damaged or broken. Try using another one.
	Make sure that the sound source device is outputting sound to your soundbar.
There is no sound or low volume in Bluetooth mode.	Make sure that your Bluetooth device is turned on, Bluetooth is turned on, and Insignia NS-SB20S is selected.
	Turn up the volume on your soundbar.
	Turn up the volume on your Bluetooth device.
	Make sure that your Bluetooth device is not muted.
	Make sure that you're playing music from your Bluetooth device.
	Make sure that you have selected the Bluetooth source on your soundbar.
	Make sure that your Bluetooth device is not paired to a different Bluetooth speaker or other device.

PROBLEM	POSSIBLE SOLUTION
My soundbar won't connect to my Bluetooth device.	Shorten the distance between your soundbar and your Bluetooth device.
	Turn your devices off, then on. Re-pair your soundbar and your Bluetooth device.
	Make sure that your soundbar isn't paired to another Bluetooth device.
	Make sure that your soundbar and Bluetooth device are both in pairing mode.
	Make sure that you have selected Insignia NS-SB20S on your Bluetooth device.
My Bluetooth device keeps unpairing.	Shorten the distance between your soundbar and your Bluetooth device.
	If the battery on your Bluetooth device is low, recharge the battery.
Insignia NS-SB20S doesn't appear on my Bluetooth device.	Shorten the distance between your soundbar and your Bluetooth device.
	Put your soundbar into pairing mode, then refresh your list of Bluetooth devices. For more information, see the documentation that came with your Bluetooth device.
	Make sure that your Bluetooth device is visible to other devices. For more information, see the documentation that came with your Bluetooth device.
The sound is lagging or I hear an echo.	Turn off or mute the internal speakers of your TV. See your TV's User Guide for instructions.
My soundbar turns off automatically after 15 minutes.	When there is no signal input for 15 minutes, it will automatically enter standby mode.

Specifications

Designs and specifications are subject to change without notice.

Power requirement	100/240V~50/60Hz
Audio input sensitivity	450mV
Frequency response	85Hz~15kHz
Speaker impedance	8 ohms.
Dimensions (approx.) (H x W x D)	2 7/8 x 19 11/16 x 3 3/4 in. (7.2 x 50 x 9.5 cm)
Weight	Net: 3.72 lbs. (1.69 kg)
Batteries (remote)	AAA (2)
Working environment	Temperature - 32~104° F (0~40° C) Humidity - 5%~90%
Inputs	HDMI ARC jack USB port AUX IN audio jack Digital optical audio jack Bluetooth
USB feature	5V --- 500mA

Legal notices

FCC compliance statement

This device complies with part 15 of the FCC Rules. Operation is subject to the following two conditions: (1) This device may not cause harmful interference, and (2) this device must accept any interference received, including interference that may cause undesired operation.

Note: This equipment has been tested and found to comply with the limits for a Class B digital device, pursuant to part 15 of the FCC Rules. These limits are designed to provide reasonable protection against harmful interference in a residential installation.

This equipment generates, uses, and can radiate radio frequency energy and, if not installed and used in accordance with the instructions, may cause harmful interference to radio communications. However, there is no guarantee that interference will not occur in a particular installation. If this equipment does cause harmful interference to radio or television reception, which can be determined by turning the equipment off and on, the user is encouraged to try to correct the interference by one or more of the following measures:

- Reorient or relocate the receiving antenna.
- Increase the separation between the equipment and receiver.
- Connect the equipment into an outlet on a circuit different from that to which the receiver is connected.
- It is recommended that a dealer or an experienced radio/TV technician be contacted for help.

Changes or modifications not expressly approved by the party responsible for compliance could void the user's authority to operate the equipment.

This equipment complies with FCC radiation exposure limits set forth for an uncontrolled environment.

This equipment should be installed and operated with minimum distance of 20 cm between the radiator and your body. This transmitter must not be co-located or operating in conjunction with any other antenna or transmitter.

ONE-YEAR LIMITED WARRANTY

Best Buy, or its Authorized Partner of Insignia branded products, warrants to you, the original purchaser of this new Insignia branded product ("Product"), that the Product shall be free of defects in the original manufacture of the material or workmanship for a period of one (1) year from the date of your purchase of the Product or the date of delivery (if later than the date of purchase) ("Warranty Period").

For this warranty to apply, your Product must be (i) purchased in the United States or Canada from a Best Buy branded retail store, online at www.bestbuy.com or www.bestbuy.ca, or from Best Buy's Authorized Partner, and (ii) packaged or sold with this warranty statement.

The term "Best Buy", as used in this warranty, refers to Best Buy branded retail stores, www.bestbuy.com, www.bestbuy.ca, and Best Buy's Authorized Partner.

Because Insignia cannot control the quality of products sold by unauthorized sellers, this warranty applies only to Products that were purchased from Best Buy or an Insignia Authorized Partner, unless otherwise prohibited by law. Insignia reserves the right to reject warranty claims for Products purchased from unauthorized sellers, including unauthorized websites.

REPAIR OR REPLACEMENT, AS PROVIDED UNDER THIS WARRANTY, IS YOUR EXCLUSIVE REMEDY FOR BREACH OF WARRANTY. INSIGNIA SHALL NOT BE LIABLE FOR ANY INCIDENTAL OR CONSEQUENTIAL DAMAGES FOR THE BREACH OF ANY EXPRESSED OR IMPLIED WARRANTY ON THIS PRODUCT, INCLUDING, BUT NOT LIMITED TO, LOST DATA, LOSS OF USE OF YOUR PRODUCT, LOST BUSINESS, OR LOST PROFITS. INSIGNIA PRODUCTS MAKES NO OTHER EXPRESS WARRANTIES WITH RESPECT TO THE PRODUCT. ALL EXPRESSED AND IMPLIED WARRANTIES FOR THE PRODUCT, INCLUDING BUT NOT LIMITED TO ANY IMPLIED WARRANTIES OF AND CONDITIONS OF MERCHANTABILITY AND FITNESS FOR A PARTICULAR PURPOSE, ARE LIMITED IN DURATION TO THE WARRANTY PERIOD SET FORTH ABOVE AND NO WARRANTIES, WHETHER EXPRESSED OR IMPLIED, WILL APPLY AFTER THE WARRANTY PERIOD. SOME STATES, PROVINCES, AND JURISDICTIONS DO NOT ALLOW LIMITATIONS ON (i) HOW LONG AN IMPLIED WARRANTY LASTS, (ii) EXCLUSION OR LIMITATION OF INCIDENTAL OR CONSEQUENTIAL DAMAGES, or (iii) LIMITATION OF INCIDENTAL OR CONSEQUENTIAL DAMAGES, SO THE ABOVE LIMITATIONS OR EXCLUSIONS MAY NOT APPLY TO YOU. THIS WARRANTY GIVES YOU SPECIFIC LEGAL RIGHTS, AND YOU MAY ALSO HAVE OTHER RIGHTS, WHICH VARY FROM STATE TO STATE OR PROVINCE TO PROVINCE.

How long does the coverage last?

The Warranty Period lasts for 1 year (365 days) from the date you purchased the Product or the date of delivery (if later than the date of purchase). Your purchase date is printed on the receipt you received with the Product. In the event that Authorized Partner ceases to sell the covered Insignia branded product, this warranty shall terminate for that product and there shall be no repair or replacement of the Product.

What does this warranty cover?

During the Warranty Period, if the original manufacture of the material or workmanship of the Product is determined to be defective by an authorized Insignia repair center or store personnel, Insignia will (at its sole option): (1) repair the Product with new or rebuilt parts; or (2) replace the Product at no charge with new or rebuilt comparable products or parts. Products and parts replaced under this warranty become the property of Insignia and are not returned to you. If service of Products or parts are required after the Warranty Period expires, you must pay all labor and parts charges. This warranty lasts as long as you own your Insignia Product during the Warranty Period. Warranty coverage terminates if you sell or otherwise transfer the Product.

How to obtain warranty service?

If you purchased the Product at a Best Buy retail store location or from a Best Buy online website (www.bestbuy.com or www.bestbuy.ca), please take your original receipt and the Product to any Best Buy store. Make sure that you place the Product in its original packaging or packaging that provides the same amount of protection as the original packaging. If you purchased your Product from an Authorized Partner, call Insignia at 1-877-467-4289.

To obtain warranty service, in the United States and Canada call 1-877-467-4289. Call agents may diagnose and correct the issue over the phone.

If you purchased the Product from an Authorized Partner other than Best Buy, please call 1-888-BESTBUY in the United States or 1-866-BESTBUY in Canada. You will be asked to provide proof of purchase and to return your Product to Best Buy. Make sure that you put the Product in its original packaging or packaging that provides the same amount of protection as the original packaging.

Where is the warranty valid?

This warranty is valid only in the United States and Canada to the original purchaser of the product from an Authorized Partner, in the country where the original purchase was made.

What does the warranty not cover?

This warranty does not cover:

- Food, beverage, and or medicine loss/spoilage.
- Damage to other products caused by a power surge or other similar issue while connected to the Product.
- Customer instruction/education.
- Installation.
- Set up adjustments.
- Cosmetic damage.
- Damage due to weather, lightning, and other acts of God, such as power surges.
- Accidental damage.
- Misuse.
- Abuse.
- Negligence.
- Commercial purposes/use, including but not limited to use in a place of business or in communal areas of a multiple dwelling condominium or apartment complex, or otherwise used in a place of other than a private home.
- Modification of any part of the Product, including the antenna.
- Display panel damaged by static (non-moving) images applied for lengthy periods (burn-in).
- Damage due to incorrect operation or maintenance.
- Connection to an incorrect voltage or power supply.
- Damage due to attempted repair by any person not authorized by Insignia to service the Product.
- Products sold "as is" or "with all faults".
- Consumables, including but not limited to batteries (i.e. AA, AAA, C etc.).
- Products where the factory applied serial number has been altered or removed.
- Loss or Theft of this product or any part of the product.
- Display panels containing up to three (3) pixel failures (dots that are dark or incorrectly illuminated) grouped in an area smaller than one tenth (1/10) of the display size or up to five (5) pixel failures throughout the display. (Pixel based displays may contain a limited number of pixels that may not function normally.).
- Failures or Damage caused by any contact including but not limited to liquids, gels or pastes.

Contact Insignia:

1-877-467-4289

www.insigniaproducts.com

INSIGNIA is a trademark of Best Buy and its affiliated companies.

*Distributed by Best Buy Purchasing, LLC

7601 Penn Ave South, Richfield, MN 55423 U.S.A.

©2025 Best Buy. All rights reserved.

INSIGNIA™

www.insigniaproducts.com

1-877-467-4289 (U.S. and Canada)

INSIGNIA is a trademark of Best Buy and its affiliated companies.

Distributed by Best Buy Purchasing, LLC

7601 Penn Ave South, Richfield, MN 55423 U.S.A.

©2025 Best Buy. All rights reserved.

V1 ENGLISH
25-0161