

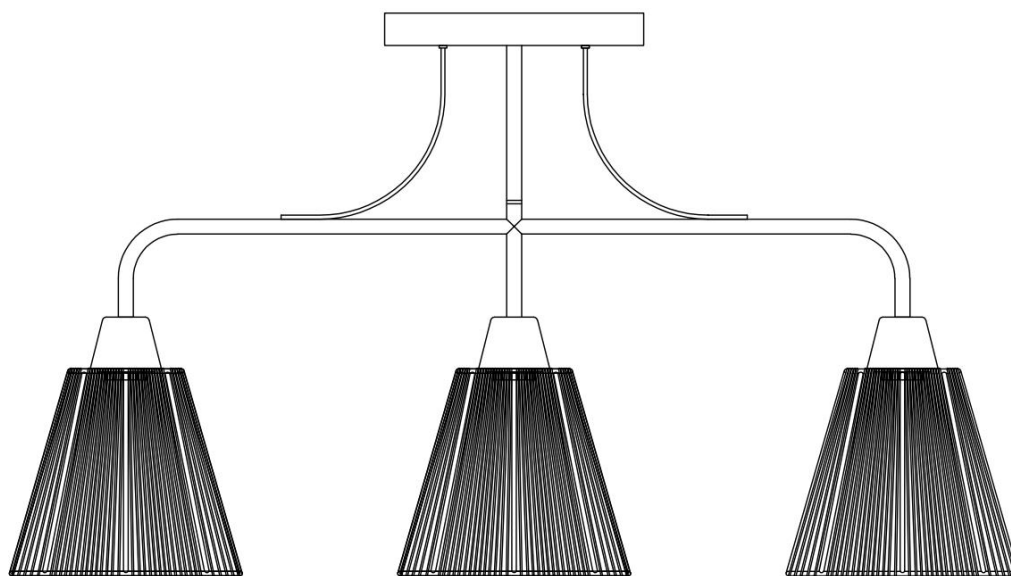

Parrot Uncle

# C5001



English / Español / Français

[www.parrotuncle.com](http://www.parrotuncle.com)

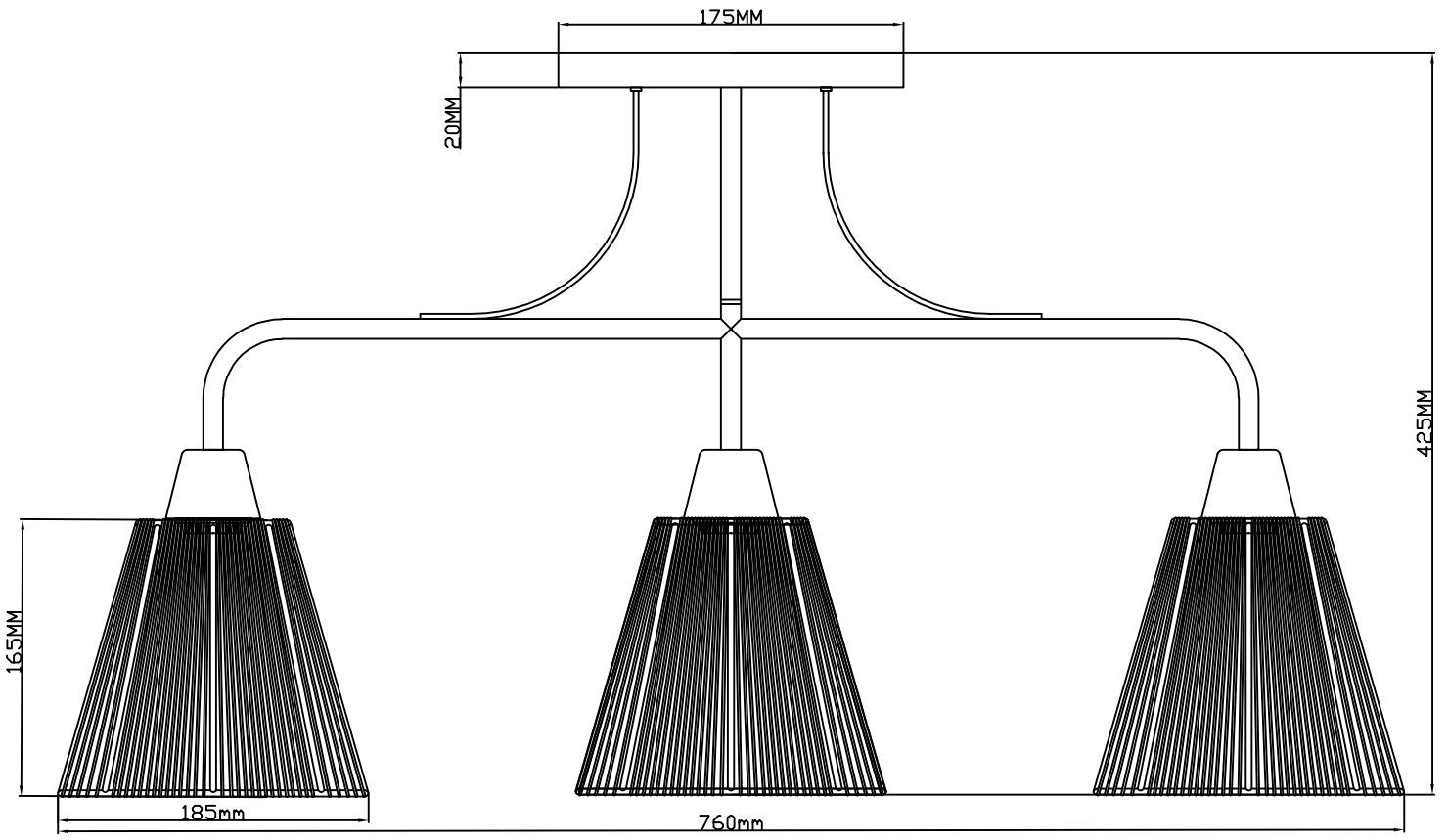

# C5001

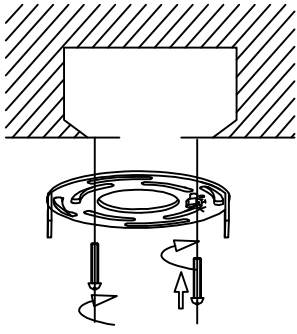

①

Install the bracket on top of the box

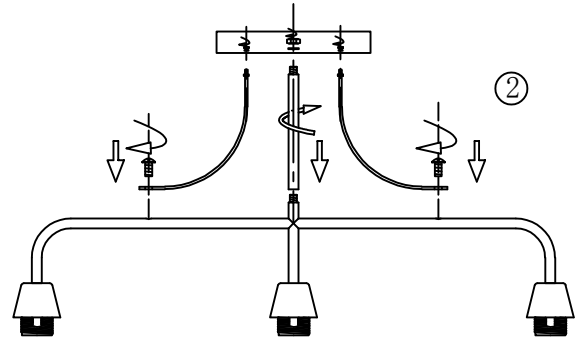

②

Assembly of lamps and lanterns

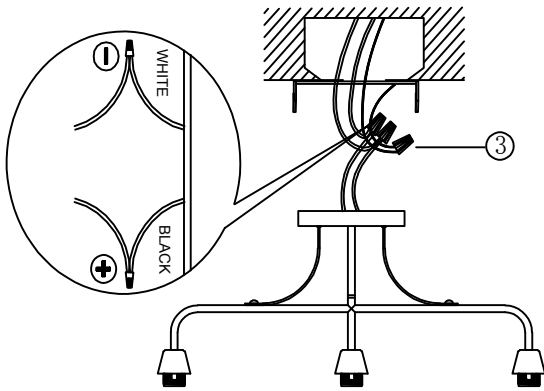

The black line is: L  
The white line is: N  
The yellow and green lines  
are: grounding wires

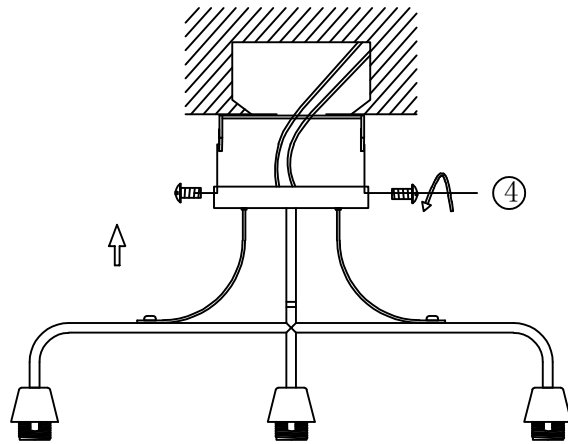

④

Screw the screw into the  
mounting board, and secure  
the light to the mounting  
board.

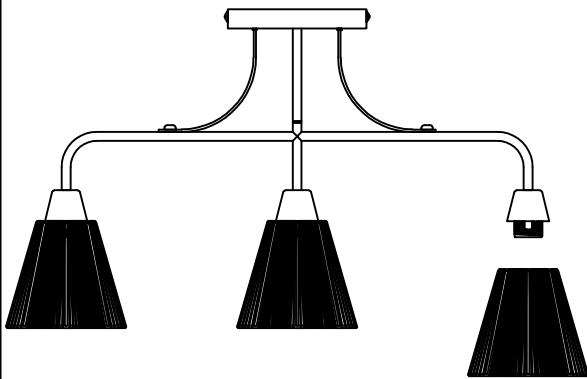

Install the lamp cap ring

⑤

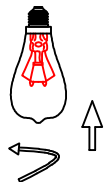
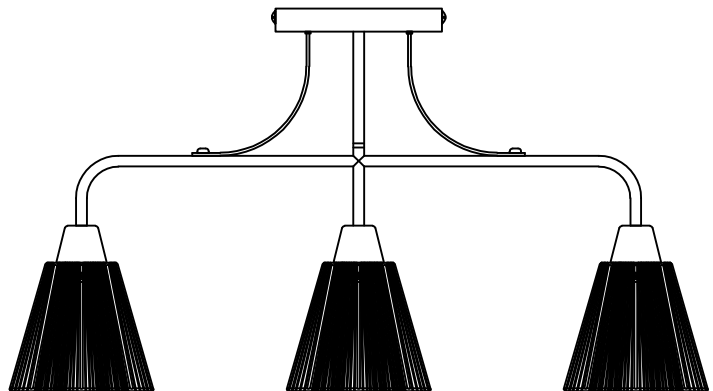

⑥

Installing bulb



**Parrot Uncle**

MADE IN CHINA