



N-GEN

NEXUS Series

USER GUIDE & ASSEMBLY INSTRUCTIONS

Thank you for choosing us!

N-GEN, Next Generation, is Neo Chair's premium gaming chair brand targeting a higher level gaming chair than any other brands.

When pronounced, N-GEN is similar to the word engine [ˈendʒɪn]. Like the engine to a car, N-GEN gaming chair is the most important part for gamers who sit in the chair for a long time.

N-GEN's model names are inspired by the Latin words for "speed".

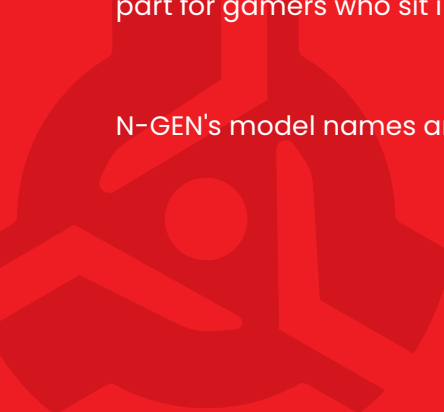

IT'S TIME TO UPGRADE YOUR CHAIR!



CHAIR PARTS

If you see any missing part, please contact support@neochair.com

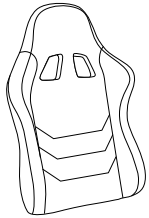

Back

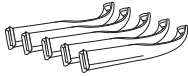

BASE LEG

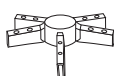

CENTRAL BASE

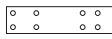

METAL PLATE



GAS LIFT



WHEEL

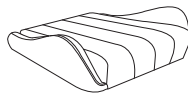

SEAT



ARMREST

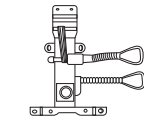

CONTROL MECHANISM



FOOTREST CUSHION



ALLEN KEY

We recommend keeping your Allen key for future maintenance.

HARDWARE



TILTING BOLT X4



PLATE - TILTING X4



ARMREST BOLT X4



PLATE - BACKREST X4



BASE BOLT X 10



FOOTREST BOLT X2



BOLT CAP X4

ACCESSORIES



HEAD CUSHION

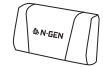

LUMBAR SUPPORT

STEP 1. BASE

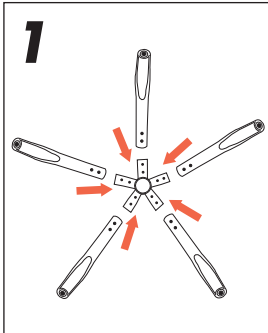
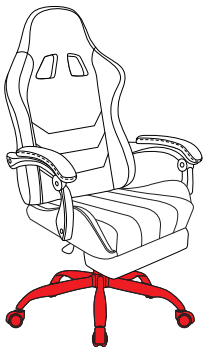

Insert the base legs into the central base so that the bolt holes are aligned and facing up.

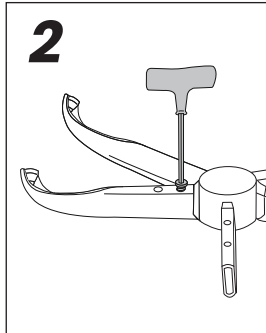

Secure with bolts. Make sure to fully tighten all 10 bolts.

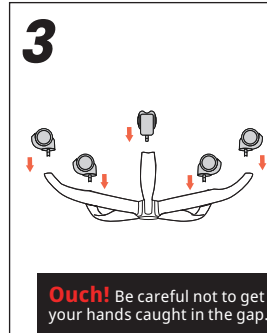

Ouch! Be careful not to get your hands caught in the gap.

Insert each wheel into the base leg while the base is still upside down.

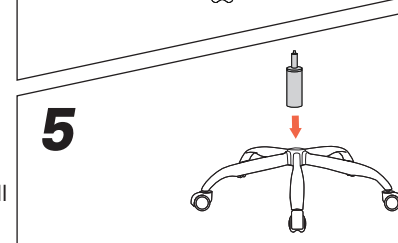
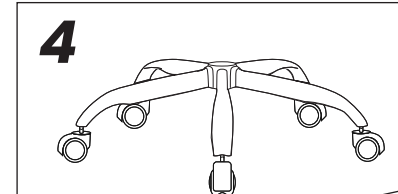

IMPORTANT NOTICE

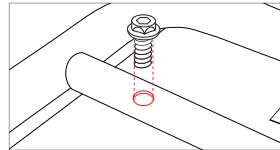

1 THE BOLT HOLES SHOULD BE ALIGNED

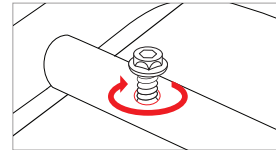

2 UNDER-TIGHTEN THE BOLTS

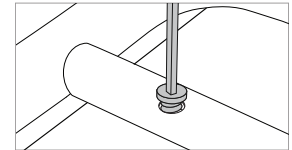

3 TIGHTEN ALL BOLTS

STEP 2. SEAT+FOOTREST

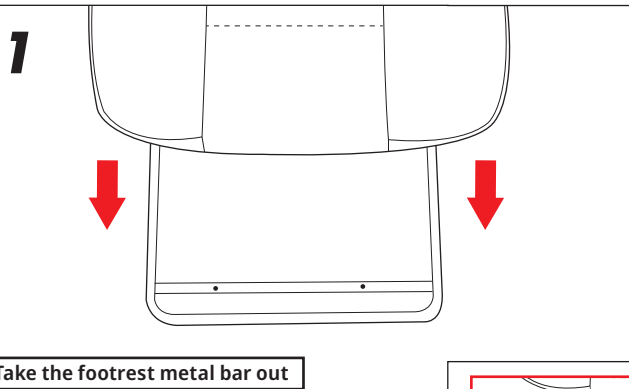
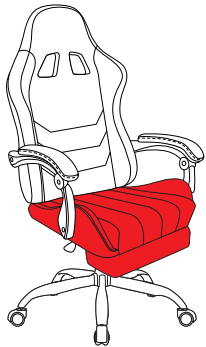

Take the footrest metal bar out

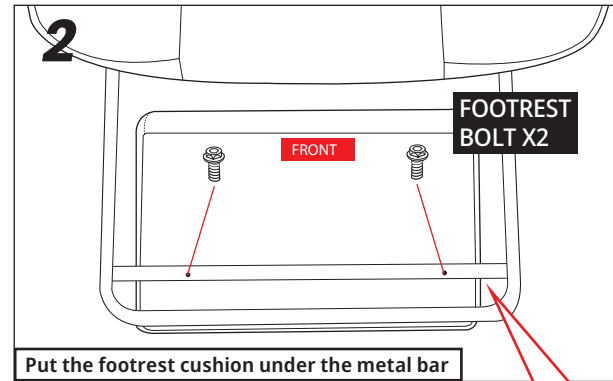

LOOSE BOLT ALERT!

When the bolts seem loose, detach the parts and try inserting the bolts directly into their holes.

*Using an electric drill can damage the chair. Please re-tighten bolts manually.

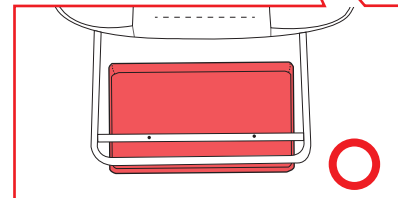
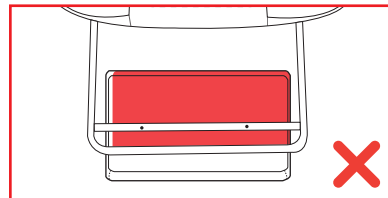

NOTE: Make sure that the cushion is placed within the rectangular metal bar

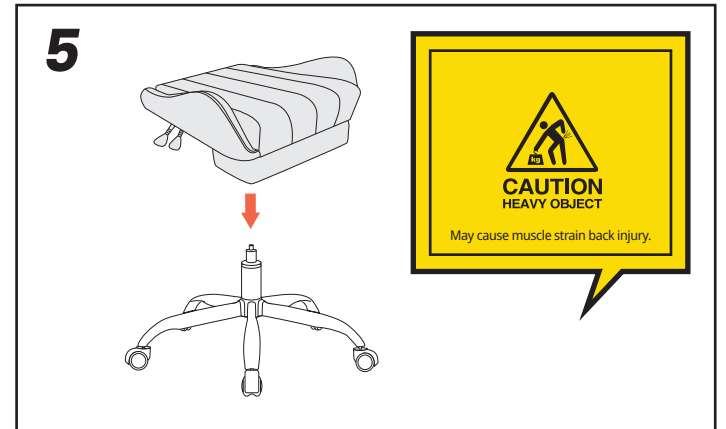
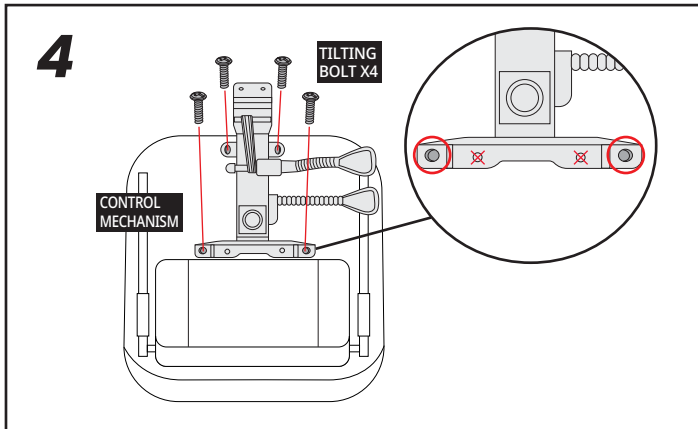
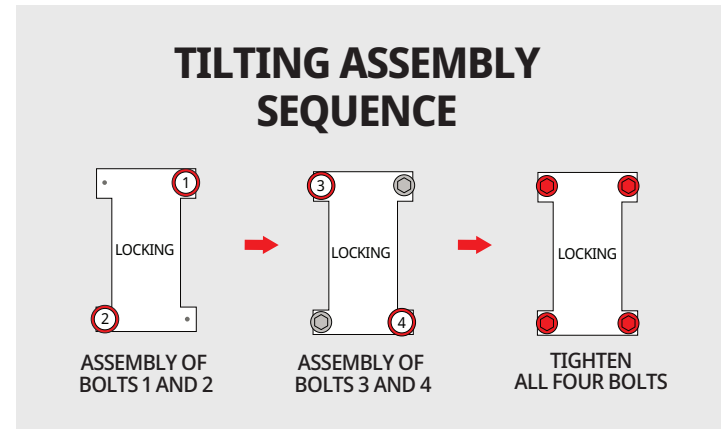
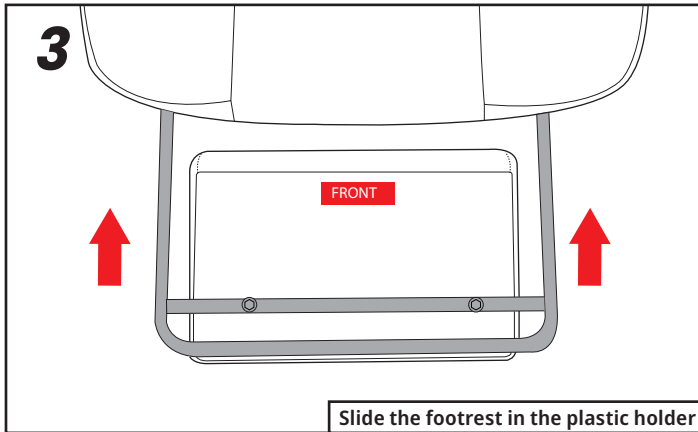

**STEP 3. BACK,
ARMREST**

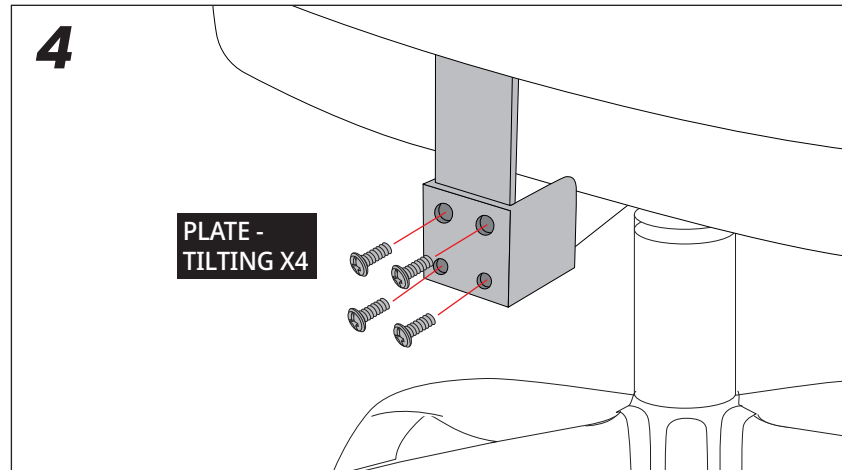
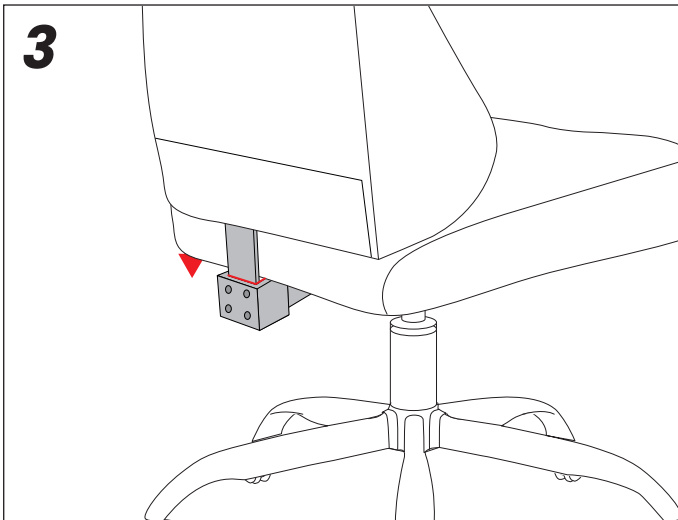
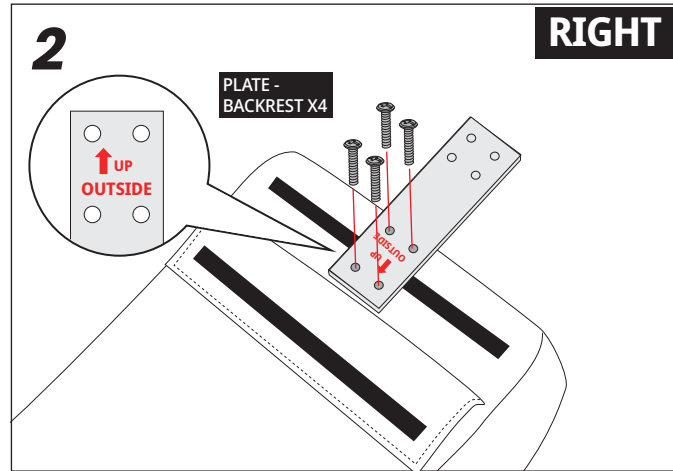
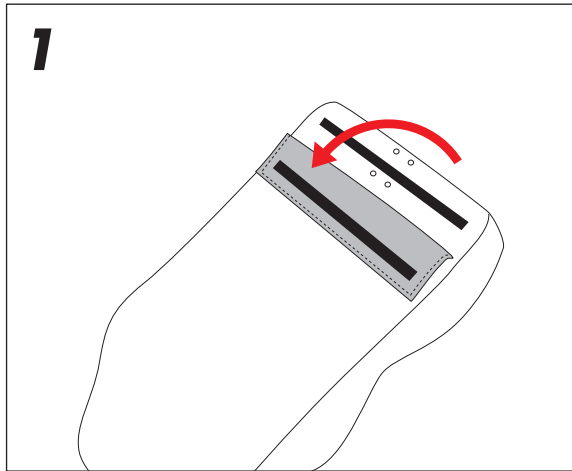
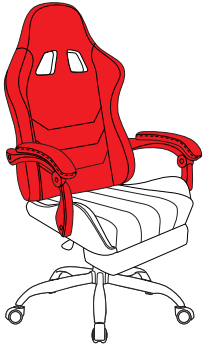

5

LEFT

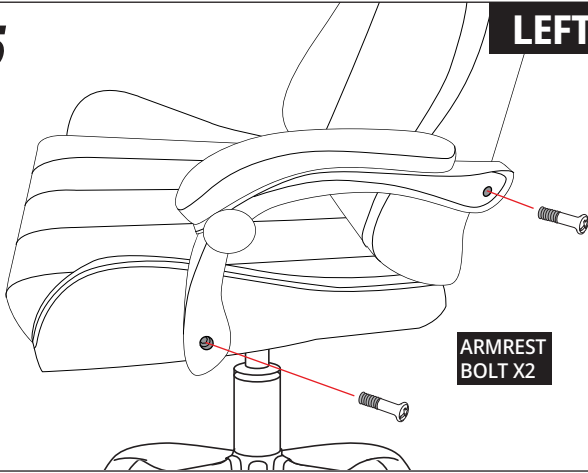

ARMREST BOLT X2

BOLT CAP X4

OPTIONAL

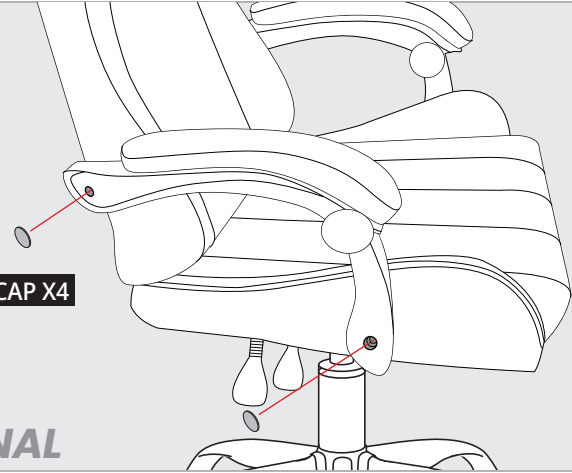

6

RIGHT

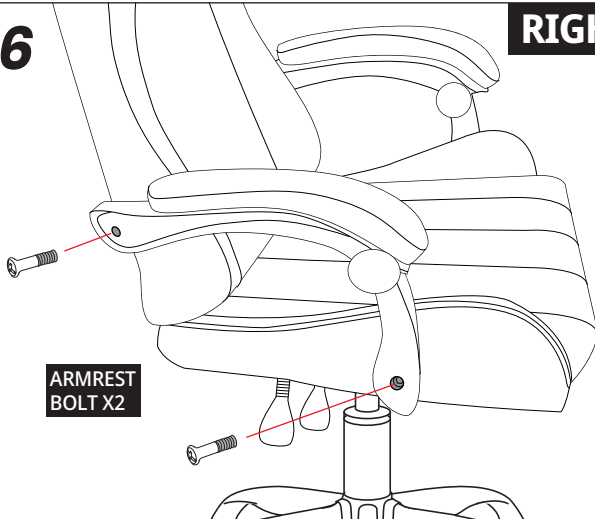

ARMREST BOLT X2

SAFETY INFORMATION



This product is designed for **one person** to sit at a time.



DO NOT use the chair unless all bolts, screws and knobs are tight

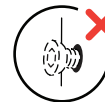

DO NOT use the chair if any of the components is missing or damaged.



DO NOT stand on the chair as a step stool or a ladder.



DO NOT tilt the chair forward, left, or right while sitting.



Be careful **NOT TO FALL** off from the chair.



Be careful, as some parts may be **sharp and heavy**.

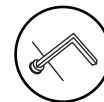

Regularly check and tighten all bolts, screws, and knobs.



Failure to follow these warnings may cause **serious injuries**.



Be careful **not to hit** the furniture edges.



Keep in a **dry and cool** place.



When **moving** the object, proceed with **caution**.

CHECK!!

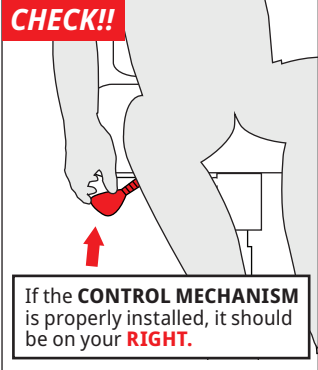

RETRACTABLE FOOTREST

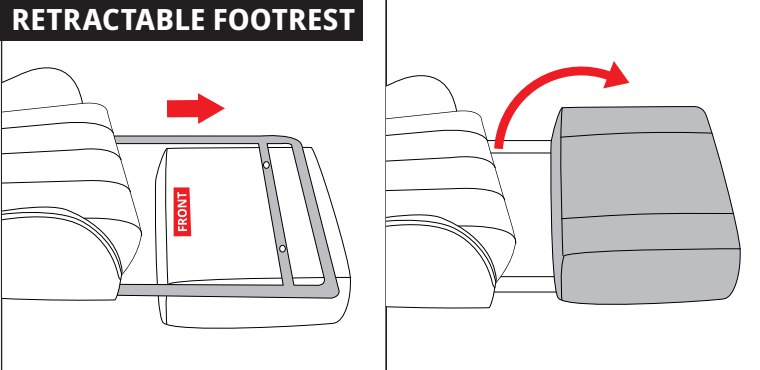

NOTICE!



Do not press armrests hard when standing up, this may damage a product.

RECLINE

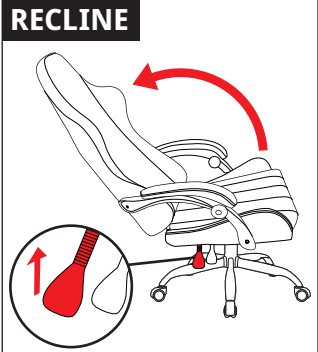

LOCKING

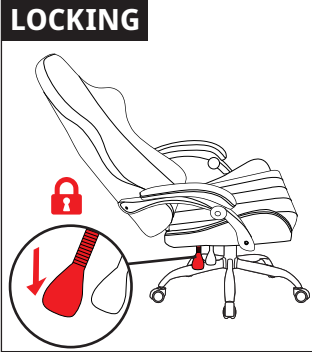

HEIGHT

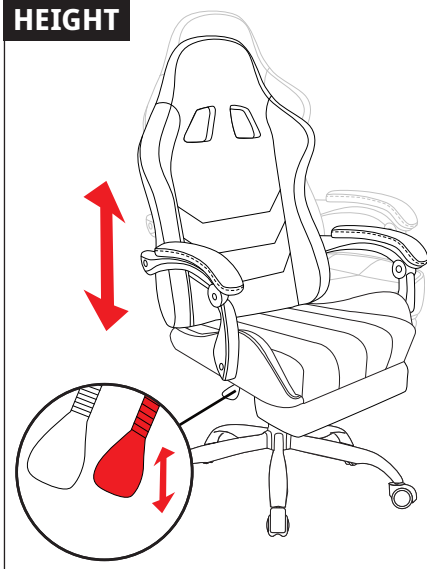

ARMREST

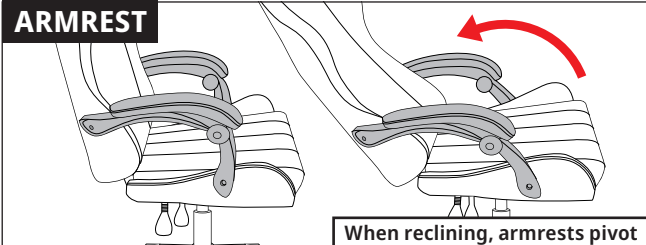

HEAD CUSHION, LUMBAR SUPPORT

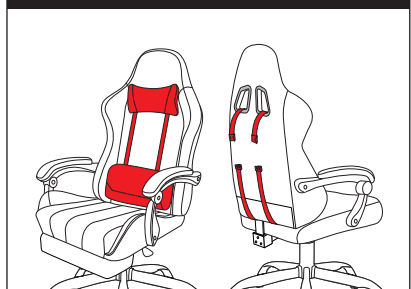



 neo chair
WWW.NEOCHAIR.COM