



## About Polaroid LINK smartphones

**Polaroid LINK smartphones are shipped unlocked and offer the flexibility of using any GSM network (AT&T, T-Mobile and more) and plan you want without any commitment.**

**SIM card (not included)**  
If you already have a SIM card, please refer to "Inserting the SIM card and battery". If you do not have a SIM card, you can purchase one at many major retailers, mobile phone carriers or electronics stores.

**Supported Bands:**  
GSM/GPRS/EDGE 850,900,1800,1900 MHz  
UMTS/HSPA+ 850,1700 (AWS),1900 MHz

**4G HSPA+**  
This phone is HSPA+ capable. HSPA+ is a cellular network data protocol capable of data speeds much faster than standard 3G; in some cases, HSPA+ comes close to LTE speeds but is more widely available than LTE because it uses 3G networks. With an HSPA+ connection this phone can stream video, download apps, upload photos or anything else that requires a high speed data connection.

**Accessibility**  
See, hear, speak, feel, and use. Accessibility features are there for everyone, helping to make things easier.

To use Accessibility features, go to **Settings > Accessibility**.

**Specifications**  
Display: 5.0" (480x854) IPS • OS: Android 4.4, KitKat • Processor: Dual-Core, 1.3GHz • Memory (RAM): 512MB Storage: 8GB\* • Removable Storage: Micro SD card (Supports up to 64GB additional storage) • Cameras: 5MP LED flash (rear), VGA (front) • Battery: 1700 mAh • Wi-Fi: 802.11 b/g/n • Bluetooth: Version 4.0

\*Actual internal memory may vary depending on the operating system of the device and the preloaded apps.

## In the box

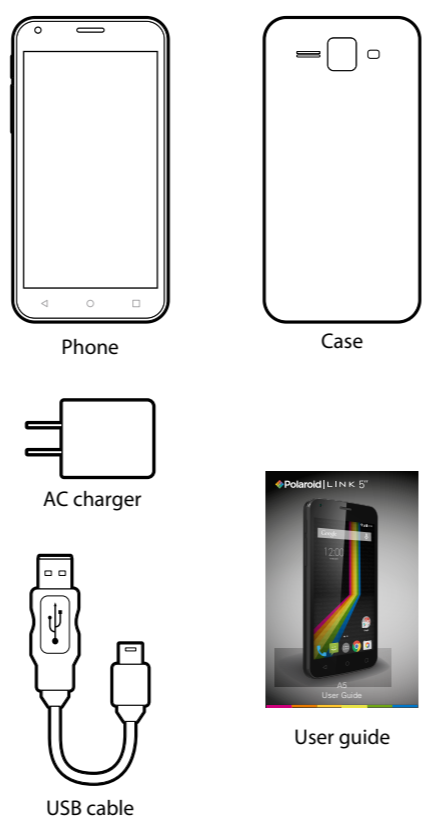

## Location of controls

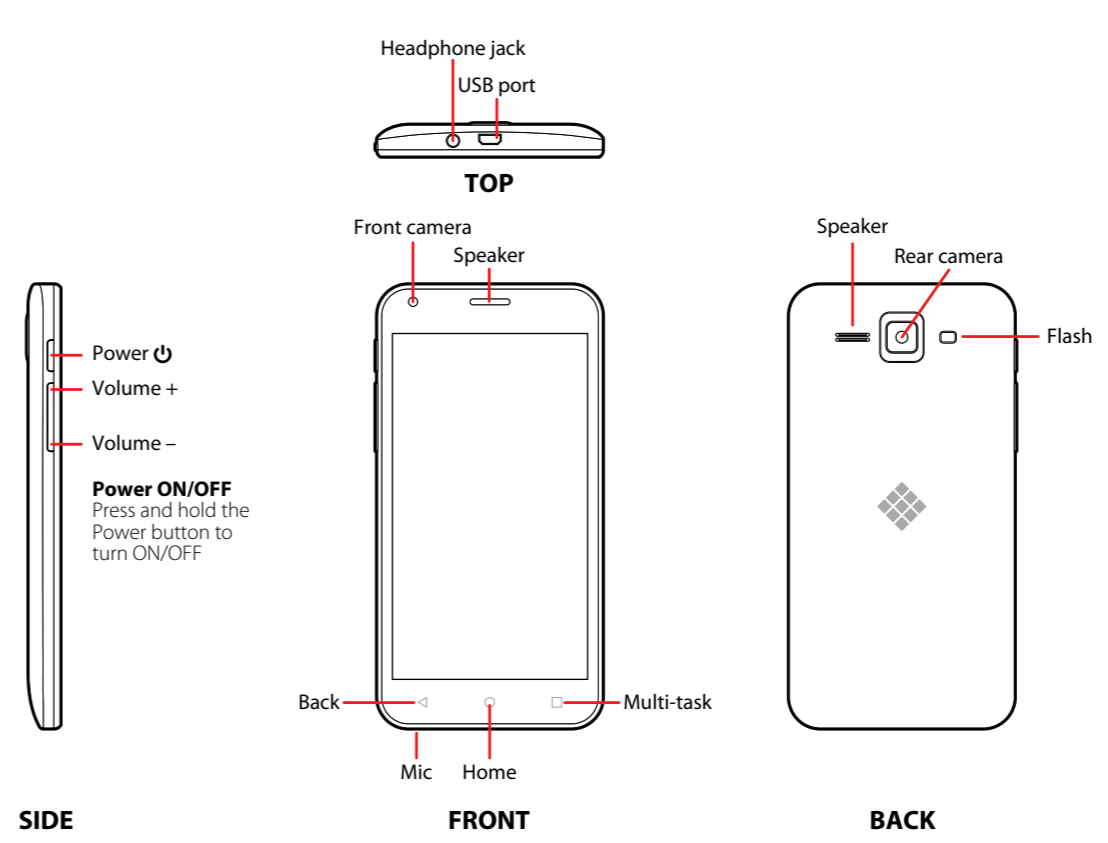

## Inserting the SIM card and battery

1. Carefully open the back cover from the bottom-right corner.

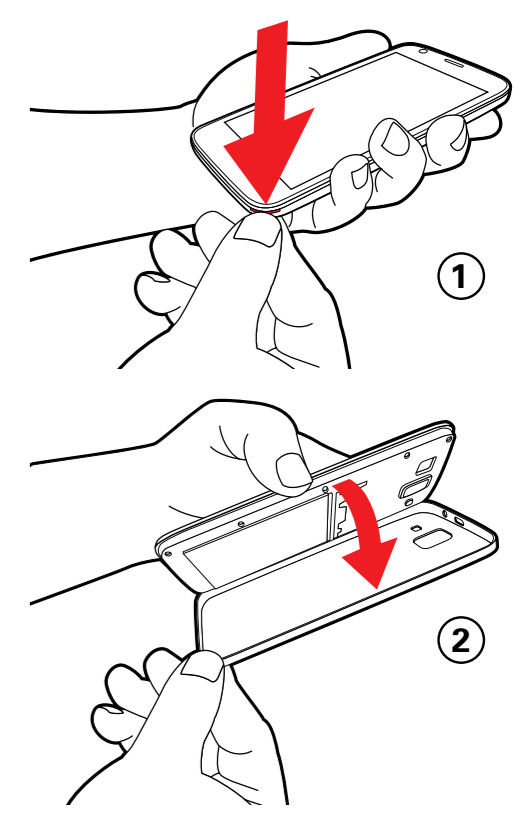

## 2. Insert a SIM or Micro SIM card into the respective slot.

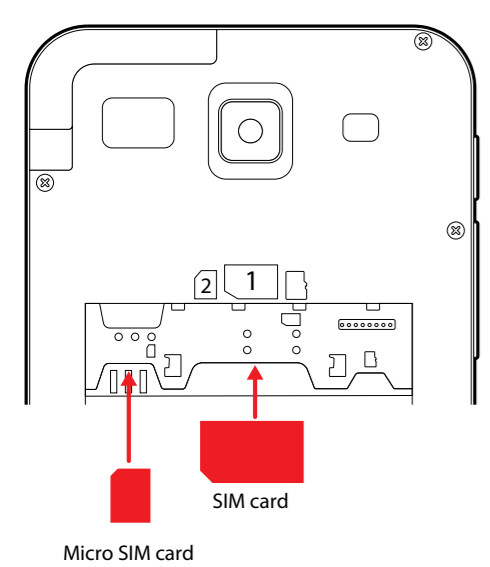

**Dual SIM**  
Dual SIM card slots offer the convenience to access two different phone numbers simultaneously. Additionally, the dual SIM card slots allow you to have two carrier options, such as having regional and international phone numbers.

## 3. Insert the battery as shown below (make sure the contacts of the battery are facing the top-left corner).

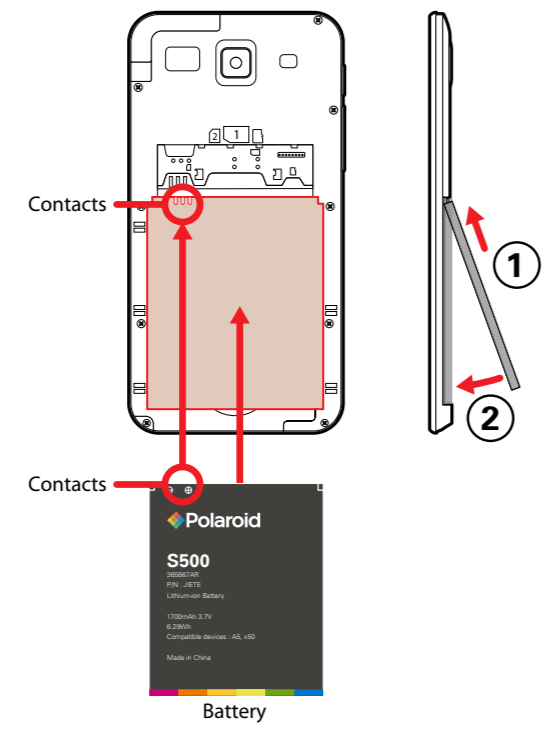

4. Snap the back cover on the phone.

## Charging

Connect the USB cable to the AC charger and phone.

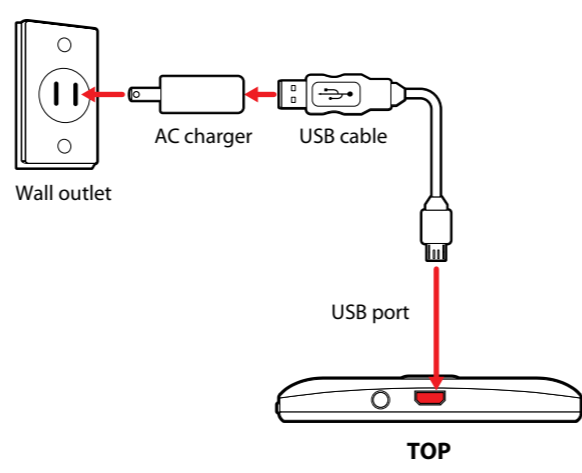

**Battery Tips:**

- Turn off Wi-Fi and Bluetooth when not in use.
- Lock the phone (turning the display off) to shorten charging time.
- To optimize battery time and performance, adjust the "Brightness" and "Screen timeout" options in the Settings app.

## Turning on

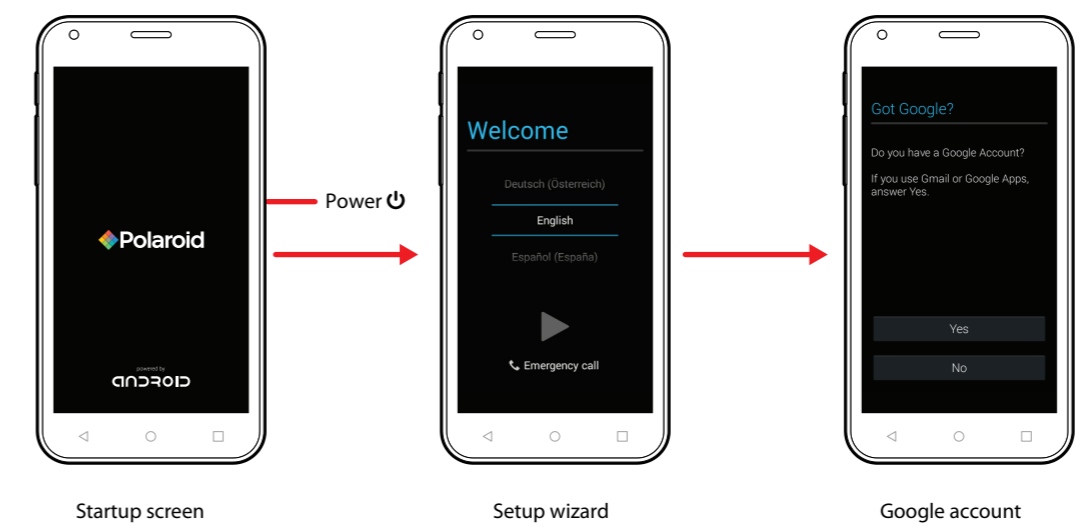

- 1 Press and hold the Power button to get started.
- 2 Follow the initial setup wizard prompts.
- 3 To use the Google Play store, sign into or create a Google account.

If you use Gmail™, you already have a Google account—if not, you can create an account now.

## Google Play™

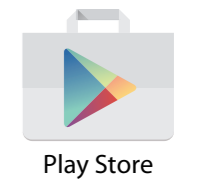

Google Play™ is a digital content experience from Google where you can find and enjoy your favorite music, movies, TV shows, books, and Android™ apps and games. It's your entertainment hub; you can access it from the web or from your Android device, and all your content is instantly available across your devices.



# Notifications and Quick settings

Swipe down from the top edge of the screen to display the Notifications  and Quick settings  screen.



**Notifications**  
You can browse and reply to your emails, text messages and missed calls on the Notifications screen.

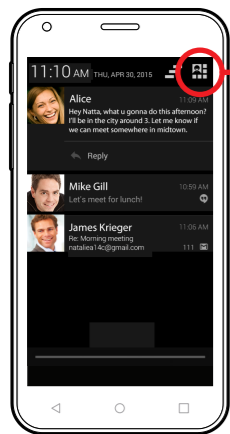

Notifications screen

**Quick settings**  
Easily set up or change Wi-Fi, Bluetooth, Airplane mode and other settings.

Set your owner profile

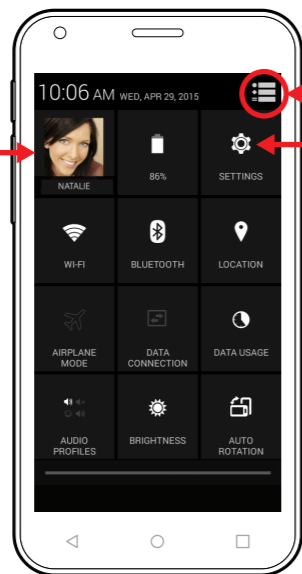

Quick settings screen

 Go to Quick Settings

 Return to Notifications  
 Access more Settings

# Expandable storage

To expand the storage of the phone, you will need to insert a Micro SD card. The phone supports Micro SD cards up to 64GB (not included).

Open the back cover and take out the battery, then insert the Micro SD card into the Micro SD card slot until it snaps into place.

To remove the Micro SD card, use your fingernail to slide it out.

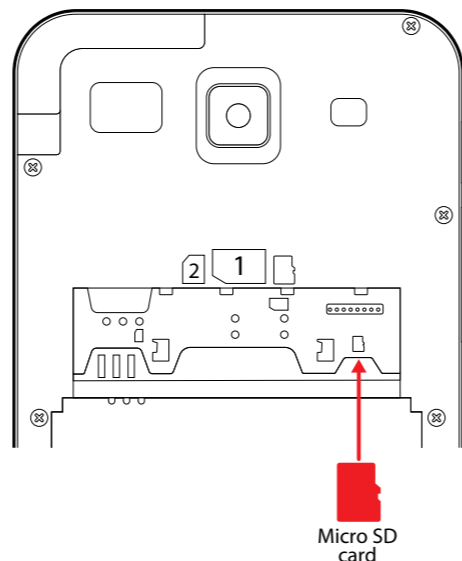

Micro SD card

# Safety, Regulatory and Legal

## Battery Use & Safety

**Warning:** • Don't try to take apart or fix your phone. Attempting to take apart or fix your phone may damage the battery and may cause burning and injury. • Don't crush, bend, or expose your phone to heat or liquid. This may damage the battery and may cause burning and injury.

## Battery Charging

• During charging, keep your mobile device and charger near room temperature for efficient battery charging. • New batteries are not fully charged. • New batteries or batteries stored for a long time may take more time to charge. • The included charger is intended for indoor use only.

## Driving Precautions

Responsible and safe driving is your primary responsibility when driving a vehicle. Making calls or using applications while driving may cause distraction, and may be prohibited or restricted in certain areas—always obey local laws and regulations for the use of mobile devices and accessories in the vehicle. While driving, ALWAYS: • Keep your eyes on the road. • Use a handsfree device if available or required by law in your area. • Enter destination information into a navigation device before driving. • Use voice activated features (such as voice dial) and speaking features (such as audible directions), if available. • Concentrate on driving, and stop using the mobile device if you can't concentrate. Pull over safely before using your mobile device to send messages, surf the web, or use other applications.

## Seizures, Blackouts & Eyestrain

To reduce eyestrain and avoid headaches, it is always a good idea to hold the screen a comfortable distance from your eyes, use in a well-lit area, and take frequent breaks. Some people may be susceptible to seizures or blackouts (even if they have never had one before) when exposed to flashing lights or light patterns, such as when playing video games, or watching videos with flashing-light effects. Discontinue use and consult a physician if any of the following symptoms occur: seizures, blackout, convulsion, eye or muscle twitching, loss of awareness, or disorientation.

## Caution about High Volume Usage

**WARNING:** Exposure to loud noise from any source for extended periods of time may affect your hearing. The louder the sound, the less time is required before your hearing could be affected. To protect your hearing: • Limit the amount of time you use headsets or headphones at high volume. • Avoid turning up the volume to block out noisy surroundings. • Turn the volume down if you can't hear people speaking near you. If you experience hearing discomfort, including the sensation of pressure or fullness in your ears, ringing in your ears, or muffled speech, you should stop listening to the device through your headset or headphones and have your hearing checked.

## Repetitive Motion

When you repetitively perform actions, such as pressing keys, you may experience discomfort in your hands, arms, shoulders, neck, or other parts of your body. If you continue to have discomfort during or after such use, stop use and see a physician.

## Children

Scientific evidence indicates wireless phone use poses no known danger to the users, including children and teenagers. If you are concerned about avoiding even potential risks caused by radio frequency energy (RF), you may put more distance between your body and the source of RF by using a headset or speaker. RF level drops dramatically with distance. Again, any recommendations are precautionary, since no scientific evidence suggests any health hazard and wireless phone use are linked in any way. Keep your mobile device and its accessories away from small children. These products are not toys and may be hazardous to small children. For example, a choking hazard may exist for small, detachable parts. If a child does use your mobile device, monitor their access to help prevent loss of data or unexpected charges for data or application purchases.

## Radio Frequency (RF) Energy

Your mobile device contains a transmitter and receiver of RF energy. It is designed to comply with regulatory requirements concerning human RF exposure. For optimal device performance, and to stay within the RF exposure guidelines: • Hold your mobile phone like a landline when talking on it. • When using the mobile phone next to your body (other than in your hand or against your head), maintain a distance of 2.5 cm (1 inch) from your body to be consistent with how the mobile phone is tested for compliance with RF exposure requirements. • If you use your mobile phone with an accessory case or holder, make sure the accessory is free of metal.

## Glass Parts

Some parts of your mobile device may be made of glass. This glass may break if the product receives a substantial impact. If glass breaks, don't attempt to service the device yourself. Stop using your mobile device until the glass is replaced by a qualified service center.

## Operational Warnings

Obey all posted signs when using mobile devices in public areas. Potentially explosive areas are often, but not always, posted and can include blasting areas, fueling stations, fueling areas (such as below decks on boats), fuel or chemical transfer or storage facilities, or areas where the air contains chemicals or particles, such as grain dust, or metal powders. Turn off your mobile device before entering such an area, and do not charge batteries. In such areas, sparks can occur and cause an explosion or fire.

## Follow Instructions to Avoid Interference Problems

Turn off your mobile device in any location where posted notices instruct you to do so, such as hospitals or health care facilities. In an aircraft, turn off your mobile device whenever instructed to do so by airline staff. If your mobile device offers an airplane mode or similar feature, consult airline staff about using it in flight.

## Medical Devices

If you use an implantable device, such as a pacemaker or defibrillator, consult your healthcare provider and the device manufacturer's directions before using this mobile device. Persons with a pacemaker or defibrillator should observe the following precautions: • ALWAYS keep the mobile device more than 20 centimeters (8 inches) from the pacemaker or defibrillator when the mobile device is turned ON. • Use the ear opposite the pacemaker or defibrillator to minimize the potential for interference. • Turn OFF the mobile device immediately if you have any reason to suspect that interference is taking place.

## Privacy & Data Security

Polaroid understands that privacy and data security are important to everyone. Because some features of your mobile device may affect your privacy or data security, please follow these recommendations to enhance protection of your information: • **Monitor access:** Keep your mobile device with you and don't leave it where others may have unmonitored access. Use your device's security and lock features, where available. • **Keep software up to date:** If Polaroid or a software/application vendor releases a patch or software fix for your mobile device that updates the device's security, install it as soon as possible. • **Secure personal information:** Your mobile device can store personal information in various locations, including your SIM card, memory card, and phone memory. Be sure to remove or clear all personal information before you recycle, return, or give away your device. You can also backup your personal data to transfer to a new device. • **Applications and updates:** Choose your apps and updates carefully, and install from trusted sources only. Some apps can impact your mobile device's performance and/or have access to private information including account details, call data, location details, and network resources. • **Wireless:** For mobile devices with Wi-Fi features, only connect to trusted Wi-Fi networks. Also, when using your device as a hotspot (where available), use network security. These precautions will help prevent unauthorized access to your device. • **Location-based information:** Mobile devices enabled with location based technologies such as GPS, AGPS or Wi-Fi, can transmit location-based information. • **Other information your device may transmit:** Your mobile device may also transmit testing and other diagnostic (including location-based) information, and other non-personal information to Polaroid or other third-party servers. This information is used to help improve products and services offered by Polaroid.

## FCC Part 15:

This equipment has been tested and found to comply with the requirements for a Class B digital device under Part 15 of the Federal Communications Commission (FCC) rules. These requirements are intended to provide reasonable protection against harmful interference in a residential installation. This equipment generates, uses and can radiate radio frequency energy and, if not installed and used in accordance with the instructions, may cause harmful interference to radio communications. However, there is no guarantee that interference will not occur in a particular installation. If this equipment does cause harmful interference to radio or television reception, which can be determined by turning the equipment off and on, the user is encouraged to try to correct the interference by one or more of the following measures: • Re-orient or relocate the receiving antenna. • Increase the separation between the equipment and receiver. • Connect the equipment into an outlet on a circuit different from that to which the receiver is connected. • Consult the dealer or an experienced radio/TV technician for help.

## Do not attempt to repair or modify this equipment.

**Warning:** Changes or modifications to this equipment not expressly approved by the party responsible for compliance could void the user's authority to operate the equipment. This device complies with Part 15 of the FCC Rules. Operation is subject to the following two conditions: (1) this device may not cause harmful interference, and (2) this device must accept any interference received, including interference that may cause undesired operation.

## Shielded USB cables must be used with this unit to ensure compliance with the Class B FCC limits.

## FCC RF Exposure Information

**WARNING! Read this information before operating the phone.** In August 1996, the Federal Communications Commission (FCC) of the United States, with its action in Report and Order FCC 96-326, adopted an updated safety standard for human exposure to radio frequency (RF) electromagnetic energy emitted by FCC regulated transmitters. Those guidelines are consistent with the safety standard previously set by both U.S. and international standards bodies. The design of this phone complies with the FCC guidelines and these international standards.

## Specific Absorption Rate (SAR)

This phone meets the government's requirements for exposure to radio waves. A wireless phone is a radio transmitter and receiver. It is designed and manufactured not to exceed the emission limits for exposure to radio frequency (RF) energy set by the FCC. These limits are part of comprehensive guidelines and establish permitted levels of RF energy for the general population. The guidelines are based on standards that were developed by independent scientific organizations through periodic and thorough evaluation of scientific studies. The standards include a substantial safety margin designed to assure the safety of all persons, regardless of age and health. The exposure standard for wireless mobile phones uses a unit of measurement known as the Specific Absorption Rate, or SAR. The SAR limit set by the FCC is 1.6W/kg. Tests for SAR are conducted using standard operating positions specified by the FCC with the phone transmitting at its highest certified power level in all tested frequency bands. Although SAR is determined at the highest certified power level, the actual SAR level of the phone while operating can be well below the maximum value. Because the phone is designed to operate at multiple power levels to use only the power required to reach the network, in general, the closer you are to a wireless base station antenna, the lower the power output.

### The SAR information for this phone is as follows:

Head: 0.283W/Kg  
Body: 0.92W/Kg

## Body-worn Operation

This device was tested for typical body-worn operations with the back of the phone kept 0.4 inch (1 cm) between the user's body and the back of the phone. To comply with FCC RF exposure requirements, a minimum separation distance of 0.4 inch (1 cm) must be maintained between the user's body and the back of the phone. Third-party belt-clips, holsters, and similar accessories containing metallic components should not be used. Body-worn accessories that cannot maintain 0.4 inch (1 cm) separation distance between the user's body and the back of the phone, and have not been tested for typical body-worn operations may not comply with FCC RF exposure limits and should be avoided.

## Battery Disposal & Recycle

Dispose of the battery in accordance with government regulations. We encourage you to call the number below to have the battery recycled and help protect the environment.

☎ 1-800-822-8837



PLR IP Holdings, LLC, its licensees and affiliates, fully support all electronic waste initiatives. As responsible stewards of the environment, and to avoid violating established laws, you should properly dispose of this product in compliance with all applicable regulations, directives or other governances in the area where you reside. Please check with local authorities or the retailer where you purchased this product to determine a location where you can appropriately dispose of the product.

You may also go to [www.polaroid.com](http://www.polaroid.com) and reference **Social Responsibility** <http://www.polaroid.com/social-responsibility> to learn more about the specific laws in your area and to locate a collection facility near your home.

If your electronic device has internal memory on which personal or other confidential data may be stored, you may want to perform a data sanitization process before you dispose of your device to assure another party cannot access your personal data. Data sanitization varies by the type of product and its software, and you may want to research the best sanitization process for your device before disposal. You may also check with your local recycling facility to determine their data sanitization procedures during the recycling process.

# Limited Warranty

## LIMITED WARRANTY TO ORIGINAL CONSUMER

This Product (including any accessories included in the original packaging) as supplied and distributed new by an authorized retailer is warranted by AIT, Inc. (AIT) to the original consumer purchaser against defects in materials and workmanship ("Warranty") as follows:

Product Type : Smartphone Territory : United States / Canada  
Parts Warranty : 1 Year Labor Warranty : 1 Year

### Customer Support:

☎ 1-877-768-8481 (Toll Free)  
Monday - Friday: 8AM - 10PM (EST)  
🌐 [www.southerntelecom.com](http://www.southerntelecom.com)  
(click on "Product Support")

## TO OBTAIN WARRANTY SERVICE:

• Call the Customer Support number located below, or go to our website portal to receive an SRO number. • Provide proof of the date of purchase within the package (Dated bill of sale). • Prepay all shipping costs to the authorized service center, and remember to insure your return. • Include a return shipping address (no P.O. Boxes), a telephone contact number, and the defective unit within the package. • Describe the defect or reason you are returning the product.

Your product will be repaired or replaced, at our option, for the same or similar model of equal value if examination by the service center determines this product is defective. Products received damaged as a result of shipping will require you to file a claim with the carrier.

## The shipping address of the authorized service center is:

📍 **Southern Telecom, Inc.**  
**Attention: Customer Service (2nd Floor)**  
**14-C 53rd Street**  
**Brooklyn, NY 11232**

## Warranty service not provided

This warranty does not cover damage resulting from accident, misuse, abuse, improper installation or operation, lack of reasonable care, unauthorized modification including software modifications such as the installation of custom firmwares. This warranty is voided in the event any unauthorized person opens, alters or repairs this product. All products being returned to the authorized service center for repair must be suitably packaged.

NO WARRANTIES, WHETHER EXPRESS OR IMPLIED, INCLUDING, BUT NOT LIMITED TO, ANY IMPLIED WARRANTIES OF MERCHANTABILITY OR FITNESS FOR A PARTICULAR PURPOSE, OTHER THAN THOSE EXPRESSLY DESCRIBED ABOVE SHALL APPLY. DISTRIBUTOR FURTHER DISCLAIMS ALL WARRANTIES AFTER THE EXPRESS WARRANTY PERIOD STATED ABOVE. NO OTHER EXPRESS WARRANTY OR GUARANTY GIVEN BY ANY PERSON, FIRM OR ENTITY WITH RESPECT TO THE PRODUCT SHALL BE BINDING ON DISTRIBUTOR. REPAIR, REPLACEMENT, OR REFUND OF THE ORIGINAL PURCHASE PRICE - AT DISTRIBUTOR'S SOLE DISCRETION - ARE THE EXCLUSIVE REMEDIES OF THE CONSUMER. IN NO EVENT WILL DISTRIBUTOR, ITS MANUFACTURERS, OR PLR IP HOLDINGS, LLC BE LIABLE FOR ANY INCIDENTAL, DIRECT, INDIRECT, SPECIAL, PUNITIVE OR CONSEQUENTIAL DAMAGES (SUCH AS, BUT NOT LIMITED TO, DAMAGES FOR LOSS OF PROFITS, BUSINESS, SAVINGS, DATA OR RECORDS) CAUSED BY THE USE, MISUSE OR INABILITY TO USE THE PRODUCT. EXCEPT AS STATED HEREIN, NO OTHER WARRANTIES SHALL APPLY. NOTWITHSTANDING THE FOREGOING, CONSUMER'S RECOVERY AGAINST DISTRIBUTOR SHALL NOT EXCEED THE PURCHASE PRICE OF THE PRODUCT SOLD BY DISTRIBUTOR. THIS WARRANTY SHALL NOT EXTEND TO ANYONE OTHER THAN THE ORIGINAL CONSUMER WHO PURCHASED THE PRODUCT AND IS NOT TRANSFERABLE.

Some countries, states or provinces do not allow the exclusion or limitation of incidental or consequential damages or allow limitations on warranties, so limitation or exclusions may not apply to you. This warranty gives you specific legal rights, and you may have other rights that vary from state to state or province to province. Contact your authorized retailer to determine if another warranty applies.

Designed by Southern Telecom / Made in China  
Distributed by: AIT, Inc. 14-C 53rd Street Brooklyn, NY 11232  
© 2015 All Rights Reserved.

Polaroid, Polaroid & Pixel, Polaroid Color Spectrum, Polaroid Classic Border Logo and Polaroid Link are trademarks of PLR IP Holdings, LLC, used under license. PLR IP Holdings, LLC does not manufacture this product or provide any Manufacturer's Warranty or support. [www.polaroid.com](http://www.polaroid.com)

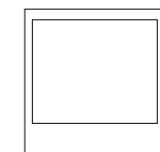

Instantly recognizable. Instantly reassuring. The Polaroid Classic Border and Polaroid Color Spectrum logos lets you know you've purchased a product that exemplifies the best qualities of our brand and that contribute to our rich heritage of quality and innovation.

The **Bluetooth**® word mark and logos are owned by the Bluetooth SIG, Inc.

Android, Google, Google Play and other marks are trademarks of Google Inc. The Android robot is reproduced or modified from work created and shared by Google and used according to terms described in the Creative Commons 3.0 Attribution License.

All other trademarks and trade names are those of their respective owners.