

KENWOOD

PKT-300 PKT-300LF

UHF FM TRANSCEIVER

USER MANUAL

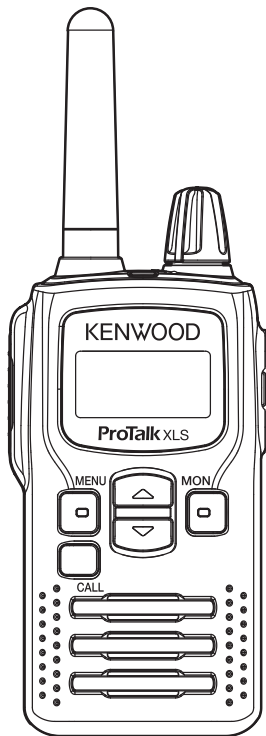

ProTalk XLS

CONTENTS

FEATURES	4
PREPARATION	5
INSTALLING/ REMOVING THE BATTERY PACK	5
CHARGING THE BATTERY PACK	6
INSTALLING/ REMOVING THE BELT CLIP HOLSTER	7
INSTALLING THE OPTIONAL SPEAKER/ MICROPHONE (OR HEADSET)	7
ORIENTATION	8
BUTTONS AND CONTROLS	8
DISPLAY	9
BASIC OPERATION	10
SWITCH THE POWER ON	10
ADJUST THE VOLUME	10
SELECT A CHANNEL	10
MAKE A CALL	11
MENU MODE	12
QUIET TALK/ DIGITAL QUIET TALK	12
OPERATING QT/ DQT SETTING (ONLY PKT-300LF)	12
PRIVACY TALK	14
TRANSMIT POWER.....	14
COMPANDER	14
MONITOR	15
LOCK FUNCTION	15
KEY LOCK	15
SUPER LOCK.....	15
SETTING MODE	16
CHANNEL FREQUENCY SETUP	18
DEFAULT CHANNEL	19
INCOMING CALL NOTIFICATION (PKT-300LF ONLY)	19
KEY ASSIGNMENT MODE (PKT-300LF ONLY)	20
Programmable Functions.....	20
CALL ALERT TONE	21
CALL ALERT SIDE TONE (PKT-300LF ONLY)	21

MODE RESET TIMER (PKT-300LF ONLY)	22
TIME-OUT TIMER (PKT-300LF ONLY)	22
BUSY CHANNEL LOCKOUT (BCL) (PKT-300LF ONLY)	23
BACKLIGHT	23
BATTERY LEVEL INDICATOR	24
BATTERY SAVER	24
BEEP TONE	25
SCAN (PKT-300LF ONLY)	25
REVERT CHANNEL	26
SQUELCH LEVEL	26
MIC SENSE (PKT-300LF ONLY)	26
VOICE OPERATED TRANSMISSION (VOX)	27
VOX OPERATION	27
VOX GAIN LEVEL	27
VOX DELAY TIME	27
VOX CANCEL OPERATION	28
TRANSMIT INHIBIT WHILE RECEIVING	28
VOX PROCEED TONE	28
SELECTABLE POWER ON TONE	29
RESETTING THE TRANSCEIVER (PKT-300LF ONLY)	29
OPTION	30
TROUBLESHOOTING GUIDE	31
SPECIFICATIONS	31

FEATURES

- Lightweight and compact design using a lithium-ion battery pack, with a sturdy, polycarbonate body and a spring-loaded belt clip.
- Many tone/code settings for each channel, allowing you to ignore unwanted calls.
- Privacy Talk scrambles all your voice messages, giving you complete privacy for your conversations.
- Allowing a variety of call types.
- Automatic battery power saver, providing you with longer battery usage.
- Battery power level indicator with low battery power warning.
- Key lock and Super Lock prevent you from accidentally changing your transceiver settings.
- Ten different calling alert tones allows you to identify yourself to your group before you begin speaking.
- Hands free operation when using an optional headset.
- Selectable Power ON Tone.

PREPARATION

INSTALLING/ REMOVING THE BATTERY PACK



CAUTION

- ◆ Do not short the battery terminals or dispose of the battery by fire. Never attempt to remove the casing from the battery pack.

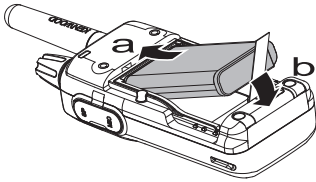

- 1 Align the battery pack with the grooves on the back of the transceiver and insert it. (a → b)

- Pay attention to the position of notch of the battery pack.
- Insert the battery pack.

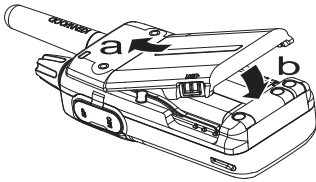

- 2 Align and insert the battery cover to the groove on the back of the transceiver, and then close it. (a → b)

- When closing the battery cover, insert the ribbon inside.

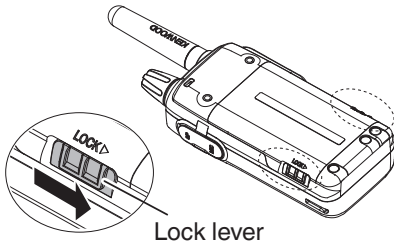

- 3 Slide the Lock lever (both sides) to lock it.

- There will be feedback in the form of a click.
- To remove the battery pack, release the lock on the battery cover, then remove the battery cover and pull the ribbon upwards.

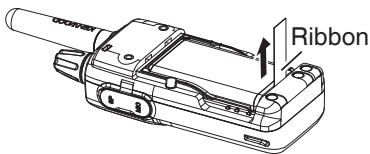

CHARGING THE BATTERY PACK

The battery pack is not charged at the factory; charge it before use.

ATTENTION:

- ◆ Always switch OFF a transceiver equipped with a battery pack before inserting the transceiver into the charger.

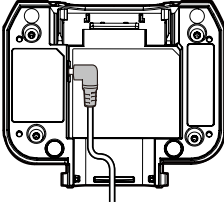

- 1 Plug the AC adapter cable into the jack located on the rear of the charger.

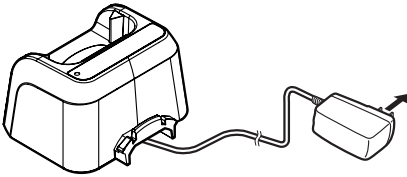

- 2 Plug the AC adapter into an AC outlet.

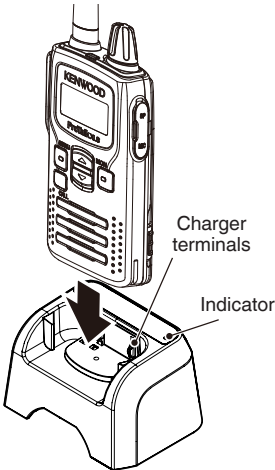

- 3 Slide a battery pack or a transceiver equipped with a battery pack into the charging slot of the charger.
 - Make sure the metal contacts of the battery pack mate securely with the charger terminals.
 - The indicator lights red and charging begins.
- 4 When charging is completed, the indicator flashing green. Remove the battery pack or the transceiver from the charging slot of the charger.

Note:

- ◆ When the indicator blinks red, the battery pack is either defective or the battery pack contacts are not properly mated with those of the charger.
- ◆ The ambient temperature should be between 5°C and 40°C while charging is in progress. Charging outside this range may not fully charge the battery.
- ◆ The battery pack life is over when its operating time decreases even though it is fully and correctly charged. Replace the battery pack.

INSTALLING/ REMOVING THE BELT CLIP HOLSTER

Installation:

Installing the transceiver on the belt clip holster.

- Push the lock lever on the top of the holster toward the arrow to lock it.

Remove:

Push the lock lever on the top of the holster toward the arrow to unlock and pull out the transceiver.

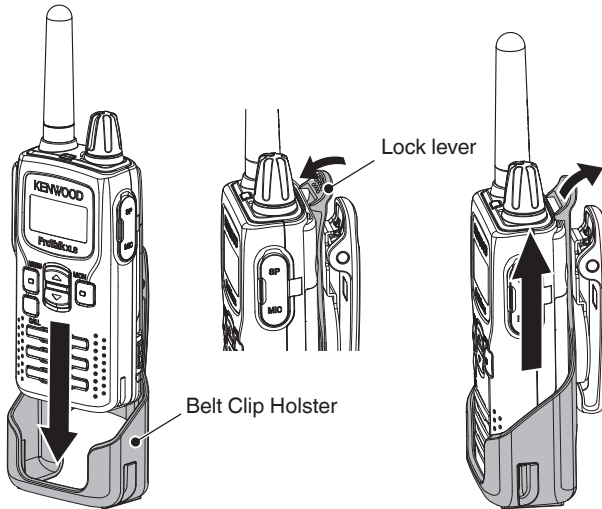

INSTALLING THE OPTIONAL SPEAKER/ MICROPHONE (OR HEADSET)

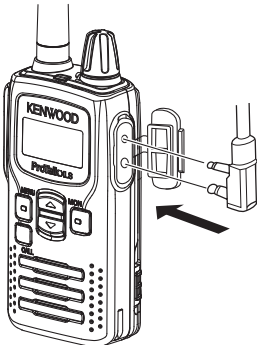

- 1 Open the **SP/MIC** tabs on the side of the transceiver.
- 2 Insert the accessory's plugs into the **SP/MIC** jacks.
- 3 When you remove the accessory from the transceiver, be sure to cover the **SP/MIC** jacks with the attached tabs, in order to keep dust and dirt away from the contacts.

ORIENTATION

BUTTONS AND CONTROLS

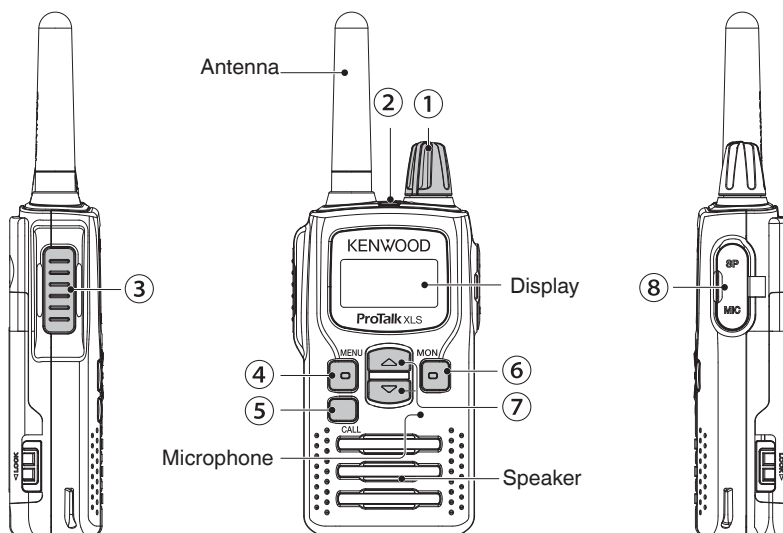

① Power switch/ Volume control

Turn clockwise to switch ON the transceiver. To switch OFF the transceiver, turn counterclockwise until a click sounds. Rotate to adjust the volume level.

② LED indicator

Indicates the transceiver status.

③ [PTT] (Push to Talk) switch

Press and hold, then speak into the microphone to transmit.

④ [MENU] button

Press to perform various functions. Press and hold while switching the power ON to enter Setting Mode.

⑤ [CALL] button

Press before making a call to alert the other party members.

⑥ [MON] button

Press to monitor the current channel for activity.

⑦ [▲] / [▼] buttons







Press to change the operating channel, to select a menu in Setting Mode, and to perform other functions.

⑧ SP/MIC jacks

Insert the speaker/ microphone or headset plug into this jack.

DISPLAY



Icon	Description
VOX	Appears when VOX is activated.
LOW	Appears when using low transmit power.
DQT	Appears when the channel is set up with a DQT code.
SEL	Not Used.
	Displays the approximate battery power remaining. Blinks when the battery power is low, while transmitting.
	Appears when Privacy Talk is activated.
	Not Used.
	Displays the channel number along with its QT/DQT setting (if any). Also displays various menus and menu settings.
.	Appears when compander is activated.
	Appears while monitoring a channel.
	Appears when the transceiver buttons have been locked.

BASIC OPERATION

SWITCH THE POWER ON

Turn the **Power** switch/ **Volume** control clockwise to switch the transceiver ON.

Power-on tone sounds and the transceiver displays all segments. Then for GMRS/FRS models, the transceiver will display "FrS" for 2 seconds, then the channel; for LMR models, the channel is displayed directly.

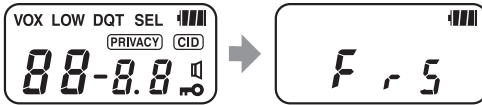

To turn off the power, turn the **Power** switch/ **Volume** control counterclockwise until it clicks at the OFF Position.

ADJUST THE VOLUME

Rotate the **Power** switch/ **Volume** control to adjust the volume. Clockwise increases the volume and counterclockwise decreases it.

- Set your desired volume level by rotating the **Power** switch/ **Volume** control.



SELECT A CHANNEL

Select a channel by pressing the [▲] or [▼] button.

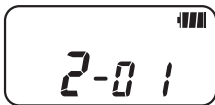

for GMRS/FRS model



for LMR model



- A confirmation tone sounds each time you press the [▲] or [▼] button.
- When you receive a call on your selected channel, you will hear audio from the speaker and the LED will light green.

MAKE A CALL

1 Press the **[MON]** button to make sure the channel is not in use.



2 Press and release the **[CALL]** button to alert the other parties that you are beginning a call.

- A call alert tone will sound on the other party's transceiver.
- If the function setting of the **[CALL]** button is other than "Calling Alert", it will not activate.



3 Press and hold the **[PTT]** switch, then speak into the speaker area to transmit.

- The LED lights red while transmitting.
- For best sound quality, speak into the speaker area in your normal speaking voice while holding the transceiver approximately 1.5 inches (3 to 4 cm) from your mouth.

4 Release the **[PTT]** switch when you have finished speaking.



MENU MODE

Each setting in menu mode is set for each channel.

QUIET TALK/ DIGITAL QUIET TALK

QT (Quiet Talk) and DQT (Digital Quiet Talk) are functions that reject signals from undesired parties that are using the same channel as you. You will hear audio from the speaker only when you receive a signal that contains a tone or code matching the one set up on the channel you are using. Likewise, when you transmit on a channel set up with QT or DQT, the receiving station must have a matching tone or code in order to hear your signal. You can select a tone or code for each channel. There are 45 QT tones and 174 DQT codes. After changing the QT/ DQT setting, confirm that the other members in your group have selected the same tone or code.

■ OPERATING QT/ DQT SETTING (ONLY PKT-300LF)

- Press **[MENU]** to enter Menu Mode. Use **[MENU]** to select the QT/DQT setting mode item to be configured.
 - The QT/DQT number is displayed and blinks.



- Press the **[▲]** or **[▼]** button to select the signaling number.



- Press the **[CALL]** button, the **[MON]** button, or the **[PTT]** switch to store the settings and return to normal operation.

QT Signaling Table: PKT-300LF(GMRS/FRS model)

QT No.	QT Frq. (Hz)	QT No.	QT Frq. (Hz)	QT No.	QT Frq. (Hz)	QT No.	QT Frq. (Hz)
Off	Off	13	103.5	26	162.2	39	69.3
1	67.0	14	107.2	27	167.9	40	Customized
2	71.9	15	110.9	28	173.8	41	Customized
3	74.4	16	114.8	29	179.9	42	Customized
4	77.0	17	118.8	30	186.2	43	Customized
5	79.7	18	123.0	31	192.8	44	Customized
6	82.5	19	127.3	32	203.5	45	Customized
7	85.4	20	131.8	33	210.7		
8	88.5	21	136.5	34	218.1		
9	91.5	22	141.3	35	225.7		
10	94.8	23	146.2	36	233.6		
11	97.4	24	151.4	37	241.8		
12	100.0	25	156.7	38	250.3		

DQT Signaling Table : PKT-300LF(GMRS/FRS model)

DQT No.	DQT Code	DQT No.	DQT Code	DQT No.	DQT Code	DQT No.	DQT Code
1	D023N	51	D411N	101 (A1)	D116I	151 (F1)	D606I
2	D025N	52	D412N	102 (A2)	D125I	152 (F2)	D612I
3	D026N	53	D413N	103 (A3)	D131I	153 (F3)	D624I
4	D031N	54	D423N	104 (A4)	D132I	154 (F4)	D627I
5	D032N	55	D431N	105 (A5)	D134I	155 (F5)	D631I
6	D043N	56	D432N	106 (A6)	D143I	156 (F6)	D632I
7	D047N	57	D445N	107 (A7)	D152I	157 (F7)	D654I
8	D051N	58	D464N	108 (A8)	D155I	158 (F8)	D662I
9	D054N	59	D465N	109 (A9)	D156I	159 (F9)	D664I
10	D065N	60	D466N	110 (b0)	D162I	160 (G0)	D703I
11	D071N	61	D503N	111 (b1)	D165I	161 (G1)	D712I
12	D072N	62	D506N	112 (b2)	D172I	162 (G2)	D723I
13	D073N	63	D516N	113 (b3)	D174I	163 (G3)	D731I
14	D074N	64	D532N	114 (b4)	D205I	164 (G4)	D732I
15	D114N	65	D546N	115 (b5)	D223I	165 (G5)	D734I
16	D115N	66	D565N	116 (b6)	D226I	166 (G6)	D743I
17	D116N	67	D606N	117 (b7)	D243I	167 (G7)	D754I
18	D125N	68	D612N	118 (b8)	D244I	168 (G8)	D645I
19	D131N	69	D624N	119 (b9)	D245I	169 (G9)	Customized
20	D132N	70	D627N	120 (C0)	D251I	170 (H0)	Customized
21	D134N	71	D631N	121 (C1)	D261I	171 (H1)	Customized
22	D143N	72	D632N	122 (C2)	D263I	172 (H2)	Customized
23	D152N	73	D654N	123 (C3)	D265I	173 (H3)	Customized
24	D155N	74	D662N	124 (C4)	D271I	174 (H4)	Customized
25	D156N	75	D664N	125 (C5)	D306I		
26	D162N	76	D703N	126 (C6)	D311I		
27	D165N	77	D712N	127 (C7)	D315I		
28	D172N	78	D723N	128 (C8)	D331I		
29	D174N	79	D731N	129 (C9)	D343I		
30	D205N	80	D732N	130 (d0)	D346I		
31	D223N	81	D734N	131 (d1)	D351I		
32	D226N	82	D743N	132 (d2)	D364I		
33	D243N	83	D754N	133 (d3)	D365I		
34	D244N	84	D645N	134 (d4)	D371I		
35	D245N	85	D023I	135 (d5)	D411I		
36	D251N	86	D025I	136 (d6)	D412I		
37	D261N	87	D026I	137 (d7)	D413I		
38	D263N	88	D031I	138 (d8)	D423I		
39	D265N	89	D032I	139 (d9)	D431I		
40	D271N	90	D043I	140 (E0)	D432I		
41	D306N	91	D047I	141 (E1)	D445I		
42	D311N	92	D051I	142 (E2)	D464I		
43	D315N	93	D054I	143 (E3)	D465I		
44	D331N	94	D065I	144 (E4)	D466I		
45	D343N	95	D071I	145 (E5)	D503I		
46	D346N	96	D072I	146 (E6)	D506I		
47	D351N	97	D073I	147 (E7)	D516I		
48	D364N	98	D074I	148 (E8)	D532I		
49	D365N	99	D114I	149 (E9)	D546I		
50	D371N	100 (A0)	D115I	150 (F0)	D565I		

PRIVACY TALK

Whereas the QT and DQT functions allow you to ignore unwanted calls, Privacy Talk allows you to hold a conversation in complete privacy. When this function is activated, any other party that is listening to your channel will be unable to understand your conversation.

- 1 Press the **[MENU]** button to enter Menu Mode. Use the **[MENU]** button to select Privacy setting mode.
 - The **PRIVACY** icon appears on the display and blinks.
- 2 Press the **[▲]** or **[▼]** button to select “on” (privacy on) or “oF” (privacy off).
- 3 Press the **[CALL]** button, the **[MON]** button, or the **[PTT]** switch to store the settings and return to normal operation.



TRANSMIT POWER

You can adjust the transmit power on each channels. Selecting low power will allow longer use of the battery pack. Selecting high power will allow you to transmit further, in case the other party is too far away for low power usage.

To change the transmit power:

- 1 Press the **[MENU]** button to enter Menu Mode. Use the **[MENU]** button to select Transmit Power setting mode.
 - The current setting blinks.
- 2 Press the **[▲]** or **[▼]** button to select “Lo” (low power) or “HI” (high power).
 - The **LOW** icon appears on the display when low power is selected.
- 3 Press the **[CALL]** button, the **[MON]** button, or the **[PTT]** switch to store the settings and return to normal operation.

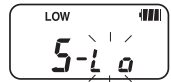
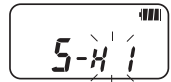

Note:

- ◆ The channel with fixed Low Power cannot be changed.
-

COMPANDER

The compander (compressor/expander) allows higher clarity of signals, avoiding excessive noise and interference. When activated, transmitted signals are compressed before being sent and received signals are expanded when they arrive.

- 1 Press the **[MENU]** button to enter Menu Mode. Use the **[MENU]** button to select Compander setting mode.
 - The current setting blinks.
- 2 Press the **[▲]** or **[▼]** button to select “CP-oF” (compander off) or “CP-o.n” (compander on).
- 3 Press the **[CALL]** button, the **[MON]** button, or the **[PTT]** switch to store the settings and return to normal operation.

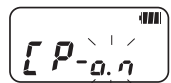
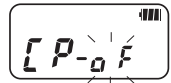

MONITOR

When no signals are present, the squelch on the transceiver automatically mutes the speaker so you will not hear background noise. Using the [MON] button, you can open the squelch to unmute the speaker. This allows you to:

- Confirm the channel activity so you don't make a call while another party is using the same channel.
- Adjust the volume level without having to wait for a call.
- Listen to an intermittent call (due to a weak signal) without it continuously cutting out.

To manually open the squelch, press and hold the [MON] button.

- When squelch is open, the  icon appears on the display and the LED lights green. To return to normal operation, release the [MON] button.

LOCK FUNCTION

KEY LOCK

You can lock [MENU], [▲], and [▼] buttons to prevent accidentally changing the operating mode and channel settings. The Power switch/ Volume control and [PTT] switch, [CALL], and [MON] buttons still function normally.

* The [CALL] button functions normally only if it has been set up as Call Alert.

Press and hold the [MENU] button for 3 seconds to lock or unlock the transceiver buttons.

- The  icon appears on the display when the transceiver buttons are locked. No icon appears when they are unlocked.

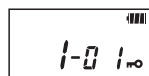

Example of PKT-300LF

SUPER LOCK

You can lock the [MENU], [CALL], [▲], and/or [▼] buttons, and disable the Setting Mode. The Power switch/ Volume control, [PTT] switch and [MON] buttons still function normally.

To select the super lock setting:

- 1 With the transceiver power OFF, press and hold the [PTT] switch and the [CALL] button while turning the transceiver power ON (for 1 second).
- 2 Press the [▲] or [▼] button to select "SL-P" ([MENU], [CALL], [▲], and [▼] buttons locked), "SL-C" ([MENU] and [CALL] buttons locked), or "SL-oF" (super lock off).
- 3 Press the [MENU], [PTT] switch, [MON], or [CALL] buttons to exit Super Lock Setting Mode.
 - The  icon appears on the display when the transceiver buttons are locked. No icon appears when they are unlocked.

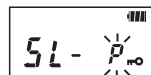
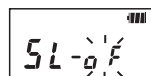

SETTING MODE

Many functions on this transceiver are selected or set via menus instead of physical controls.

- 1 With the transceiver power OFF, press and hold the **[MENU]** button while turning the transceiver power ON (for 1 second).
- 2 Press the **[▲]** or **[▼]** button to select setting item.
- 3 Press the **[MENU]** button to go into data setting.

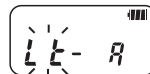

- 4 Press the **[▲]** or **[▼]** button to select setting data.

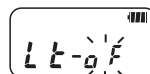

- 5 Press the **[MENU]** button again to go back to setting item selection.

Setting Menu for PKT-300 (LMR model)

Display	Setting Item	Setting Range	Default
CA	Call Alert Tone *1	Type 1 to 10	1
Lt	BackLight	Off/ On/ A (Auto)	A (Auto)
bt	Battery Level Indicator	Off/ On	On
bS	Battery Saver	Off/ On	Off
bP	Beep Tone	Off/ On	On
Sq	Squelch Level	0/ 1/ 2/ 3/ 4/ 5	2
GL	VOX Gain Level	Off/ 1 to 5	Off
dy	VOX Delay Time *2	0.3/ 0.5/ 1.0/ 1.5/ 2.0/ 3.0 sec	0.5 sec
tl	Transmit Inhibit while Receiving *2	Off/On	Off
Pd	VOX Proceed Tone *2	Off/On	Off
Co	VOX Cancel Operation *2	Off/On	Off
Po	Selectable Power On Tone	Type 1 to 3	1

*1: If Call Key is set to Off, this menu is skipped.

*2: If VOX Gain Level is set to Off, this menu is skipped.

Setting Menu for PKT-300LF (GMRS/FRS model)

Display	Setting Item	Setting Range	Default
1~16	CH1~16 Frequency Setting* ³	F0 to F22	F0(Off channel) the default QT/DQT is (010)94.8.
Ct	Incoming Call Notification	Off/ On	Off
CL	Call Key (press)	Off/ CA (Calling Alert) / LP(Low Transmit Power)	Off
CA	Call Alert Tone * ¹	Type 1 to 10	1
CS	Call Alert Side Tone	Off/ On	On
rt	Mode Reset Timer	Off / 10 / 30 sec	10 sec
to	Time-out Timer	1/ 2/ 3 to 10 min	1 min
bL	Busy Channel Lockout	Off/ CO/ CQ/ IQ	Off
Lt	BackLight	Off/ On/ A (Auto)	A (Auto)
bt	Battery Level Indicator	Off/ On	On
bS	Battery Saver	Off/ On	Off
bP	Beep Tone	Off/ On	On
SC	Scan Function	Off/ On	Off
Sq	Squelch Level	0/ 1/ 2/ 3/ 4/ 5	2
SE	Mic Sense	no (Normal)/ HI (High)	no (Normal)
GL	VOX Gain Level	Off/ 1 to 5	Off
dy	VOX Delay Time * ²	0.3/ 0.5/ 1.0/ 1.5/2.0/ 3.0 sec	0.5 sec
Co	VOX Cancel Operation * ²	Off/On	Off
tl	Transmit Inhibit while Receiving * ²	Off/On	Off
Pd	VOX Proceed Tone * ²	Off/On	Off
Po	Selectable Power On Tone	Type 1 to 3	1

*¹: If Call Key is set to Off, this menu is skipped.

*²: If VOX Gain Level is set to Off, this menu is skipped.

*³: When Channel Frequency Setting is set from F0 to other than F0 in Setting Mode, each channel setting is set to Default and QT/DQT is set to (010)94.8.

CHANNEL FREQUENCY SETUP

You can change the default frequency of each channel.

Note:

- ◆ In the LMR model, when your dealer has set up the channel table, the set channels can be used.

- 1 Enter the Setting Mode {page 16}.
- 2 Press the [**▲**] or [**▼**] button to select a channel.
 - The current frequency table number appears beside the channel number.
- 3 Press the [**MENU**] button then press the [**▲**] or [**▼**] button to select the frequency table number for the channel.
- 4 Press the [**MENU**] button to exit the selection, then repeat steps 2 and 3 to set additional channels.

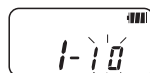

Channel Number table: PKT-300LF(GMRS/FRS model)

Table No.	RX Frequency [MHz]
0	Off
1	462.5625
2	462.5875
3	462.6125
4	462.6375
5	462.6625
6	462.6875
7	462.7125
8	467.5625
9	467.5875
10	467.6125
11	467.6375
12	467.6625
13	467.6875
14	467.7125
15	462.5500
16	462.5750
17	462.6000
18	462.6250
19	462.6500
20	462.6750
21	462.7000
22	462.7250

DEFAULT CHANNEL

The table below lists the default channel settings.

This transceiver allows to program each of the channels with different frequencies and QT/ DQT settings.

Default channel table: PKT-300LF(GMRS/FRS model)

Channel Number	(Table No.) RX Frequency [MHz]	TX PWR [W]	(Table No.) QT/DQT [Hz]
1	(01) 462.5625	2.0 (e.r.p.)	(10) 94.8
2	(02) 462.5875	2.0 (e.r.p.)	(08) 88.5
3	(03) 462.6125	2.0 (e.r.p.)	(13) 103.5
4	(04) 462.6375	2.0 (e.r.p.)	(05) 79.7
5	(05) 462.6625	2.0 (e.r.p.)	(17) 118.8
6	(06) 462.6875	2.0 (e.r.p.)	(18) 123.0
7	(07) 462.7125	2.0 (e.r.p.)	(19) 127.3
8	(15) 462.5500	2.0 (e.r.p.)	(07) 85.4
9	(16) 462.5750	2.0 (e.r.p.)	(14) 107.2
10	(17) 462.6000	2.0 (e.r.p.)	(15) 110.9
11	(18) 462.6250	2.0 (e.r.p.)	(16) 114.8
12	(19) 462.6500	2.0 (e.r.p.)	(06) 82.5
13	(20) 462.6750	2.0 (e.r.p.)	(20) D132N
14	(21) 462.7000	2.0 (e.r.p.)	(24) D155N
15	(22) 462.7250	2.0 (e.r.p.)	(21) D134N
16	(00)Off	-	-

INCOMING CALL NOTIFICATION (PKT-300LF ONLY)

Note:

- ◆ To use Incoming Call Notification, you must set up a QT tone or a DQT code {page 12}.

Incoming Call Notification is used to inform you of when a call is being received. When activated, a tone is emitted when a busy signal is received and the QT/ DQT signaling matches.

- The tone will sound for 15 seconds before turning off.
- While the tone sounds, you will not hear any audio from the speaker. Press any button to turn the tone off and listen to the received call.

After the call is finished, the transceiver will wait for 10 seconds before resetting. If you receive a new call within those 10 seconds, the tone will not sound. If no call is received within 10 seconds, Incoming Call Notification will reset so that the next time a call is received, the tone will sound again.

To turn Incoming Call Notification on or off:

- 1 Enter the Setting Mode {page 16}.
- 2 Press the [**▲**] or [**▼**] button to select “Ct”.
- 3 Press the [**MENU**] button then press the [**▲**] or [**▼**] button to select “Ct-oF” (incoming call notification off), or “Ct-on” (incoming call notification on).

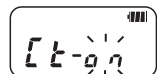
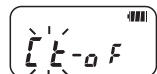

KEY ASSIGNMENT MODE (PKT-300LF ONLY)

This transceiver allows you to reprogram the **[CALL]** button with any of the functions listed in the table below. Explanations on the use of each function are provided under “PROGRAMMABLE FUNCTIONS”.

Table No.	Function Name
oF	Off (no function)
CA	Calling Alert
LP	LOW Transmit Power

Set the function to be used by press the **[CALL]** button:

- 1 Enter the Setting Mode {page 16}.
- 2 Press the [**▲**] or [**▼**] button to select “CL”.
- 3 Press the **[MENU]** button then press the [**▲**] or [**▼**] button to select “CL-oF” (Key assignment is off), “CL-CA” (Calling Alert is on), or “CL-LP” (LOW Transmit Power is on).

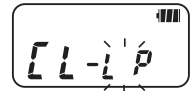
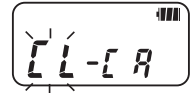

Programmable Functions

Off	Disables the [CALL] button. Key Error Tone sounds if the [CALL] button is pressed.
Calling Alert	Press the [CALL] button to call another transceiver by using an individual Call Alert Tone.
LOW Transmit Power	Press the [CALL] button, the transmit power of all channels can be changed to Low Transmit Power.

CALL ALERT TONE

Call alert tones are used to identify yourself to your party members. You can set up a call alert tone to one of 10 types. If each party member uses a different call alert tone, it is easy to know who is making the call. Pressing the **[CALL]** button before making a call will send your call alert tone to your party members.

To set up your own call alert tone:

- 1 Enter the Setting Mode {page 16}.
- 2 Press the **[▲]** or **[▼]** button to select “CA”.
- 3 Press the **[MENU]** button then press the **[▲]** or **[▼]** button to select “CA - 1” (call alert tone 1) to “CA - 10” (call alert tone 10).

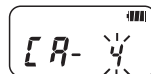
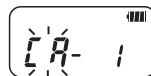

- Each time you press the **[▲]** or **[▼]** button to select a call alert tone, the new tone sounds.

CALL ALERT SIDE TONE (PKT-300LF ONLY)

When the **[CALL]** button is pressed, the call alert tone will sound through your own speaker as well.

To turn the Call Alert Side Tone on or off, on your own transceiver:

- 1 Enter the Setting Mode {page 16}.
- 2 Press the **[▲]** or **[▼]** button to select “CS”.
- 3 Press the **[MENU]** button then press the **[▲]** or **[▼]** button to select “CS - on” (Call Alert Side Tone is on) or “CS - oF” (Call Alert Side Tone is off).

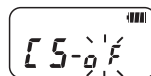
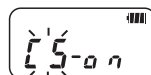

Individual Calls:

For example, transceiver A is calling transceiver E.

- 1 Press the **[CALL]** button.
- 2 Press the **[▲]** or **[▼]** button to select an individual ID number (Id-05 in this example).
 - “Id” (individual call) represents a single station.
- 3 Press the **[PTT]** switch to transmit the selected ID.
 - When a call is received, “Id” appears on the display, along with the caller’s ID number.

MODE RESET TIMER (PKT-300LF ONLY)

This function returns the transceiver to the channel display after a preset timer expires while in Menu mode.

To set the mode reset timer:

- 1 Enter the Setting Mode {page 16}.
- 2 Press the [**▲**] or [**▼**] button to select “rt”.
- 3 Press the [**MENU**] button then press the [**▲**] or [**▼**] button to select “rt - oF” (timer off), “rt - 10” (10 seconds), “rt - 30” (30 seconds).

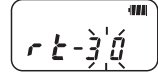
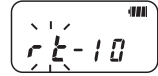

TIME-OUT TIMER (PKT-300LF ONLY)

The Time-out Timer prevents you from using a channel for an extended duration. This function is useful, for example, when you accidentally keep the [**PTT**] switch pressed. Additionally, by limiting the amount of time you can continuously transmit, this function helps you save on battery power consumption.

If you continuously transmit for 60 seconds, the transceiver will stop transmitting and a tone will sound. To stop the tone, release the [**PTT**] switch. You can press the [**PTT**] switch again to resume transmitting.

To change the default value of 1 minute:

- 1 Enter the Setting Mode {page 16}.
- 2 Press the [**▲**] or [**▼**] button to select “to”.

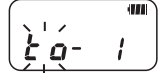

- 3 Press the [**MENU**] button then press the [**▲**] or [**▼**] button to select “to-1” (1 minute) or “to-10” (10 minutes) by 1 minute steps.

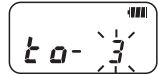

This transceiver is also equipped with a pre-alert tone which sounds 10 seconds before the Time-out Timer expires. This will allow you time to finish your message before the transceiver automatically stops transmitting.

BUSY CHANNEL LOCKOUT (BCL) (PKT-300LF ONLY)

This function is used in order to prevent transmitting on a channel that somebody else is currently using. When turned ON, a beep sounds when you press the [PTT] switch while another party is using the channel, and you cannot transmit.

To turn BCL on or off:

- 1 Enter the Setting Mode {page 16}.
- 2 Press the [▲] or [▼] button to select "bL".
- 3 Press the [MENU] button then press the [▲] or [▼] button to select "bL-oF" (BCL Off), "bL-Co" (BCL Carrier Only), "bL-Cq" (BCL Correct QT/DQT), or "bL-lq" (BCL InCorrect QT/DQT).

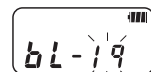
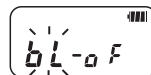

- BCL Off :** Disable the BCL function.
- BCL Carrier Only :** A user cannot start transmitting while receiving a carrier.
- BCL Correct QT/DQT:** A user cannot start transmitting while a carrier with the correct QT tone or DQT code is detected on the channel. However, the transceiver is allowed to transmit if the QT tone or DQT code is incorrect.
- BCL InCorrect QT/DQT:** A user cannot start transmitting while a carrier with the incorrect QT tone or DQT code is detected on the channel. However, the transceiver is allowed to transmit if the QT tone or DQT code is correct.

BACKLIGHT

You can set the display backlight to remain off, remain on, or turn on when you press any button other than the [PTT] switch (auto). When set to auto, the backlight remains on for 5 seconds after pressing a button, before turning off again.

To select the backlight setting:

- 1 Enter the Setting Mode {page 16}.
- 2 Press the [▲] or [▼] button to select "Lt".
- 3 Press the [MENU] button then press the [▲] or [▼] button to select "Lt -oF" (backlight off), "Lt - on" (backlight on), or "Lt - A" (backlight auto).

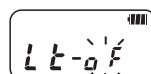
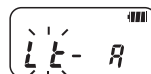

BATTERY LEVEL INDICATOR

When turned ON, the battery level indicator on the display lets you know approximately how much battery life is remaining. When turned OFF, the battery level indicator will not be displayed.

When the battery voltage becomes too low while transmitting, the transceiver stops transmitting, a tone sounds, and the LED blinks red until you release the **[PTT]** switch. Recharge or replace the battery pack at this time.

- ▣▣▣▣ High battery power
- ▣▣▣ Medium battery power
- ▣▣ Low battery power
- ▣ Recharge the battery pack

To turn this function on or off:

- 1 Enter the Setting Mode {page 16}.
- 2 Press the **[▲]** or **[▼]** button to select “bt”.

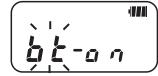

- 3 Press the **[MENU]** button then press the **[▲]** or **[▼]** button to select “bt - on” (battery level indicator on) or “bt - oF” (battery level indicator off).

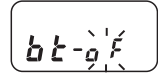

BATTERY SAVER

This transceiver has been designed to give you the most out of your battery power. The battery saver function decreases the amount of power used when a signal is not being received and no operations are being performed.

While using the transceiver, battery saver will automatically switch ON after 5 seconds have elapsed with no operations or received calls. Operating the transceiver or receiving a call will switch this function OFF until 5 seconds of non-operation occurs again.

To turn this function on or off:

- 1 Enter the Setting Mode {page 16}.
- 2 Press the **[▲]** or **[▼]** button to select “bS”.

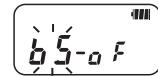

- 3 Press the **[MENU]** button then press the **[▲]** or **[▼]** button to select “bS - on” (battery saver on) or “bS - oF” (battery saver off).

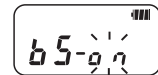

Note:

- ◆ While the Battery Saver is operating, the LED may flash green when receiving a QT/DQT signal which does not match the QT/DQT tone/code set up in your transceiver.

BEEP TONE

When you press a button, a beep will emit from the transceiver.

To turn the beep tone on or off:

- 1 Enter the Setting Mode {page 16}.
- 2 Press the [**▲**] or [**▼**] button to select “bP”.
- 3 Press the [**MENU**] button then press the [**▲**] or [**▼**] button to select “bP - on” (beep tone on) or “bP - oF” (beep tone off).

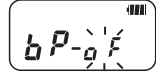
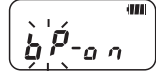

SCAN (PKT-300LF ONLY)

Scan is useful for monitoring signals on the transceiver channels. When scanning, the transceiver checks for a signal on each channel and only stops if a signal is present.

If the QT/DQT matches, the transceiver stops at the channel and opens the squelch so you can listen to the call. If the QT/DQT does not match, the call is ignored and scanning continues.

Before you can use the scan function, ensure that it is activated. You can turn the scan function (the ability to perform scan) ON or OFF in Setting Mode.

- 1 Enter the Setting Mode {page 16}.
- 2 Press the [**▲**] or [**▼**] button to select “SC”.
- 3 Press the [**MENU**] button then press the [**▲**] or [**▼**] button to select “SC-oF” (scan function disabled) or “SC-on” (scan function enabled).

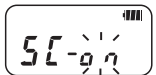
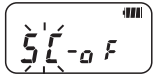

- If you select “SC -oF”, you will no longer be able to perform scan by pressing and holding the [**▲**] button.

To begin scanning:

- 1 Press and hold the [**▲**] button for 1 second.
 - “SC An” appears on the display.
- 2 When a signal is detected and the QT/ DQT matches, the channel number appears on the display and blinks.
- 3 When the signal is no longer present, the transceiver waits for 5 seconds before scanning continues.
 - If a new signal appears before the 5 seconds elapse, the transceiver will remain on the channel until the new signal is no longer present, at which time it will again wait for 5 seconds before continuing.
- 4 To end the scan at any time, press and hold the [**▲**] button for 1 second.
 - The transceiver returns to the channel you were using before you started scanning.

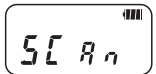

REVERT CHANNEL

The revert channel is the channel from which you start scanning. So, for example, if you are on channel 1 when you begin to scan, your revert channel is channel 1.

During scan, pressing the [PTT] switch will automatically select the transceiver's revert channel (in the above example, channel 1) and you will begin transmitting. However, if you are currently paused on another channel after having received a signal (for example, channel 2), pressing the [PTT] switch will allow you to transmit on that channel, rather than returning to the revert channel. Scanning will resume after 5 seconds, unless a signal is present on the channel.

SQUELCH LEVEL

You can adjust the default squelch level of the transceiver.

- 1 Enter the Setting Mode {page 16}.
- 2 Press the [▲] or [▼] button to select "Sq".
- 3 Press the [MENU] button then press the [▲] or [▼] button to select "Sq - 0" (open), "Sq - 1", "Sq - 2" (default setting), "Sq - 3", "Sq - 4", or "Sq - 5" (tight).

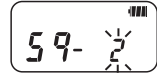
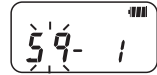

MIC SENSE (PKT-300LF ONLY)

You can adjust the sensitivity level of the transceiver microphone.

To select the mic sense:

- 1 Enter the Setting Mode {page 16}.
- 2 Press the [▲] or [▼] button to select "SE".
- 3 Press the [MENU] button then press the [▲] or [▼] button to select "SE - no" (normal) or "SE - HI" (high).

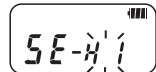
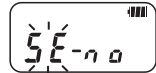

VOICE OPERATED TRANSMISSION (VOX)

Using the VOX function, you can operate the transceiver hands-free. In order to use this function, however, you must use an optional headset; VOX will not function with the built-in microphone. For best operation conditions, we recommend you use an optional headset with both an earpiece and a microphone on a boom that rests in front of your mouth.

VOX OPERATION

- 1 To activate the VOX function, set the VOX GAIN LEVEL.
- 2 To transmit, speak into the headset microphone.
 - You do not need to press the **[PTT]** switch; the transceiver automatically detects your voice and begins transmitting. The LED lights red.
- 3 To stop transmitting, stop speaking.
 - Transmission will continue momentarily after you stop speaking. You can select the delay time as described on VOX Delay Time.

VOX GAIN LEVEL

With VOX activated, your voice level will determine when you transmit. Due to the automatic switching between transmission and reception, we recommend you set the VOX gain level such that it will not activate when in an area with excessive ambient noise.

- 1 Enter the Setting Mode {page 16}.
- 2 Press the **[▲]** or **[▼]** button to select “GL”.
- 3 Press the **[MENU]** button then press the **[▲]** or **[▼]** button to select “GL-oF” (VOX function off) or “GL- 1” (VOX gain level 1) to “GL- 5” (VOX gain level 5).

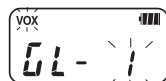
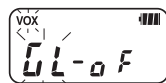

- VOX Gain level 1 is the least sensitive and VOX Gain level 5 is the most sensitive.
- While adjusting the VOX Gain level, speak into the microphone. When an appropriate level is reached, the LED lights orange.
- Setting the VOX gain level to OFF deactivates VOX. In order to transmit with VOX turned off, you must use the **[PTT]** switch.

VOX DELAY TIME

If the transceiver returns to receive mode too quickly after you stop speaking, the end of your message may not be transmitted. To avoid this, select an appropriate delay time that allows your entire message to be transmitted. However, do not make the delay overly long.

- 1 Enter the Setting Mode {page 16}.
- 2 Press the **[▲]** or **[▼]** button to select “dy”.
- 3 Press the **[MENU]** button then the **[▲]** or **[▼]** button to select “dy 0.3” (0.3 sec.), “dy 0.5” (0.5 sec.), “dy 1.0” (1 sec.), “dy 1.5” (1.5 sec.), “dy 2.0” (2 sec.), or “dy 3.0” (3 sec.).

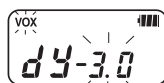
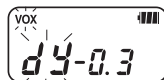

- While adjusting the VOX Delay Time, speak into the microphone to simulate transmitting. The LED lights orange while speaking, but no signal is transmitted at this time.

VOX CANCEL OPERATION

You can set the transceiver to pressing the [PTT] switch, you can set whether or not the VOX function is automatically disabled.

When this function is ON, the radio transmits when the [PTT] switch is pressed; after the [PTT] switch, VOX is disabled.

The VOX function can also be enabled by turning the transceiver power OFF and ON again.

When this function is OFF, pressing the [PTT] switch will transmit; VOX is still enabled.

- 1 Enter the Setting Mode {page 16}.
- 2 Press the [▲] or [▼] button to select “Co”.
- 3 Press the [MENU] button then press the [▲] or [▼] button to select “Co-oF” (VOX cancel operation off) or “Co-on” (VOX cancel operation on).

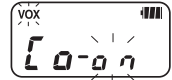
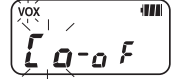

TRANSMIT INHIBIT WHILE RECEIVING

While using VOX, you can set the transceiver to detect when the channel is in use (in place of using the Monitor function). With this function turned on, VOX will not allow you to transmit while the channel is being used. You can transmit only when the channel is free. Setting up the proceed tone function will notify you when the channel is free.

- 1 Enter the Setting Mode {page 16}.
- 2 Press the [▲] or [▼] button to select “t I”.
- 3 Press the [MENU] button then the [▲] or [▼] button to select “t I-oF” (transmit inhibit while receiving off) or “t I-on” (transmit inhibit while receiving on).

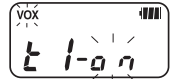
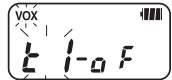

VOX PROCEED TONE

You can set the transceiver to sound an alert tone when you are able to transmit (transmission is no longer inhibited).

- 1 Enter the Setting Mode {page 16}.
 - 2 Press the [▲] or [▼] button to select “Pd”.
 - 3 Press the [MENU] button then press the [▲] or [▼] button to select “Pd-oF” (VOX proceed tone off) or “Pd-on” (VOX proceed tone on).
- You can speak into the microphone at this time to simulate transmitting. The LED lights orange while speaking if your voice is at an appropriate level, but no signal is transmitted at this time.

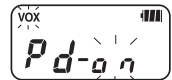
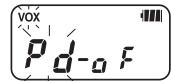

SELECTABLE POWER ON TONE

You can set up a tone to sound during power on to one of 3 types.

To set the power on tone type:

- 1 Enter the Setting Mode {page 16}.
- 2 Press the [**▲**] or [**▼**] button to select “Po”.
- 3 Press the [**MENU**] button then press the [**▲**] or [**▼**] button to select “Po - 1” (type 1), “Po - 2” (type 2), “Po - 3” (type 3).

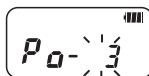
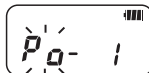

RESETTING THE TRANSCEIVER (PKT-300LF ONLY)

At some point in time, you may desire to reset the transceiver settings to their default values. This function will reset all channels to their default frequencies and QT/DQT, the VOX function to its default status, and all buttons to their default functions.

To reset the transceiver:

- 1 With the transceiver power OFF, press and hold the [**MON**] button, the [**▲**] button, and the [**▼**] button while turning the transceiver power ON.
 - The transceiver displayed "rEst".
- 2 Release the buttons.
 - The transceiver displayed "SuRE".
- 3 Press the [**PTT**] switch.
 - The transceiver starts All Reset.
 - After the reset completed , returns to normal operation.
 - If a button other than the [**PTT**] switch is operated, All Reset will not be performed and the data is returns to normal operation.

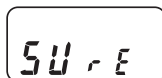
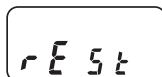

OPTION

The following options are available for use with this transceiver.

Model Name	Contents
KBH-23	Belt Clip Holster
KBH-14	Belt Clip
KBH-20	Belt Clip
KBH-21	Belt Clip
KNB-81L	Li-ion Battery Pack
KMC-21A	Speaker Microphone
KMC-45D	Speaker Microphone
EMC-11	Clip Microphone with Earphone
EMC-12	Clip Microphone with Earphone
KHS-35F	Headset
KSC-50CR	Charger Pocket
KSC-44SL	AC Adapter (Single)
KSC-44ML	AC Adapter (Multiple)
KHS-7/7C	Single-Muff Headset
KHS-7A/7AC	Single-Muff Headset w/ In-line PTT
KHS-8BL	2-wire Palm Mic w/ Earphone
KHS-9BL	3-wire Palm Mic w/ Earphone
KHS-10D-BH	Heavy-duty Behind the Headset
KHS-10D-OH	Heavy-duty Over the Headset
KHS-22A	Headset w/ VOX & PTT
KHS-26	Earbud In-line PTT Headset
KHS-27A	D-Ring In-line PTT Headset
KHS-31C	C-Ring Ear Hanger w/ PTT& Mic
KEP-2	Earphone Kit for KMC-21A

TROUBLESHOOTING GUIDE

Problem	Solution
Cannot turn the transceiver power ON.	<ul style="list-style-type: none"> The battery pack may be dead. Recharge or replace the battery pack. The battery pack may not be installed correctly. Remove the battery pack and install it again.
Battery power dies shortly after charging.	<ul style="list-style-type: none"> The battery pack life is finished. Replace the battery pack with a new one.
Cannot talk to or hear other members in your group.	<ul style="list-style-type: none"> Make sure you are using the same frequency and QT/DQT setting as the other group members. Other group members may be using Privacy Talk. Turn on your transceiver's Privacy Talk. Other group members may be too far away. Make sure you are within range of the other transceivers.
Other voices (besides group members) are present on the channel.	<ul style="list-style-type: none"> Change the QT/DQT settings. Make sure all group members change the settings on their transceivers to match the new QT/DQT setting.
The transceiver is malfunctioning for no apparent reason.	<ul style="list-style-type: none"> Reset the transceiver as described on {page 29}.

SPECIFICATIONS

RF output power	High	2.0 W
	Low	0.5 W
Audio output power		100 mW
Frequency stability		± 2.5 ppm
Operating voltage		3.8 V
Dimensions (W x D x H) (projection not included)		50 x 27 x 98 mm
Weight (with KNB-81L)		140 g

Specifications are subject to change without notice, due to advancements in technology.

KENWOOD

© 2025 JVCKENWOOD Corporation