



mini

QUADCOPTER DRONE

USER'S GUIDE FOR MODEL DR177 V1760-01

Warnings & Precautions

Important Safety Instructions

- Read and follow all instructions.
- Keep these instructions for future reference.
- Heed all Warnings.
- Intended for children ages 14 and higher. Adult supervision is required.
- Only use attachments/accessories specified by the manufacturer.
- Before flying, always check the body, rotors, and battery for any damage or obstructions.
- Battery should be free from cracks or swelling.
- Keep the rotors clear of any obstructions and body parts to avoid potential damage and injury.
- Manufacturer and dealer assume no liability for accidental damages from improper use or installation of parts, or from damage incurred from worn or broken parts.
- Pilots are responsible for their actions and any damage caused from improper use.
- Pilots should keep the craft in sight at all times during flight. If you lose sight of the craft at any time, power down and cease flight immediately.
- Only fly in large, open areas that are free from obstacles or potential hazards, such as trees, power lines, ceiling fans, and the like.
- Flying over bodies of water is not recommended.
- Flying at night is not recommended.
- Never try to retrieve the craft from areas you cannot safely reach, such as rooftops or trees.
- Never launch the craft from your hand.
- Never leave the craft unattended while it is powered on or while the battery is charging.

FCC Warnings

Warning: Changes or modifications to this unit not expressly approved by the party responsible for compliance could void the user's authority to operate the equipment.

NOTE: This equipment has been tested and found to comply with the limits for a Class B digital device, pursuant to Part 15 of the FCC Rules. These limits are designed to provide reasonable protection against harmful interference in a residential installation. This equipment generates, uses, and can radiate radio frequency energy and, if not installed and used in accordance with the instructions, may cause harmful interference to radio communications. However, there is no guarantee that interference will not occur in a particular installation. If this equipment does cause harmful interference to radio or television reception, which can be determined by turning the equipment off and on, the user is encouraged to try to correct the interference by one or more of the following measures:

- Reorient or relocate the receiving antenna.
- Increase the separation between the equipment and receiver.
- Connect the equipment into an outlet on a circuit different from that to which the receiver is connected.
- Consult the dealer or an experienced radio/TV technician for help.

Additional Warnings & Precautions

- **WARNING:** To reduce the risk of fire or electric shock, do not expose this apparatus to rain, moisture, dripping, or splashing.
- **CAUTION:** Use of controls or adjustments or performance of procedures other than those specified may result in personal injury.
- **WARNING:** Changes or modifications to this unit not expressly approved by the party responsible for compliance could void the user's authority to operate the equipment.
- **CAUTION:** Danger of explosion if battery is incorrectly replaced. Replace only with the same or equivalent type.
- Lithium batteries, like all rechargeable batteries, are recyclable and should be recycled or disposed of according to state and local guidelines. They should never be disposed of in normal household waste, and they should never be incinerated, as they might explode. Contact your local government for disposal or recycling practices in your area.
- **WARNING:** Shock hazard - Do Not Open. Battery shall not be exposed to excessive heat such as sunshine, fire, or the like. Keep new and used batteries away from children. If the battery compartment does not close securely, stop using the product and keep it away from children.
- If you think batteries might have been swallowed or placed inside any part of the body, seek immediate medical attention.
- Do not mix old and new batteries.
- Completely replace all old batteries with new ones.
- Do not mix alkaline, standard (carbon-zinc), or rechargeable (ni-cad, ni-mh, etc) batteries.
- Batteries should be recycled or disposed of as per state and local guidelines.
- **WARNING:** This product may contain chemicals known to the State of California to cause birth defects, or other reproductive harm (California Prop 65). Wash hands after handling.
- This product meets and complies with all Federal regulations.

Table of Contents

Sky Rider Hawk – 5

Features
Includes

Overview – 6

Craft Layout & Features
Remote Control

Batteries & Charging – 8

Battery Charging Procedure
Remote Control Batteries

Flying – 10

Craft/Remote Link

Trim Adjustment – 12

Setting Trim & Countering Drift
Factory Reset

Flying Tips & Features – 14

Tips for Safe Operation
Speed Setting
Flips & Tricks

Repair – 16

Rotor Replacement

Troubleshooting – 17

Customer Support – 18

Contact Information
International Support
Warranty

SkyRider Mini Drone

FEATURES

- 360° flips & tricks
- 6-axis gyroscope
- 3 speeds: low, medium, high
- Control distance: up to 65 feet
- LED navigation lights
- Operating time: 5-7 minutes
- Charge time: 40-50 minutes

INCLUDES

- 2.4 GHz remote control: requires 2 AA batteries (not included)
- Built-in rechargeable lithium-polymer battery
- USB cable for battery recharge
- 4 replacement rotors
- User's guide & warranty



Overview

CRAFT LAYOUT & FEATURES

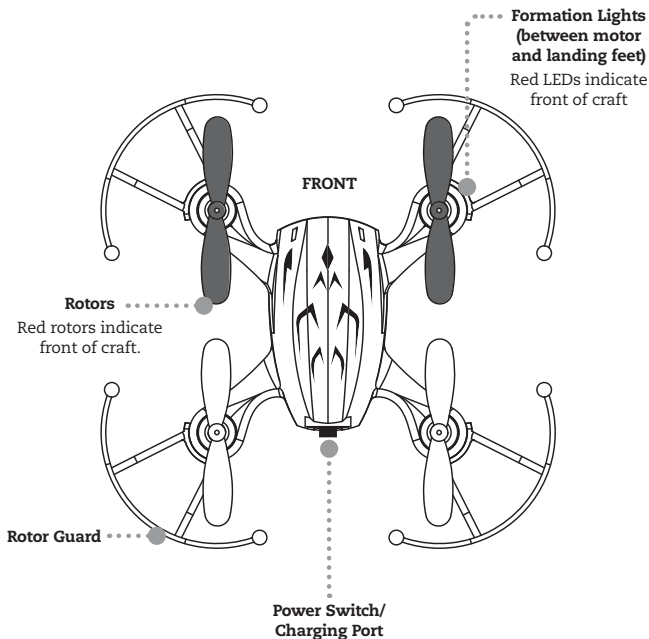

REMOTE CONTROL

Flight Control Speed

Press to craft speed.

Flip/Reset

Press once, then move Right Control Stick to perform a flip.

Press and hold to restore to default settings.

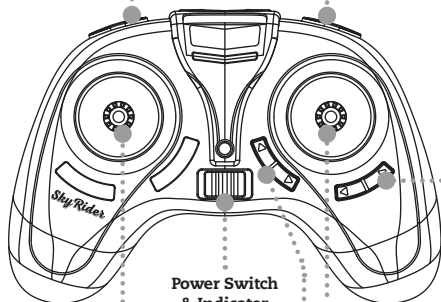

Power Switch & Indicator Light

Left Control Stick

Increase Throttle:

push forward

Decrease Throttle:

pull backward

Yaw/Spin:

push left or right

Pitch Adjustment

Correct forward/
backward drift.

Roll Adjustment

Correct left/right drift.

Right Control Stick

Pitch:

push forward/backward

Roll/Bank:

push left/right

Batteries & Charging

BATTERY CHARGING PROCEDURE

The craft's battery must be charged before the unit can be flown. **Before charging, be sure the craft and remote control are powered OFF.** Failure to do so may result in injury or damage.

Connect the charging cable (included) to the USB port of a powered ON computer or USB power adapter (not included), then connect the charging plug to the unit. **Be sure to correctly match the plug to the charging port or damage may occur.**

Charge fully before use for maximum performance and flight time. Charging time is approximately 40 to 50 minutes.

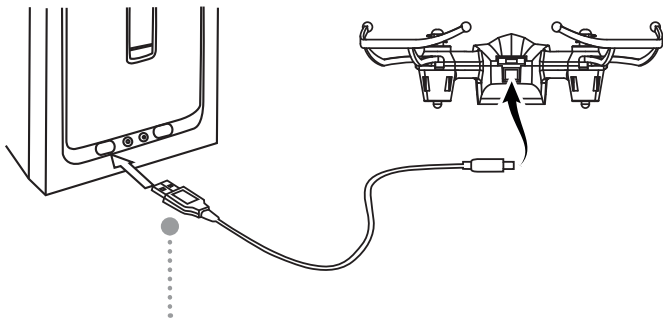

CHARGE STATUS	INDICATOR LIGHT
Unit is charging	ON
Charging complete	OFF

REMOTE CONTROL BATTERIES

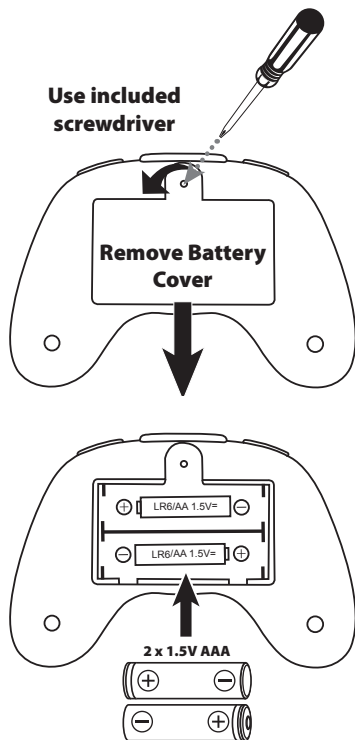

Flying

CRAFT/REMOTE LINK

Before flying, the craft and the remote must be linked together and the gyroscopes on the craft must be allowed to calibrate.

Begin with the craft and remote powered off.

STEP 1

Place the craft on a flat, level surface.

This is necessary for the craft's gyroscopes to properly align.

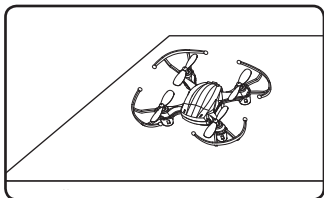

STEP 2

Power the craft ON. The LED formation lights will blink in unison as the craft searches for a signal from the remote.

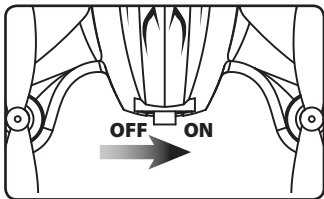

STEP 3

Power the remote control ON. The light on the remote will blink as it searches for the signal from the craft.

An audible chime will sound when the remote and the craft have linked with each other.

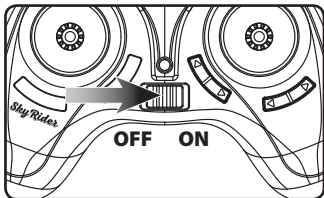

STEP 4

Push the **Left Control Stick** directly forward, then backward.

A chime will sound when the craft is calibrated and ready to fly.

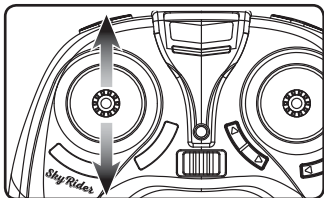

STEP 5

Push the **Left Control Stick (throttle)** forward to take off. Use both thumbsticks to control the craft.

If you notice a tendency to drift, you may need to adjust the trim controls to fine tune the handling (see next section).

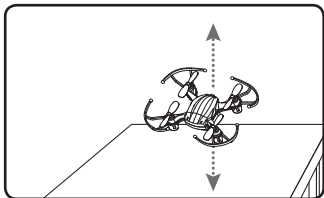

WHEN YOU'RE DONE FLYING...

After safely landing, keep the **Left Control Stick (throttle)** in the lowest position (OFF) and **power OFF the remote.**

Power OFF the remote first to make sure that no signals are accidentally sent to the craft. This will reduce the chance of injury. After the remote is powered OFF, it is safe to pick up and power OFF the craft.

Trim Adjustment

SETTING TRIM & COUNTERING DRIFT

Adjusting the trim settings to correct drift and provide better control of the craft.

To avoid potential damage, adjust the trim while attempting a stable hover. Try to avoid making any exaggerated movements with the flight controls and adjust one trim setting at a time to avoid confusion.

Remember, the red rotors/red LEDs indicate the front of the craft.

While adjusting the trim will help with drift, it is not guaranteed to eliminate it entirely. The small size of this craft makes it especially susceptible to environmental conditions or damage (ex: a gust of air or a bent rotor).

Craft **banks/rolls** to the left or right.

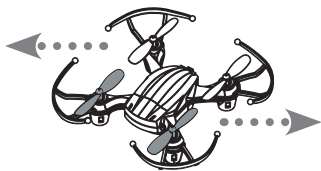

Front

Adjust **Roll Trim**.

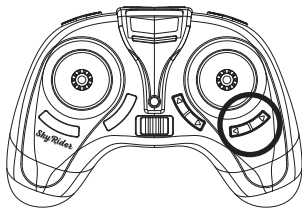

Craft **pitches/angles** forward or backward.

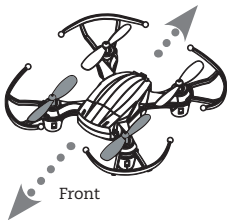

Front

Adjust **Pitch Trim**.

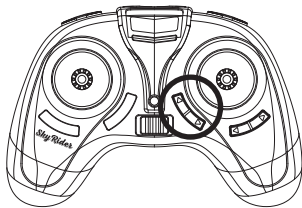

FACTORY RESET

If the craft is still experiencing difficulty flying or is behaving erratically, the craft and remote may need to be reset to factory default settings.

Be sure that the remote and craft are linked and begin on a flat level surface. Perform the reset by **pressing and holding the Reset/Flip button** until the LED lights start to blink. The LED formation lights will blink while the craft resets, when the blinking has stopped the craft is reset and ready to fly.

Do not attempt to perform the reset procedure while the craft is in the air.

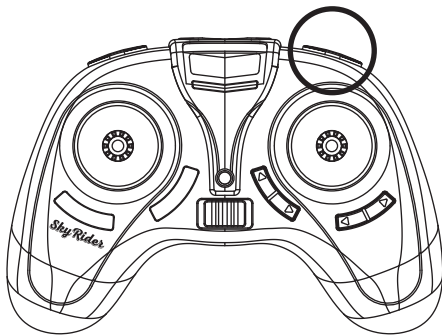

Flying Tips & Features

TIPS FOR SAFE OPERATION

- Only fly in large, open spaces free of obstacles like power lines, trees, ceiling fans, etc.
- It is best to fly 2 to 3 ft. from the ground and any obstacles. Flying low to the ground directs turbulence from the rotors back towards the craft, making it more difficult to control. Avoid walls and ceilings, as the craft may be drawn towards them if closer than 2 to 3 feet.
- Stand behind the craft when first taking off, so that you and the craft are facing the same “forward” direction. This will make it easier to know which direction the unit is flying.
- Practice basic flight operations like take off, hovering and landing.
- Novice pilots should move the controls slowly and deliberately, using one control at a time, to get used to the craft’s flying characteristics.
- If you crash, throttle down the engines IMMEDIATELY to reduce the chance of permanent damage to the craft and other objects.
- If anything obstructs the rotors for any reason, throttle down IMMEDIATELY and safely clear the obstruction. Check for possible damage before flying again.

SPEED SETTING

The craft has three settings for the responsiveness of the flight controls. The higher settings allow for faster and more precise control of the craft. Novice pilots are recommended to start with the lowest setting.

Press the **Speed Setting button** once to set the desired speed.

- **Low:** Gives smooth and predictable control. The remote will chime once to indicate the speed.
- **Medium:** The craft will move and respond faster to all control inputs. The remote will chime twice to indicate the speed.
- **High:** Highest setting for maximum performance. The remote will chime three times to indicate the speed.

FLIPS & TRICKS

Before attempting any stunts, be sure that there is ample clear space around the craft, ideally 3 to 5 ft.. in every direction. It is not recommended to attempt to flip around or through any obstacles, as this may result in unintended damage.

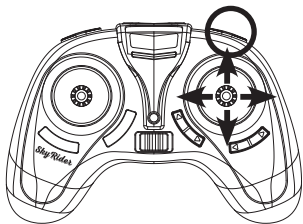

Press the **Flip button once**, then move the **Right Control Stick** in any direction.

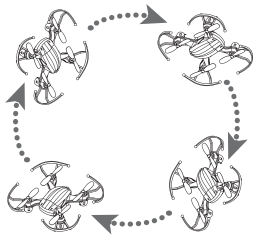

Craft will perform flip in the desired direction.

Repair

REMINDER: Pilots are responsible for any damage caused by improper use.

ROTOR REPLACEMENT

To replace a rotor, gently pull it upwards and off of the motor shaft and replace it with a new one. Take special care not to bend or break the motor shaft. If the rotors are difficult to remove by hand, try a small set of tweezers or pliers.

It is extremely important to use the correct rotor, A or B, for replacement.

The marking can be seen on the top of the rotor near the center cap. Using the incorrect rotor will make the craft impossible to control.

The craft comes with 4 replacement rotors, 2 A-type and 2 B-type.

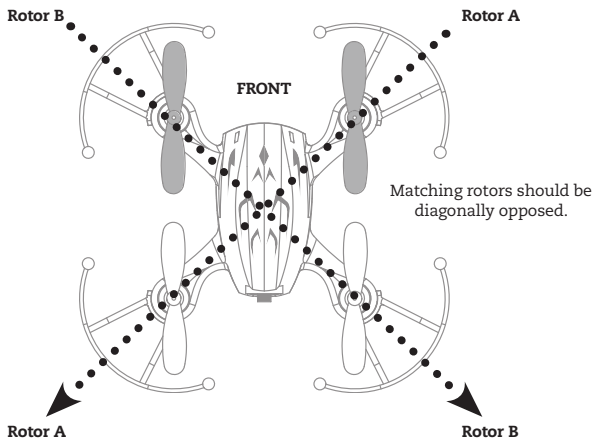

Troubleshooting

If you are experiencing problems using or flying the craft, consult this table.

PROBLEM	POSSIBLE CAUSES	SOLUTION
Craft does not respond to controls.	<ul style="list-style-type: none">• No power to remote or craft.• Craft is out of receiver range.	<ul style="list-style-type: none">• Check remote batteries, replace if needed.• Check craft's battery, charge if needed.• Be sure the remote has an unobstructed line of sight to the craft.• Remain within the remote's 65 ft. range.
Craft is difficult to control or flies erratically.	<ul style="list-style-type: none">• Gyroscopes may be misaligned.	<ul style="list-style-type: none">• Power OFF, recalibrate remote and craft (see pg. 10).
Craft drifts while in flight.	<ul style="list-style-type: none">• Trim not set or needs adjustment.	<ul style="list-style-type: none">• Adjust trim settings (see pg. 12).
Craft suffers from mechanical trouble.	<ul style="list-style-type: none">• Damage to body, rotors, or other major components.	<ul style="list-style-type: none">• Repair or replace parts as needed.
LED lights ON but craft does not respond to controls.	<ul style="list-style-type: none">• Low battery power.	<ul style="list-style-type: none">• Recharge the battery.

Customer Support

CONTACT INFORMATION

Website: www.gpx.com

Email Support: prodinfo@dpiinc.com

Email Parts: partsinfo@dpiinc.com

Phone Support: 1-888-999-4215

WARRANTY

See included 30 Day Warranty for warranty information. Warranty and the most up-to-date version of this User's Guide can also be found at: <http://gpx.com/dr177.html>

INTERNATIONAL SUPPORT

To download this User's Guide in English, Spanish, and French, or to get answers to frequently asked questions, visit the support section at: www.gpx.com

Para descargar este Manual del Usuario en inglés, español y francés, o para obtener respuestas a preguntas frecuentes, visite la sección de apoyo en: www.gpx.com

Pour télécharger ce guide de l'utilisateur en anglais, espagnol ou français, ou pour obtenir des réponses à des questions fréquemment posées, consultez la rubrique d'assistance sur: www.gpx.com



***Protect for Today
Sustain for Tomorrow***

Copyright © 2016 Digital Products International (DPI, Inc.) All other trademarks appearing herein are the property of their respective owners. Specifications are subject to change without notice.

