

81002-Dimensional drawing

Installation

1. Slide washer onto underside of soap base.

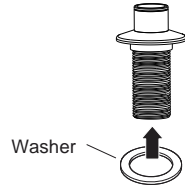

2. Insert soap base through sink or countertop hole.

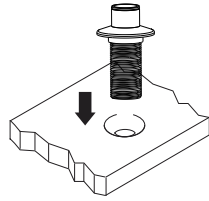

3. Install a washer from the sink or under the countertop and tighten the nut to the soap base.

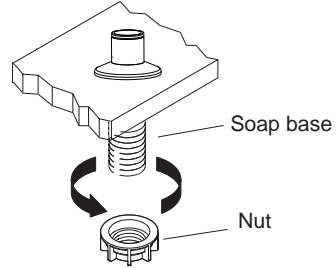

4. Thread bottle into soap base until hand-tight.

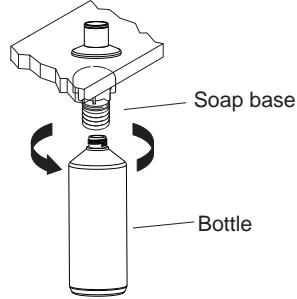

5. Fill the bottle with soap/lotion.
Note: each liquid supplement should not exceed 14OZ(about 400ml).

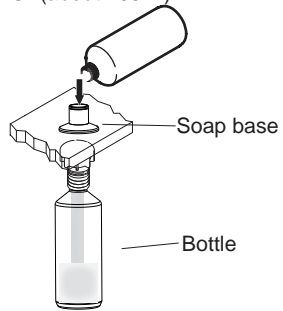

6. Insert blunt end of tube into soap pump.

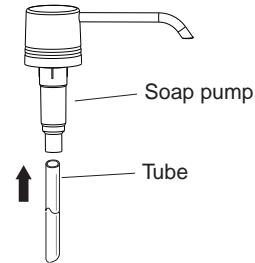

7. Insert the soap pump into the base, and the soap pump can start to work. The first use of the soap pump requires continuous pressure of 3 to 5 times, until there is liquid outflow.

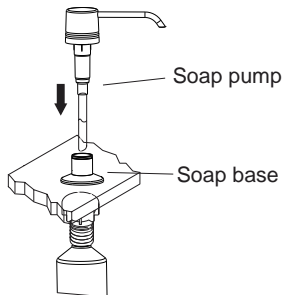

Replenish liquid:

Remove the soap pump and repeat steps 5 and 7.

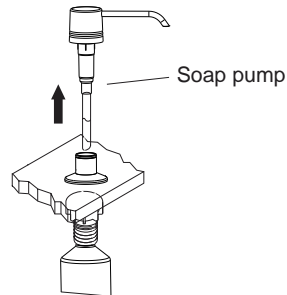

AKICON

Sink Soap Dispenser

PACKING LIST

After you open this package, please check to ensure that all of the following items are included.

A- Soap pump B- Soap base C- Washer
D- Tube E- Bottle F- Mounting Nut + Washer

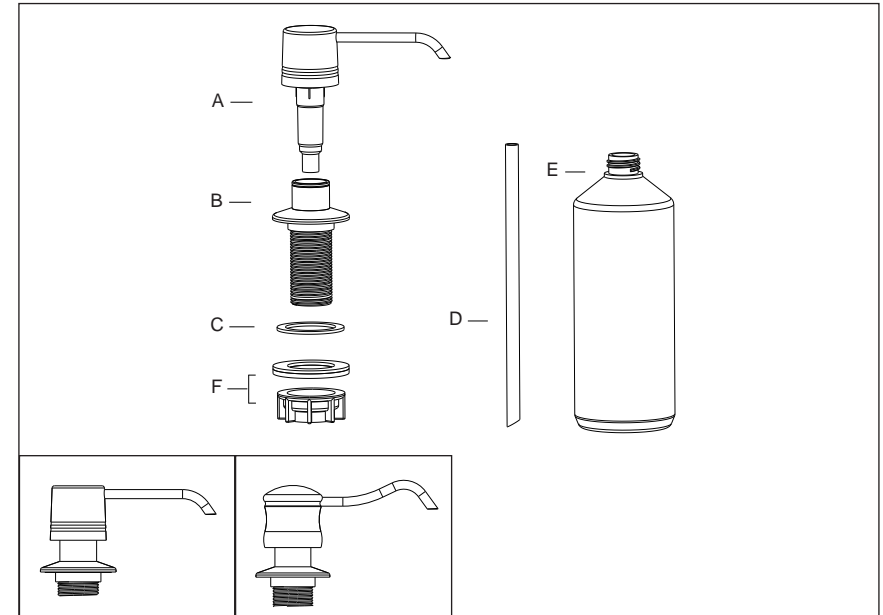

IMPORTANT NOTICES:

For easy installation, please read all the instruction completely before beginning.

Questions, problems, missing parts?
call Akicon Customer Service 8 a.m.-6p.m. EST, Monday-Friday
Phone: +1(302)213 4406, Email: service@akicon.com
AKICONHVAC.COM