

**Network Attached Storage**

**TeraStation 5010**

# **User Manual**

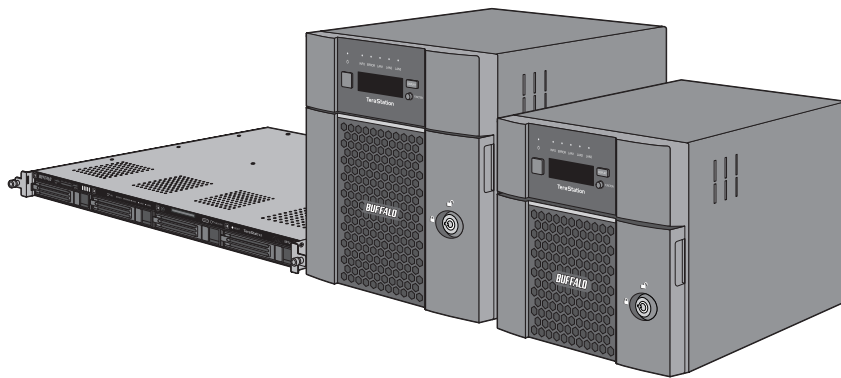

Please make sure to read this manual before using and follow the procedures. If you have any inquiries about the product, contact the number on the warranty statement or the packing box. Do not discard this manual, the warranty statement, or the packing box.

***Americas: [www.buffaloamericas.com](http://www.buffaloamericas.com)***

***Europe: [www.buffalo-technology.com](http://www.buffalo-technology.com)***

***Asia Pacific: [www.buffalo-asia.com](http://www.buffalo-asia.com)***

35021131-06  
2016.12

# Contents

<b>Chapter 1 Getting Started .....</b>	<b>7</b>
Diagrams.....	7
Turning the TeraStation On and Off.....	10
Creating an Initialization Drive.....	12
<b>Chapter 2 Configuration .....</b>	<b>14</b>
Setting Up Through Initial Setup Wizard .....	14
Opening Advanced Settings .....	18
Opening Easy Admin .....	19
<b>Chapter 3 Sharing Files .....</b>	<b>22</b>
<b>Configuring Shared Folders .....</b>	<b>22</b>
Adding a Shared Folder.....	22
Recycle Bin.....	24
Read-Only Shares.....	25
Hidden Shares .....	25
<b>Configuring Users .....</b>	<b>25</b>
Adding a User .....	25
Importing User Information.....	26
<b>Adding a Group .....</b>	<b>27</b>
<b>Configuring Access Restrictions .....</b>	<b>29</b>
Local Users and Groups .....	29
Active Directory .....	30

<b>Chapter 4 Managing Storage.....</b>	<b>34</b>
<b>RAID Modes .....</b>	<b>34</b>
<b>Working with RAID Arrays .....</b>	<b>35</b>
Using JBOD.....	35
Changing RAID Mode .....	36
Configuring a Hot Spare.....	37
RMM (RAID Mode Manager).....	39
RAID Scanning.....	41
<b>Adding an External Drive .....</b>	<b>42</b>
Connecting an External Drive .....	42
Compatibility .....	42
<b>Dismounting Drives .....</b>	<b>43</b>
Dismounting with the Function Button .....	43
Dismounting from Settings .....	43
<b>Checking Drives .....</b>	<b>44</b>
<b>S.M.A.R.T. ....</b>	<b>45</b>
<b>Formatting Drives .....</b>	<b>46</b>
<b>Encrypting Drives.....</b>	<b>48</b>
<b>Erasing Data on the TeraStation Completely .....</b>	<b>48</b>
<b>Drive Quotas.....</b>	<b>49</b>
Quotas for Users.....	49
Quotas for Groups .....	49
Size Limits.....	50
<b>Using the TeraStation as an iSCSI Device .....</b>	<b>53</b>
Introduction .....	53
Creating an iSCSI Volume .....	53
Connecting or Disconnecting Volumes.....	55
Using with Multiple Computers.....	57

Configuring Access Restrictions .....	57
Expanding Volume Sizes .....	61
Deleting Volumes.....	62

## **Chapter 5 Backup ..... 64**

<b>Back Up from the TeraStation .....</b>	<b>64</b>
Preparing a Backup Destination.....	64
Configuring a Backup Job .....	66
Backup Logs .....	69
<b>Replication.....</b>	<b>71</b>
Preparing a Replication Destination .....	72
Configuring a Replication Task .....	72
Synchronizing Between Source and Destination Units Periodically ...	75
<b>Failover .....</b>	<b>76</b>
Usage Restrictions .....	77
Configuring Failover.....	78
Switching to the Backup Unit Manually.....	81
Synchronizing Between Main and Backup Units Periodically.....	81
<b>Backing Up Your Mac with Time Machine .....</b>	<b>82</b>

## **Chapter 6 Remote Access ..... 88**

<b>WebAccess .....</b>	<b>88</b>
<b>FTP.....</b>	<b>90</b>
<b>Cloud Storage.....</b>	<b>92</b>
Configuring Cloud Storage .....	92
Uploading Files to Cloud Storage.....	94
<b>Dropbox Sync .....</b>	<b>97</b>
Configuring a New Task.....	97

Changing Dropbox Task Settings .....	99
Creating a Shared Link (Windows Only).....	102

## **Chapter 7 Advanced Features ..... 103**

<b>Email Notification .....</b>	<b>103</b>
<b>Sleep Mode .....</b>	<b>105</b>
<b>Wake-on-LAN .....</b>	<b>106</b>
<b>UPS (Uninterruptible Power Supply) .....</b>	<b>107</b>
<b>Port Trunking.....</b>	<b>109</b>
<b>Offline Files.....</b>	<b>110</b>
<b>Accessing from an NFS Client.....</b>	<b>111</b>
<b>Encrypting Data Transmission .....</b>	<b>114</b>
<b>Encrypting Settings Data .....</b>	<b>114</b>
<b>Encrypting FTP Transfer Data .....</b>	<b>115</b>
<b>SSL Keys .....</b>	<b>115</b>
<b>SNMP .....</b>	<b>115</b>
<b>Saving and Applying Settings.....</b>	<b>116</b>
<b>Saving Settings .....</b>	<b>117</b>
<b>Applying Settings .....</b>	<b>118</b>
<b>Transferring Another TeraStation's Settings .....</b>	<b>119</b>
<b>Creating a Config File (.nas_config).....</b>	<b>119</b>
<b>Transferring Settings.....</b>	<b>120</b>
<b>Restoring Factory Defaults.....</b>	<b>121</b>
<b>Initializing from Settings .....</b>	<b>121</b>
<b>Initializing with the USB Initialization Drive .....</b>	<b>121</b>
<b>Resetting the Administrator Password .....</b>	<b>122</b>
<b>Logs .....</b>	<b>123</b>

<b>Displaying TeraStation's Logs .....</b>	<b>123</b>
<b>Transferring Logs to the Syslog Server .....</b>	<b>123</b>
<b>Creating a Link to the Logs in the Shared Folder .....</b>	<b>124</b>
<b>Updating the Firmware.....</b>	<b>125</b>
<b>Updating Manually .....</b>	<b>125</b>
<b>Updating Automatically .....</b>	<b>126</b>
<b>Sending Usage Feedback .....</b>	<b>127</b>
<b>Name, Date, Time, and Language .....</b>	<b>128</b>
<b>Beep Alerts .....</b>	<b>131</b>
<b>LCD and LEDs .....</b>	<b>132</b>
<b>Proxy Server .....</b>	<b>133</b>
<b>Jumbo Frames .....</b>	<b>134</b>
<b>Changing the IP Address .....</b>	<b>137</b>
<b>Boot Authentication .....</b>	<b>139</b>
<b>Note Before Use .....</b>	<b>139</b>
<b>Important Notice .....</b>	<b>139</b>
<b>Setting Up the Authentication Server on a Windows PC .....</b>	<b>140</b>
<b>Configuring Boot Authentication on the TeraStation.....</b>	<b>140</b>
<b>If the TeraStation Cannot Be Accessed .....</b>	<b>142</b>

## **Chapter 8 Replacing Drives ..... 145**

<b>LEDs.....</b>	<b>145</b>
<b>Drive Replacement Procedure .....</b>	<b>146</b>
<b>Using JBOD or a Redundant RAID Mode and TeraStation Is On.....</b>	<b>146</b>
<b>Using a Redundant RAID Mode and TeraStation Is Off .....</b>	<b>148</b>
<b>Using RAID 0.....</b>	<b>149</b>
<b>Using a Hot Spare.....</b>	<b>149</b>

**Replacing a Non-Malfunctioning Drive..... 150**

**Chapter 9 Utilities..... 151**

**NAS Navigator2 for Windows..... 151**  
    **Mounting as a Network Drive ..... 154**  
    **Changing the IP Address ..... 155**  
**NAS Navigator2 for Mac ..... 156**  
    **Mounting as a Network Drive ..... 158**  
    **Changing the IP Address ..... 159**  
**NovaBACKUP ..... 160**

**Chapter 10 Appendix ..... 161**

**TeraStation Does Not Boot Properly ..... 161**  
    **Booting the TeraStation in Emergency Mode..... 161**  
    **Power LED Keeps Blinking ..... 161**  
**Cleaning the Dustproof Filter ..... 162**  
**LCD Panel ..... 164**  
    **Modes ..... 164**  
    **Errors..... 165**  
    **Status ..... 166**  
**Default Settings ..... 168**  
**Specifications ..... 169**

**Chapter 11 Regulatory Compliance Information... 170**

**For Customers in the United States ..... 170**  
**For Customers in Europe ..... 170**  
**For Customers in Taiwan..... 173**

# Chapter 1 Getting Started

## Diagrams

Depending on the number or type of drives in the unit, the model name will be different. Check the sticker on the packing box for your unit's model name.

### TS5410DN

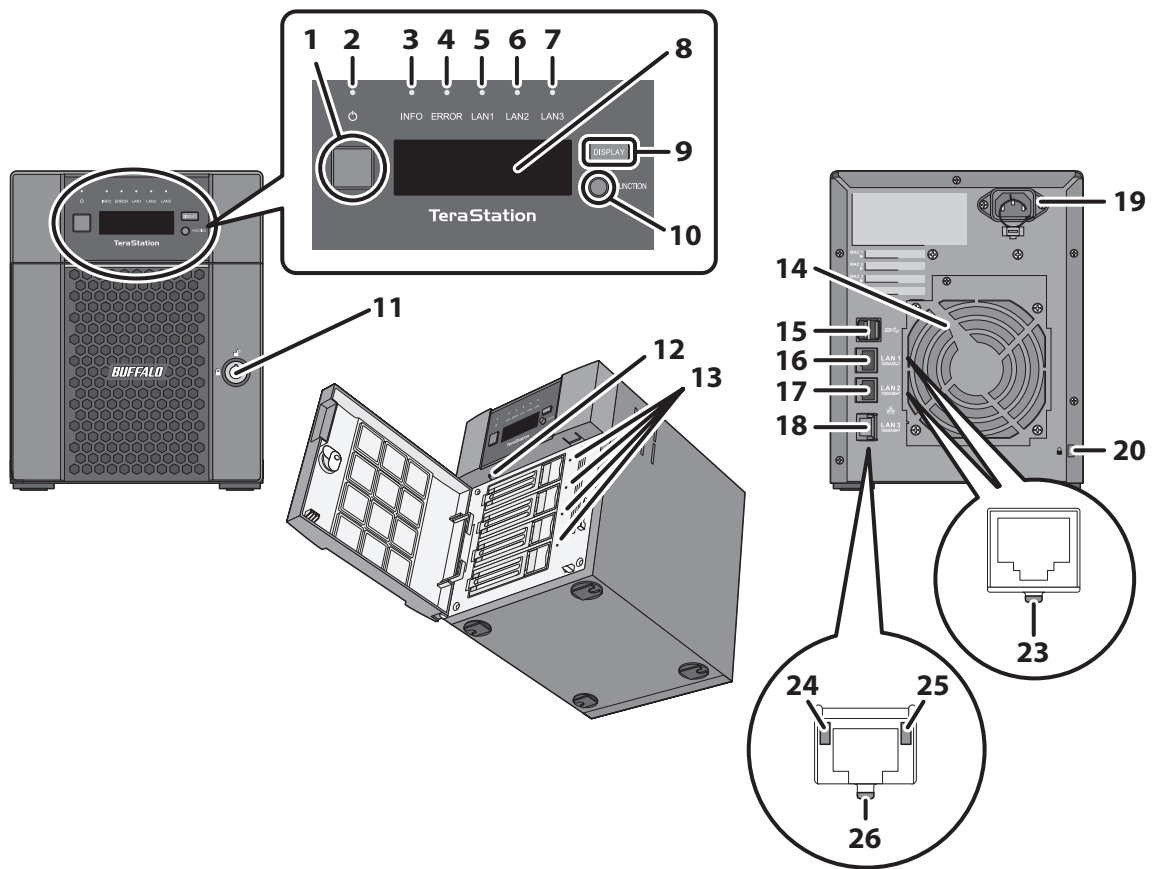

## TS5410RN

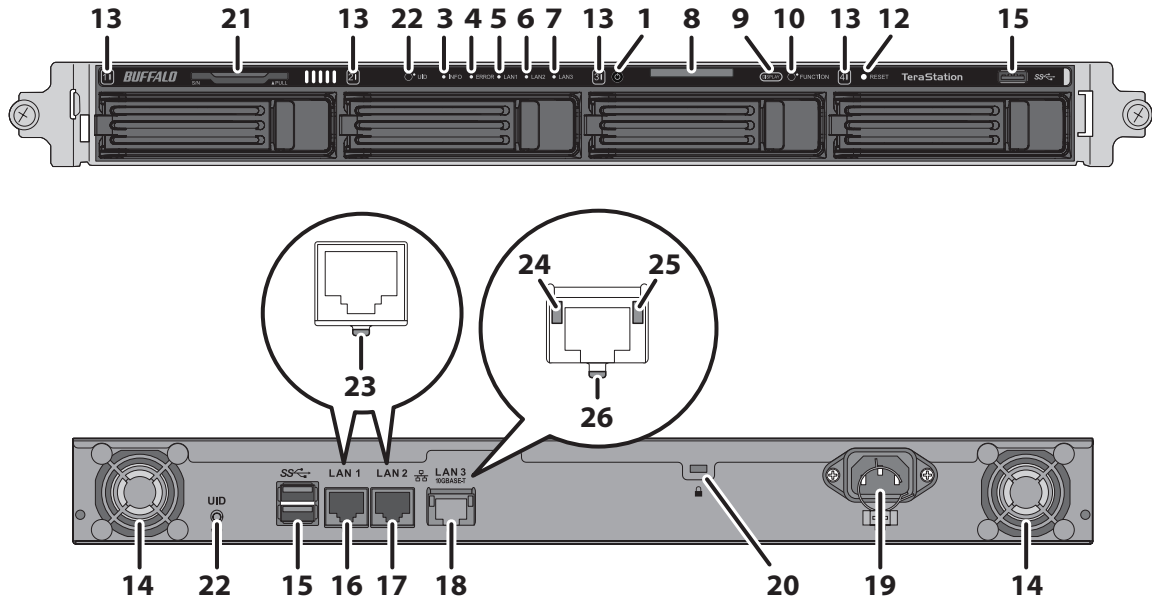

## TS5210DN

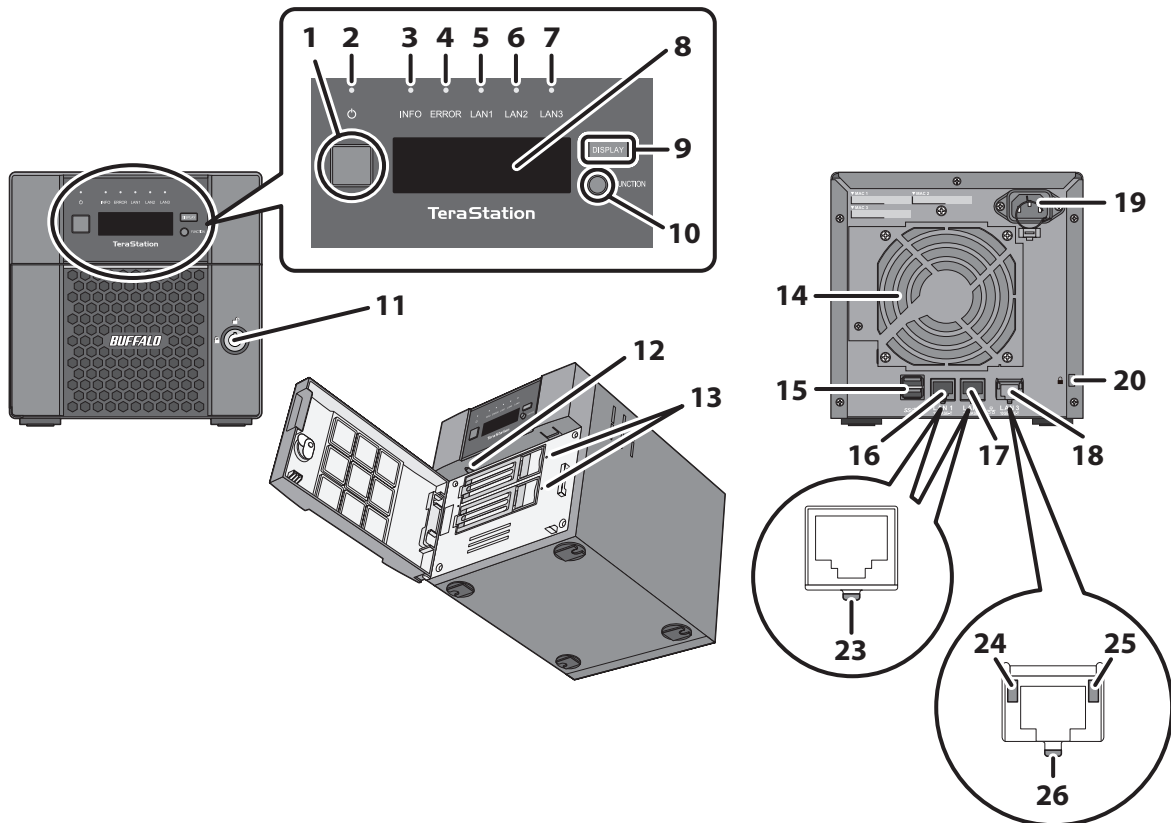

### 1 Power Button (⏻)

To power on, connect the power cable and wait for 10 seconds, then press the power button. To power off, press and hold the power button for 3 seconds.

### 2 Power LED

When the TeraStation is on, the LED glows green.

### 3 Info LED

If there is a status message, the amber info LED will light up. Check the LCD panel to see the status message.

### 4 Error LED

If there is an error, the red error LED will light up. Check the LCD panel to see the error message.

### 5 LAN1 LED

When LAN port 1 is connected, this LED glows green. It blinks when the connection is active.

### 6 LAN2 LED

When LAN port 2 is connected, this LED glows green. It blinks when the connection is active.

### 7 LAN3 LED

When LAN port 3 is connected, this LED glows blue. It blinks when the connection is active.

### 8 LCD Panel

This display shows the status of many TeraStation settings. It also displays errors and messages when available.

### 9 Display Button

Switches between the different display modes. Also, if the TeraStation is beeping, press this button to stop it.

### 10 Function Button

Use this button for dismounting USB devices, rebuilding RAID arrays, configuring failover, stopping the TeraStation's beeping, and initializing settings using a USB drive.

### 11 Drive Lock ( )

Open the front panel with the key to replace drives or access the init button.

### 12 Init Button

Hold down this button with something pointed to initialize the TeraStation's admin username and password, IP settings, SSL, and service port restriction settings to their factory default values. The effects of this button can be modified in Settings.

### 13 Status LEDs

Normally, these LEDs blink green when drives are accessed. If a drive fails, its LED will turn red.

### 14 Fan

Spins to avoid overheating inside. Do not block the fan.

### 15 USB 3.0 Port ( )

Compatible Buffalo USB drives, USB flash drives, digital cameras, and USB UPS connections can be connected. USB hubs are not supported.

### 16 LAN Port 1 ( )

Use an Ethernet cable to connect this port to your network for connecting at 1000 Mbps.

### 17 LAN Port 2 ( )

This second Ethernet port may be used for network redundancy or backup for connecting at 1000 Mbps. You may connect a second TeraStation directly to this port for backup.

### 18 LAN Port 3 ( )

Use an Ethernet cable to connect this port to your network for connecting at 10 Gbps.

**Note:** To communicate at up to 10 Gbps, all network devices must be compatible with 10GbE.

## 19 Power Connector

Use the included power cable to connect to an UPS, surge protector, or outlet.

## 20 Anti-Theft Security Slot (🔒)

Use this slot to secure your TeraStation with a cable lock (not included).

## 21 Serial Number

This sticker shows the TeraStation's serial number.

## 22 UID Button

Press the UID button on the front or the back of the unit to cycle the blue LED on and off.

## 23 Link LED

Glow green when the unit is connected to a network.

## 24 100 Mbps or 2.5/5 Gbps Link LED

Glow amber when the unit is connected to a network at 100 Mbps or 2.5/5 Gbps.

## 25 1000 Mbps Link LED

Glow green when the unit is connected to a network at 1000 Mbps.

## 26 10 Gbps Link LED

Glow blue when the unit is connected to a network at 10 Gbps.

---

# Turning the TeraStation On and Off

---

**Note:** Do not disconnect or reconnect the internal drives while turning on or off the TeraStation.

Press the power button on the TeraStation to turn it on.

To turn off the TeraStation, press and hold the power button for 3 seconds. Don't unplug the TeraStation without turning it off first. You can also shut it down and restart it remotely from Settings.

- 1 Double-click the  icon to start NAS Navigator2.

- 2 Right-click your TeraStation's icon and select *Settings*. For macOS, select the TeraStation's icon while holding down the control key, then select *Settings*.

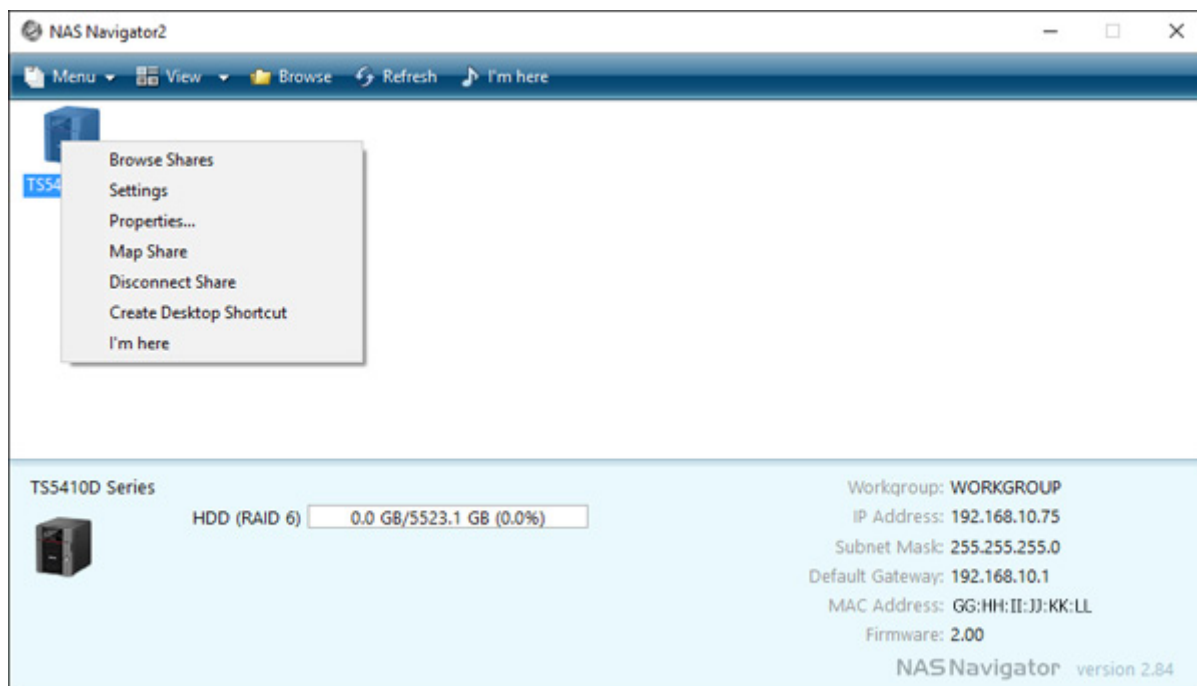

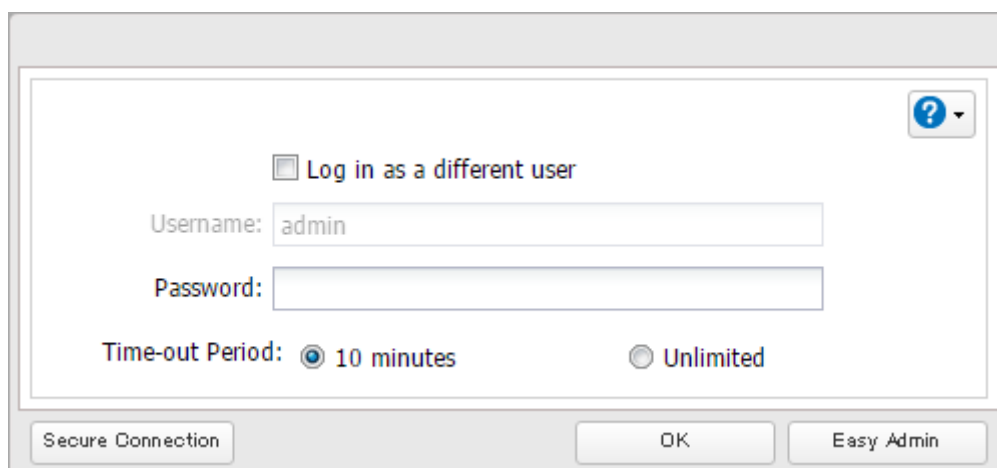

- 3 Enter the username and password, then click *OK*.

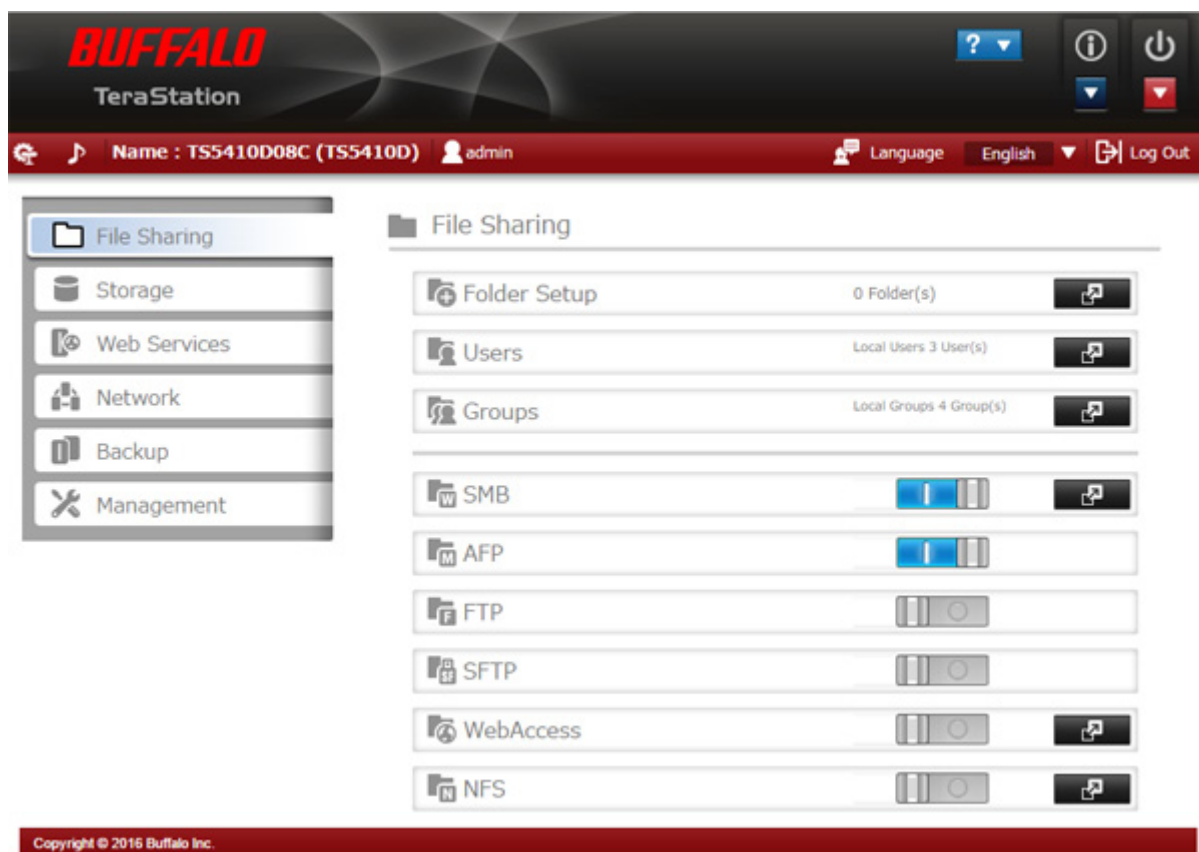

**Note:** The default username and password are "admin" and "password".

4 Settings will open.



5 Click  at the top-right of Settings and choose *Shut Down*.

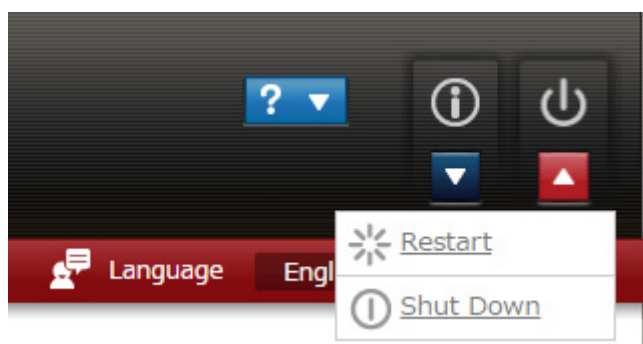

6 Click Yes.

7 The "Confirm Operation" screen will open. Enter the confirmation number, then click *OK*.

When all the LEDs on the front of the TeraStation turn off, the shutdown process is complete.

---

## Creating an Initialization Drive

---

We recommend creating an initialization drive as soon as possible. This USB drive can be used to initialize the TeraStation's settings to its factory default values, or recover the system if your TeraStation encounters an error that

prevents the unit from booting. For detailed procedure, refer to the "Creating an Initialization Drive" subsection in chapter 7.

# Chapter 2 Configuration

Configure and manage your TeraStation using the Settings interface, accessible from a browser window. Open the interface using the procedure below or type the TeraStation's IP address in the URL field of your browser. Within Settings, the Easy Admin page gives you quick access to commonly used settings.

**Note:** Microsoft Edge, Firefox, Google Chrome, Internet Explorer 9 or later, and Safari 9 or later are supported. If you have difficulty viewing Settings, check the following:

- If there are a large number of registered users, groups, or shared folders, use another browser instead of Internet Explorer.
- If you have a proxy server enabled in the browser settings, disable the proxy server.
- With Internet Explorer, set security to *Local intranet*. On Windows Server operating systems, higher-level security is configured by default. Set the security to a lower level temporarily.
- On a Mac, you can also use Bonjour to log in to Settings. Navigate to *Bookmarks - Bonjour - TeraStation name* from the menu bar of Safari. If you don't see "Bonjour" in the Bookmarks menu, click *Safari - Preferences* and select "Include Bonjour in the Bookmarks menu" under "Advanced".

---

## Setting Up Through Initial Setup Wizard

---

When you access Settings for the first time, or after initializing the TeraStation's settings, the initial setup wizard will be displayed. To set up the TeraStation using the wizard, follow the procedure below.

1 Double-click the  icon to start NAS Navigator2.

2 Right-click on your TeraStation's icon in NAS Navigator2 and select *Settings*. For macOS, click your TeraStation's icon while holding down the control key, then select *Settings*.

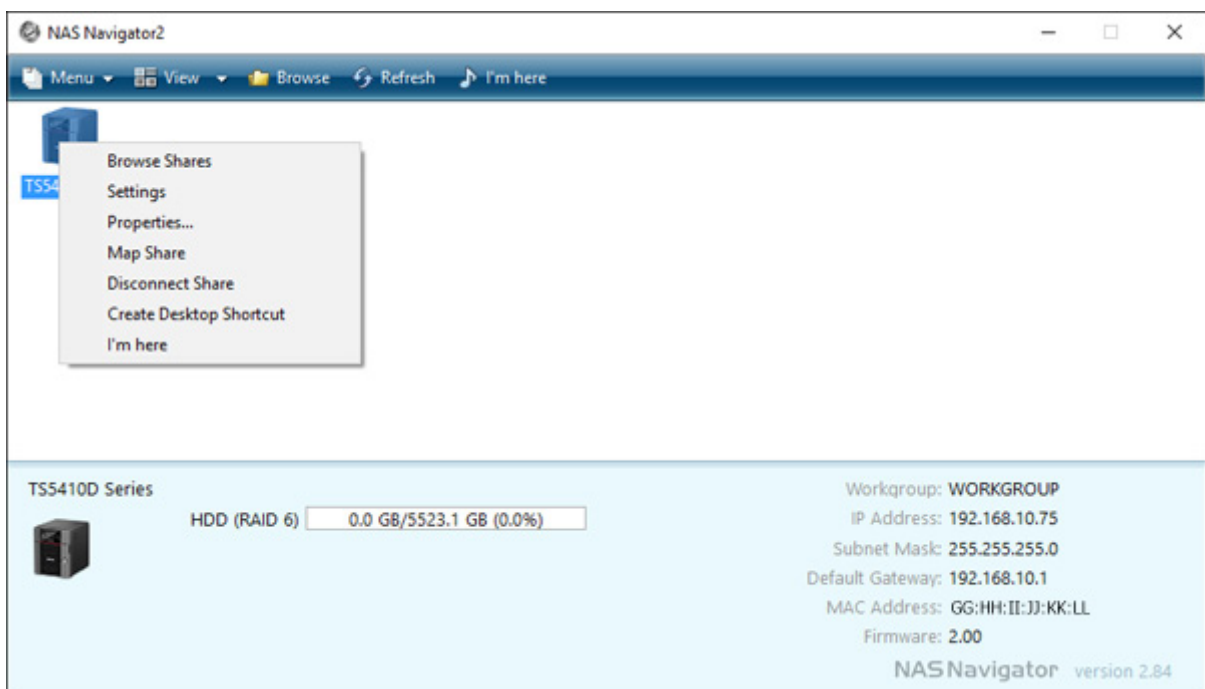

- 3** The password settings page will be displayed. Enter the desired new administrator password and click *Next*. If you click *Skip*, the administrator password will not change from the default value ("password").

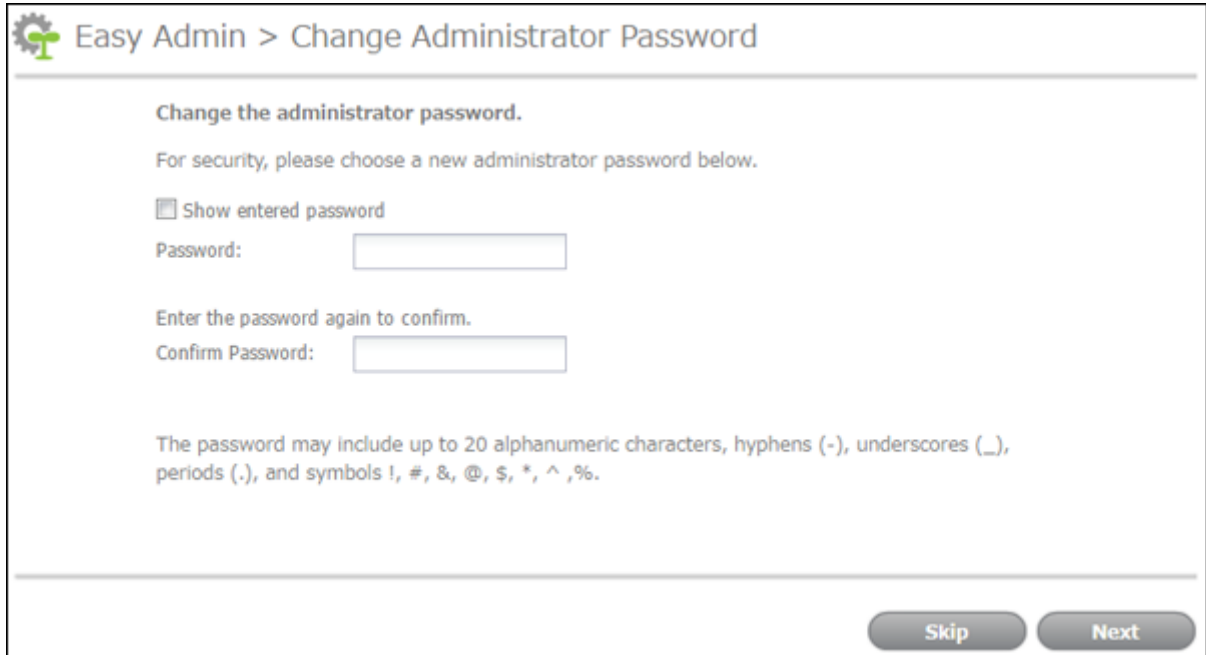

Easy Admin > Change Administrator Password

Change the administrator password.

For security, please choose a new administrator password below.

Show entered password

Password:

Enter the password again to confirm.

Confirm Password:

The password may include up to 20 alphanumeric characters, hyphens (-), underscores (\_), periods (.), and symbols !, #, &, @, \$, \*, ^, %.

Skip Next

- 4** The time zone settings page will be displayed. If you need to change the time zone from that which is currently displayed on the page, select it from the drop-down list and click *Next*.

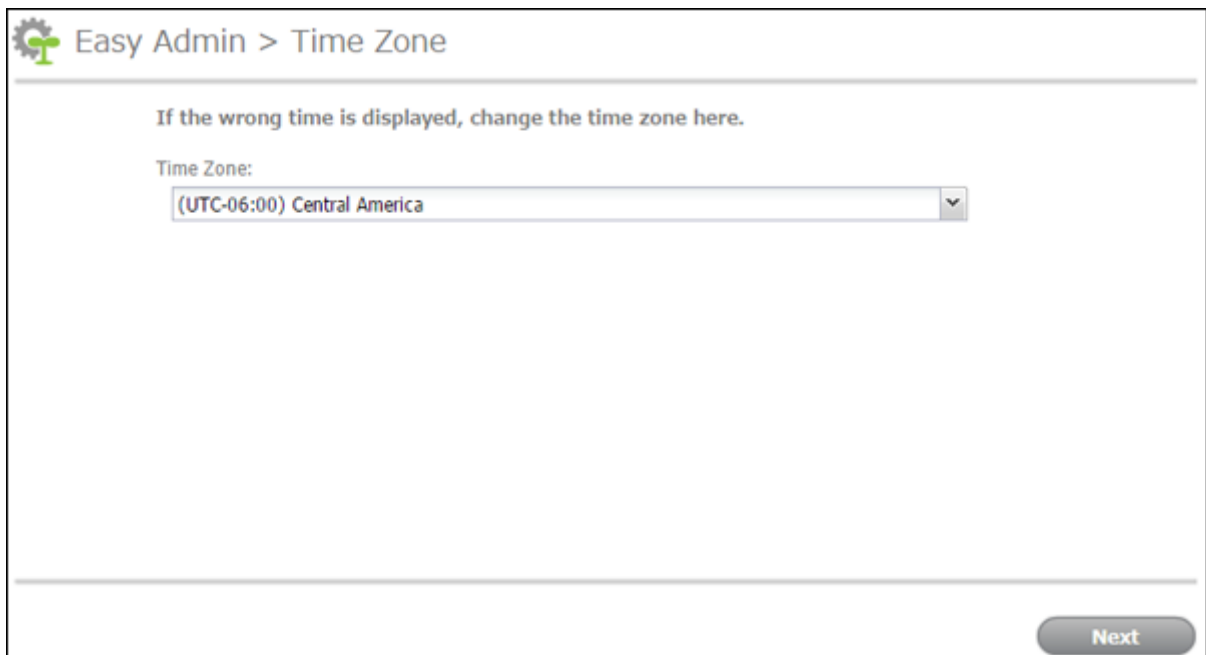

Easy Admin > Time Zone

If the wrong time is displayed, change the time zone here.

Time Zone:

(UTC-06:00) Central America

Next

- 5 The proxy server settings page will be displayed. If you place the TeraStation under a proxy network, set your proxy settings. Click *Next*.

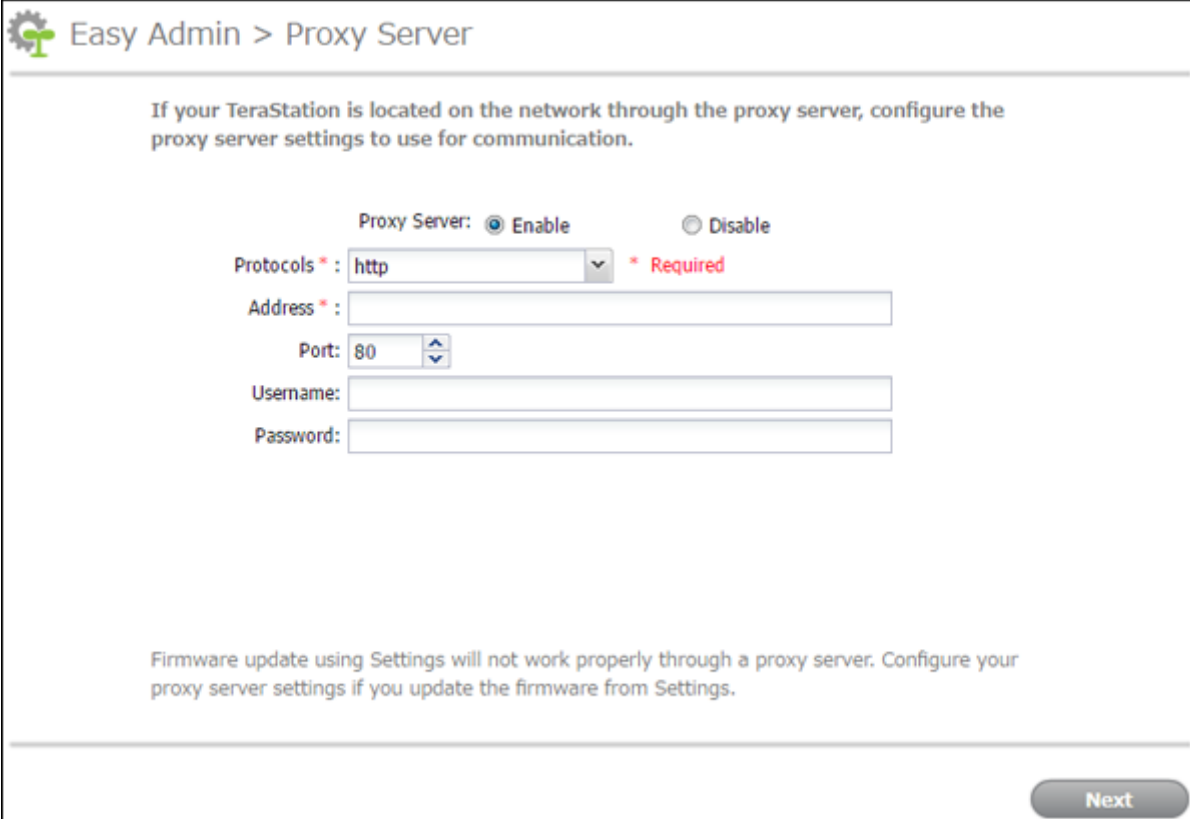

The screenshot shows the 'Easy Admin > Proxy Server' configuration page. At the top, there is a gear icon and the text 'Easy Admin > Proxy Server'. Below this, a message states: 'If your TeraStation is located on the network through the proxy server, configure the proxy server settings to use for communication.' The main configuration area includes a 'Proxy Server' section with two radio buttons: 'Enable' (selected) and 'Disable'. Below this are several input fields: 'Protocols \*' with a dropdown menu showing 'http' and a red asterisk indicating it is required; 'Address \*' with an empty text box; 'Port' with a dropdown menu showing '80'; 'Username' with an empty text box; and 'Password' with an empty text box. At the bottom of the page, there is a note: 'Firmware update using Settings will not work properly through a proxy server. Configure your proxy server settings if you update the firmware from Settings.' and a 'Next' button.

- 6 The RAID settings page will be displayed. To change the RAID mode from the default mode, select the desired RAID mode and click *Next*, then click *Start* in the next page. The "Confirm Operation" screen will open so enter the confirmation number and click *OK*. Changing the RAID mode will begin.

If you want to keep the RAID mode as is, select "Keep current RAID mode" and click *Next*.

**Easy Admin > RAID Mode**

Select your desired RAID mode.

**If you change the RAID mode, all data on the drives will be lost.**

**To avoid removing any important data unexpectedly, it is recommended to use a RAID mode that offers redundancy and back up regularly.**

**Keep current RAID mode**  
Current RAID Mode: RAID 5 (Drive 1, 2, 3, 4 / Capacity: 10.9 TB)  
The wizard will finish without changing the RAID mode.

**RAID 5**  
Identical data will be written to multiple drives with parity, resulting in both faster performance and redundancy in case a single drive fails.  
Capacity: 10.9 TB  
Redundancy:   
Performance:

**RAID 6**  
Identical data will be written to multiple drives with parity, resulting in redundancy in case up to two drives fail.  
Capacity: 7.3 TB  
Redundancy:   
Performance:

**Next**

**Note:** The RAID settings page will not be displayed if using TS5210DN series.

- 7** The usage feedback settings page will be displayed. If you allow Buffalo to collect your usage and environment information, select the "Send usage feedback" box. If you don't permit information collection, leave the box blank and click *Next*.

**Easy Admin > Send Usage Feedback to Buffalo**

**This firmware will send your usage information to Buffalo automatically.**

The usage information may include your TeraStation series name, firmware version, some settings such as number of shared folders, some drive information such as S.M.A.R.T., usage environment such as number of client PCs. None of the collected information contains your personal data such as usernames and passwords.

Buffalo will only use the collected information to improve future firmware quality and no other purpose.

This setting can be changed from Advanced Settings. Refer to the user manual for more detailed information.

**Send usage feedback**

**Next**

**8** The folder path to access shared folders will be displayed and the initial setup will finish.

---

## Opening Advanced Settings

---

- 1 Double-click the  icon to start NAS Navigator2.
- 2 Right-click on your TeraStation's icon in NAS Navigator2 and select *Settings*. For macOS, click your TeraStation's icon while holding down the control key, then select *Settings*.

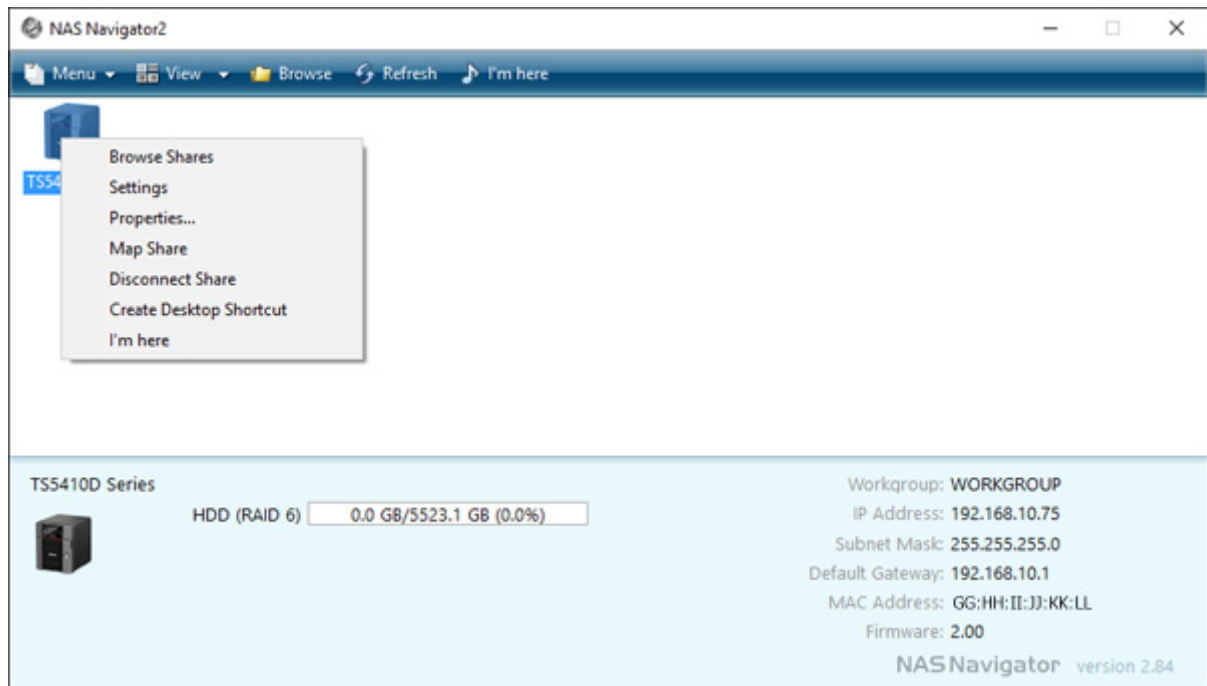

- 3 Enter the username and password and click *OK*.

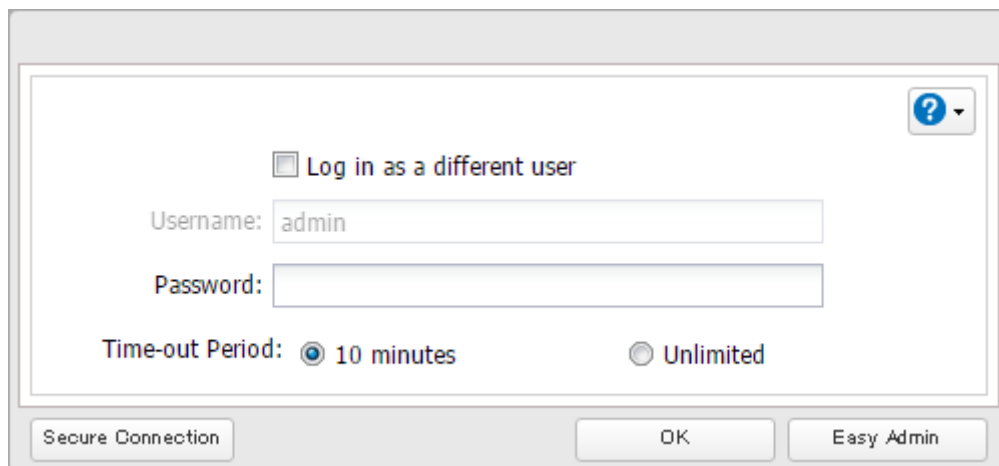

### Notes:

- If the time-out period is set to "10 minutes", you will be logged out of Settings after 10 minutes of inactivity.
- Click *Secure Connection* to log in with an encrypted connection.

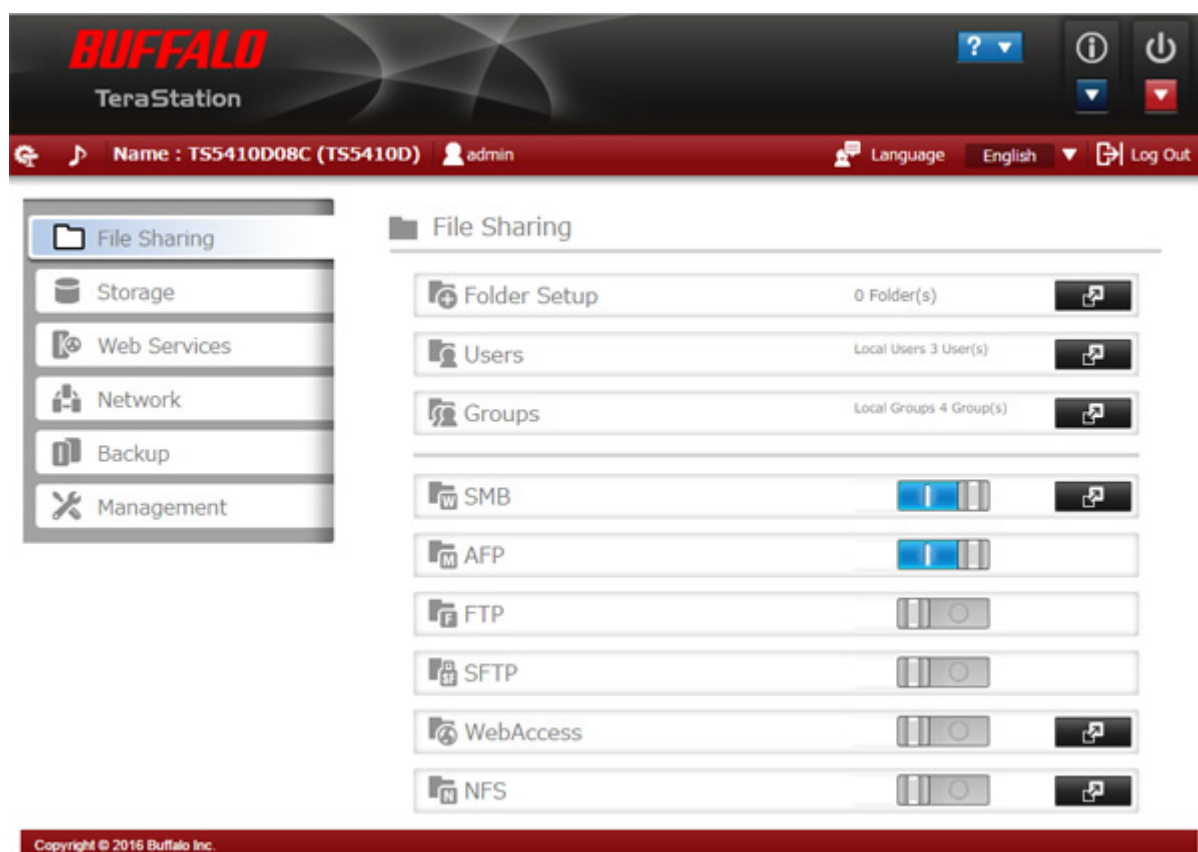

4 Settings will open.



**Notes:**

- Username/Password Combinations:

Username	Password	Settings Available
admin	password	All
guest	blank	System information (read-only)
Your username	Your password	If a user is assigned as an administrator, all settings are available. If assigned under another group, only system information (read-only) is available.

- Click  to open Easy Admin.
- Click  to play a tone from the TeraStation for easy location.

## Opening Easy Admin

The Easy Admin page makes it easy to change common settings. Follow the procedure below to open Easy Admin.

- 1 Double-click the  icon to start NAS Navigator2.

**2** Right-click on your TeraStation's icon and choose *Settings*. For macOS, click the TeraStation icon while holding down the control key, then select *Settings*.

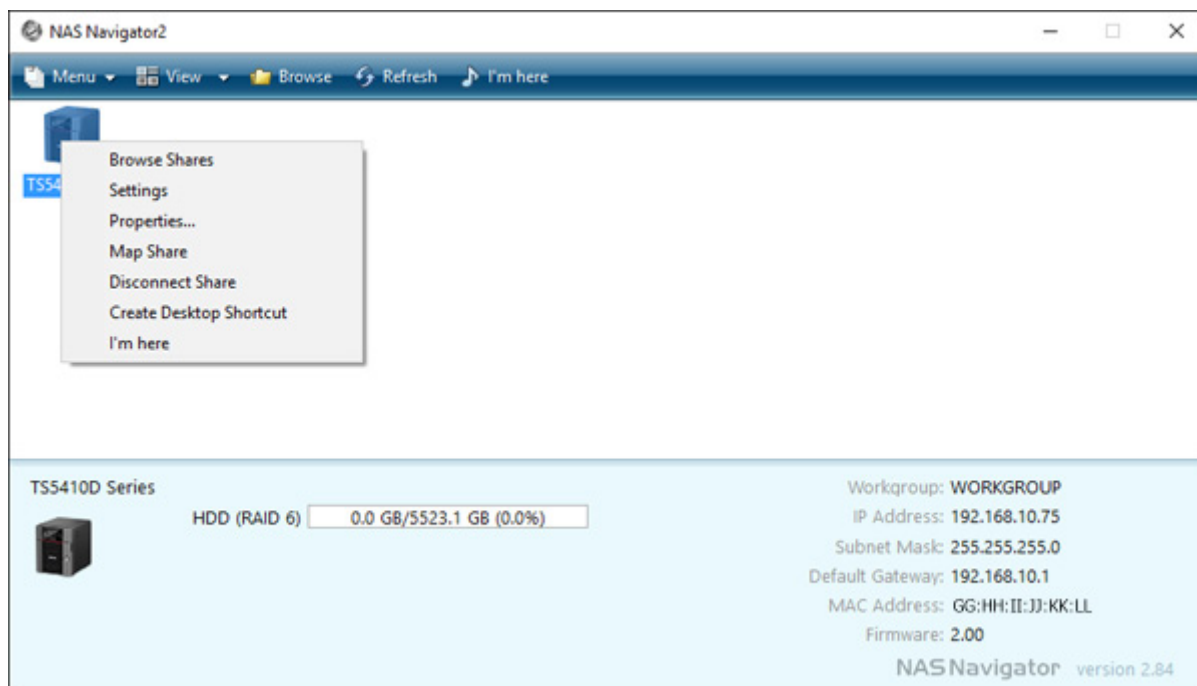

**3** Click *Easy Admin*.

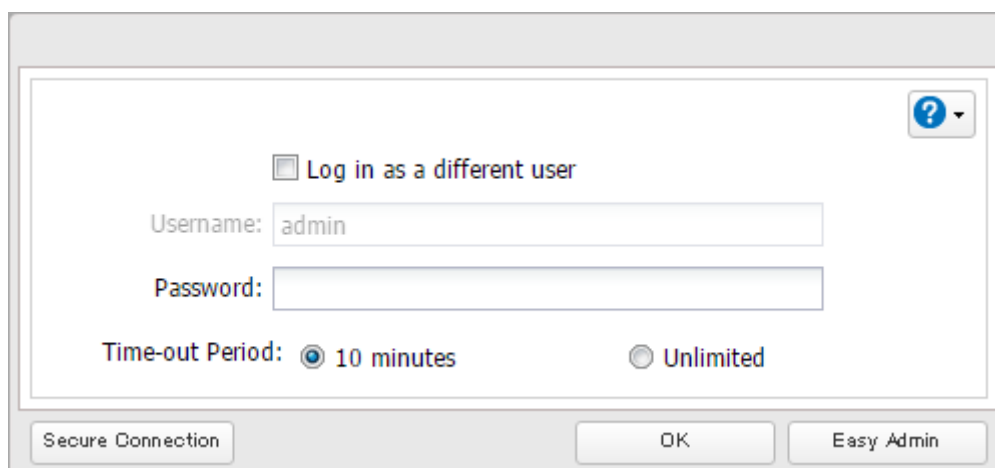

4 The Easy Admin screen will open.

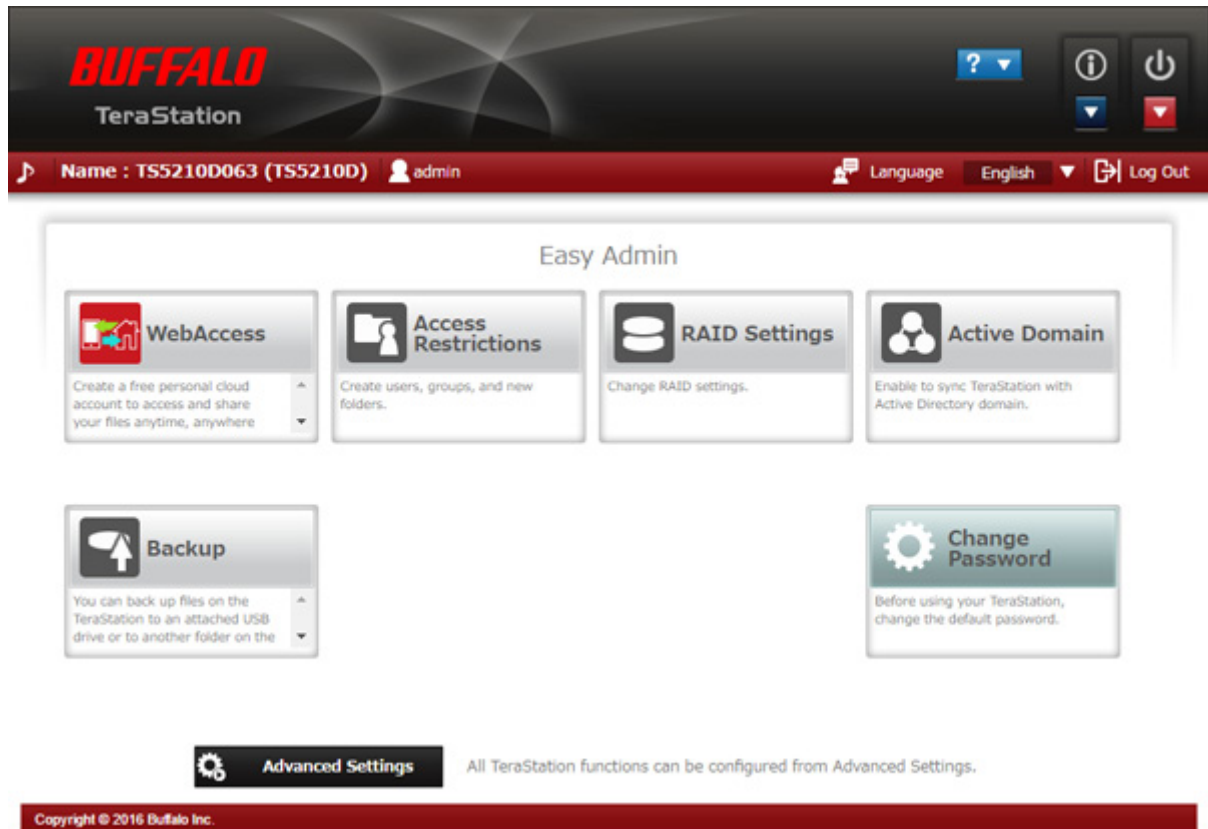

**Note:** If you click any buttons, you will need to enter a username and password.

# Chapter 3 Sharing Files

---

## Configuring Shared Folders

---

### Adding a Shared Folder

---

**1** In Settings, click *File Sharing*.

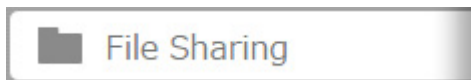

**2** Click  to the right of "Folder Setup".

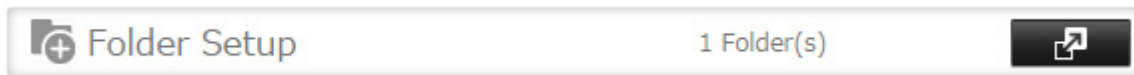

**3** Click *Create Folder*.

**4** Configure the desired settings, then click *OK*.

**Shared Folder Settings**

\*Required ?

Copy Settings from: [ ]

Name \* : [ ]

Description: [ ]

Drive/Array: Drive 1

Attribute:  Read only  Read & write

Recycle Bin:  Enable  Disable

LAN Protocol Support:  SMB (Windows/Mac)  AFP (Mac)

FTP  Backup

SFTP  WebAccess

NFS

— NFS Path —

Folder Attributes:  Hidden share (SMB only)

Backup Access Password: [ ]

WebAccess Permissions: Allow anonymous

Offline Files: Offline files disabled

Access Restrictions:  Enable  Disable

Local Users Local Groups Domain Users Domain Groups

Filter: [ ]

Local Username	W	R	
admin	<input checked="" type="radio"/>	<input checked="" type="radio"/>	<input checked="" type="radio"/>
guest	<input type="radio"/>	<input type="radio"/>	<input checked="" type="radio"/>

OK Cancel

**Notes:**

- Names may contain up to 27 alphanumeric characters, hyphens (-), and underscores (\_). Do not use a symbol as the first character in a name.
- The description may contain up to 75 alphanumeric characters, hyphens (-), underscores (\_), and spaces. Do not use a symbol or space as the first character.
- You may create up to 400 shared folders.
- If the names of shared folders accessed via AFP and FTP connections contain multibyte characters, configure the client language in *Management - Name/Time/Language* to match the characters. If the setting does not match, the shared folder name will not be displayed correctly.



- If you use macOS, select "Keep when original file is deleted" for "Mac OS Temp Files" option. If this setting is changed, files in the recycle bin may be corrupted.

## Read-Only Shares

---

By default, new shares are set with read and write access, but you may change the attribute to *Read only* in *Attribute*. Read-only shares and HFS Plus-formatted USB drives will have "(Read Only)" added to comments in Explorer.

**Note:** Configure read-only file attribute in Settings. Configuring them from within Windows is not supported and may cause unexpected behavior.

## Hidden Shares

---

If hidden shares are enabled, shared SMB folders will not be displayed in Network, and only certain users are allowed to access them. To hide a shared SMB folder, follow the procedure below.

- 1** In Settings, navigate to *File Sharing - Folder Setup* and choose a shared folder or a USB drive to configure hidden shares.
- 2** Select the "Hidden share (SMB only)" checkbox and click *OK*.

### Notes:

- If protocols other than "SMB" or "Backup" under "LAN Protocol Support" are enabled, the hidden shares option will be grayed out and cannot be selected.
- Configure hidden share attribute in Settings. Configuring them from within Windows is not supported and may cause unexpected behavior.

To access a hidden folder, open File Explorer in your computer and enter "\\TeraStation name\Shared folder name\$" for the name. For example, if the TeraStation name is "TSXXX001" and the shared folder name is "share", enter "\\TSXXX001\share\$" to open it.

---

## Configuring Users

---

### Adding a User

---

**Note:** The TeraStation can register a maximum 300 of users, which includes the default users "admin" and "guest".

- 1** In Settings, click *File Sharing*.

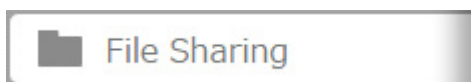

- 2** Click  to the right of "Users".



- 3** Click *Create User*.

#### 4 Enter the desired settings, then click OK.

**User Settings**

\* Required ?

Username: \*

User ID:  
Enter a number from 1000 to 1999.

Email:

Password: \*

Confirm Password: \*

Description:

Quota:

Enable (Units: GB)

Quota Alert Capacity: 1

Quota Capacity: 1

Disable

Filter:

Group
<input checked="" type="checkbox"/> hdusers
<input type="checkbox"/> admin

Select All Deselect All

Primary Group:  
hdusers

OK Cancel

#### Notes:

- Usernames may contain up to 128 characters, including hyphens (-), underscores (\_), periods (.), !, #, &, @, \$, \*, ^, and %. Do not use a symbol as the first character.
- The user ID should be a number from 1000 to 1999. Each user ID should be unique. If this field is left blank, a user ID is assigned automatically.
- Do not duplicate user IDs, group IDs, usernames, or group names. Each should be distinct and unique.
- The description may contain up to 75 alphanumeric characters, hyphens (-), underscores (\_), and spaces. Do not use a symbol or space as the first character.
- Passwords may contain up to 20 alphanumeric characters and the following characters: - \_ @ ! # \$ % & ' ( ) \* + , . / ; < > = ? " [ ] ^ { } | ~. Do not use a symbol other than an underscore (\_) as the first character.
- Use the same username and password for both Windows and the TeraStation or you may not be able to access shared folders.
- Do not use any of the following words for a username as these words are reserved for internal use by the TeraStation: \_lldpd, admin, apache, avahi, avahi-autoipd, backup, bin, daemon, ftp, games, gnats, guest, halt, irc, libuuid, list, lp, mail, man, messagebus, mysql, news, nobody, ntp, openldap, proftpd, proxy, puppet, root, rpc, rpcuser, snmp, sshd, statd, sync, sys, syslog, uucp, www-data

## Importing User Information

You can import users in *File Sharing - Users* by clicking *Import CSV File*.

Format for user data: Username (required), password (required), and user description (optional).

Example 1: Importing usernames, passwords, and comments

username1,password1,comment1  
username2,password2,comment2  
username3,password3,comment3

Example 2: Importing usernames and passwords

username1,password1,  
username2,password2,  
username3,password3,

### Guidelines:

- Use commas (,) as separators. Do not put spaces before or after commas. If you don't want user descriptions, use a comma after password at the end.
- If a line has an incorrect format, the user on that line will not be registered.
- If a username already exists, the new user information will overwrite the old information.
- Do not use commas (,) in the username, password, or user description.

**Note:** Imported users are added to the "hdusers" group automatically.

---

## Adding a Group

---

**1** In Settings, click *File Sharing*.

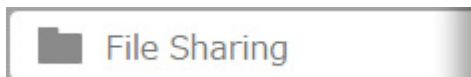

**2** Click  to the right of "Groups".



**3** Click *Add Group*.

**4** Enter the desired settings, then click *OK*.

**Notes:**

- Group names may contain up to 20 alphanumeric characters, hyphens (-), underscores (\_), and periods (.). Do not use a symbol other than an underscore (\_) as the first character.
- Group descriptions may contain up to 75 alphanumeric characters, hyphens (-), underscores (\_), and spaces. Do not use a symbol or space as the first character.
- If the group ID field is left blank, a group ID is automatically assigned. Use numbers between 1000 and 1999 to set a group ID manually. Don't use duplicate group IDs.
- You may register up to 300 groups with the TeraStation.
- If you are logged in as a member of the general users group, you can only change your own password. If you're logged in as an administrator, you can change any settings, including other users' passwords. If you are logged in as a member of the power users group, you can create and edit shared folders, users, and groups.
- Do not use any of the following words for a group name as these words are reserved for internal use by the TeraStation: adm, admin, administrator, all, apache, bin, daemon, disk, ftp, ftpuser, guest, halt, hdusers, kmem, lp, mail, man, mysql, news, nobody, nogroup, none, operator, root, shadow, shutdown, sshd, sync, sys, tty, users, utmp, uucp, www

# Configuring Access Restrictions

You may restrict access to specific shared folders, including external USB drives.

## Notes:

- Access restrictions can be set separately for each shared folder, but not for folders within the shared folders.
- Configure access restrictions through Settings. Configuring access restrictions through Windows is not supported and may cause unexpected behavior.
- You can also configure users, groups, and shared folders from Easy Admin by clicking *Access Restrictions*.
- Shared folders with limited access can still be used as backup destinations.
- If you change access restrictions for a user or group while they are accessing files, unexpected behavior may result.

## Local Users and Groups

**1** In Settings, click *File Sharing*.

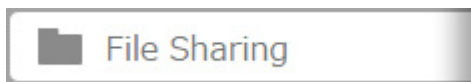

**2** Click  to the right of "Folder Setup".



**3** Click the shared folder that you want to set access restrictions for.

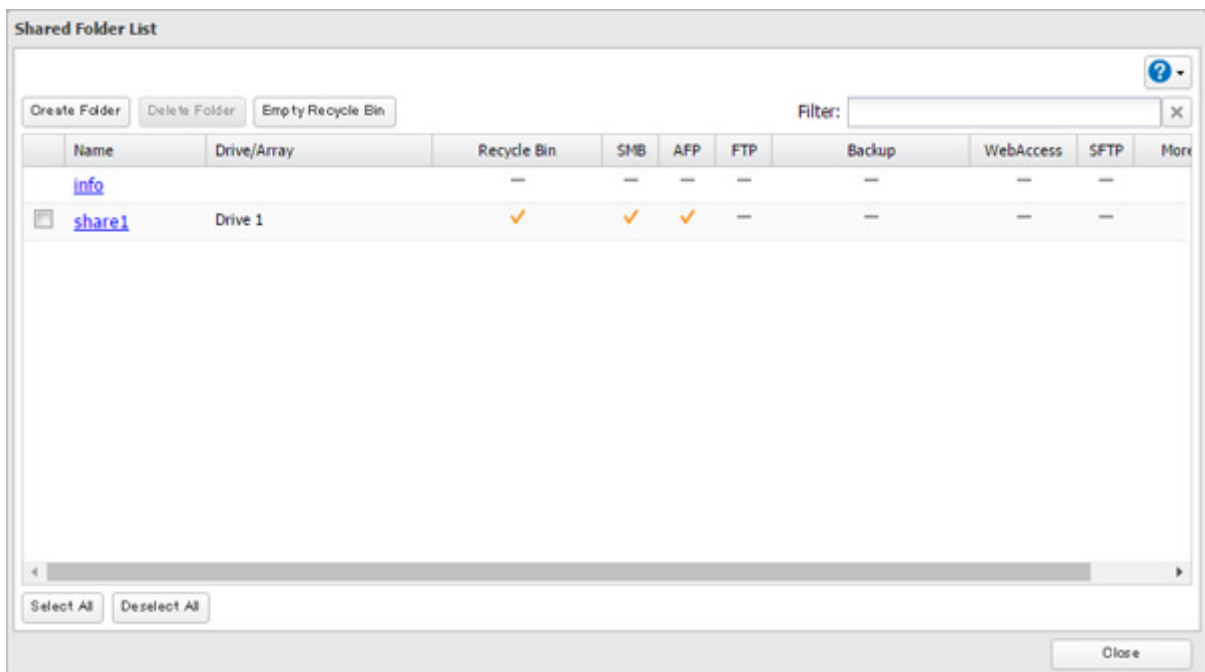

**4** Click *Edit*.

**5** Enable "Access Restrictions".

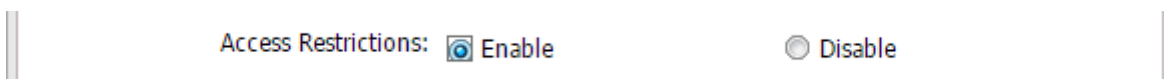

**6** Select the level of access for the user or group you added.

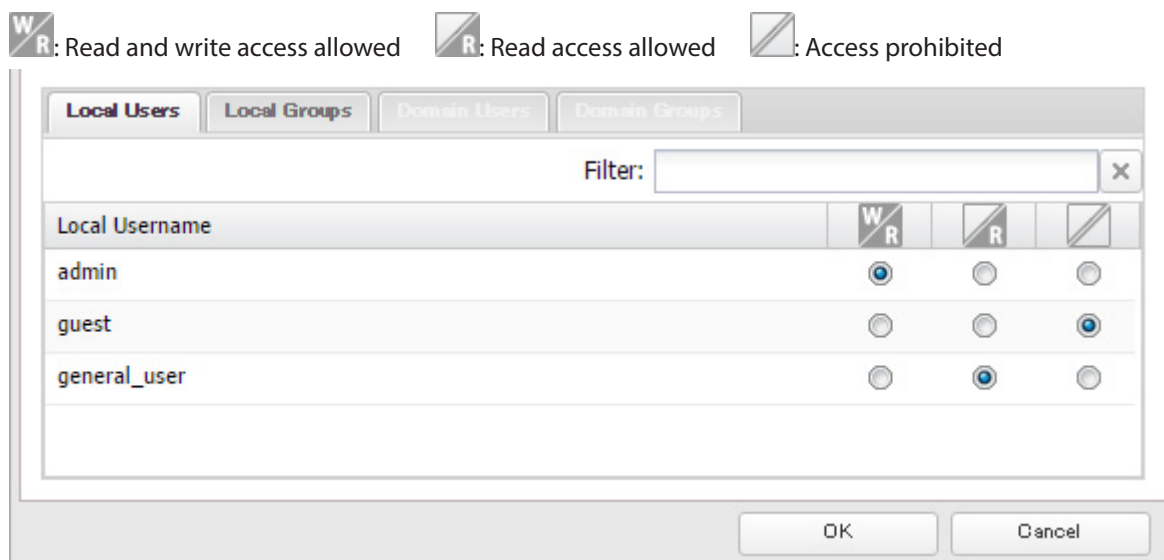

**7** Click *OK*.

**Notes:**

- The example above shows access restriction by user. To restrict access by group, click the *Local Groups* tab and select group permissions.
- If both read-only and read and write permissions are given to a user, the user will have read-only access. The most restrictive access always applies.
- For an access-restricted shared folder, if you change the access restrictions of all users and groups from read and write or read only to access prohibited from the user or group list page in Settings, that shared folder can only be accessed by admin users and groups.

## Active Directory

If there is an Active Directory environment, the TeraStation will use account information from the Active Directory domain controller to set access restrictions for TeraStation's shared folders. There is no need to perform individual account management for the TeraStation. If multiple TeraStations are installed on the network, the account information is centrally managed in Active Directory, greatly reducing the operations required for installation and management.

**Notes:**

- If usernames or group names from Active Directory include multibyte characters, you will not be able to configure access restrictions for them.
- The TeraStation supports a domain environment with a maximum of 1000 users and 1000 groups.

**1** In Settings, click *Network*.

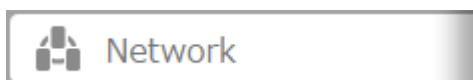

**2** Click  to the right of "Workgroup/Domain".



**3** Click *Edit*.

4 Select "Active Directory", then click *Next*.

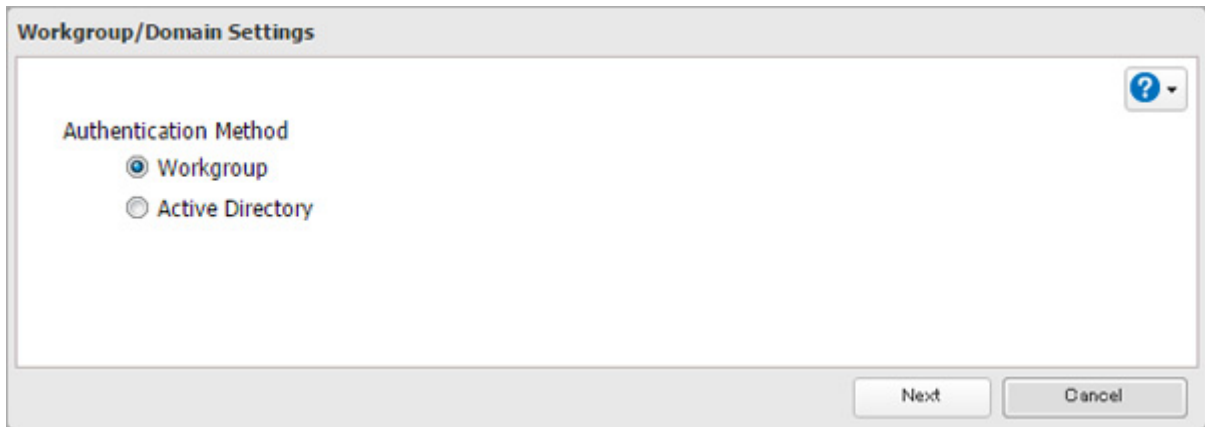

5 Click *Yes*.

6 Enter the desired settings, then click *OK*.

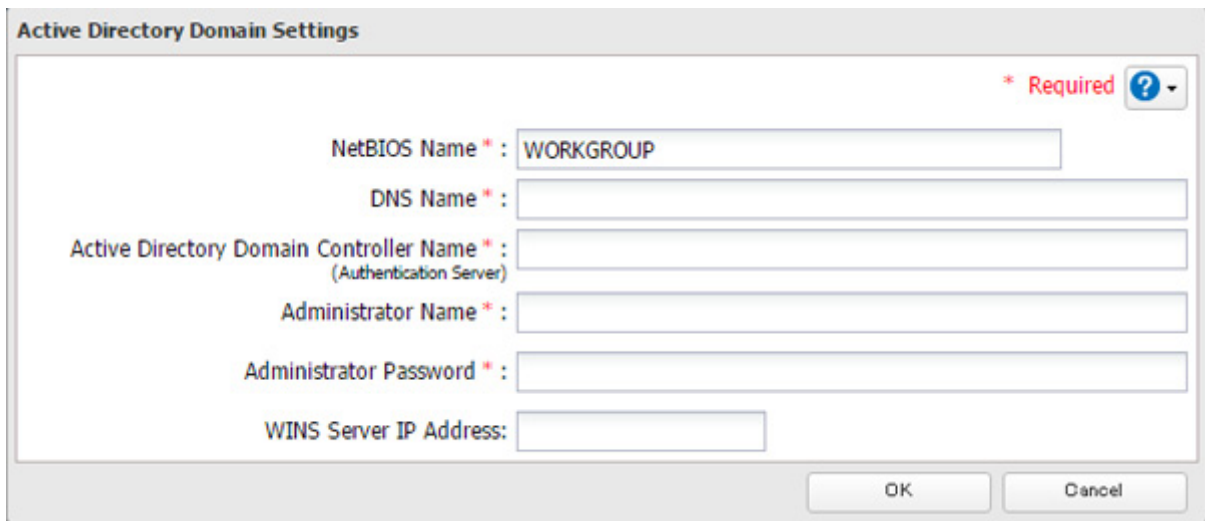

7 Click  to the right of "Folder Setup".



**8** Click a shared folder that you want to set access restrictions for.

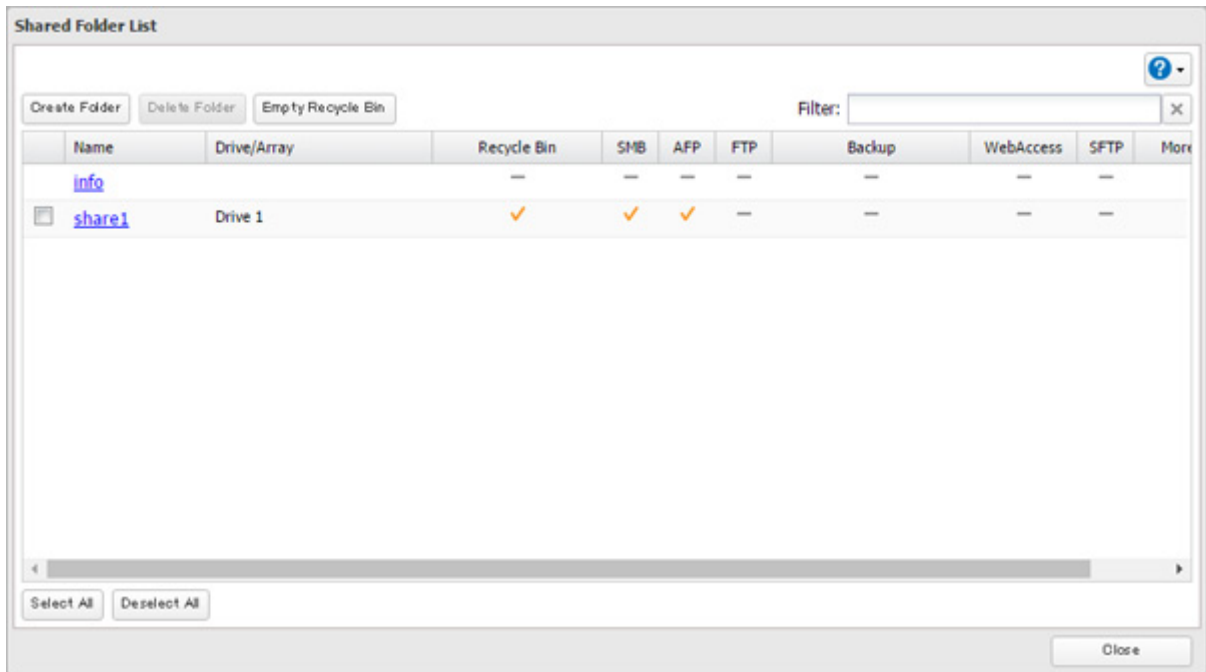

**9** Click *Edit*.

**10** Enable "Access Restrictions".

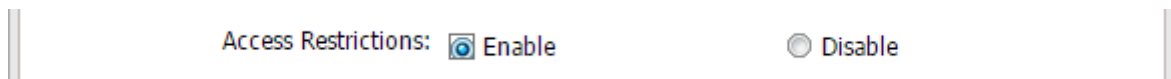

**11** Select the level of access for the user or group.

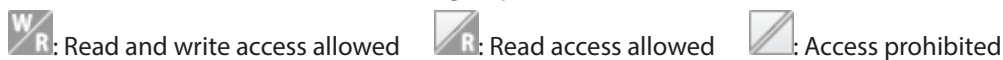

**12** Click *OK*.

**Notes:**

- To have the TeraStation join an Active Directory domain, configure it to use a DNS server that can resolve names for the Active Directory domain.
- After building an Active Directory domain, the administrator password for joining the domain must be changed at least once, or joining the Active Directory domain will fail.
- The DNS name and NetBIOS name of Active Directory domains should be identical.
- If both read-only and read and write permissions are given, the user will have read-only access. The most restrictive access setting will apply.
- If there is a difference of more than 5 minutes between the TeraStation's clock and the domain controller's clock, joining the domain or authenticating domain users and groups may fail. For best results, use an NTP server to set the time for all network devices.
- To use the TeraStation as a member server in an Active Directory domain, the TeraStation should be logged in to the domain and accessed from a computer that is not a member of the domain with a valid domain account.
- If the TeraStation is a member server of an Active Directory domain, you cannot connect as a guest user via AFP.
- If your TeraStation is a member server in an Active Directory domain and you change the authentication method to "Workgroup", the account on the domain controller will not be deleted automatically.
- If FTP is enabled, local and domain group access restrictions from the AD network do not work. Use user access restrictions instead.

- For an access-restricted shared folder, if you change the access restrictions of all users and groups from read and write or read only to access prohibited from the user or group list page in Settings, that shared folder can only be accessed by admin users and groups.

# Chapter 4 Managing Storage

## RAID Modes

TeraStations support many types of RAID. The type of RAID arrays available for use depends on how many drives are installed in your TeraStation.

TeraStation	Default RAID Mode	Available Modes
TS5410DN, TS5410RN	RAID 5	RAID 5, 6, 10, 1, 0, and JBOD
TS5210DN	RAID 1	RAID 1, 0, and JBOD

### Notes:

- If you change the RAID mode, all data on the array is deleted. This is true for every procedure in this chapter. Always back up any important data before performing actions that affect your RAID array.
- Drive capacity is shown in Settings in actual gigabytes. The Properties window in Windows may show GiB instead, which will be a smaller number.
- If the TeraStation is restarted or shut down while changing the RAID mode, the message displayed on the LCD panel will change from I46 or I47 to I18.
- RAID 5, 6, and 10 are only available for 4-drive models.

### RAID 6

RAID 6 arrays are available for TeraStations with 4 or more drives. RAID 6 combines 4 or more drives into a single array. The usable space is equal to the sum of the capacity of all drives minus the capacity of two drives. For example, if 4 drives are combined into a RAID 6 array, the usable space is the sum of the capacity of 2 drives. If 2 drives in the array are damaged, you can recover data by replacing them. If 3 or more drives are damaged, your data is lost.

### RAID 5

RAID 5 arrays are available for TeraStations with 3 or more drives. RAID 5 combines 3 or more drives into a single array. The usable space is equal to the sum of the capacity of the drives minus the capacity of one drive. For example, if 4 drives are combined into a RAID 5 array, the usable space is the sum of 3 drives. If one drive in the array is damaged, you can recover data by replacing the damaged drive. If two or more drives are damaged at the same time, your data is lost.

### RAID 10

RAID 10 arrays are available for TeraStations with 4 or more drives. In this mode, mirrored pairs of drives in RAID 1 arrays are combined into a RAID 0 array. The usable space is equal to the capacity of the smallest drive multiplied by the number of drives divided by 2.

## RAID 1

Combines 2 or more drives into a mirrored array. The available space in the array is the capacity of a single drive. Identical data is written to each drive. If a drive is damaged, data can be recovered by replacing the damaged drive. As long as one drive in the array remains undamaged, all data in the array can be recovered.

## RAID 0

Combines 2 or more drives into a single array. The usable drive space is the total space of all drives used. This simple RAID mode offers faster performance than RAID modes that include parity. If a single drive in the array fails, then all data in the array is lost.

## JBOD

This mode uses the drives inside the TeraStation as individual drives. The drive space you can use is the total capacity of all drives in the TeraStation. If any drive is damaged, then the data on that drive is lost.

---

## Working with RAID Arrays

---

To change RAID settings, navigate to *Storage - RAID* in Settings.

### Using JBOD

---

With JBOD, each drive in the TeraStation is addressed separately. To put drives from an array into JBOD, follow the procedure below.

- 1 In Settings, click *Storage*.



- 2 Click  to the right of "RAID".

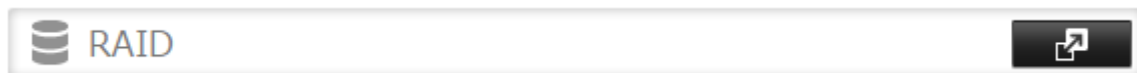

- 3 Click the array to delete.

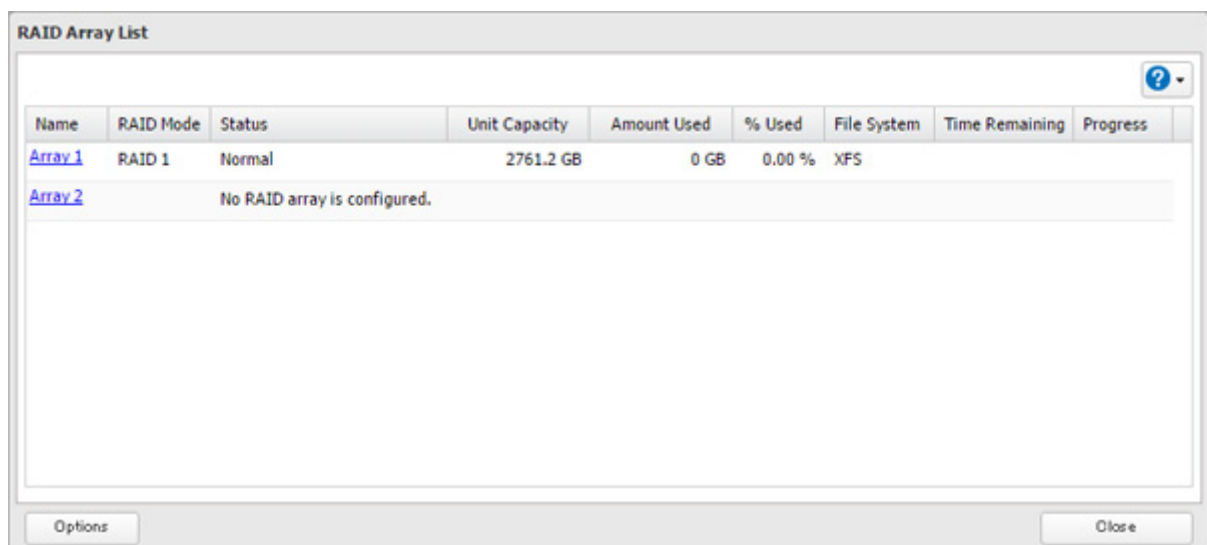

**4** Click *Delete RAID Array*.

**5** The "Confirm Operation" screen will open. Enter the confirmation number, then click *OK*.

**6** Click *OK* when finished.

Once JBOD is configured, create shared folders on each drive to use them.

## Changing RAID Mode

---

To change the RAID mode, first put the drives in JBOD.

**1** In Settings, click *Storage*.



**2** Click  to the right of "RAID".



**3** Click the array to delete.

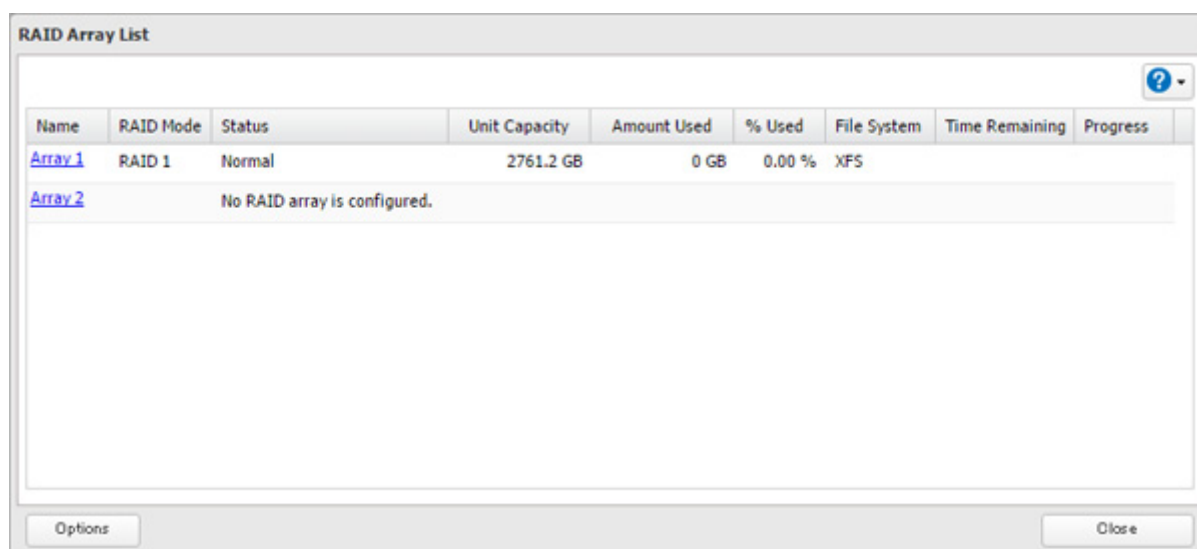

**4** Click *Delete RAID Array*.

**5** The "Confirm Operation" screen will open. Enter the confirmation number, then click *OK*.

**6** Click *OK*.

**7** Choose a RAID array.

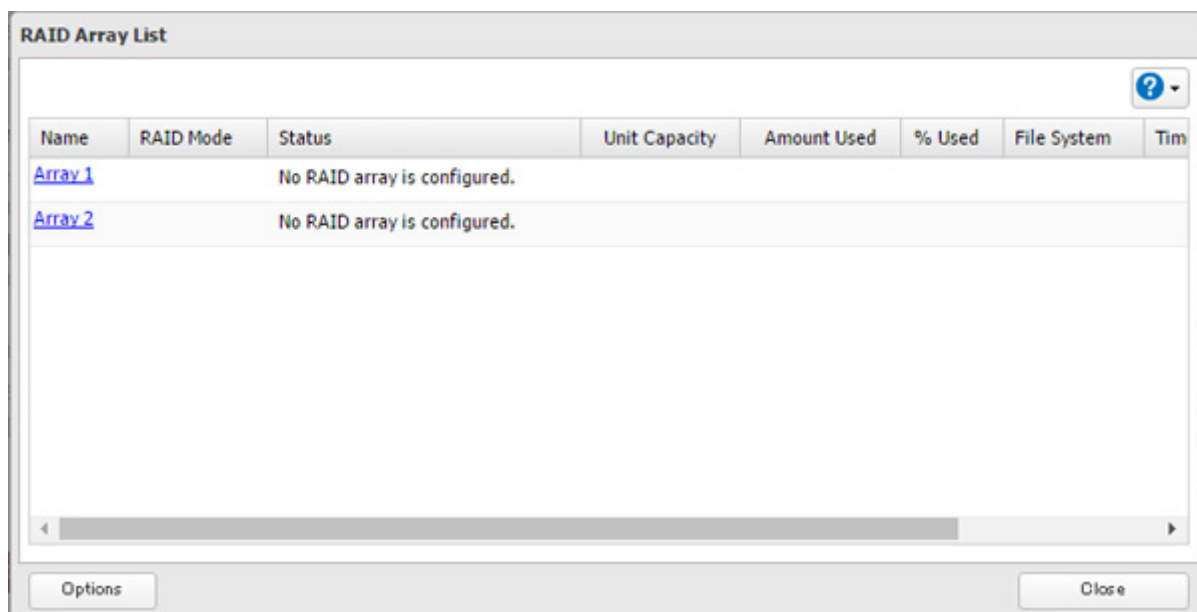

**8** Select a RAID mode and the drives to be used, then click *Create RAID Array*.

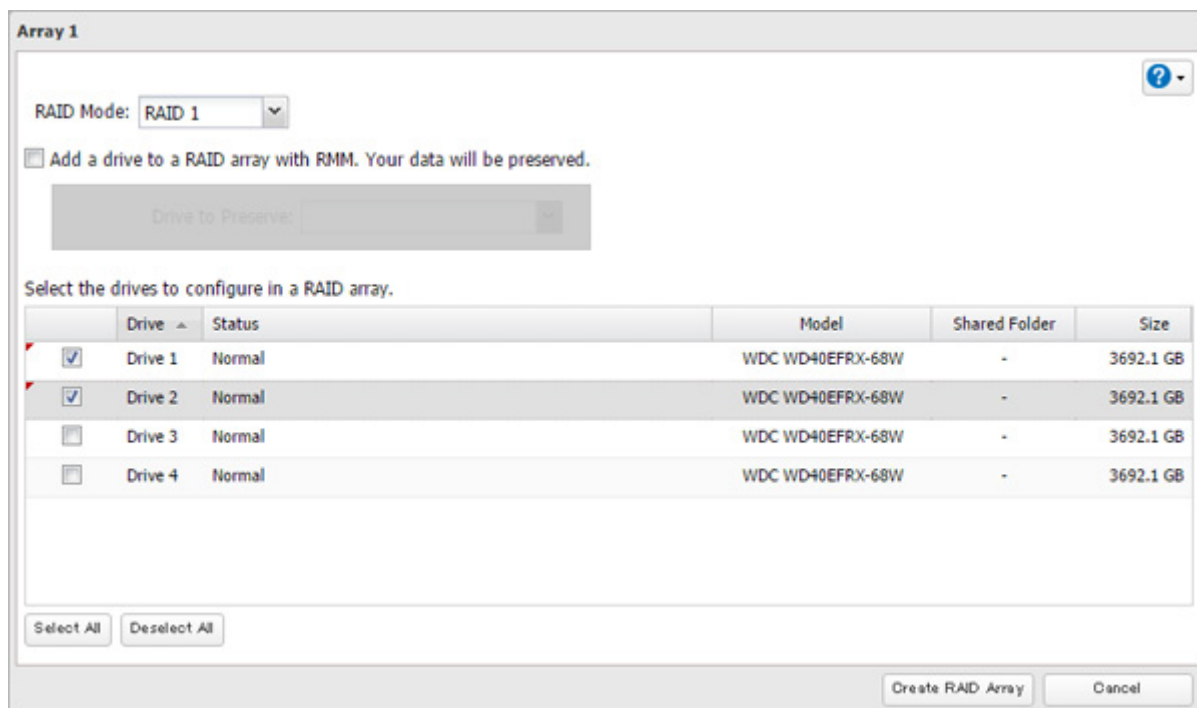

**9** The "Confirm Operation" screen will open. Enter the confirmation number, then click *OK*.

**10** Click *OK* when finished.

**Notes:**

- You can also configure RAID settings from Easy Admin.
- After changing the RAID mode, create a shared folder.

## Configuring a Hot Spare

If you have a hot spare configured and an array fails, the TeraStation immediately switches over to the hot spare. To use a hot spare, you need an extra drive that's not part of any array and a RAID 1 or RAID 5 array.

**Notes:**

- All data on the hot spare drive is deleted when it is configured as a hot spare and again when it changes from a spare to a drive in the array.
- A hot spare cannot be configured for TeraStation models with only two drives. Use RAID 1 instead.

**1** In Settings, click *Storage*.



**2** Click  to the right of "RAID".



**3** Choose a RAID array.

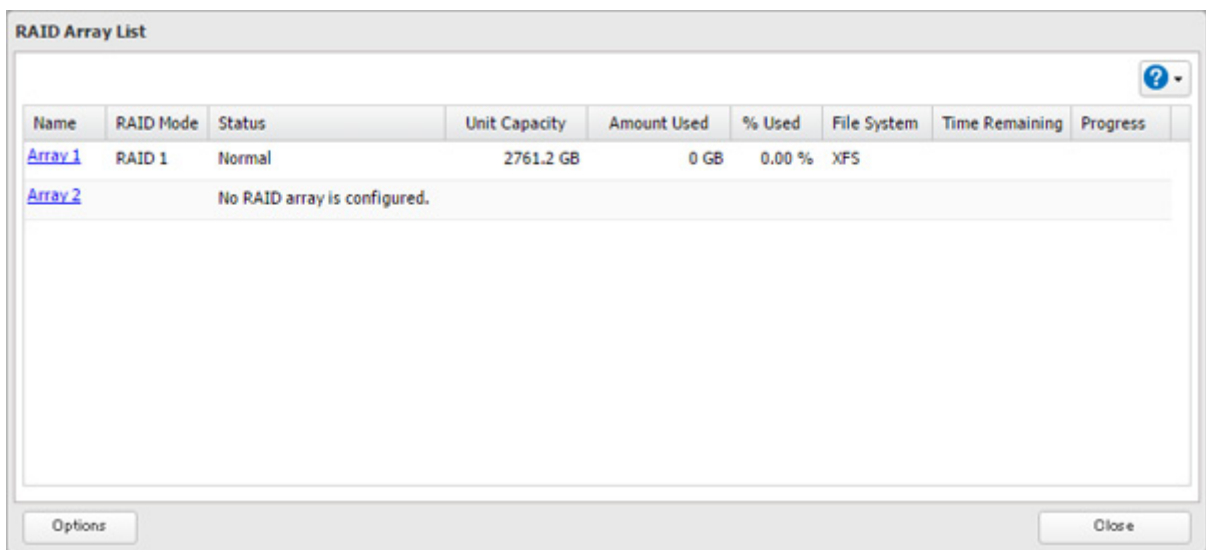

**4** Click *Set as a hot spare*.

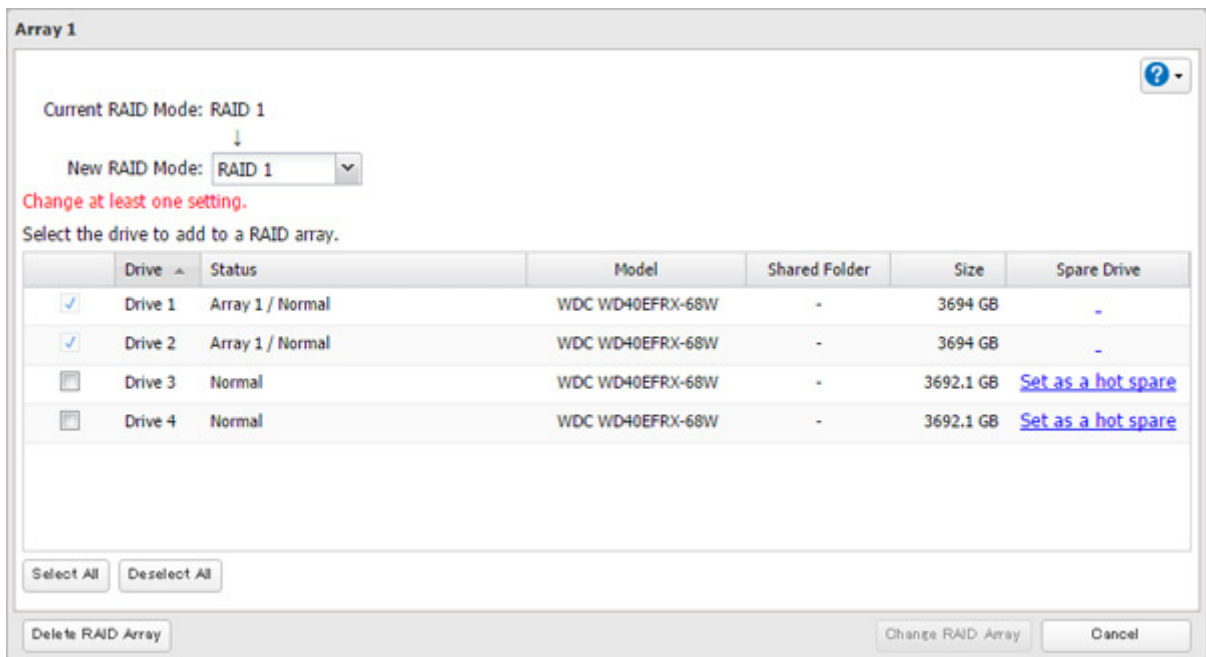

**5** Click Yes.

**6** The "Confirm Operation" screen will open. Enter the confirmation number, then click *OK*.

**7** Click *OK* when finished.

**Note:** To turn the hot spare back into a normal drive, choose *Set as a normal drive*.

## RMM (RAID Mode Manager)

---

With RMM, you can create or expand a RAID array without erasing the data on the drives.

### Changing from JBOD to RAID 1

You must have at least two drives available in JBOD (not in a RAID array) to build the RAID 1 array with RMM.

**1** In Settings, click *Storage*.



**2** Click  to the right of "RAID".

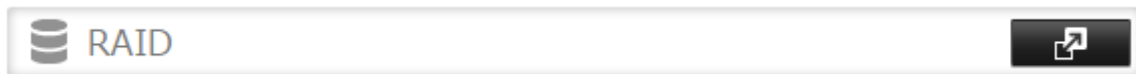

**3** Choose a RAID array.

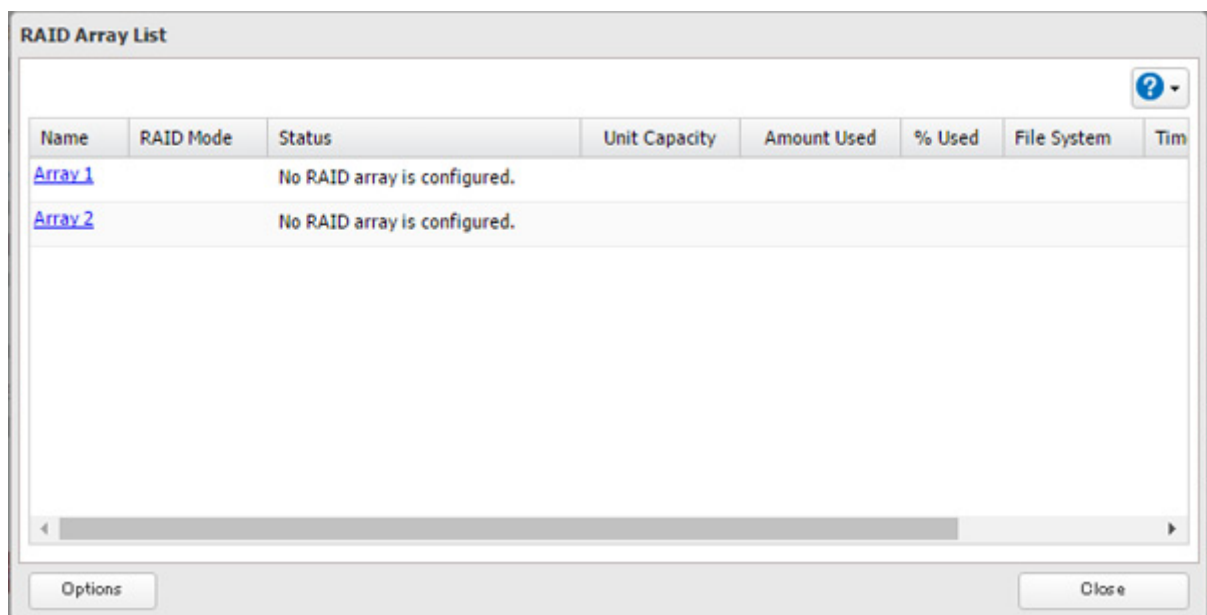

**4** Set the RAID mode to "RAID 1".

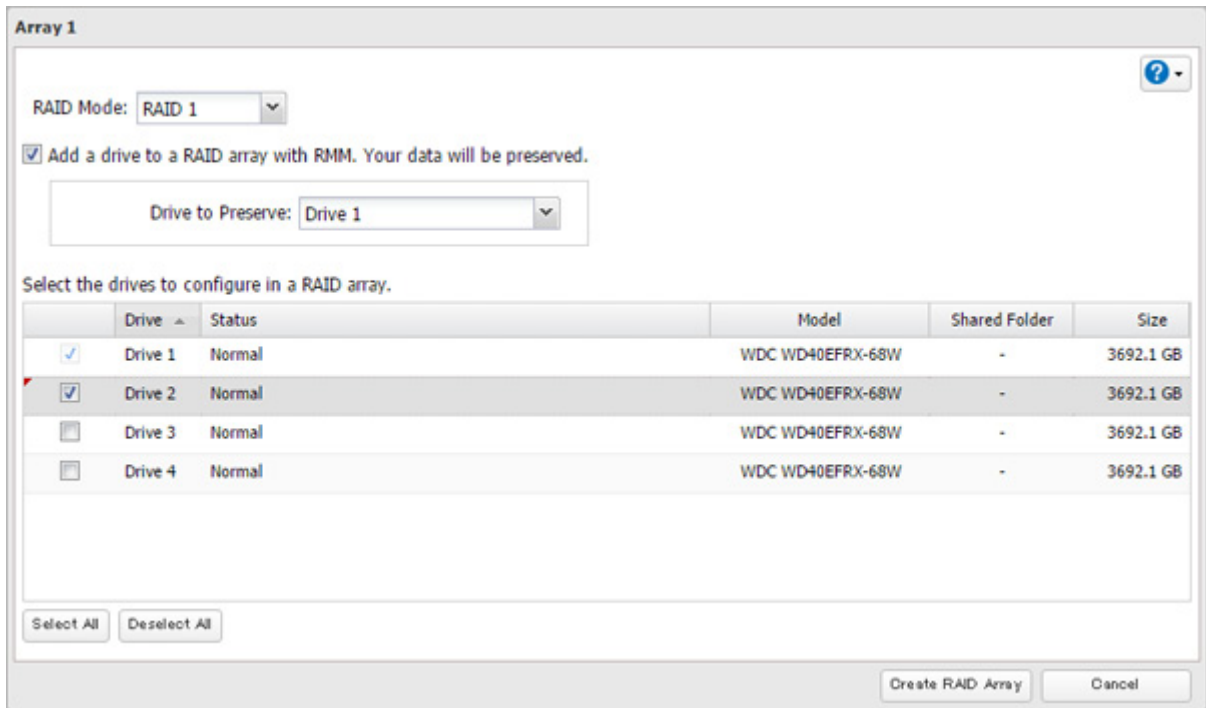

**5** Select the "Add a drive to a RAID array with RMM. Your data will be preserved." checkbox.

**6** Select the drive whose data will be saved from the drop-down list.

**7** Select the drive to add to the RAID array.

**8** Click *Create RAID Array*.

**9** The "Confirm Operation" screen will open. Enter the confirmation number, then click *OK*.

**10** Click *OK* when finished.

## Adding a Drive to an Existing RAID Array

You can add a drive to a RAID 1 or RAID 5 array. Drives in JBOD can be added to the RAID array.

**Note:** RMM can be used to expand an array by one drive per operation. To expand by two or more drives, RMM must be performed multiple times.

**1** In Settings, click *Storage*.



**2** Click  to the right of "RAID".



**3** Choose a RAID array.

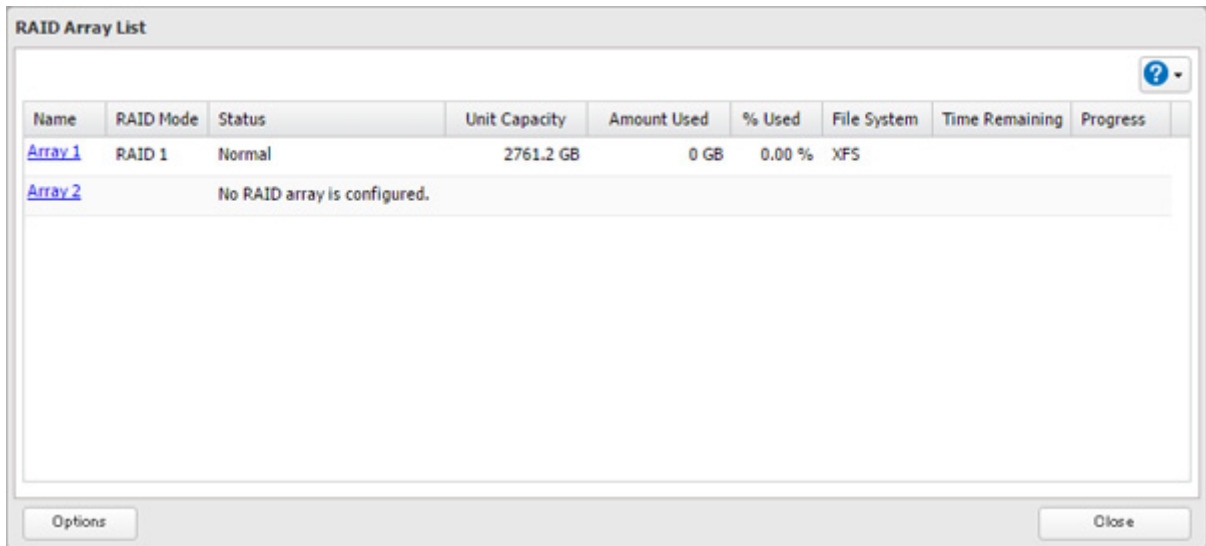

**4** Select the drive to add to the RAID array.

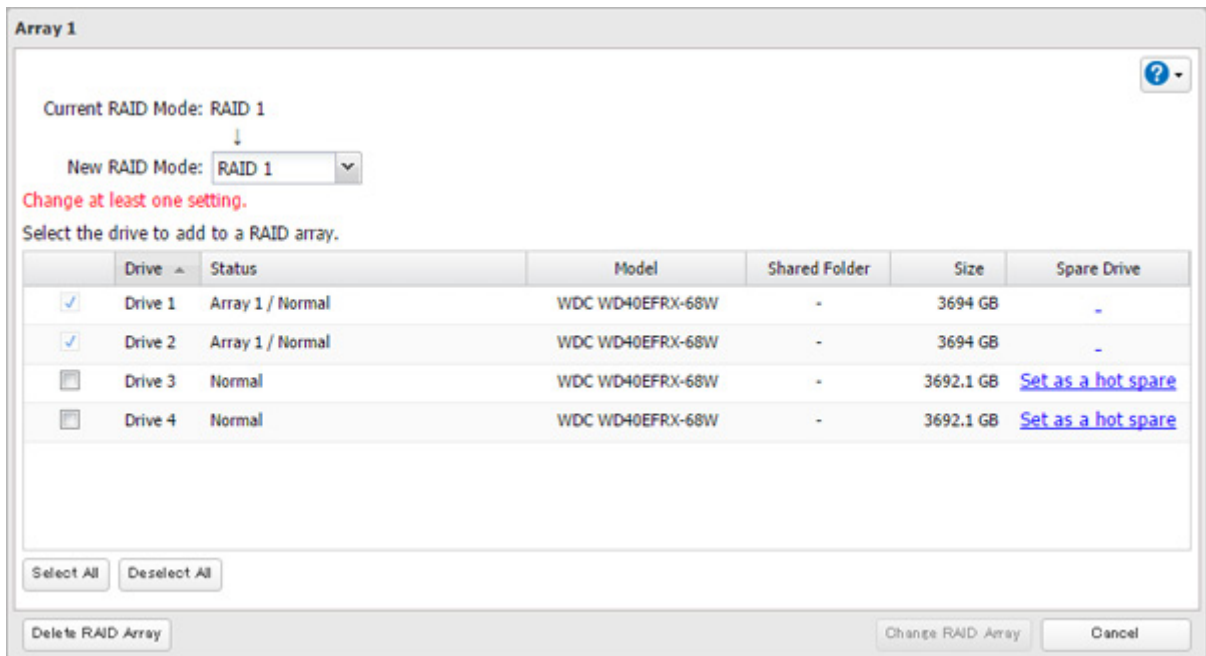

**5** Click *Create RAID Array*.

**6** The "Confirm Operation" screen will open. Enter the confirmation number, then click *OK*.

**7** Click *OK* when finished.

## Changing the RAID Mode While Adding a Drive

Select the drive you want to add to the RAID array and choose the mode for the array. Enter the "Confirm Operation" number and click *OK*.

## RAID Scanning

A RAID scan checks you RAID array for bad sectors and if it finds any, it automatically repairs them. Arrays other than RAID 0 are supported. For best results, run a RAID scan regularly.

1 In Settings, click *Storage*.



2 Move the RAID scanning switch to the  position to enable RAID scanning.



3 Click  to the right of "RAID Scanning".

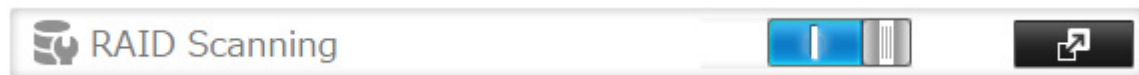

4 Click *Edit*.

5 Select when to run the scan and click *OK*.

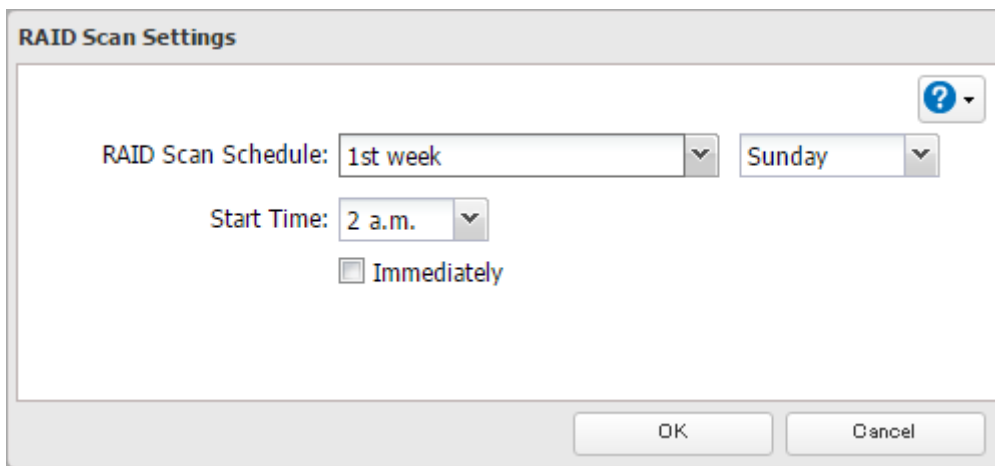

**Notes:**

- Select the "Immediately" checkbox to run a RAID scan immediately.
- To stop a RAID scan, click *Cancel RAID Scan*.

---

## Adding an External Drive

---

### Connecting an External Drive

---

Your TeraStation includes USB ports (the number of ports depends on your model), and you can connect external drives to these ports. Once connected, they appear as shared folders on the TeraStation. Formatted drives are detected automatically. Unformatted drives should be formatted in Settings.

After a USB drive is recognized, Windows adds "usbdisk x" under the TeraStation in "Network", where "x" is the USB port where the drive is connected.

### Compatibility

---

The following USB devices are supported by the TeraStation:

- USB storage devices
- Card readers (except for card readers that can recognize two or more memory cards)

Buffalo external USB drives are recommended.

Supported file systems for external drives are below:

- FAT32
- EXT3
- XFS
- NTFS
- HFS Plus (read-only)
- exFAT

Connect only one device to each USB port of the TeraStation. Note that only the first partition of a connected USB drive is mounted. Additional partitions are not recognized.

**Notes:**

- Backup data from macOS may include characters that cannot be written to FAT16 or FAT32 drives such as ".DS\_Store". For best results, reformat the drive before using it as a backup target.
- If your USB 3.0 drive is not reconfigured after rebooting the TeraStation, unplug and reconnect it.
- When copying a file that is over 100 MB to a FAT32-formatted USB drive using File Explorer, an error message may be displayed. In such a case, use an FTP or SFTP connection to copy the file.

## Dismounting Drives

If the TeraStation is powered on, dismount drives (internal and external) before unplugging them. You may dismount external drives with the function button, or any drive from Settings. If the TeraStation is off, then all drives are already dismounted and may be unplugged safely.

**Note:** Do not dismount internal drives while a RAID array is rebuilding or RMM is being configured. If you do, data on the drives may be lost.

### Dismounting with the Function Button

When you press the function button, the TeraStation will beep once. Press and hold the button until the TeraStation beeps again and the button starts blinking blue. It will take about 6 seconds. When the dismount is finished, the function button will stop blinking and return to glowing. You may now unplug any USB drives safely.

After 60 seconds, the function button will go out and any drives that have not yet been unplugged will be remounted.

### Dismounting from Settings

**1** In Settings, click *Storage*.



**2** Click *Drives* to dismount an internal drive or *USB Drives* to dismount an external drive.



**3** Select the drive to dismount and click *Dismount Drive*.

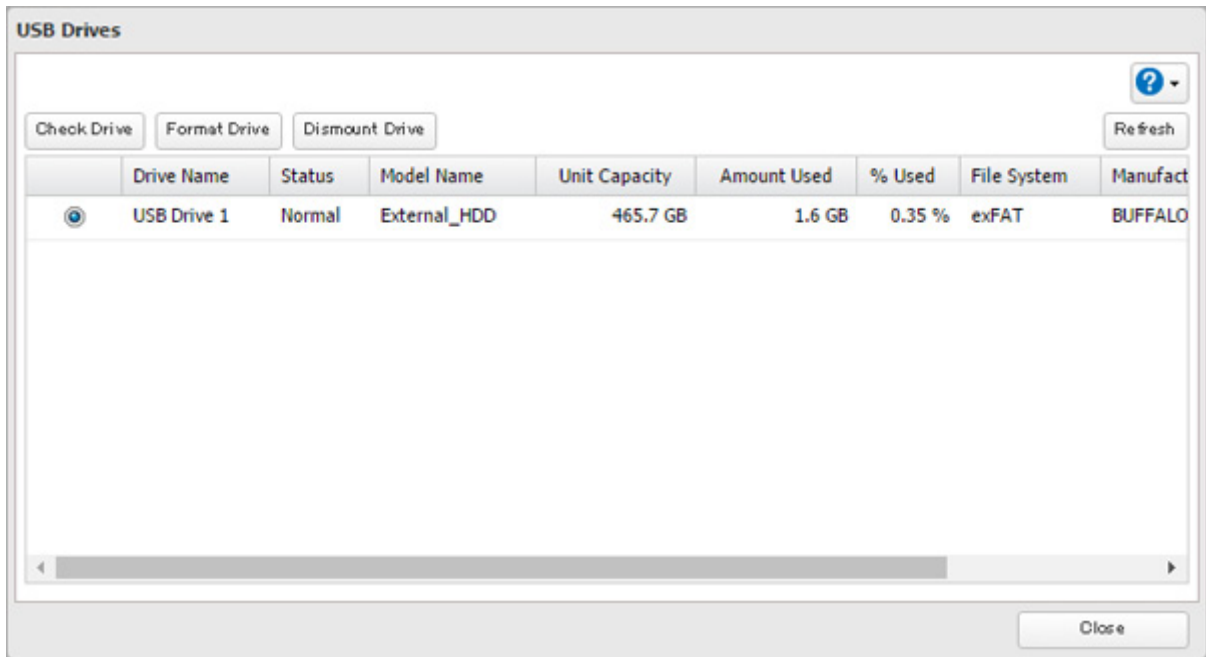

**4** When the following message is displayed, it is safe to unplug the drive.

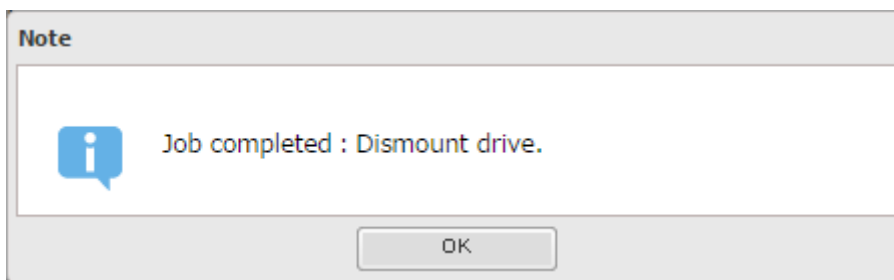

**Note:** To remount the drive, unplug it and then plug it back in.

---

## Checking Drives

---

A drive check tests the data on a drive in the TeraStation or one that is connected via USB for integrity. Errors are fixed automatically. With large drives, a drive check may run for many hours. Shared folders cannot be accessed during a drive check. Do not turn off the TeraStation until the drive check is finished. Use the procedure below to run a drive check.

**1** In Settings, click *Storage*.



**2** Select *Drives* to check an internal drive or *USB Drives* to check an external drive.



**3** Select the drive or array to test, then click *Check Drive*.

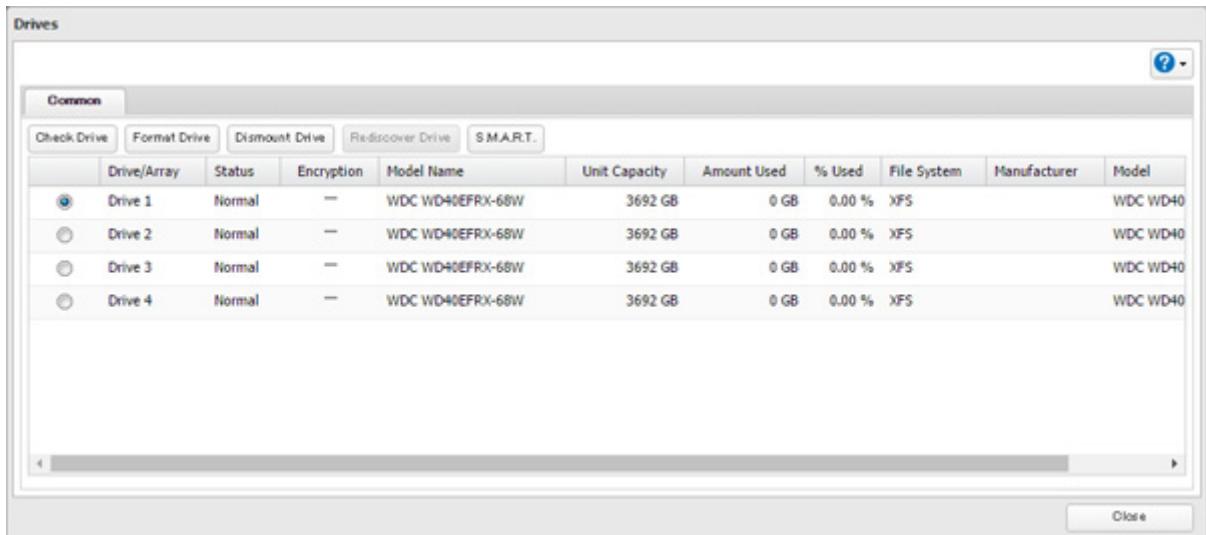

**4** Click *Check*. You have the option of deleting information files from macOS during the check if desired.

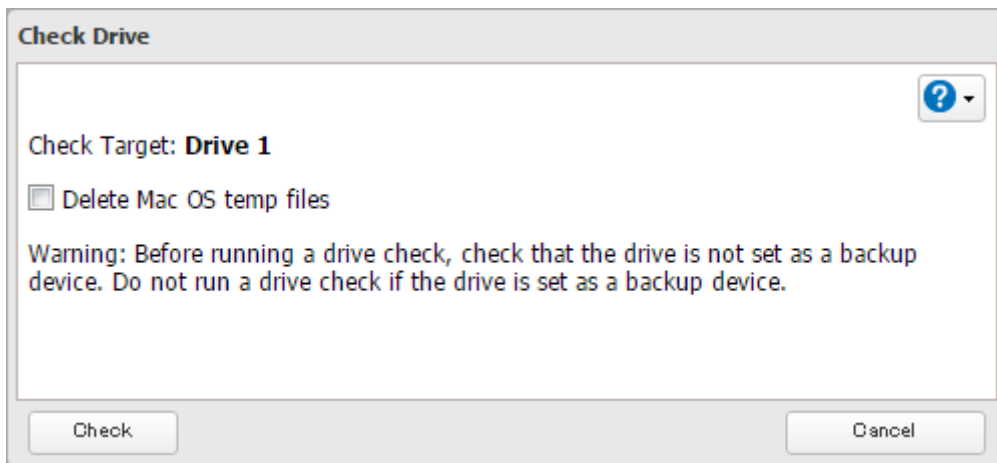

---

## S.M.A.R.T.

---

S.M.A.R.T. (Self-Monitoring, Analysis, and Reporting Technology) monitors internal drives to detect and report various indicators of reliability, in the hope of anticipating failures. When a failure is anticipated by S.M.A.R.T., the user may choose to replace the drive to avoid outages and data loss. Follow the procedure below to check S.M.A.R.T. information for the TeraStation's internal drives.

**Note:** S.M.A.R.T. information is only available for internal drives.

**1** In Settings, click *Storage*.



**2** Click  to the right of "Drives".



**3** Select a drive to check and click *S.M.A.R.T.*

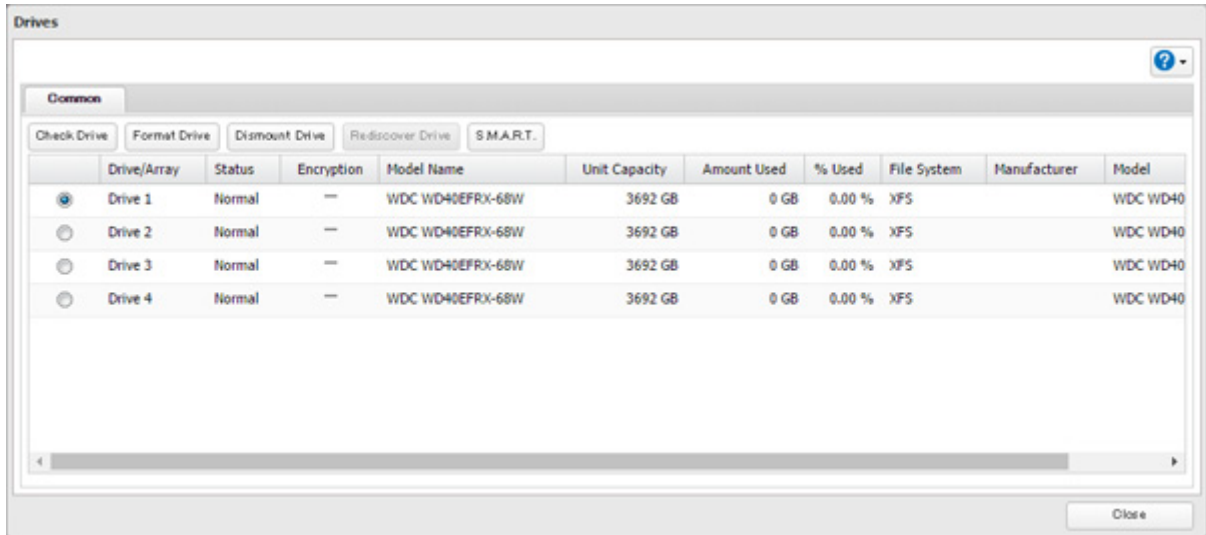

**4** The S.M.A.R.T. information for the drive will be displayed. Different information may be displayed depending on the brand of drives in your TeraStation. Critical attributes are displayed in bold. Attributes with current value less than or equal to the threshold value may be significant. If an attribute reports a failure, or has had one in the past, it will be displayed in the status column.

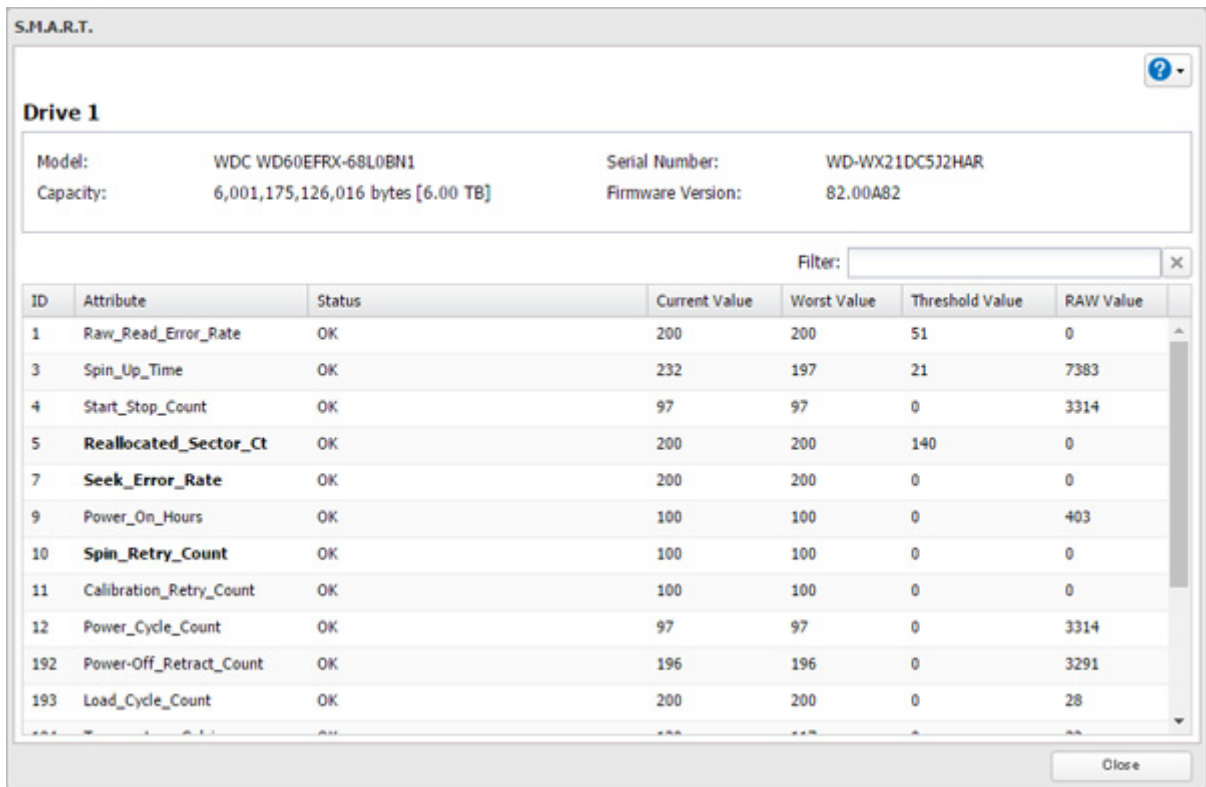

## Formatting Drives

**Notes:**

- Under some circumstances, data deleted when a drive is formatted can be recovered. To ensure that data is "gone forever", a format might not be sufficient. See the "Erasing Data on the TeraStation Completely" section below.
- After a drive is formatted, the "% Used" and "Amount Used" in Settings will not be 0. This is because some drive space is used for the system area.

1 In Settings, click *Storage*.



2 Select *Drives* to format an internal drive or *USB Drives* to format an external drive.



3 Select the drive or array to format, then click *Format Drive*.

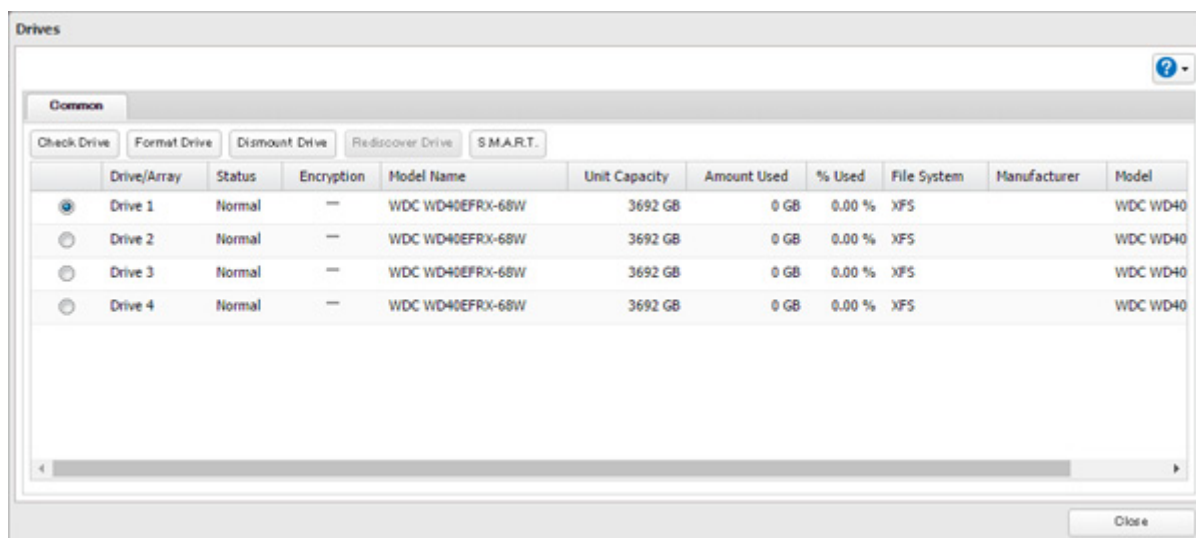

4 Select a format type, then click *Format*.

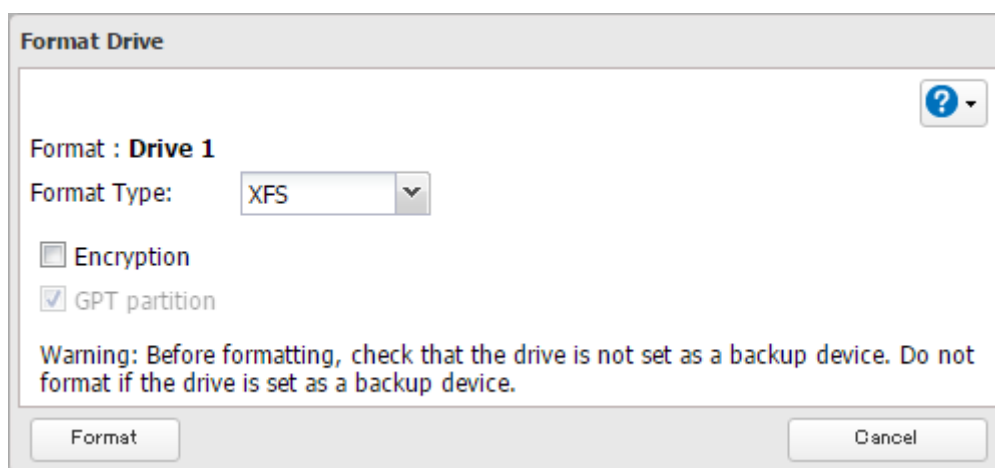

5 The "Confirm Operation" screen will open. Enter the confirmation number, then click *OK*.

6 Depending on the size and the formatted file system of your drive, the format may take several minutes or several hours to complete. "Formatting" will be displayed on the LCD panel until the format is complete. Click *OK* when finished.

**Notes:**

- Do not turn off or disconnect power to the TeraStation while formatting a drive.
- For drives of 2.2 TB or larger, make sure that the "GPT partition" checkbox is selected.

---

## Encrypting Drives

---

Internal drives (and arrays) can be encrypted with 128-bit AES during formatting. Encrypted drives and arrays are then readable only from that specific TeraStation. To decrypt a drive or array, clear the "Encryption" checkbox and format it again.

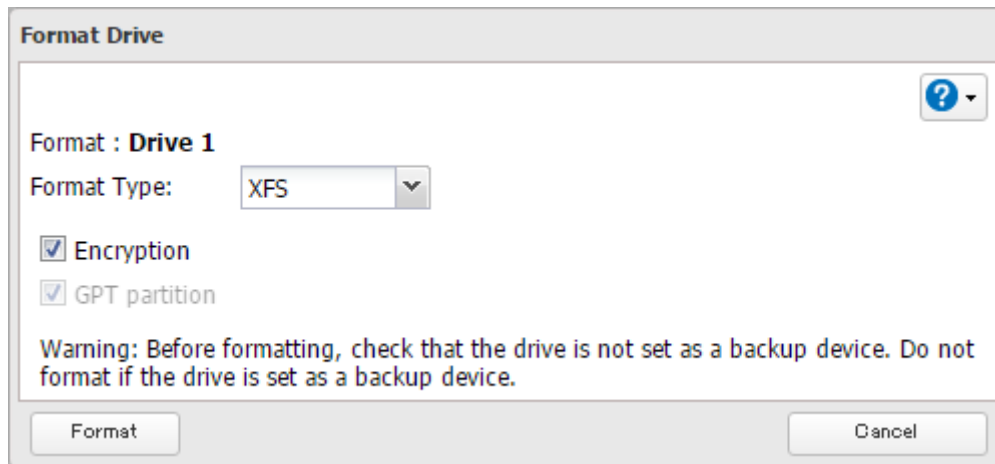

---

## Erasing Data on the TeraStation Completely

---

Under some circumstances, data from formatted drives can be recovered. The drive erasure process in this section does a much more thorough job of erasing data. This procedure is recommended for removing all data from a drive in a way that makes it nearly impossible to recover with current tools. The TeraStation will then be in the following state:

- All drives in JBOD
- An empty shared folder on each drive
- All settings returned to their default values
- All logs deleted

If you remove a drive and then erase all data on the TeraStation, the LCD panel will show the E22 error message and the number of the removed drive. You can still use the TeraStation.

Follow the procedure below to completely and permanently erase all data from your TeraStation.

**1** In Settings, click *Management*.

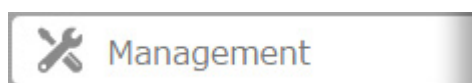

**2** Click  to the right of "Restore/Erase".



**3** Click *Erase TeraStation*.

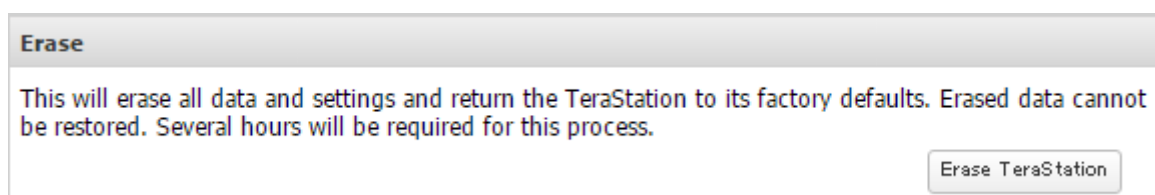

**4** The "Confirm Operation" screen will open. Enter the confirmation number, then click *OK*.

**5** All data on the TeraStation will be permanently erased.

---

## Drive Quotas

---

You can set a drive quota to limit drive space for each user or group. You can also set a threshold. If the drive space exceeds the set threshold, an email notification will be sent. To configure email notifications for drive quota, refer to the "Email Notification" section in chapter 7.

**Notes:**

- When using quotas, disable the recycle bin or empty the trash folder often. The limited space includes the space used for trash.
- Quotas apply per drive or per array. If a quota is set to 1 GB, each array or drive can use a maximum of 1 GB.
- Quotas cannot be set for external drives connected to the TeraStation.
- If both user and group quotas are configured for a user, the most restrictive quota will always apply.

---

## Quotas for Users

---

Follow this procedure to limit the shared folder drive space available for a user.

**1** In Settings, click *File Sharing*.

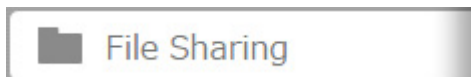

**2** Click  to the right of "Users".



**3** Select the user whose space will be limited.

**4** Enable quotas, choose the maximum space the user will be allowed to use, and click *OK*.

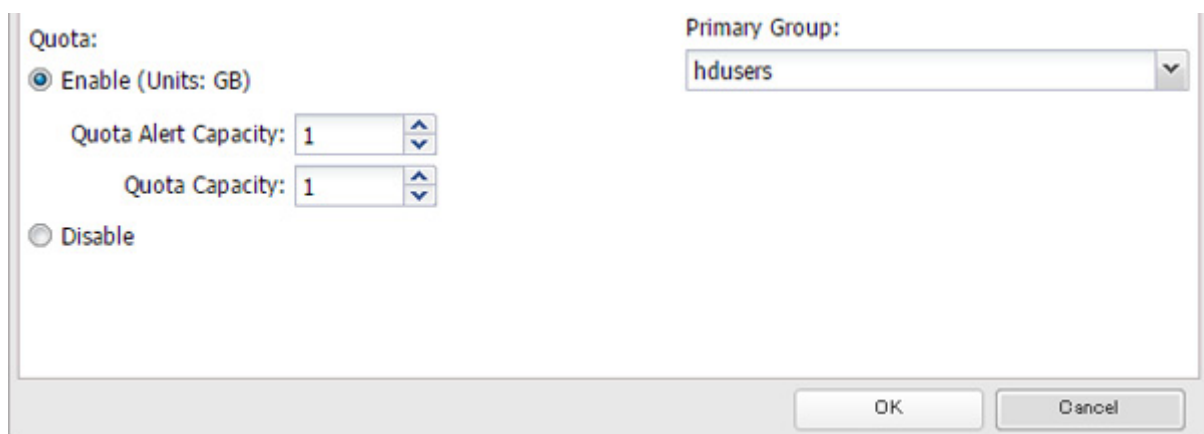

**Note:** If you change the primary group, restart the TeraStation to apply the quota settings.

**5** Click *OK*.

---

## Quotas for Groups

---

Follow the procedure below to limit the space for shared folders that each group can use.

**1** In Settings, click *File Sharing*.

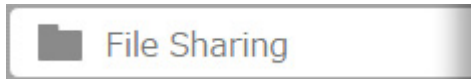

**2** Click  to the right of "Groups".



**3** Select the group whose space will be limited.

**4** Enable quotas, choose the maximum space the group is allowed, and click *OK*.



**5** Click *Close*.

**6** Click  to the right of "Users".

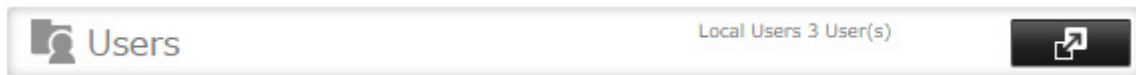

**7** Select the user who will inherit the group quota settings.

**8** Change the user's primary group to the group with the quota, then click *OK*.

**9** Click *OK*.

## Size Limits

---

If LVM is enabled, volumes can be created with maximum size limits.

**Note:** When creating a LVM volume, all data in the area where you specified for the LVM volume will be erased. Before changing any settings, back up any important data.

**1** In Settings, click *Storage*.



**2** Click  to the right of "LVM".



**3** Select the drive or array where the volume will be located and click *Enable LVM*.

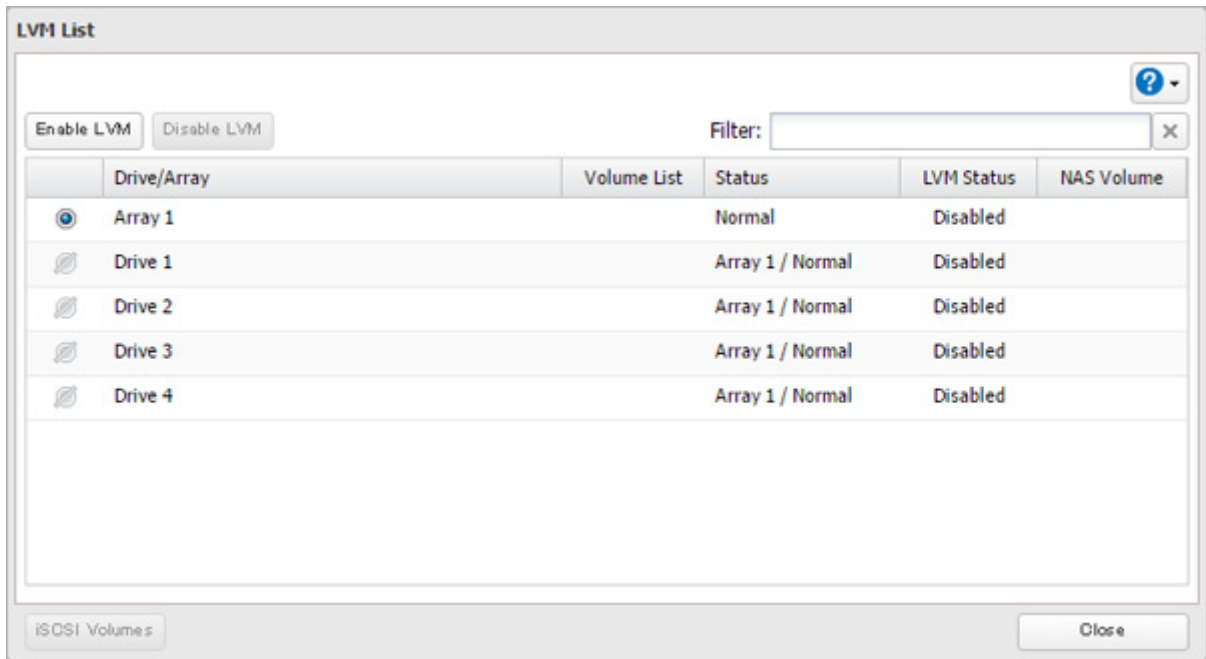

**4** The "Confirm Operation" screen will open. Enter the confirmation number, then click *OK*.

**5** Click *OK*.

**6** Click *Edit* under "NAS Volume".

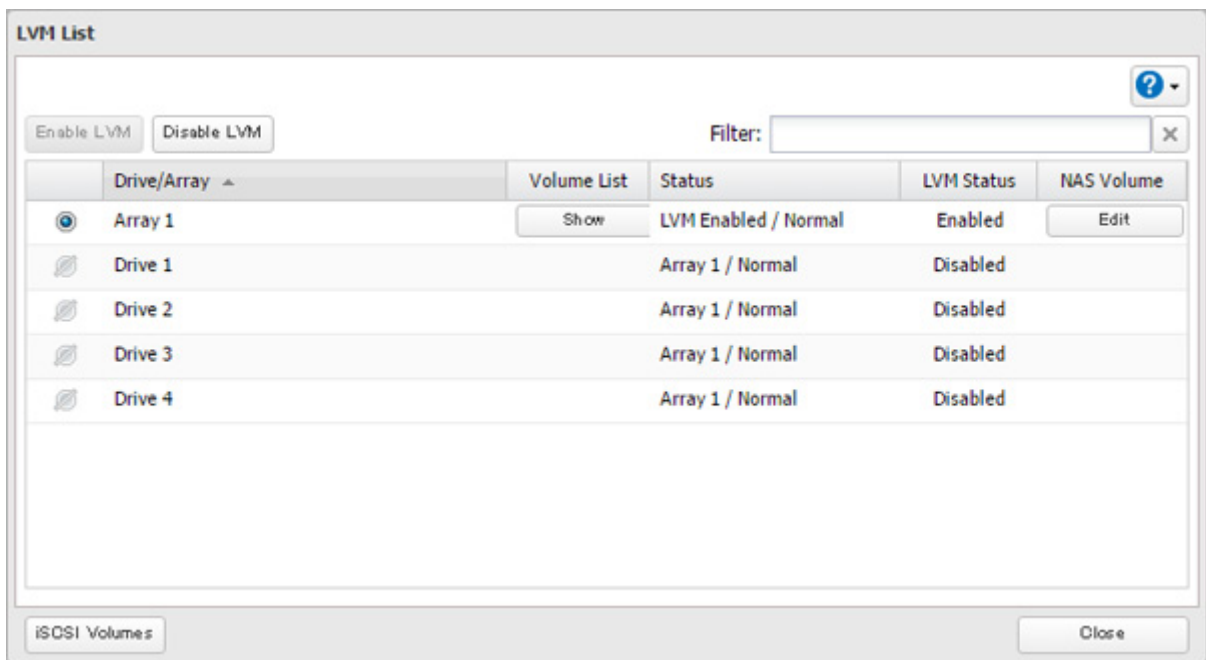

**7** Click *Create Volume*.

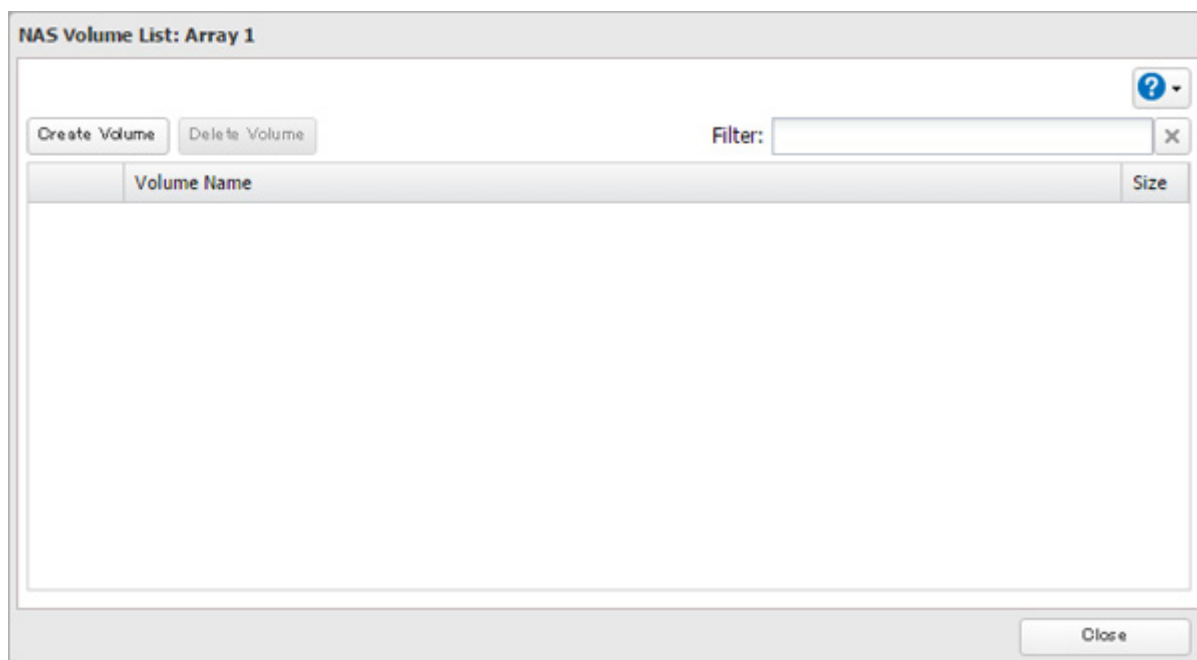

**8** Configure the desired settings, then click *OK*.

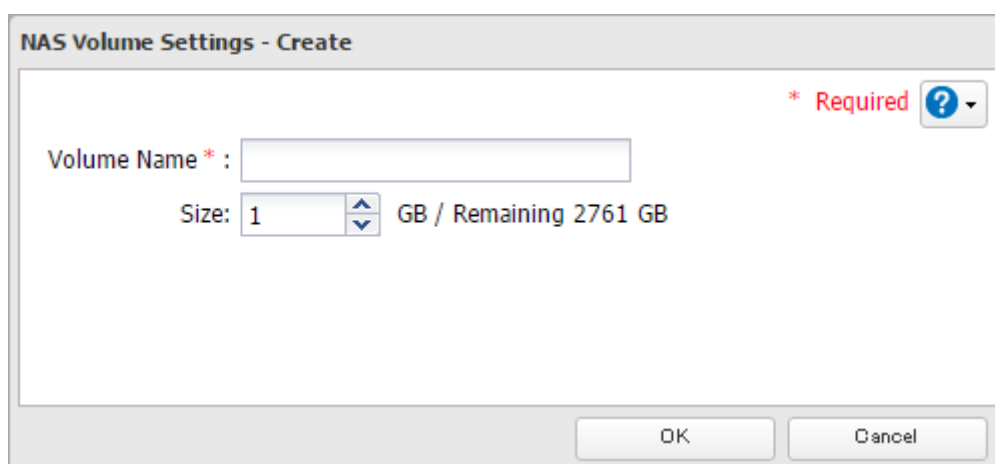

**9** Click *OK*.

**10** Click *Close*.

**11** Click *Close*.

**12** Navigate to *File Sharing - Folder Setup*.



**13** Click *Create Folder*.

**14** Configure the settings.

**15** Select the volume that you created and click *OK*.

**Notes:**

- Do not use any of the following words for the name of a volume as these words are reserved for internal use by the TeraStation: array x, authtest, disk x, global, homes, info, lost+found, lp, mediacartridge x, msdfs\_root, mt-daapd, printers, ram, spool, usbdisk x. Any instances of "x" denote a number (for example: array1 or disk3)
- If an LVM volume could not be mounted, try restarting the TeraStation. If an issue still exists, delete and recreate the LVM volume. Deleting the LVM volume will erase data on the volume.

---

## Using the TeraStation as an iSCSI Device

---

### Introduction

---

iSCSI is a protocol for carrying SCSI commands over IP networks. Unlike traditional SAN protocols such as Fibre Channel, which requires special-purpose cabling, iSCSI can be run over long distances using existing network infrastructure. Normal Windows formatting such as NTFS is supported.

### Differences Between NAS and iSCSI

With iSCSI, the TeraStation is connected to a single computer, such as a server. Other computers on the network access files on the TeraStation through the computer it's connected to. The TeraStation can be used as a local drive from Windows Server. Features of Windows Server such as Active Directory can be used normally.

As a NAS, the TeraStation is a server, and computers (including other servers) on the network can access shared folders on it directly. A separate server is not required, and features such as backup are built-in.

### Network Configuration

Use gigabit or faster network equipment with iSCSI. For best results, a dedicated network for iSCSI is recommended, separate from the regular network. Use fixed IP addresses for storage devices such as the TeraStation.

### Connection Tool

The Microsoft iSCSI Software Initiator is already installed on your computer. You don't need to download and install it.

## Creating an iSCSI Volume

---

To use the TeraStation as an iSCSI drive, create a volume first. Configure the TeraStation as described below.

**Notes:**

- If the volume settings are changed, all data on the volume will be erased. Before changing any settings, back up any important data.
- The TeraStation can have up to 255 volumes, but we recommend creating no more than 32. Exceeding this volume amount may cause irreparable damage to the unit.
- Do not use any of the following words for the name of a volume as these words are reserved for internal use by the TeraStation: array x, authtest, disk x, global, homes, info, lost+found, lp, mediacartridge x, msdfs\_root, mt-daapd, printers, ram, spool, usbdisk x. Any instances of "x" denote a number (for example: array1 or disk3)

**1** In Settings, click *Storage*.



**2** Move the iSCSI switch to the  position to enable iSCSI.



**3** Click  to the right of "iSCSI".

**4** Click *Create Volume*.

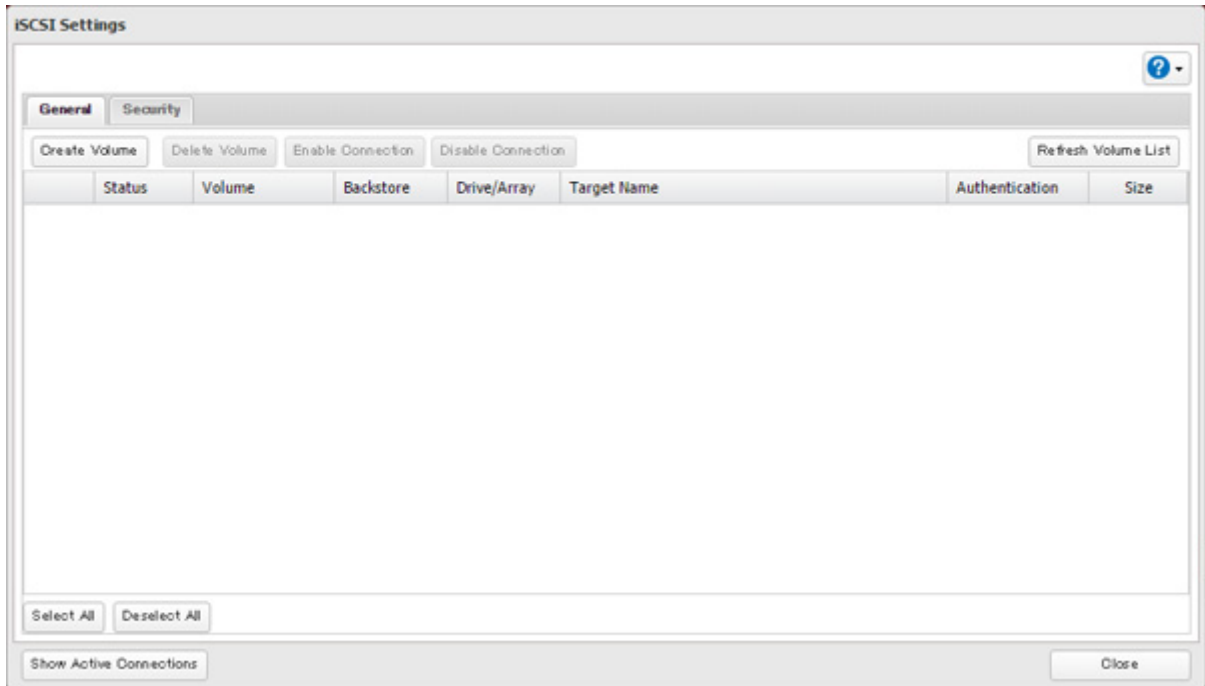

**5** Enter a volume name, volume description, drive or array where a volume will be created, and enter a volume size. Click *OK* when finished.

If you enabled LVM for the target drive or array, or selected "File I/O" for the "Backstore" option, the volume size that you specify here can be changed later. To change the volume size, refer to the "Expanding Volume Sizes" section below.

The screenshot shows a dialog box titled "Creating iSCSI Volume". It has a "General" tab and an "Authentication" section. In the "General" section, "Backstore" is set to "File I/O", "Volume Connection" is "Enable", "Volume \*" is an empty field, "Volume Description" is an empty text box, "Drive/Array" is "Array 1 (LVM disabled) / 11079 GB", and "Size" is "1 GB / Remaining 11078 GB". In the "Authentication" section, "Authentication" is "Enable", "Target CHAP Name \*" is an empty field, "Target CHAP Secret \*" is an empty field, "Mutual Authentication" is checked, and "Initiator CHAP Secret" is an empty field. There is also a "Disable" radio button. At the bottom, there are "Advanced Settings", "OK", and "Cancel" buttons.

**6** The "Confirm Operation" screen will open. Enter the confirmation number, then click *OK*.

**7** Click *OK*, then *Close*.

**Note:** If you click *Disable Connection* for the selected volume in *Storage - iSCSI* in Settings, the selected iSCSI volume can no longer be accessed. If you click *Enable Connection*, the volume will become accessible from the iSCSI initiator software.

## Connecting or Disconnecting Volumes

**Note:** By default, the IP address of the TeraStation is automatically assigned from a DHCP server. However, in this case, if you turn off and restart the TeraStation, the IP address may be changed and the volumes on the TeraStation may not be accessible. To avoid changing the IP address unexpectedly, using a fixed IP address for the TeraStation is recommended.

### Connecting Volumes

To connect a volume, follow the procedure below.

**Note:** Do not shut down the TeraStation while connecting to an iSCSI volume. It may cause unexpected data erasure. Make sure all connections are disconnected before shutdown.

**1** In Windows, navigate to *Control Panel - Administrative Tools - iSCSI Initiator*.

**2** Enter the IP address of the TeraStation into the "Target" box and click *Quick Connect*.

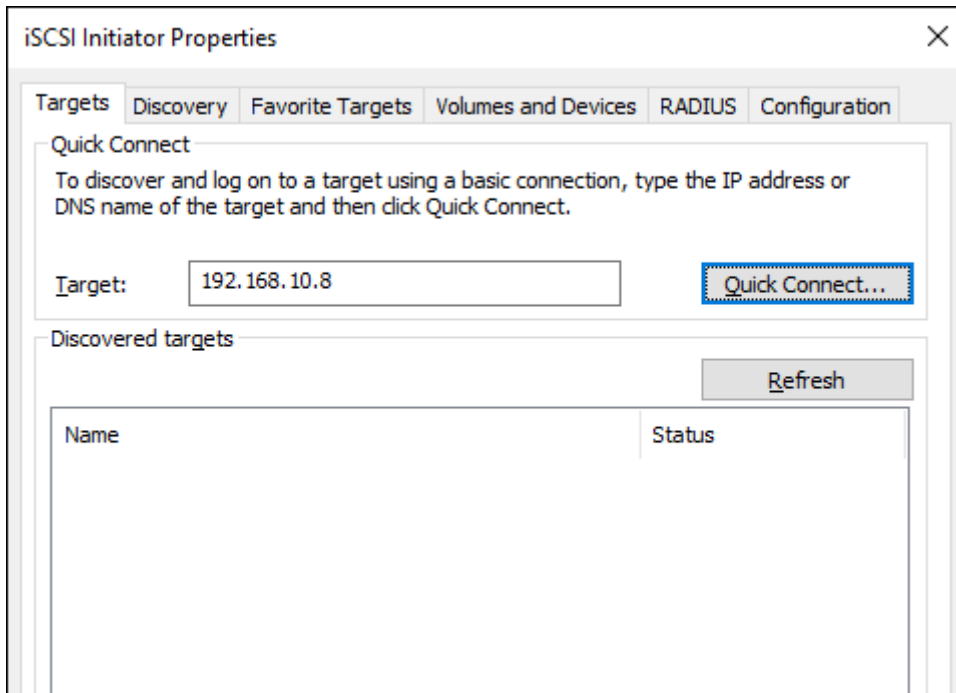

**3** Confirm if the connection is established and click *Done*.

Connecting a volume is finished.

## Formatting Volumes

If using the connected volume for the first time, the volume should be formatted to be used as a local drive. Follow the procedure below for formatting.

**1** In Windows, navigate to *Control Panel - Administrative Tools - Computer Management*.

**2** Click *Disk Management*.

When the "Initialize Disk" screen is displayed, click *OK* without changing any settings.

**3** Right-click the drive volume that shows the status "Unallocated" and click *New Simple Volume* from the displayed menu. Follow the screen to finish formatting.

Formatting a volume is finished. When the formatting process is completed, the drive will be visible as an icon in Computer or My Computer and can be used as a normal drive on the computer.

## Disconnecting a Volume

**1** In Windows, navigate to *Control Panel - Administrative Tools - iSCSI Initiator*.

The status of the connecting volume will be displayed as "Connected" under "Discovered targets".

**2** Select a volume to disconnect and click *Disconnect*.

**3** Click *Yes*.

**4** When the volume status is displayed as "Inactive", the disconnection was carried out properly.

## Using with Multiple Computers

---

If the TeraStation is divided into multiple volumes (or drives), it can be used with multiple computers. However, multiple computers cannot be accessed from one volume (or one drive) at the same time.

### Checking Whether iSCSI Volume is Connected

To check whether an iSCSI volume is connected, navigate to *Storage - iSCSI*. Current volumes will be listed. If "Connected" is displayed under "Connection", the volume is currently connected from the client.

## Configuring Access Restrictions

---

A CHAP name and secret can be configured for the entire iSCSI volume or each existing volume. Access restrictions can be configured so that entering a target CHAP name and secret is required for each connection.

The TeraStation can perform mutual authentication (two-way authentication). Dual passwords ensure that only authorized client computers can access the volume on the TeraStation.

Follow the procedure below to enable access restrictions.

### Configuring Access Restrictions for the Entire TeraStation

- 1 In Settings, click *Storage*.



- 2 Click  to the right of "iSCSI".



- 3 Click the *Security* tab.

4 Click *Edit* under "Access Control (Target Discovery)".

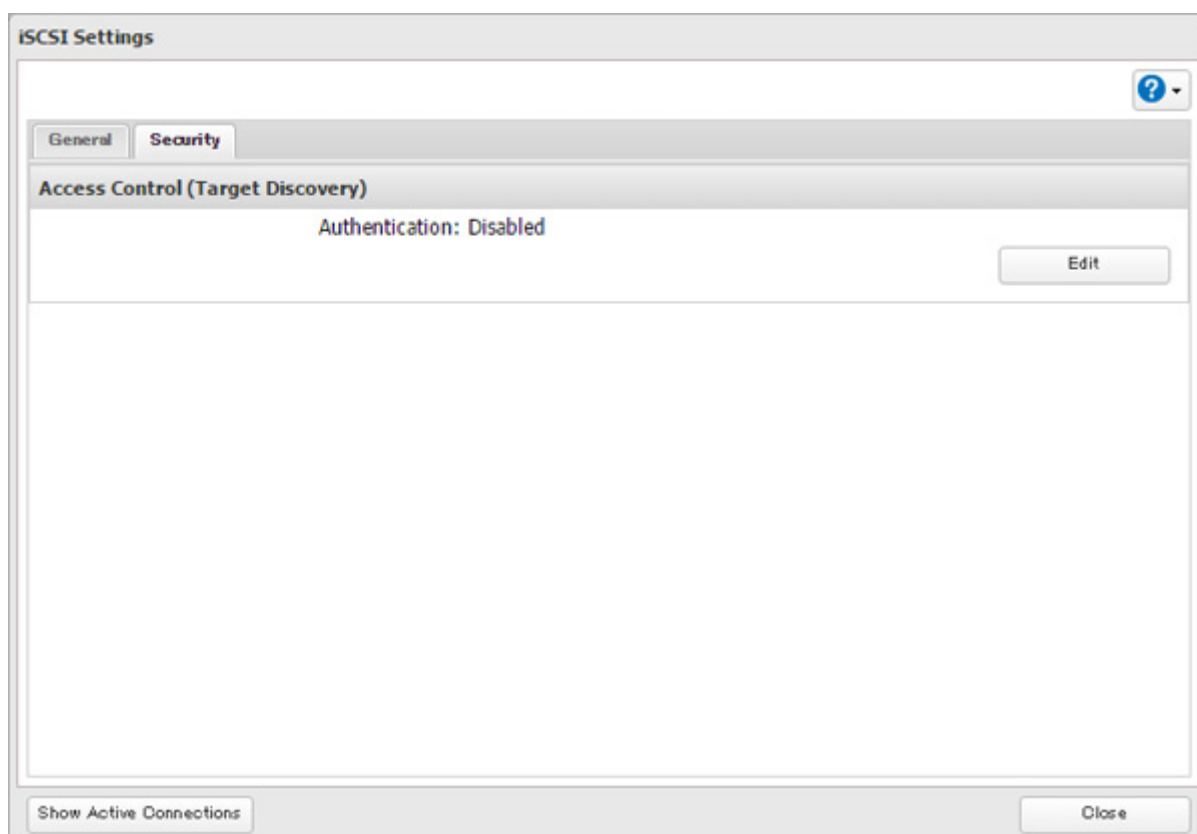

5 Enable authentication, enter the target CHAP name and secret, and click *OK*.

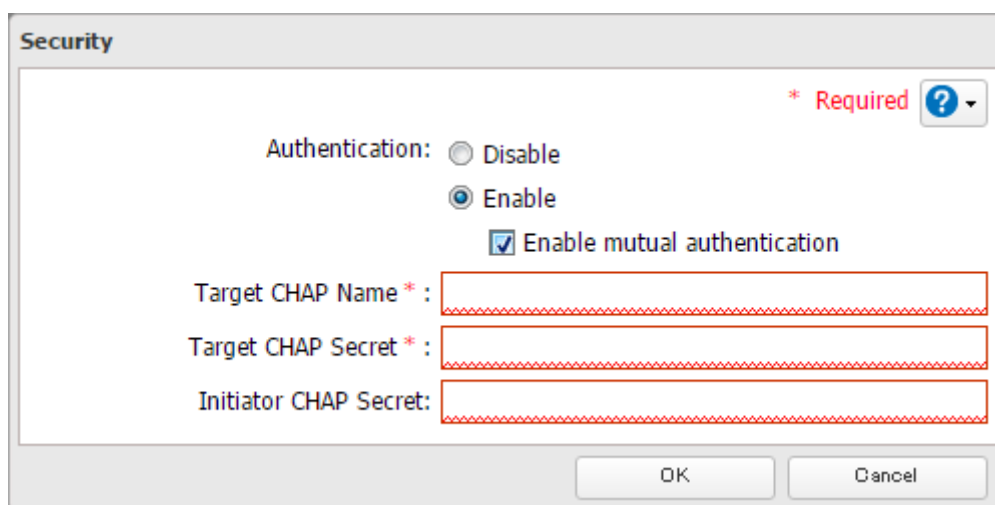

**Note:** To enable mutual authentication in addition to target CHAP name and secret authentication, select the "Enable mutual authentication" checkbox and enter the initiator CHAP secret.

To search or connect the volume which has mutual authentication enabled from Microsoft iSCSI Initiator, initiator CHAP secret settings should be configured.

6 Click *Close*.

Configuring access restrictions for the entire TeraStation is finished.

## Connecting Volumes on the Access-Restricted TeraStation

If access restrictions are configured for the entire iSCSI volume, that volume will not be detected by Microsoft iSCSI Initiator. To connect that volume, the target CHAP name and secret should be authenticated.

- 1** Open the Microsoft iSCSI Initiator.
- 2** Register the initiator CHAP secret to your computer first. If you didn't enable mutual authentication, skip this step.  
Click *CHAP* in the "Configuration" tab. In the "Initiator CHAP secret" box, enter the configured initiator CHAP secret and click *OK*.
- 3** In the "Discovery" tab, click *Discover Portal*.
- 4** Enter the TeraStation's IP address in the "IP address or DNS name" box.
- 5** Click *Advanced*.
- 6** Select the "Enable CHAP log on" checkbox and enter the target CHAP name into the "Name" box and the target CHAP secret into the "Target secret" box.  
If mutual authentication is enabled, select the "Perform mutual authentication" checkbox.
- 7** Click *OK* twice.
- 8** In the "Targets" tab, select the volume from "Discovered targets" and click *Connect - OK*.
- 9** If the status of the selected volume is displayed as "Connected" under "Discovered targets", the connection is established properly.

Accessing the volume on the access-restricted TeraStation is finished.

## Configuring Access Restrictions for Individual Volumes

If access restrictions are configured for a volume, that volume cannot be accessed unless the target CHAP name and secret are authenticated.

- 1** In Settings, click *Storage*.



- 2** Click  to the right of "iSCSI".



- 3** Click the volume to enable access restrictions.

- 4** Enable authentication, enter a target CHAP name and secret, and click *OK*.

The screenshot shows the 'Editing iSCSI Volume' dialog box. It has two main sections: 'General' and 'Authentication'. In the 'General' section, 'Backstore' is 'File I/O', 'Volume Connection' is 'Enable', 'Volume' is 'sample', 'Volume Description' is empty, 'Drive/Array' is 'Array 1 / 11079 GB', 'Size' is '50 GB + 0 GB = 50 GB / Remaining 11028 GB', and 'Target Name' is 'iqn.2004-08.jp.buffalo.7403bd101028.sample'. In the 'Authentication' section, 'Authentication' is 'Enable', 'Mutual Authentication' is checked, and 'Target CHAP Name', 'Target CHAP Secret', and 'Initiator CHAP Secret' are empty. A red asterisk and 'Required' label are in the top right corner. Buttons for 'Advanced Settings', 'OK', and 'Cancel' are at the bottom.

**Note:** To enable mutual authentication, select the "Enable" checkbox to the right of "Mutual Authentication" and enter the initiator CHAP secret.

- 5** The "Confirm Operation" screen will open. Enter the confirmation number, then click *OK*.

- 6** Click *OK*, then *Close*.

Configuring access restrictions for each iSCSI volume is finished.

## Connecting to Individual Volumes that are Access-Restricted

- 1** Open the Microsoft iSCSI Initiator.
- 2** Register the initiator CHAP secret to your computer first. If you didn't enable mutual authentication, skip this step.  
Click *CHAP* in the "Configuration" tab. In the "Initiator CHAP secret" box, enter the configured initiator CHAP secret and click *OK*.
- 3** In the "Discovery" tab, click *Discover Portal*.
- 4** Enter the TeraStation's IP address in the "IP address or DNS name" box.
- 5** Click *Advanced*.
- 6** Select the "Enable CHAP log on" checkbox and enter the target CHAP name into the "Name" box and the target CHAP secret into the "Target secret" box.  
If mutual authentication is enabled, select the "Perform mutual authentication" checkbox.
- 7** Click *OK* twice.

**8** In the "Targets" tab, select the volume from "Discovered targets" and click *Connect*.

**9** Click *Advanced*.

**10** Select the "Enable CHAP log on" checkbox and enter the target CHAP name into the "Name" box and the target CHAP secret into the "Target secret" box.

If mutual authentication is enabled, select the "Perform mutual authentication" checkbox.

**11** Click *OK* twice.

**12** If the status of the selected volume is displayed as "Connected" under "Discovered targets", the connection is established properly.

Accessing the access-restricted volume is finished.

## Expanding Volume Sizes

---

The volume size of the existing volumes can be expanded after they are created.

### Notes:

- Expanding the volume size may erase all data in the volume depending on the formatting type. Back up the data before expanding the volume size is recommended.
- To expand the volume size, the volume should be have "File I/O" selected for the "Backstore" option, or was created in a drive or array with LVM enabled.

**1** In Settings, click *Storage*.



**2** Click  to the right of "iSCSI".

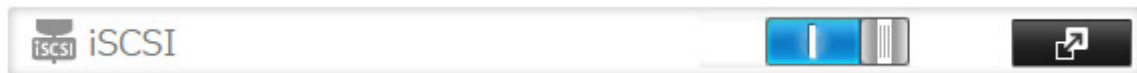

**3** Select the volume to expand.

**4** Enter the desired volume size to add and click *OK*.

**Editing iSCSI Volume**

\* Required ?

**General**

Backstore: File I/O

Volume Connection:  Enable  Disable

Volume: sample

Volume Description:

Drive/Array: Array 1 / 11079 GB

Size: 50 GB +  GB = 50 GB / Remaining 11028 GB

Target Name: iqn.2004-08.jp.buffalo.7403bd101028.sample

Authentication:  Enable

Target CHAP Name \* :

Target CHAP Secret \* :

Mutual Authentication:  Enable

Initiator CHAP Secret:

Disable

Advanced Settings OK Cancel

**5** The "Confirm Operation" screen will open. Enter the confirmation number, then click *OK*.

**6** Click *OK*, then *Close*.

Expanding the volume size is finished.

## Deleting Volumes

To delete an existing volume, follow the procedure below.

**Note:** Deleting a volume will erase all data on the volume. Back up the data before deleting the volume.

**1** In Settings, click *Storage*.



**2** Click  to the right of "iSCSI".



**3** Select the volume to delete and click *Delete Volume*.

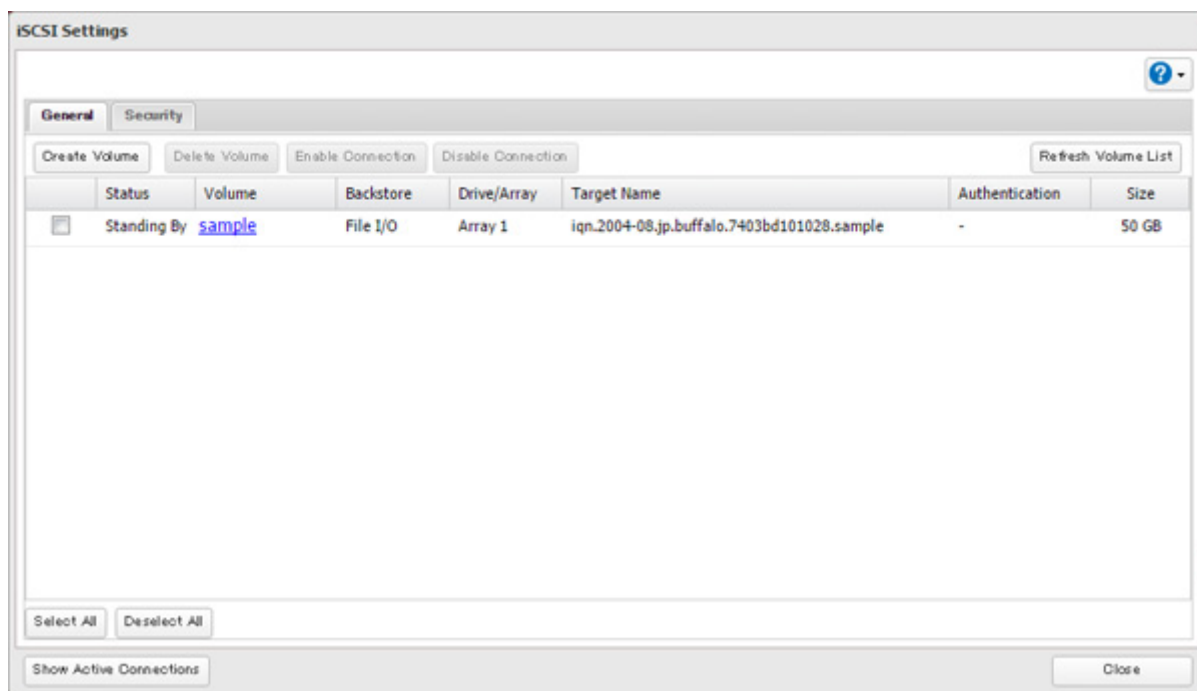

**4** Confirm that the volume is correctly selected on the screen and click *OK*.

**5** The "Confirm Operation" screen will open. Enter the confirmation number, then click *OK*.

**6** Click *OK*.

**7** Click *Close*.

Deleting the volume is finished.

# Chapter 5 Backup

## Back Up from the TeraStation

You can back up TeraStation folders to:

- A different folder on the TeraStation
- Another LinkStation on the network
- Another TeraStation on the network

You can also configure backup jobs from Easy Admin.

**Note:** For best results, using LAN port 3 to connect a backup device is recommended.

## Preparing a Backup Destination

First, configure a folder as a backup destination.

**1** In Settings, click *File Sharing*.

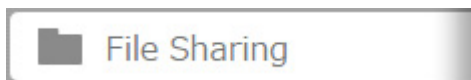

**2** Click  to the right of "Folder Setup".

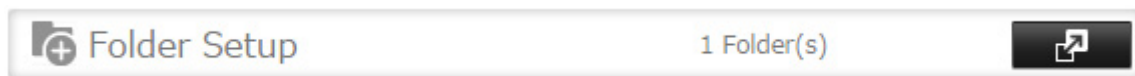

**3** Choose the folder to set as a backup destination.

**4** Click *Edit*.

**5** Under "LAN Protocol Support", select the "Backup" checkbox and click *OK*.

**Note:** If a backup access password is configured for the shared folder, that folder will not show up as a target for the backup source or destination when configuring a backup job on another LinkStation or TeraStation. To configure a backup access password, enter it into the "Backup Access Password" box. Leave this box blank if you don't want a backup access password.

## Backing Up to a LinkStation or TeraStation on Another Network When Connected via VPN

You can back up to a LinkStation or TeraStation on another network as long as the two networks are connected by a VPN. Follow this procedure to enter the IP address or hostname of the destination LinkStation or TeraStation.

If your setup meets the requirements below, you don't have to configure these settings:

- The source and destination TeraStations are on the same network.
- No backup access password is set for the destination TeraStation.
- No TeraStation from outside the subnet or connected by a VPN is used.

1 In Settings, click *Backup*.



2 Click  to the right of "Backup".

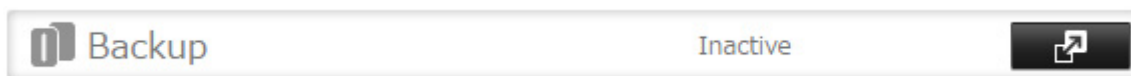

3 Click *List of LinkStations and TeraStations*.

The screenshot shows a window titled "Backup List". At the top right, there is a help icon (a question mark in a blue circle) with a dropdown arrow. Below this, the text "Backup Access Password:" is followed by a "Set" button. Underneath, there is a text input field containing "List of LinkStations and TeraStations". To the left of this field are two buttons: "Create New Job" and "Delete Job(s)". To the right of the input field is a "Filter:" label followed by a text input field and a close button (an 'X' in a square). The main area of the window is a table with the following headers: "Job", "Scheduled", "Day", "Time", "Operation Mode", and "Status". The table body is currently empty. At the bottom left of the window, there are two buttons: "Select All" and "Deselect All". At the bottom right, there is a "Close" button.

- 4 Click *Add* under "Off-Subnet Devices", enter the IP address or hostname of the destination LinkStation or TeraStation, and click *Close*.

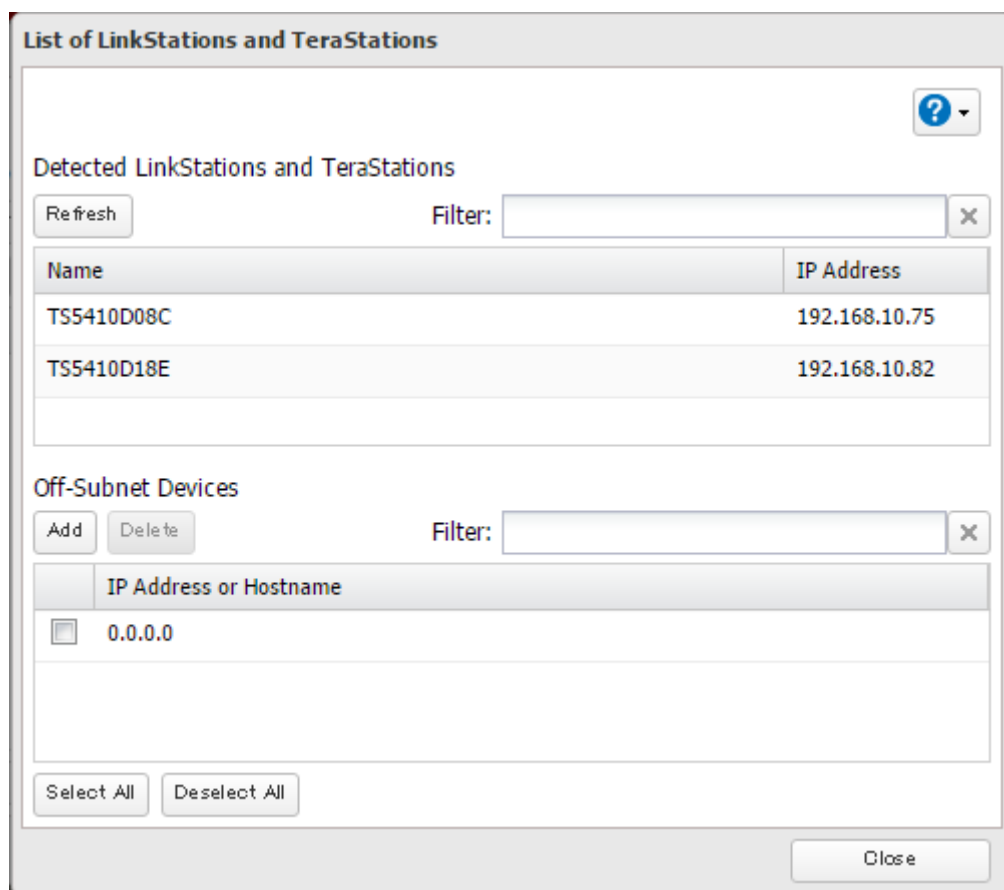

**Notes:**

- To back up data between LinkStations or TeraStations on a network using jumbo frames, make sure that both devices are configured to use identical (or similar) MTU sizes. If MTU sizes are significantly different, the backup job may not be properly performed. In such a case, select the default MTU size (1500 bytes).
- You can also specify a hostname by a fully qualified domain name (FQDN).
- Windows-based TeraStations with multibyte characters in the hostname may not be detected as a backup destination, and folders in these devices cannot be used as backup destination folders.

## Configuring a Backup Job

- 1 In Settings, click *Backup*.



- 2 Click  to the right of "Backup".



**3** Click *Create New Job*.

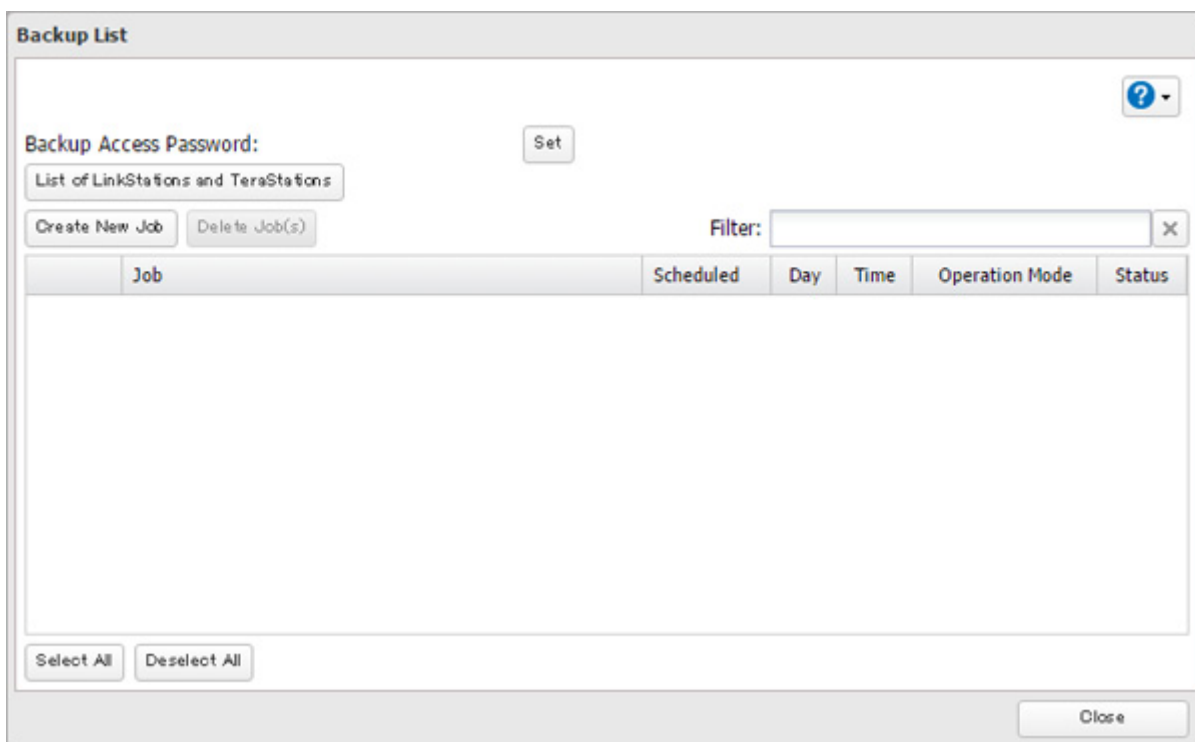

**Note:** Up to 8 backup jobs can be configured.

**4** Select backup settings such as date and time to run.

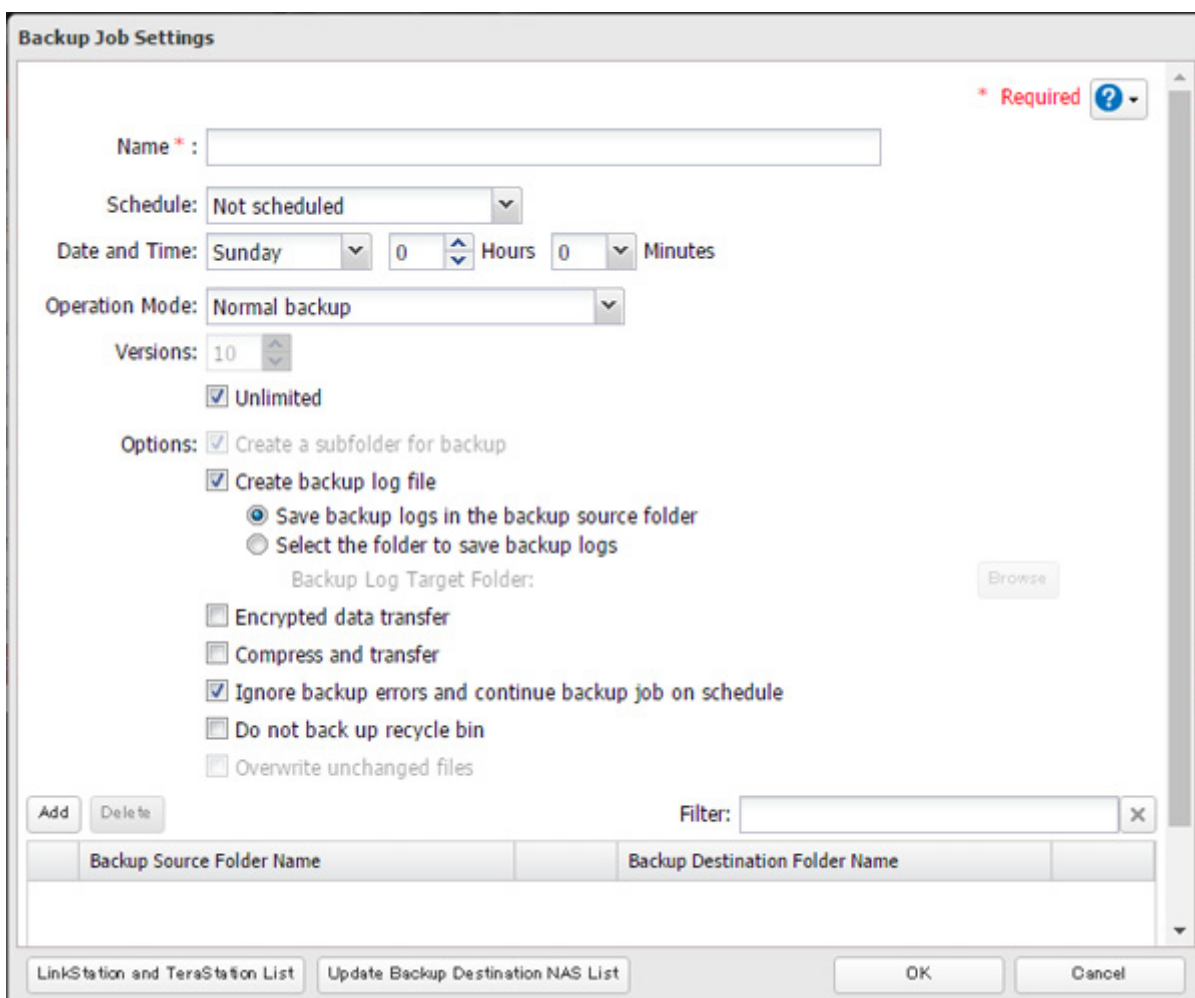

The following types of backup jobs may be selected:

Type	Files included
Normal backup	All files in the source will be backed up to the destination. You can specify how many backup versions to keep from 1–400, or select "Unlimited" to keep all backups until the drive is full. If a specific number of backup versions is specified, the backup destination folder should be on the same TeraStation that the backup job is configured from, or on an external USB drive attached to that TeraStation.
Overwrite (incremental)	The first time the backup job runs like a normal backup. In subsequent backups, files added to the source as well as files deleted from the source are kept in the backup folder.
Overwrite (differential)	The first backup job runs like a normal backup. As each additional backup job runs, files are added to and deleted from the backup folder. The backup destination folder is always the same size as the backup source folder.
Management backup	Each time a backup is executed, management information is stored, and only files that have changed are copied or deleted. Data is retrieved from the previous backup file for files that were not changed. This is useful for making backups with limited space or for referencing status at a particular point in time (for use for data snapshot applications). The destination folder for a management backup should be a local folder on this TeraStation or on a USB drive attached to it. The destination folder will be set to read-only. Do not use folders from drives formatted with FAT. You can specify how many backup versions to keep from 1–400, or select "Unlimited" to keep all backups until the drive is full. The backup destination folder should be on the same TeraStation that the backup job is configured from, or on an external USB drive attached to that TeraStation.

**5** Click *Add*.

**6** Click *Browse* under "Backup Source Folder Name".

**7** Select the shared folder that will be the backup source, then click *OK*.

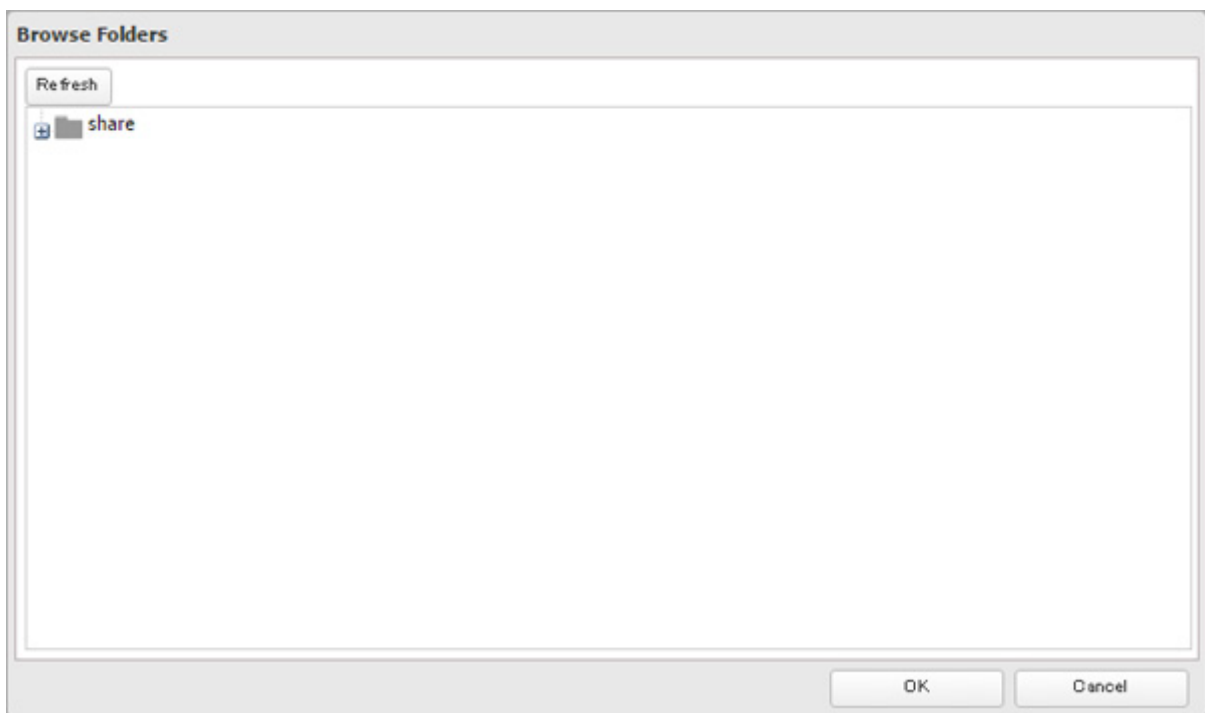

**8** Click *Browse* under "Backup Destination Folder Name".

**9** Select the backup destination and click *OK*.

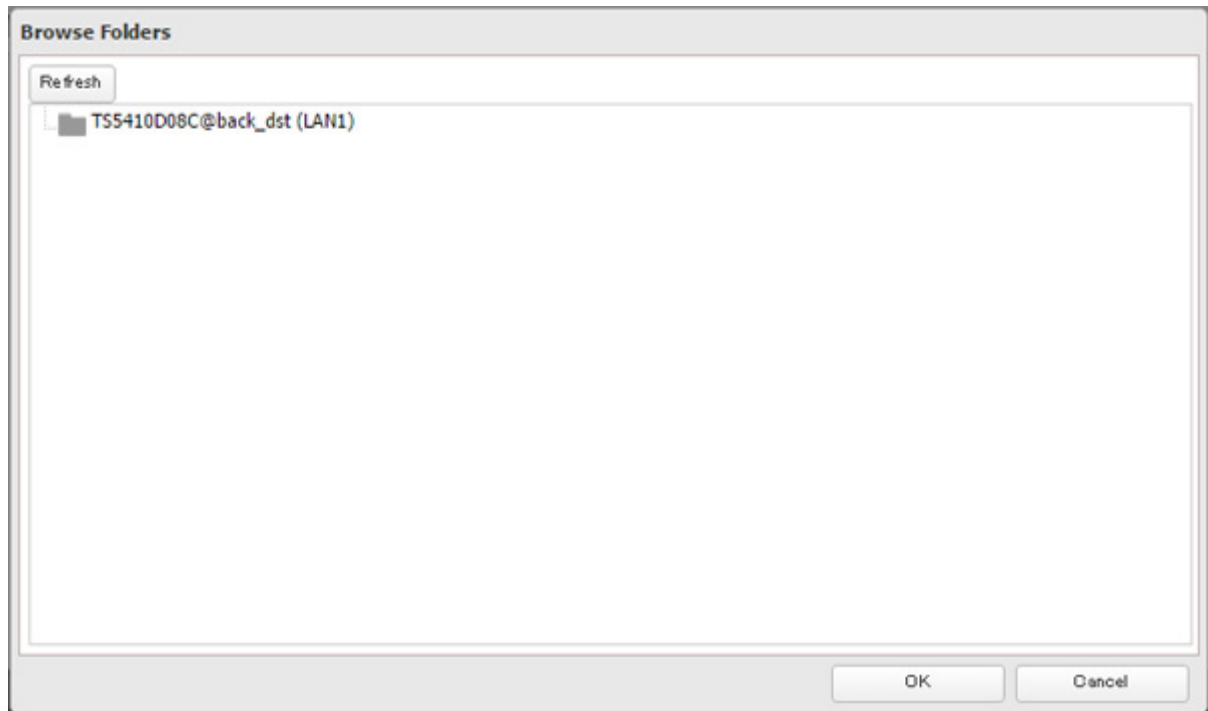

**10** Click *OK*. Jobs added to "Backup List" are displayed.

**11** Click *Close*.

## Backup Logs

The following backup error codes may be recorded in the backup log. Read the description and try the respective corrective actions for the error.

Code	Description	Corrective Action	Log Example
Code 3	The backup destination USB drive could not be found.	Verify that the backup destination USB drive is connected to the TeraStation properly.	rsync error: errors selecting input/output files, dirs (code 3) at main.c(634) [Receiver=3.1.0] Can't write to backup destination(target disk is broken?).
Code 5	The backup destination shared folder could not be found.	Verify that the Ethernet cable is surely connected and that the hub or other devices on the network are turned on.	rsync error: error starting client-server protocol (code 5) at main.c(1504)
Code 10	The Ethernet cable was disconnected from the backup source TeraStation when the backup job started.	Reconnect the Ethernet cable.	rsync error: error in socket IO (code 10) at clientserver.c(128) [sender=3.1.0pre1]
Code 11	The drive capacity of the backup destination TeraStation became full.	Delete unnecessary files and folders.	rsync error: error in file IO (code 11) at receiver.c(389) [receiver=3.1.0]

Code	Description	Corrective Action	Log Example
Code 12	Could not communicate between backup source and destination TeraStations.	Verify that the Ethernet cable is surely connected and that the hub or other devices on the network are turned on.	rsync error: error in rsync protocol data stream (code 12) at io.c(515)
	The settings of the TeraStation were changed while the backup job was running.	Do not change the settings while the backup job is running. If changed, the connection is temporarily terminated and the backup job will fail.	
Code 14 Code 22	Insufficient memory on the TeraStation was not enough so that the backup job did not run.	Reduce the number of backup destination files or disable any other functions running at the same time.	ERROR: out of memory in flist_expand rsync error: error allocating core memory buffers (code 22) at util.c(120) [sender=2.6.8] rsync: fork failed in do_recv: Cannot allocate memory (12) rsync error: error in IPC code (code 14) at main.c(655) [receiver=2.6.8]
Code 20	The connection was disconnected while the backup job was running.	Do not change the settings while the backup job is running. If changed, the connection is temporarily terminated and the backup job will fail.	rsync error: received SIGINT, SIGTERM, or SIGHUP (code 20) at rsync.c(242)
Code 23	Invalid characters were used in the filename or folder name of the backup destinations.	Change the filename or folder name using compatible characters. Available characters are described in the "Adding a Shared Folder" section in chapter 3.	rsync error: some files could not be transferred (code 23) at main.c(702)
	The backup destination files were updated while the backup job was running.	Do not overwrite the backup destination files while the backup job is running. If updated, the backup destination files will not be backed up and the backup job will fail.	
Code 23	4 GB or more files were backed up to the FAT32-formatted USB drive.	Reduce the file size to 4 GB or less or change the file system to one other than FAT32. Refer to the "Adding an External Drive" section in chapter 4 for the compatible file systems.	rsync error: some files could not be transferred (code 23) at main.c(702)
	The TeraStation backed up the data to the FAT32-formatted USB drive, then the upper- or lowercases of filename and folder name on the backup source TeraStation were changed.	Do not change the upper- or lowercase of filenames and folder names on the backup source TeraStation if the backup destination USB drive is formatted to FAT32. Linux on the TeraStation is case-sensitive but FAT isn't, so the same filename and folder name that only differs in upper- or lowercase will not be identified and treated as the same file or folder. To back up properly, using XFS or ext3 is recommended.	

Code	Description	Corrective Action	Log Example
Code 24	The backup destination files were updated while the backup job was running.	Do not overwrite the backup destination files while the backup job is running. If updated, the backup destination files will not be backed up and the backup job will fail.	rsync warning: some files vanished before they could be transferred (code 24) at main.c
Code 30	The Ethernet cable was disconnected from the backup source or destination TeraStations while the backup job was running.	Reconnect the Ethernet cable.	rsync error: timeout in data send/receive (code 30) at io.c(195) [sender=3.1.0]
B14	Insufficient TeraStation memory.	Restart the TeraStation and try again.	-
B101	The backup destination TeraStation does not exist.	Verify that the backup destination TeraStation is turned on, the Ethernet cables are connected properly, and the hostname of the backup destination TeraStation is not changed.	-
B102		Verify that the backup destination folders on the backup destination TeraStation exist in the shared folder list and the backup destination folders are configured for backup from Settings.	-
B103	The backup source folders on the backup source TeraStation do not exist.	Verify that the backup source folders on the backup source TeraStation exist in the shared folder list.	-
B104	The backup destination folders on the backup destination TeraStation do not exist.	Verify that the backup destination folders on the backup destination TeraStation exist in the shared folder list.	-
B105	The drives were not recognized.	Verify that the drives are recognized properly from Settings. If you configure the "usbdisk" folders for the backup source or destinations, confirm if these folders exist in the shared folder list.	-
B106	The file systems of the USB drive are not supported.	Verify that the USB drive are formatted to the compatible file systems. If you configure the management backup in the backup job, FAT format cannot be used for the backup destination.	-
B107	The device files such as "/dev/null" etc. does not exist.	Restart the TeraStation and try again.	-

---

## Replication

---

Replication copies all data from a share to a share on a different TeraStation. This is an easy way to configure a reliable system to provide data protection in the event your main TeraStation fails. To configure replication, connect an Ethernet cable to the LAN port of each TeraStation and follow the procedure below.

**Notes:**

- For best results, use static IP addresses and LAN port 3 for connecting both replication TeraStations (source and destination).
- Replication source data is copied to the replication destination folder with a differential overwrite. Any data that is not in the replication source will be overwritten.

## Preparing a Replication Destination

---

First, configure a folder as a replication destination.

- 1** In Settings, click *File Sharing*.

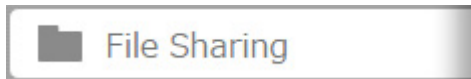

- 2** Click  to the right of "Folder Setup".



- 3** Choose the folder to set as a replication destination.

- 4** Click *Edit*.

- 5** Under "LAN Protocol Support", select the "Backup" checkbox and click *OK*.

**Note:** Do not configure a backup access password for the shared folders. Folders with a backup access password set cannot be selected as replication destinations.

## Configuring a Replication Task

---

- 1** In Settings, click *Backup*.

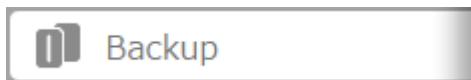

- 2** Click  to the right of "Replication".



**3** Click *Edit*.

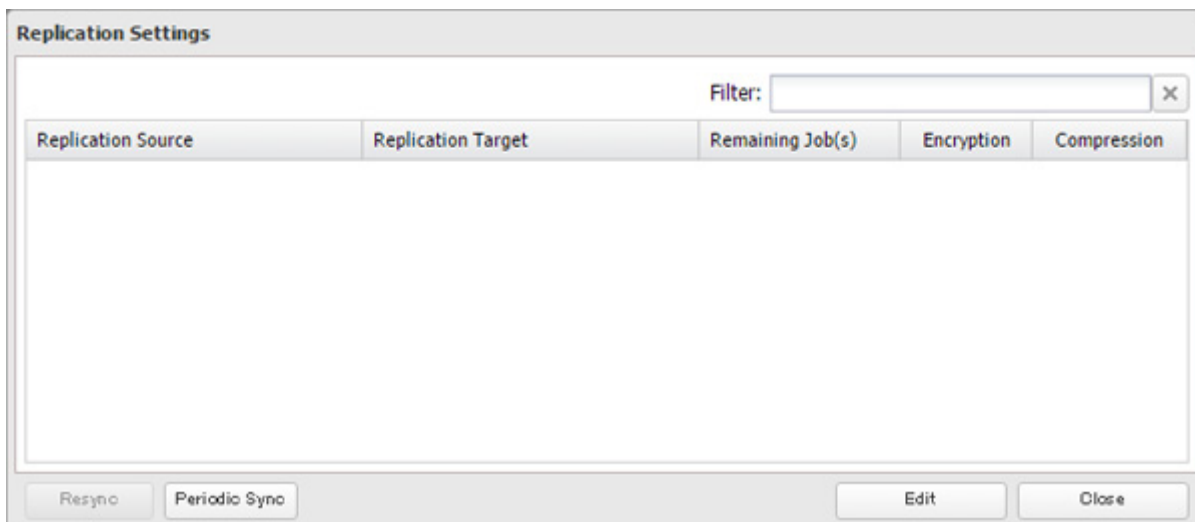

**4** Click *Add*.

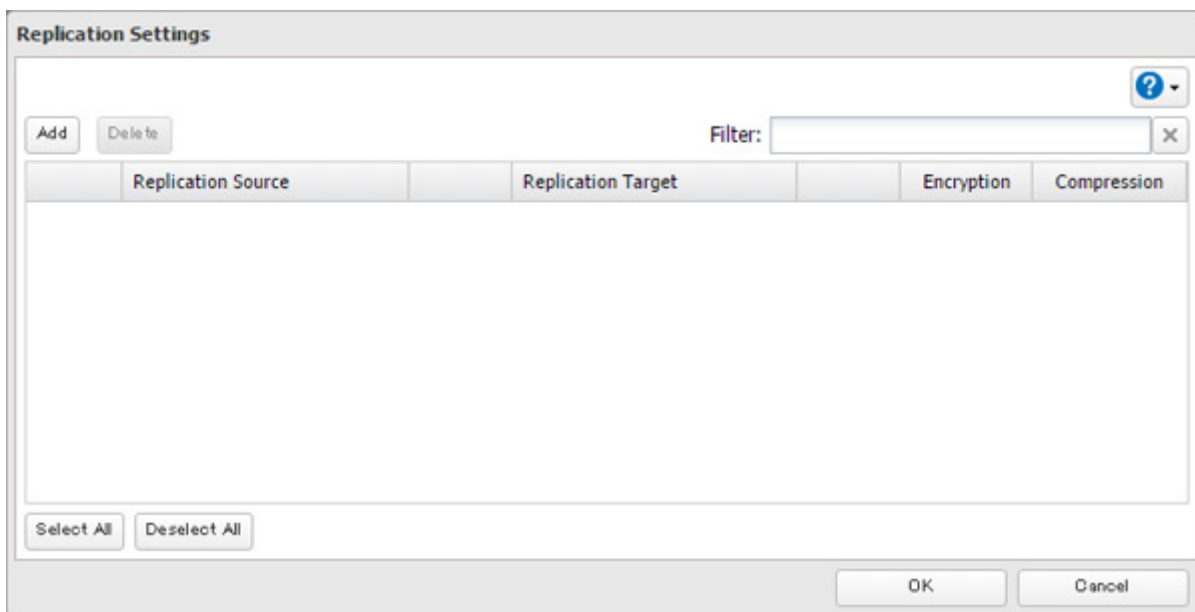

**5** Click *Browse* under "Replication Source".

**6** Select the shared folder that will be the replication source, then click *OK*.

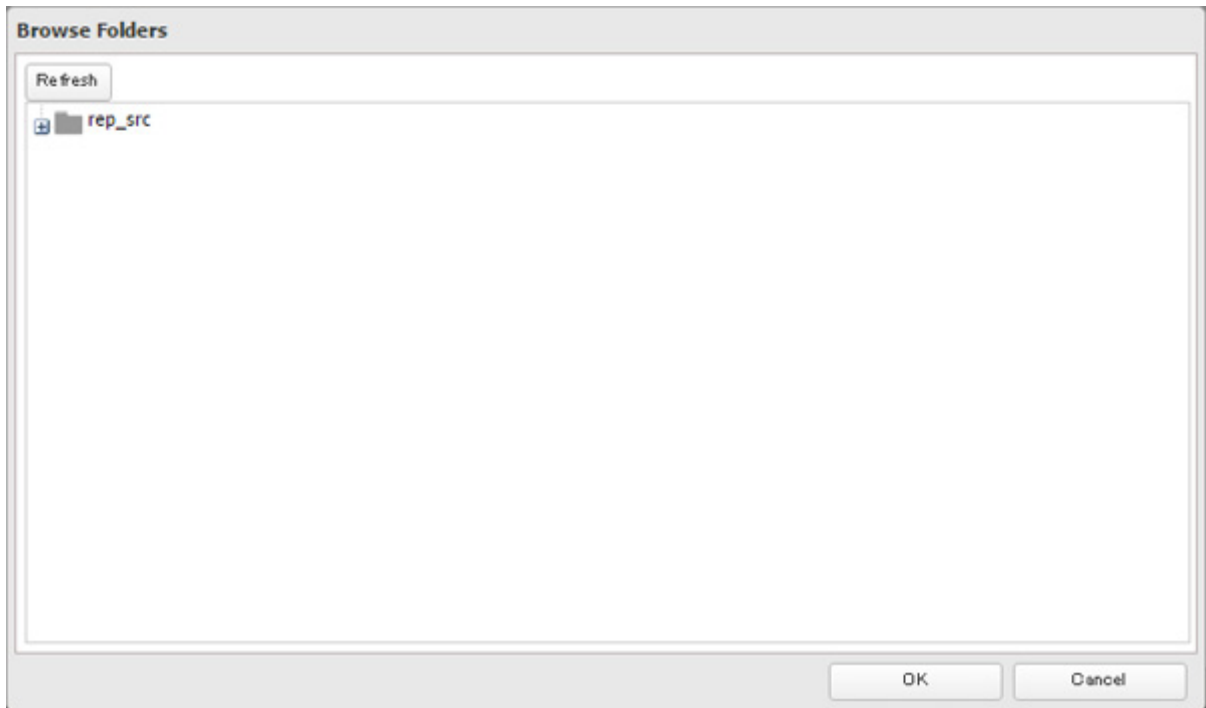

**7** Click *Browse* under "Replication Target".

**8** Select the shared folder that will be the replication destination, then click *OK*.

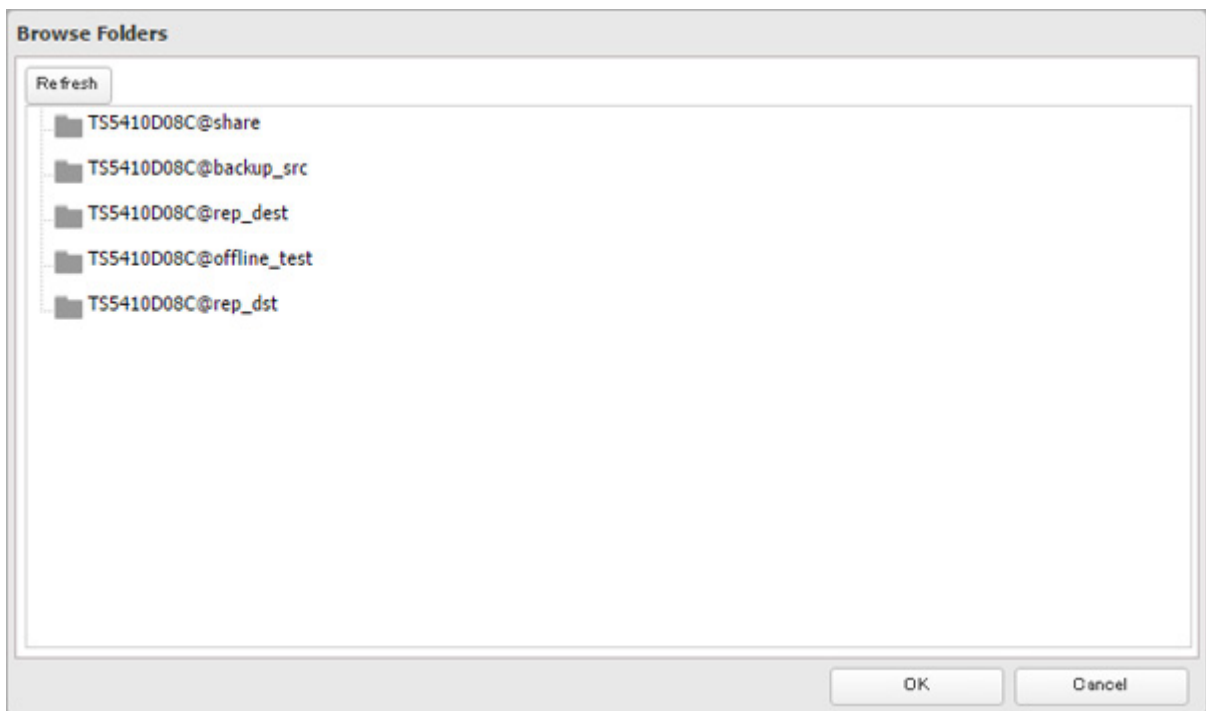

**9** Click *OK*.

**10** Click *Yes*.

**Notes:**

- During setup, you may choose to encrypt and/or compress replication data. Encrypted data will be transferred securely on the network. Compressed data will ease network loading and is recommended for slow or heavily

loaded network connections. Either will increase the CPU load on the source TeraStation. Encrypted and compressed data will be decrypted and decompressed on the destination TeraStation.

- A maximum of 64 shared folders can be configured for replication.
- Replication can also be used to copy all data from a share to a share on an attached external drive. Format the drive with ext3 or XFS before using it for replication. Drives with FAT32 partitions are not supported with replication.
- You can select the first and second level of shared folders and USB drives connected to the TeraStation as the replication source. Folders whose names contain more than 80 alphanumeric characters or "@" cannot be selected.  
As the replication destination, you can select the first level of shared folders, USB drives, and on/off-subnet NASs shared folders.
- Don't use the same TeraStation for both failover and replication, or replication and Time Machine.
- Don't configure replication from one source folder to multiple destination folders.
- If a network problem causes a replication error, unsynced data may be shown as "0" even though replication is incomplete. Click *Resync* to recover from the replication error. All files from the source folder will be copied to the destination folder.

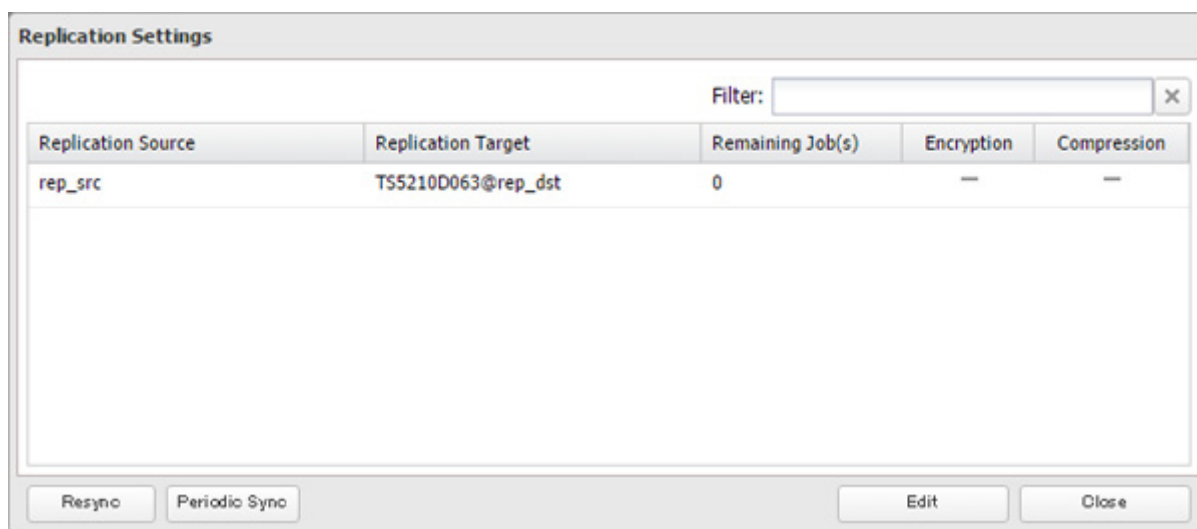

## Synchronizing Between Source and Destination Units Periodically

To copy files that are saved via other file sharing protocols such as AFP or FTP to the replication destination regularly, configure "Periodic Sync" from Settings. Follow the procedure below.

- 1 In Settings, click *Backup*.



- 2 Click  to the right of "Replication".



### 3 Click *Periodic Sync*.

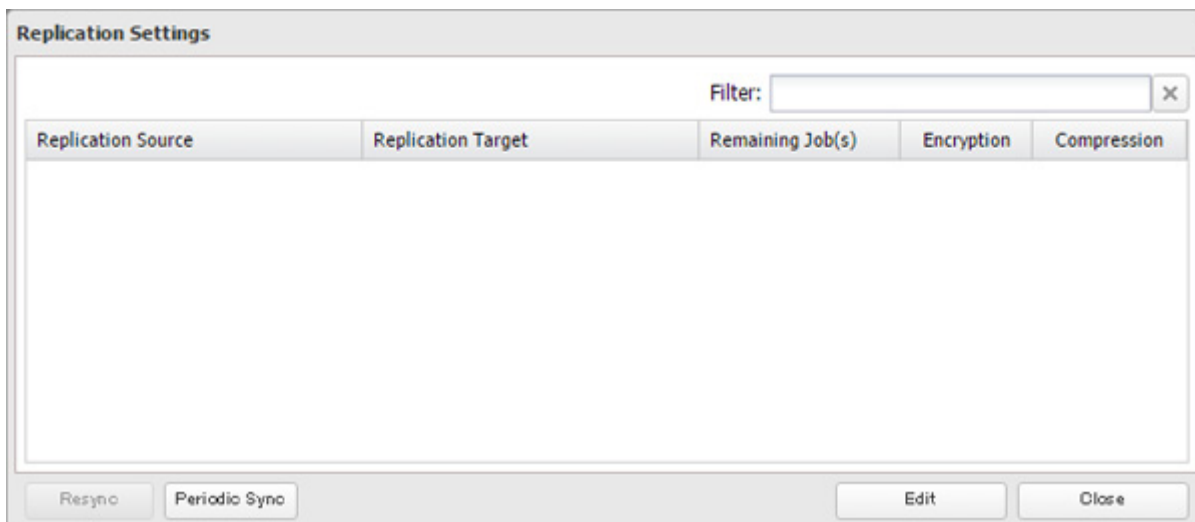

### 4 Select "Daily" or "Weekly" from the "Schedule" drop-down list. If "Daily" is selected, configure the sync period. If "Weekly" is selected, specify the week days and the sync period.

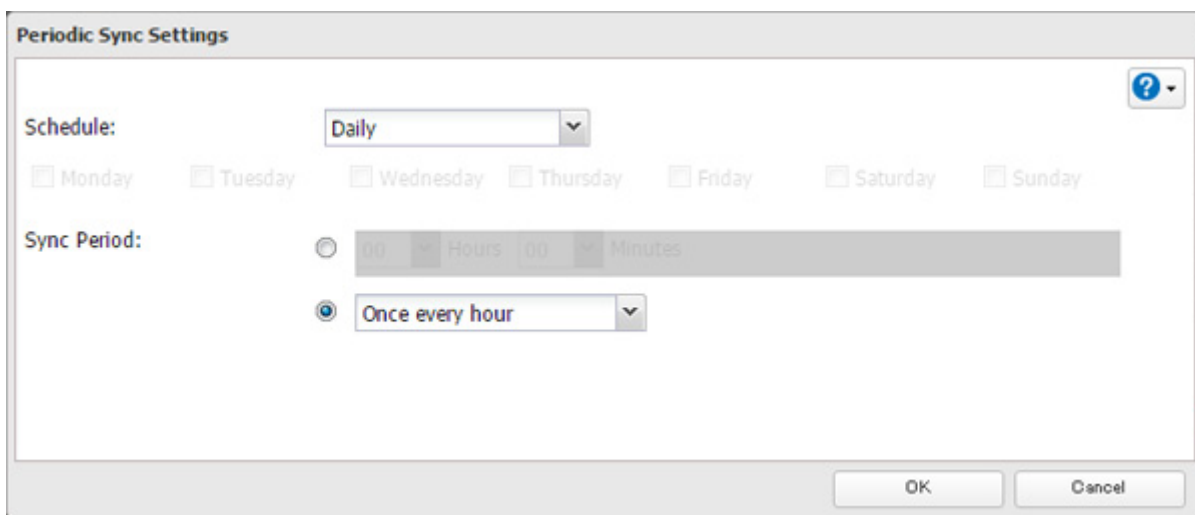

### 5 When the configuration is finished, click *OK*.

---

## Failover

---

With failover, two TeraStations are connected to the network for redundancy. If an issue renders the main TeraStation inaccessible, operation automatically switches to the backup TeraStation.

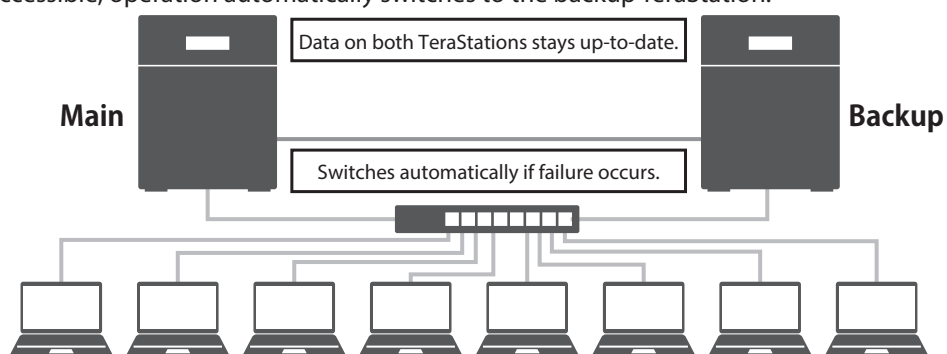

Failover will activate during any of the following situations:

- **The backup TeraStation cannot detect the main TeraStation within a specified time**

If the backup TeraStation has not received a packet from the main TeraStation within a specified time, the backup TeraStation considers the main TeraStation to have failed. By default, it will try 5 times and wait 60 seconds. If this is triggered by accident, reconfigure failover from the main TeraStation.

- **Errors**

Failover will occur if any of the following errors occur:

E12 (cooling failure), E14 (cannot mount RAID array), E16 (drive not found), E22 (cannot mount drive), E30 (drive failure)

**Notes:**

- Only use identical model and capacity TeraStations for failover. If the capacity of the main TeraStation is larger than that of the backup TeraStation, an I33 replication error will occur.
- All drive bays of a TeraStation should be occupied if it will be used for failover. Failover will not work if a drive is missing from any bay.

## Usage Restrictions

---

### Functional Restrictions

Failover is not available when any of the following functions are enabled:

Replication, sleep mode, encrypted drive volume, LVM volume, iSCSI volume, port trunking, cloud storage, Dropbox Sync, hot spare, access restrictions by Active Directory domain

### Setting Restrictions

The following functions will not be available while failover is enabled:

Initializing settings, changing the RAID settings, formatting drives, iSCSI volume, changing the backup unit's settings, turning the TeraStation on and off, updating the firmware.

While failover is enabled, shutdown, power-on, and firmware update operations can be made available by temporarily changing the TeraStation to maintenance mode. Maintenance mode can be enabled or disabled at *Backup - Failover* in the main TeraStation's Settings. Click *Maintenance mode* to enable maintenance mode, or click *Cancel maintenance mode* to disable maintenance mode.

To update the firmware while in maintenance mode, the main TeraStation can be updated from Settings, but the backup TeraStation cannot. Download the firmware updater from the Buffalo website for the backup TeraStation and try updating the firmware through it.

### Non-Transferable Settings

The settings below are not copied from the main TeraStation to the backup TeraStation. Make a note of the original settings so that they can be configured manually if failover errors.

WebAccess\*, UPS synchronization, the backup job settings either if specifying shared folders on the backup TeraStation or USB drives as the backup destination, and USB drives' shared folder settings

\* After failover, re-register your BuffaloNAS.com account for WebAccess on the new main TeraStation if LAN port 1 is assigned a new static IP address or using DHCP. If the new main TeraStation inherits the original static IP address for LAN port 1, WebAccess settings will be transferred and you will not need to reconfigure it.

### Using with UPS

Once failover is configured, you cannot set up a UPS for the backup TeraStation. Configure your UPS before configuring failover. UPS recovery can be configured for both the main and backup TeraStations. However, the UPS settings of the main TeraStation will not be copied to the backup TeraStation.

If the backup TeraStation is configured to sync with the UPS connected to the main TeraStation, and the main TeraStation becomes unavailable, the backup TeraStation will not be able to detect a power outage. In this case, move the UPS cable from the main TeraStation to the backup TeraStation and reconfigure the UPS link settings.

## Configuring Failover

---

Use the same LAN ports for transferring data and it is recommended that both TeraStations are configured with static IP addresses for the purposes of failover. It is also recommended to use LAN port 3 for failover. This section explains using an example with LAN ports 1 and 3.

### Using the Same LAN Port for Both Failover and Connecting to the Network

Using this setup, if the main TeraStation fails, the backup TeraStation will replace it completely. The backup TeraStation will be updated over normal network traffic.

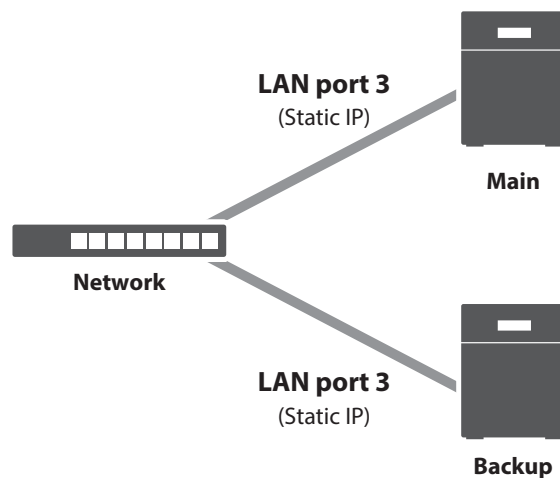

### Using Different LAN Ports for Connecting to the Network and Failover

With this setup, the backup TeraStation and main TeraStation are connected by a second Ethernet cable connecting their LAN 3 ports. Updating is done over this dedicated network path, so updates are quicker and don't interfere with normal network traffic.

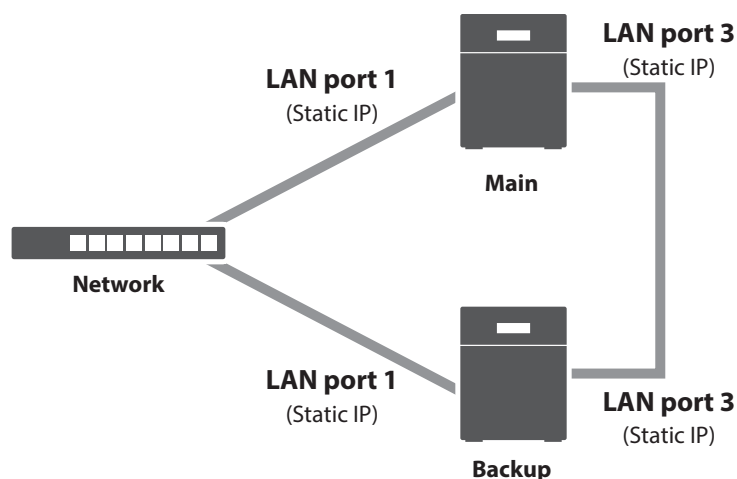

- **LAN Port 1 for Alive Check and LAN Port 3 for Failover**  
Select the IP address labeled "(LAN1)" for the LAN port setting of "IP Settings for File Sharing" and select "(LAN3)" for "Backup LAN Port" in Settings.
- **LAN Port 3 for Both Alive Check and Failover**  
Select the IP address labeled "(LAN3)" for the LAN port settings both "IP Settings for File Sharing" and "Backup LAN Port" in Settings.

## Configuration

- 1 In Settings for the main TeraStation, click *Backup*.

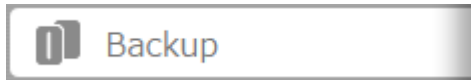

- 2 Click  to the right of "Failover".



- 3 Click *Configure Failover*.

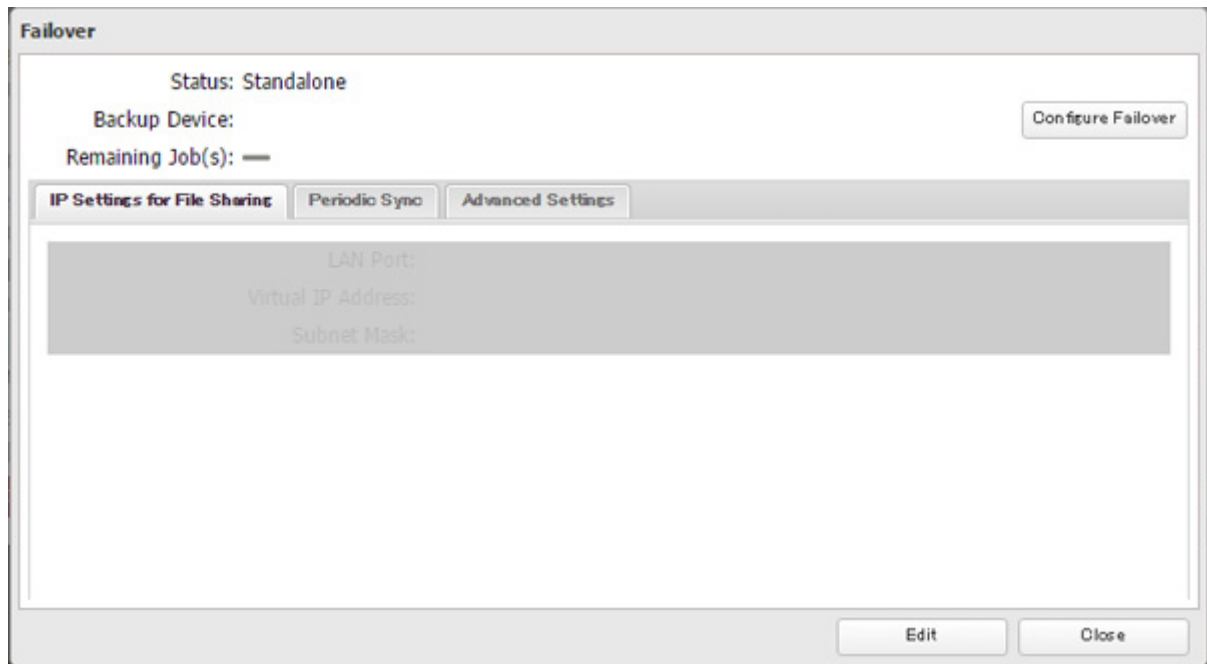

- 4 Select a TeraStation to be the backup destination device and enter its administrator username and password (the username is "admin", the password is "password" by default).

**Failover Settings**

\* Required ?

**Backup Device Settings:**

Backup Device: TS5410D18E

Administrator Username \* :

Administrator Password \* :

**IP Settings for File Sharing:**

LAN Port: (LAN1) 192.168.10.82

Virtual IP Address \* :

Subnet Mask \* : 255.255.255.0

**Backup LAN Port:**

(LAN1) 192.168.10.82

Use TeraStations of the same model and storage capacity for the main and backup units. Set the Ethernet frame size to 1500 bytes for both units.

Continue Close

- 5 Select the LAN port to be used for sharing files and enter a virtual IP address and subnet mask.

**About Virtual IP Address:**

A virtual IP address is an IP address that will be used for file sharing while failover is configured. By assigning a different IP address from the one to be assigned to the LAN port, you can access the TeraStation for sharing files, as well as open Settings using the virtual IP address. This IP address will be inherited to the backup TeraStation when failover occurs, so you can access the backup TeraStation even if you don't know the backup TeraStation's static IP address.

Configure an unused IP address for the virtual IP; make sure it uses the same segment as the main and backup TeraStations.

- 6 Select the LAN port to be used for transferring data via failover, then click *Continue*.

- 7 If the administrator username and password is correct, the backup TeraStation will beep. Press and hold the function button to accept the settings from the main TeraStation. When you press the function button, the backup TeraStation will stop beeping. Hold it down until the backup TeraStation beeps again.

- 8 The I51 message will display on the LCD panel and NAS Navigator2 for both TeraStations. Wait until initialization finishes. Failover is configured after it finishes and the I51 message disappears.

**Notes:**

- If replication is configured for more than one folder, initialize the TeraStation before configuring failover.
- The main TeraStation cannot be used as the backup location for Time Machine.
- Do not use the same TeraStation for both failover and replication, or failover and Time Machine.
- If email notification is enabled and failover occurs, navigate to *Management - Email Notification - Edit* in the main TeraStation's Settings and click *OK*.
- Ethernet frame size settings for main and backup TeraStations should be 1500 bytes. To change the Ethernet frame size, navigate to *Network - IP Address - Edit*, and change the Ethernet frame size to "1500" bytes.
- Files whose filenames contain more than 80 alphanumeric characters will not be backed up.
- If the I33 error message appears on the LCD panel, navigate to *Backup - Replication* and click *Resync*.

- If failover occurs unexpectedly due to issues such as network problems, even if neither TeraStation has failed, log in to both the main and backup TeraStations' Settings interface, reset the failover settings, and configure it again.
- The RAID array on the backup TeraStation may be reconfigured and resynchronized as part of the failover configuration process. This is expected behavior and not an error.

## Switching to the Backup Unit Manually

If "Switch to backup unit manually" is selected in the *Advanced Settings* tab on Settings, the backup TeraStation will not replace the main TeraStation if the main TeraStation fails. To have the backup TeraStation replace the main TeraStation, you can either:

- Log in to Settings for the backup TeraStation and click *Set as Main Unit*.
- Or, press and hold down the function button on the backup TeraStation.

## Synchronizing Between Main and Backup Units Periodically

To copy files that are saved via other file sharing protocols such as AFP or FTP to the backup TeraStation regularly, configure "Periodic Sync" from Settings. Follow the procedure below.

- 1 In Settings for the main TeraStation, click *Backup*.



- 2 Click  to the right of "Failover".

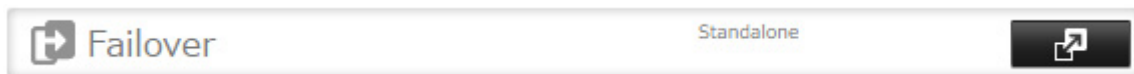

- 3 Click the *Periodic Sync* tab.

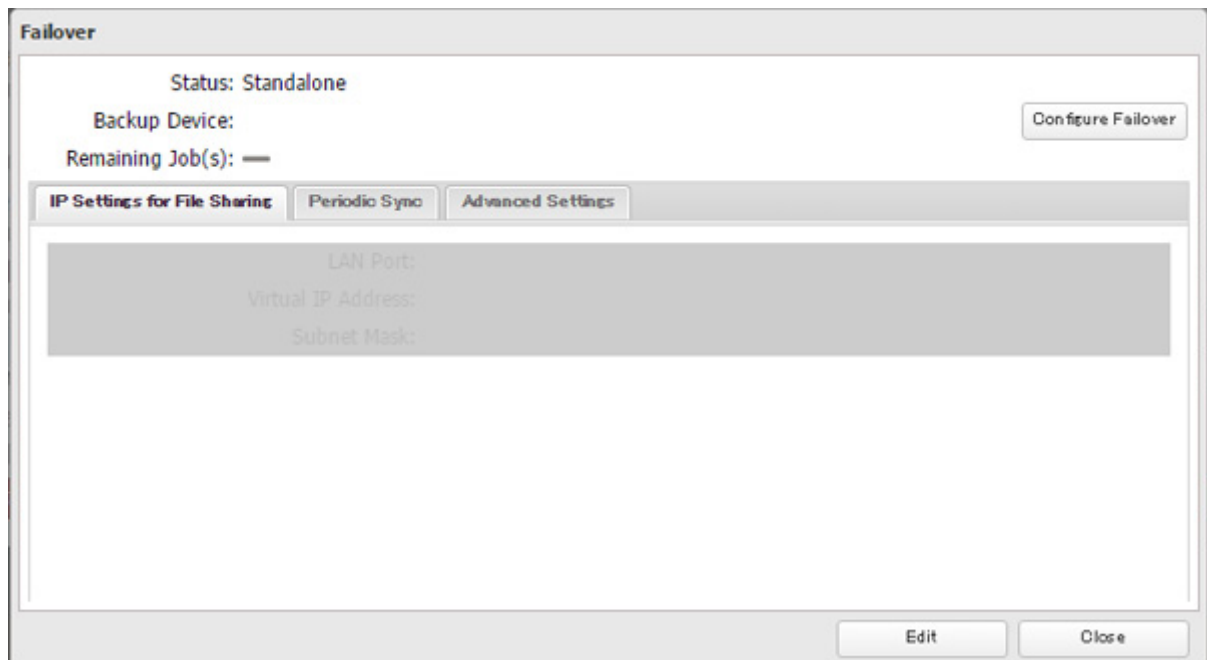

**4** Click *Edit*.

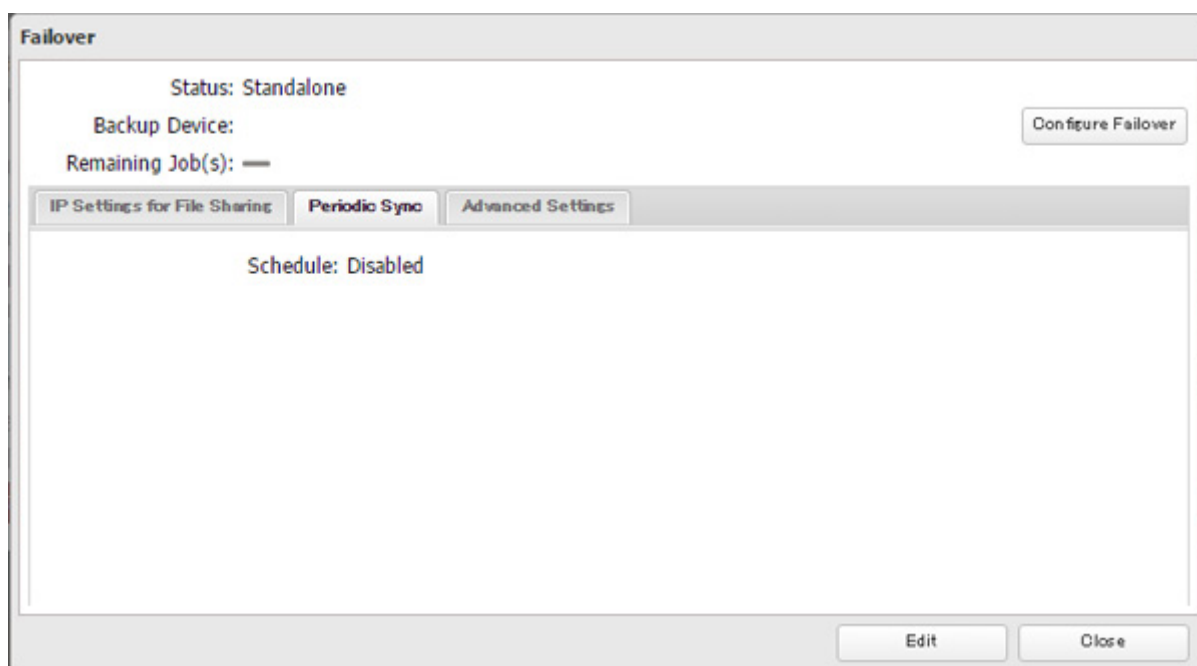

**5** Select "Daily" or "Weekly" from the "Schedule" drop-down list. If "Daily" is selected, configure the sync period. If "Weekly" is selected, specify the week days and the sync period.

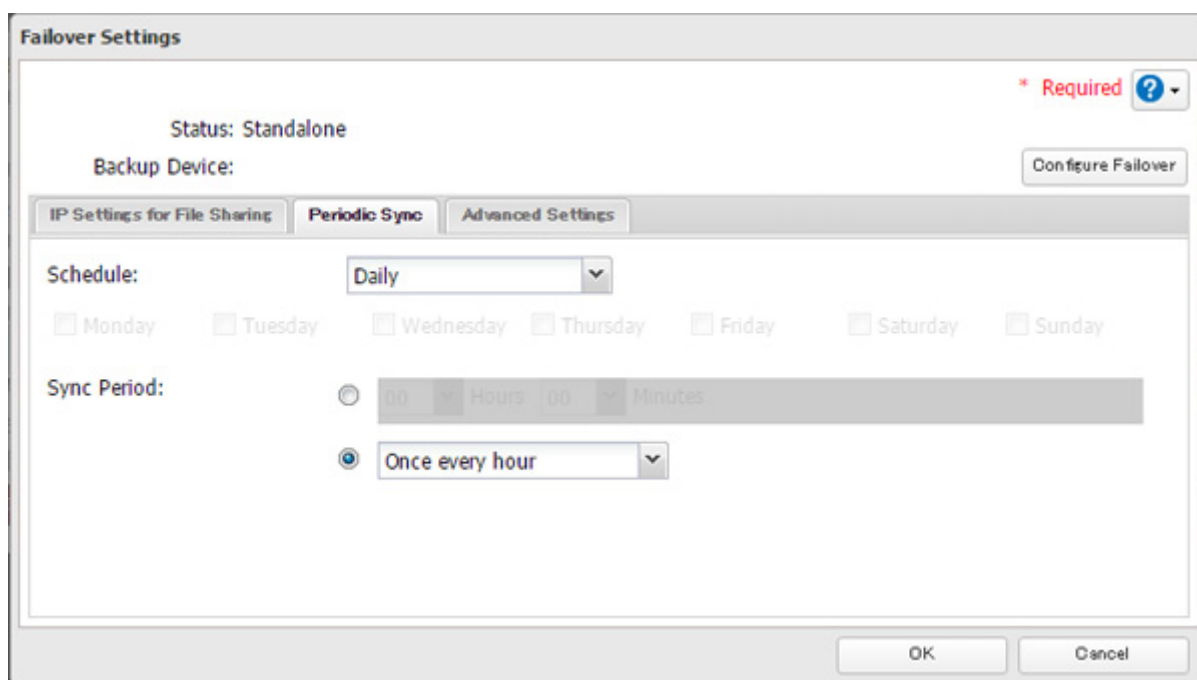

**6** When the configuration is finished, click *OK*.

---

## Backing Up Your Mac with Time Machine

---

Time Machine is a backup program included with macOS. Configure your TeraStation as shown to use Time Machine.

**1** In Settings, click *File Sharing*.

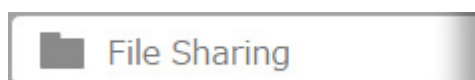

**2** Move the AFP switch to the  position to enable AFP.



**3** Click  to the right of "Folder Setup".



**4** Choose a shared folder as your backup destination for Time Machine.

**5** Click *Edit*.

**6** Under "LAN Protocol Support", select the "AFP (Mac)" checkbox and click *OK*.

**7** Click *OK*.

**8** Click *Close*.

**9** Click *Backup*.



**10** Click  to the right of "Time Machine".



**11** Click *Edit*.

**12** Click *Browse*.

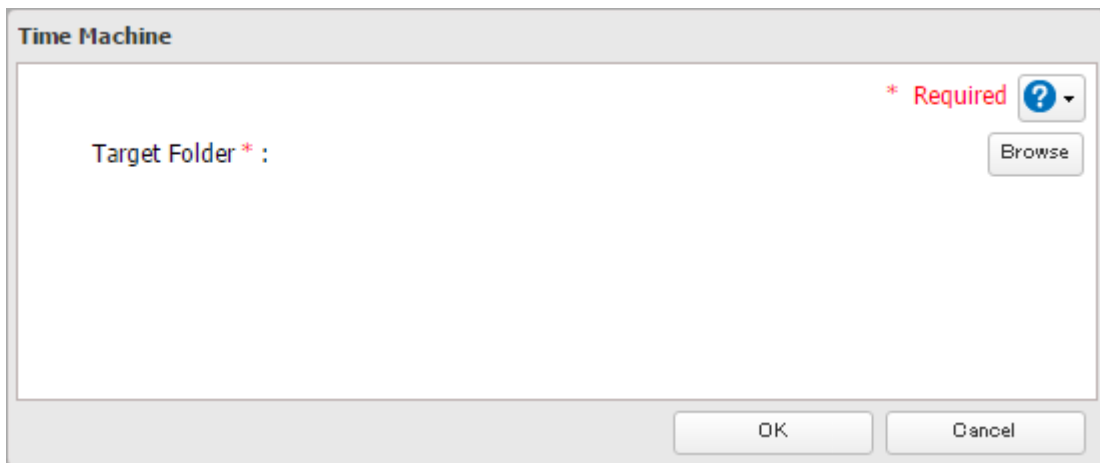

**13** Select the shared folder that you set in the previous step, then click *OK*.

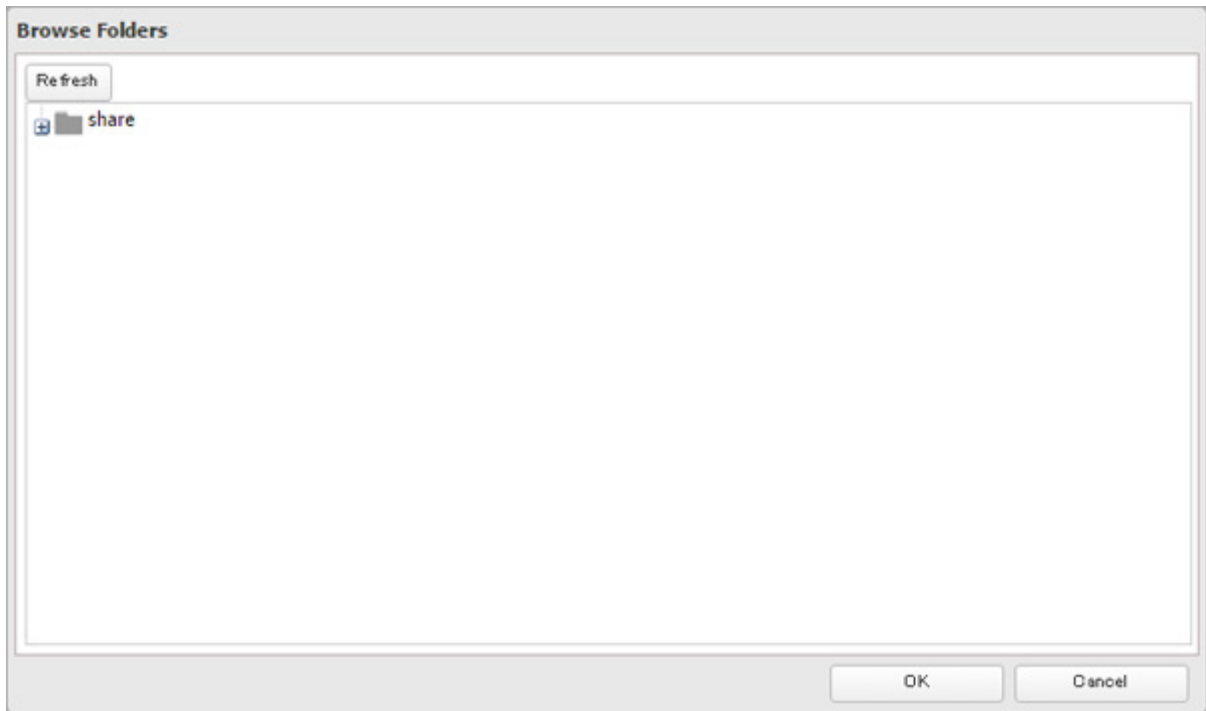

**14** Click *OK*.

**15** Click *OK*.

**16** Move the Time Machine switch to the  position to enable Time Machine.

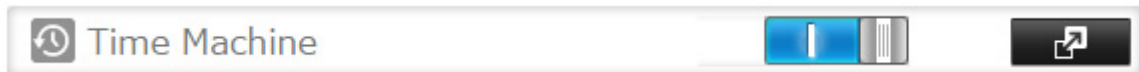

**17** On the Mac, open *System Preferences*.

**18** Click *Time Machine*.

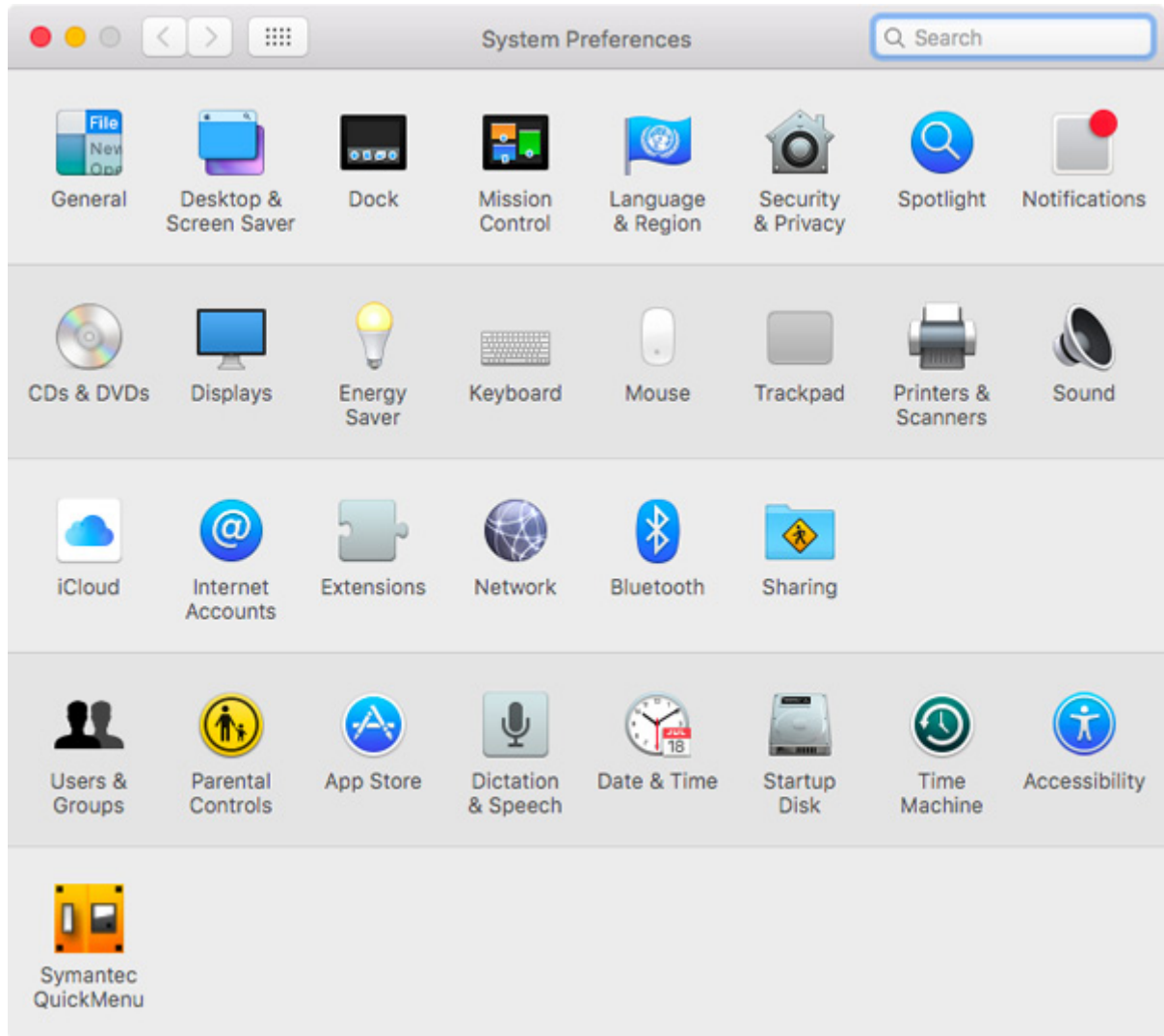

**19** Click *Select Backup Disk*.

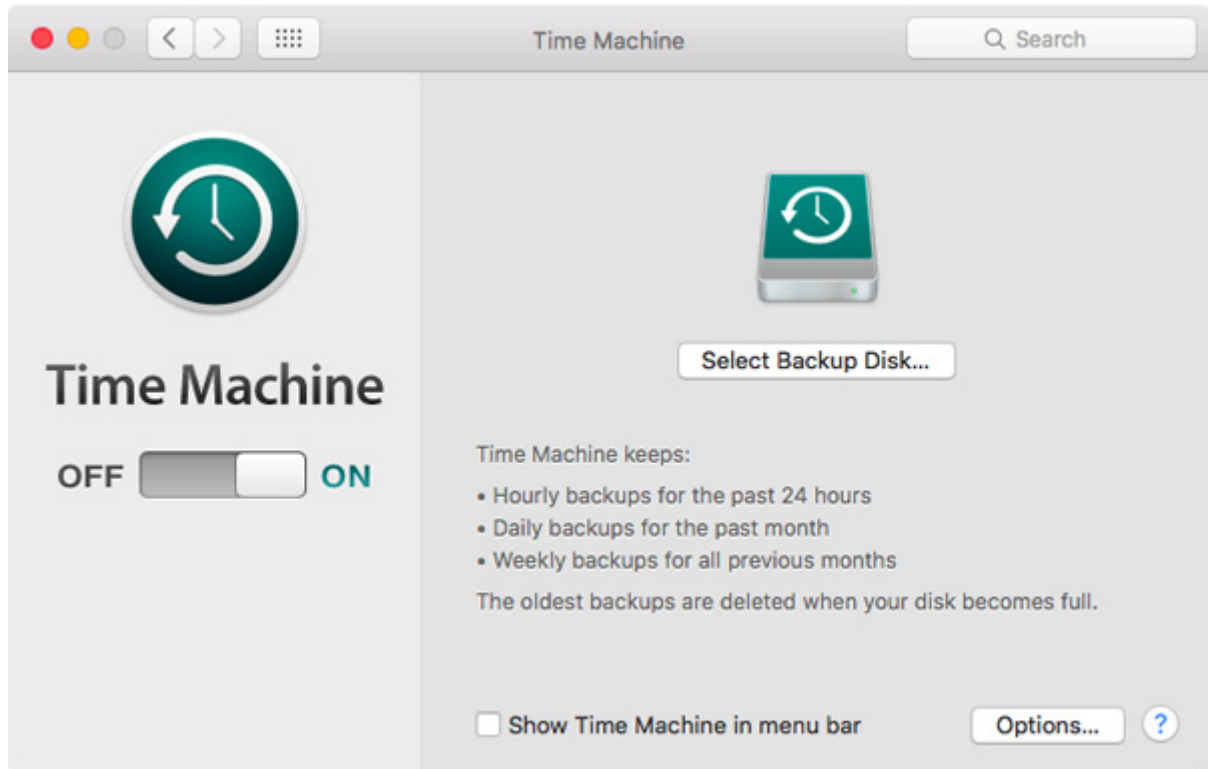

**20** Select the TeraStation, then click *Use Disk*.

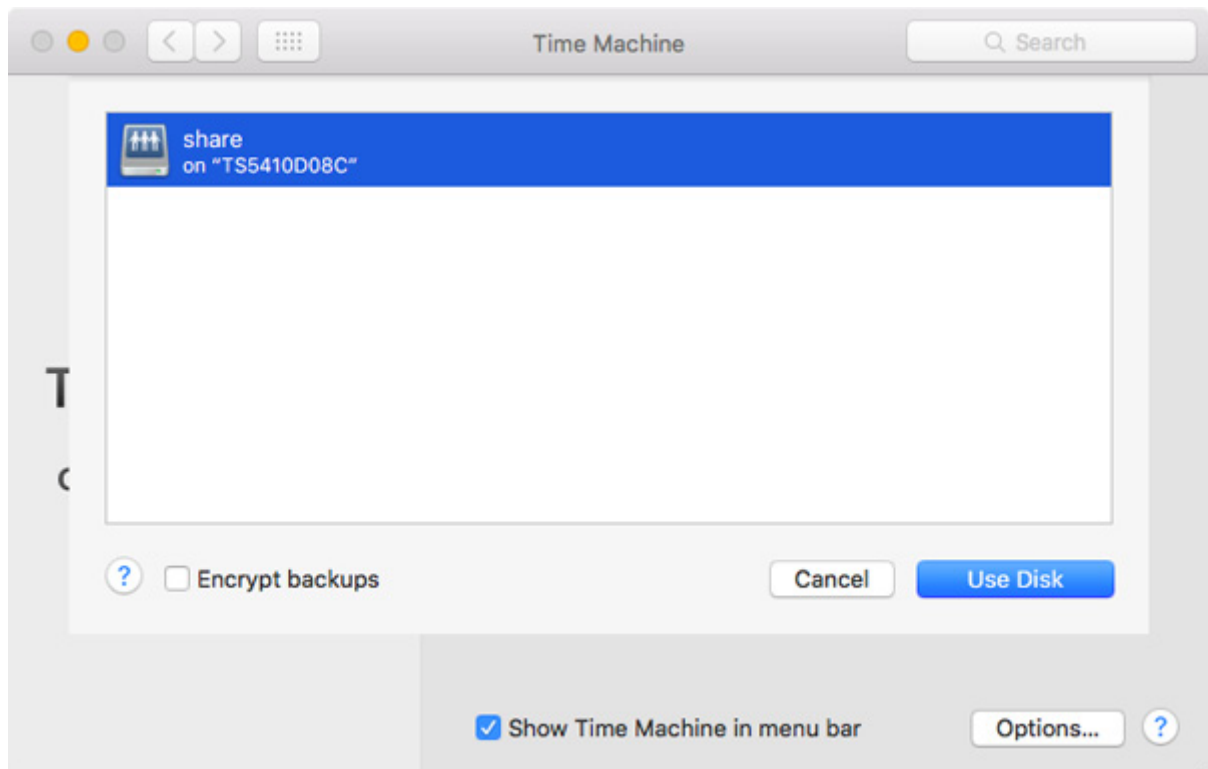

**21** Enter a username and password with the rights to access the shared folder of the TeraStation, then click *Connect*.

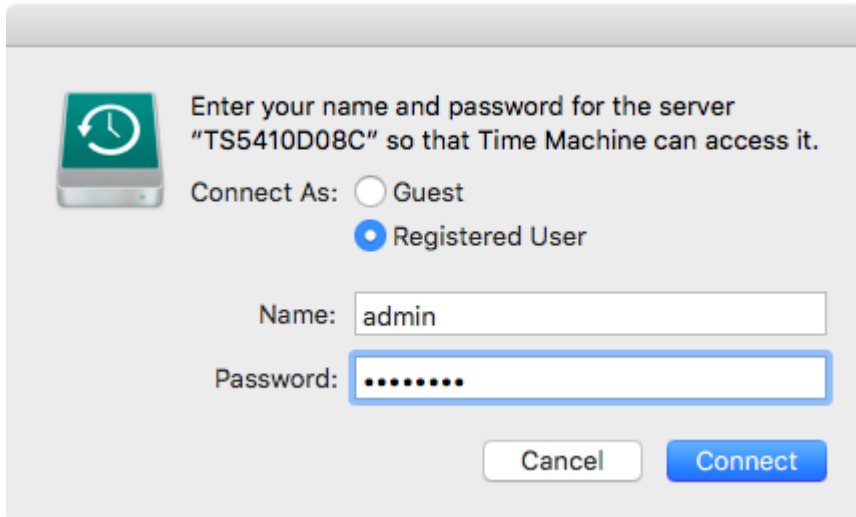

**Note:** If access restrictions are not configured on the destination share, log in with the administrator account. The default username and password for the administrator account are "admin" and "password". If access restrictions are configured, log in with an account with write privileges.

**22** Time Machine will count down from 120 seconds, and the backup will begin.

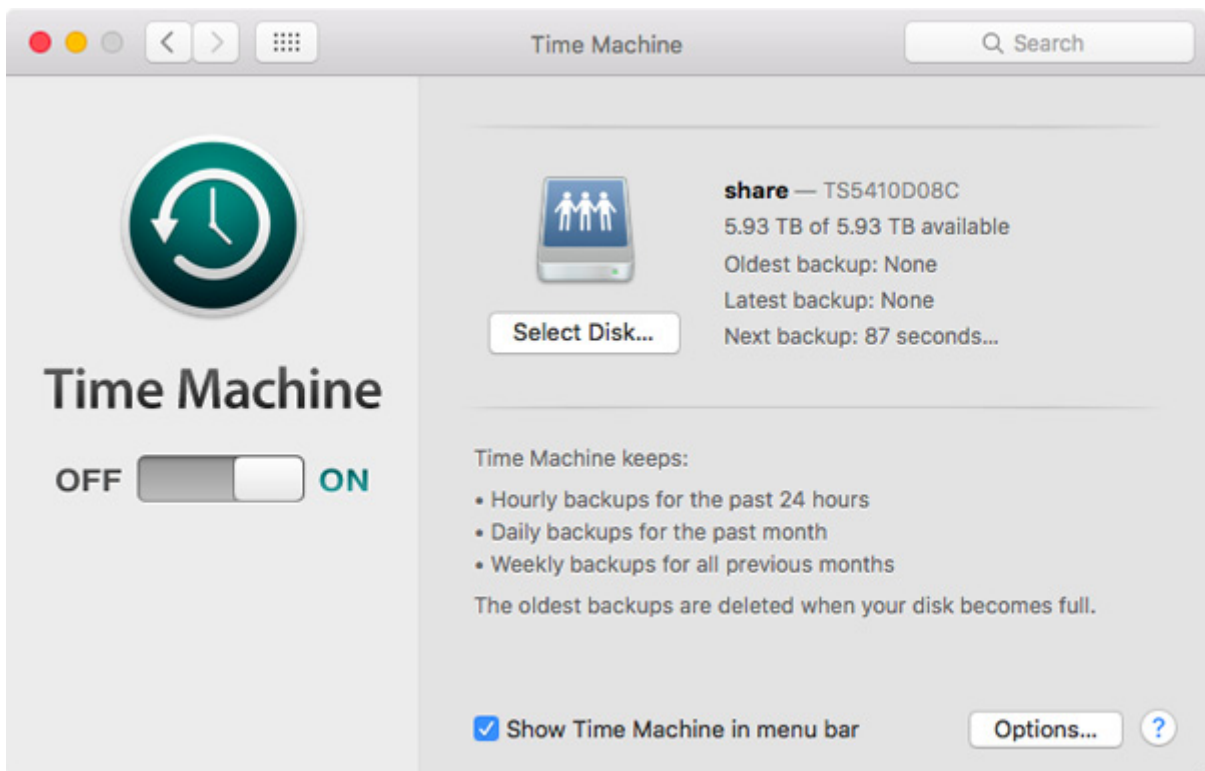

# Chapter 6 Remote Access

## WebAccess

WebAccess is a software utility for accessing the files in the shared folder of your TeraStation from your computer or mobile devices through the Internet. **Be careful when configuring WebAccess. Certain settings can make the files in the shared folder available to anyone on the Internet, without any access restrictions.**

### Notes:

- You can also configure WebAccess from Easy Admin.
- WebAccess supports downloading up to 60,000 files at a time. Attempting to download up to 60,000 files at a time may result in unexpected behavior.

**1** In Settings, click *File Sharing*.

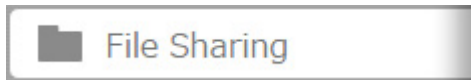

**2** Click  to the right of "WebAccess".

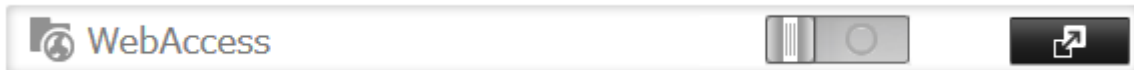

**3** Click *Edit*.

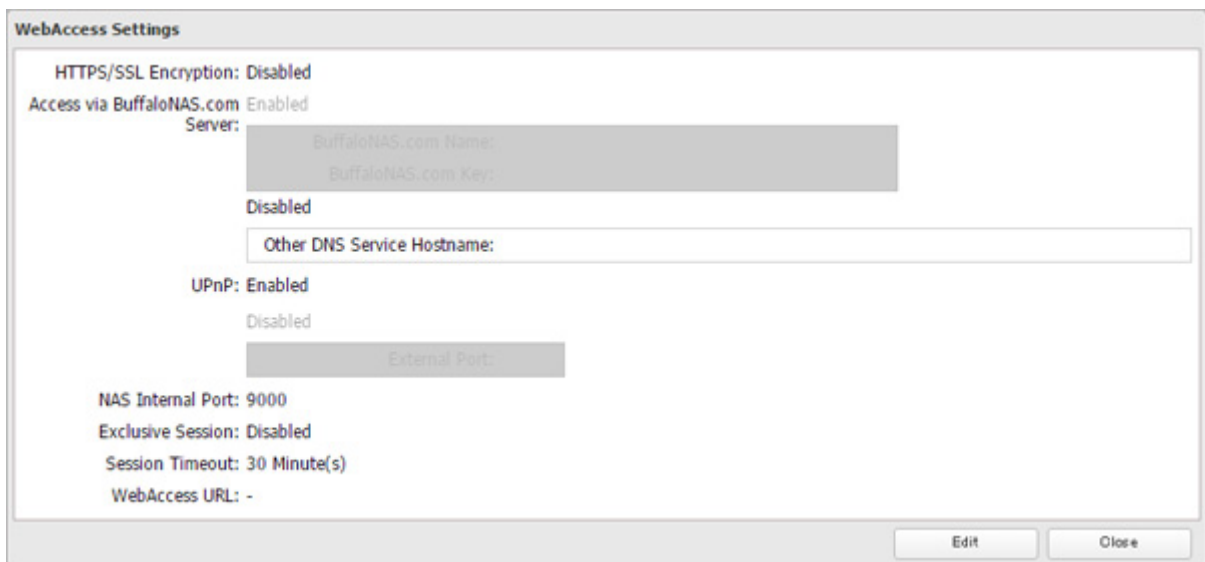

**4** Configure the desired settings, then click *OK*.

- You may use the BuffaloNAS.com server as a DNS server, or disable it to use a different DNS server.
- Choose a "BuffaloNAS.com Name" and "BuffaloNAS.com Key" for your WebAccess account. Names and keys may use 3 to 20 alphanumeric characters, underscores (\_), and hyphens (-).
- If "Exclusive Session" is enabled, multiple users cannot be logged in to WebAccess at the same time. Only the last login will be active.
- Enter a time in minutes (1 to 120, or "Unlimited") before inactive users are logged out of WebAccess.

**5** Click *OK*.

**6** Move the WebAccess switch to the  position to enable WebAccess.

**7** Click  to the right of "Folder Setup".



**8** Select a shared folder to publish.

**Notes:**

- For best results, create a new dedicated share for WebAccess.
- When accessing shared folders through WebAccess from a remote location, a username and password may be required for certain operations. For best results, create a user account with permissions on the WebAccess share before using WebAccess.

**9** Click *Edit*.

**10** Under "LAN Protocol Support", check "WebAccess" and click *OK*.

**Notes:**

- The following levels of security are available:  
"Allow anonymous" - Anyone can access (view) shared folders.

"Allow all groups and users" - All groups and users registered on the LinkStation or TeraStation can use WebAccess.

"Use inherited folder permissions" - Users and groups have the same access permissions with WebAccess that they do locally. If access restrictions are not set for the shared folder, then this option will not be shown.

- When a user or group can access a folder through WebAccess depends on a combination of WebAccess settings and the shared folder's settings.

Folder setup	WebAccess permissions	Allow anonymous		Allow all groups and users		Use inherited folder permissions	
	Folder attribute	Read and write	Read only	Read and write	Read only	Read and write	Read only
WebAccess account	Not logged in	R	R	-	-	-	-
	User with read and write access	R/W	R	R/W	R	R/W	R
	User with read-only access	R/W	R	R/W	R	R	R
	Group with read and write access	R/W	R	R/W	R	R/W	R
	Group with read-only access	R/W	R	R/W	R	R	R
	Other users	R/W	R	R/W	R	-	-

R: Read only, R/W: Read and write, -: No access

There are many ways to access WebAccess folders depending on your device.

- From a computer, supported browsers include Microsoft Edge, Firefox, Google Chrome, Internet Explorer 9 or later, Safari 9 or later.  
Instructions: <http://buffalonas.com/manual/en/>
- To access from an iOS device, install the "WebAccess i" application from the App Store.  
Instructions: <http://buffalonas.com/manual/i/en/>
- To access from an Android device, install the "WebAccess A" application from Google Play.  
Instructions: <http://buffalonas.com/manual/a/en/>
- To access from a Windows Phone, install "WebAccess" from the Windows Phone Store.  
Instructions: <http://buffalonas.com/manual/wp/en/>

## FTP

By default, the TeraStation's shares are only accessible by users connected to the same network or router as the TeraStation. The optional FTP server allows users outside the local network to access the TeraStation.

**Note:** FTP is intended for users who already have FTP client software and have experience with it.

- 1 In Settings, move the FTP switch to the  position to enable FTP.



- 2 Click  to the right of "Folder Setup".



- 3 Choose a folder to enable remote FTP access on.

**4** Click *Edit*.

**5** Select read-only or read and write for the shared folder's attribute; under "LAN Protocol Support", select the "FTP" checkbox and click *OK*.

### Accessing the TeraStation with an FTP Client

- To access the TeraStation via FTP, configure your FTP client software with the following settings:  
Hostname: IP address of the TeraStation  
Username: The TeraStation's username  
Password: The TeraStation's password  
Port: 21
- Shared folders connected by FTP are available from the "/mnt" directory. The default locations are:  
For a RAID mode other than RAID 1 (two arrays):  
/mnt/array1/share  
/mnt/usbdisk1  
/mnt/usbdisk2  
/mnt/usbdisk3 (if your TeraStation has 3 USB ports.)  
For RAID 1 (two arrays):  
/mnt/array1/share  
/mnt/array2/share2  
/mnt/usbdisk1  
/mnt/usbdisk2  
/mnt/usbdisk3 (if your TeraStation has 3 USB ports.)  
For JBOD:  
/mnt/disk1/share  
/mnt/disk2/share2  
/mnt/disk3/share3  
/mnt/disk4/share4  
/mnt/usbdisk1  
/mnt/usbdisk2  
/mnt/usbdisk3 (if your TeraStation has 3 USB ports.)

### Accessing the TeraStation with an Anonymous User\*

- To allow anonymous access to your FTP share, disable access restrictions.
- To access the TeraStation via anonymous FTP, configure your FTP client software with the following settings:  
Hostname: IP address of the TeraStation  
Username: anonymous  
Password: any character string  
Port: 21

\*If the TeraStation joins a domain, anonymous users cannot access it.

#### Notes:

- If a file was created or copied by AFP, you may not be able to delete it using an FTP connection. If this occurs, use an SMB or AFP connection instead to delete the file.
- For FTP connections, make sure that the total filename including directory path is 250 single-byte characters or less.

---

# Cloud Storage

---

The TeraStation supports Amazon S3, a fee-based online storage service provided by Amazon, and other cloud storage services that share the Amazon S3 API. Follow the procedure below to configure your TeraStation to use with your cloud storage service:

**Note:** Set the TeraStation's time settings to the correct time. Using NTP is recommended. To configure NTP settings on the TeraStation, refer to the "Name, Date, Time, and Language" section in chapter 7.

## Configuring Cloud Storage

---

**1** In Settings, click *Web Services*.

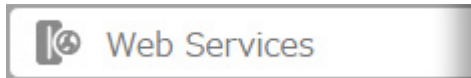

**2** Click  to the right of "Cloud Storage".



**3** Click *Add*.

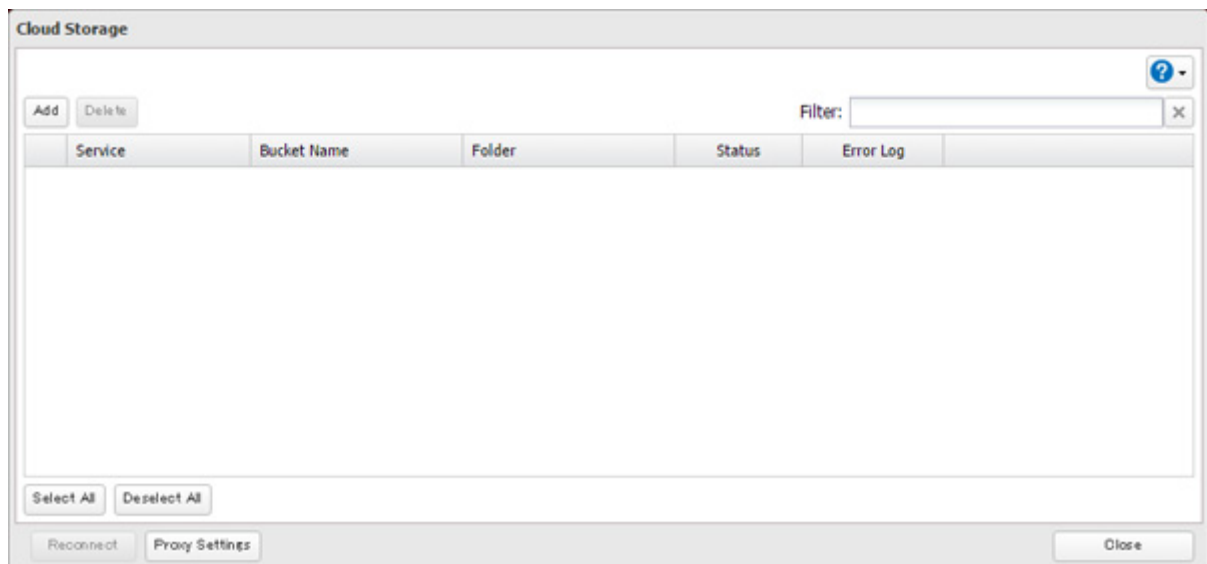

- 4 Select the service name from the drop-down list. Enter the bucket name, access key ID, and secret access key; select the storage class and the connection protocol, then click *OK*.

The 'Cloud Storage' dialog box contains the following fields and options:

- Service:** A dropdown menu with 'Amazon S3' selected.
- Target Hostname:** An empty text input field.
- Bucket Name \*:** An empty text input field.
- Access Key ID \*:** An empty text input field.
- Secret Access Key \*:** An empty text input field.
- Storage Class:** Radio buttons for 'Standard' (selected) and 'RRS'.
- Connection Protocol:** Radio buttons for 'http' (selected) and 'https'.

Buttons at the bottom: 'OK' and 'Cancel'. A red '\* Required' label and a help icon are in the top right corner.

- 5 Enter a shared folder name to use with the cloud storage service and click *OK*.

The 'Create Shared Folder' dialog box contains the following elements:

- Folder Name \*:** An empty text input field.

Buttons at the bottom: 'OK' and 'Cancel'. A red '\* Required' label and a help icon are in the top right corner. The text 'Create a shared folder to use for cloud storage on this TeraStation.' is displayed above the input field.

- 6 Under "LAN Protocol Support", select the "Backup" checkbox and enter the desired shared folder settings. Click OK.

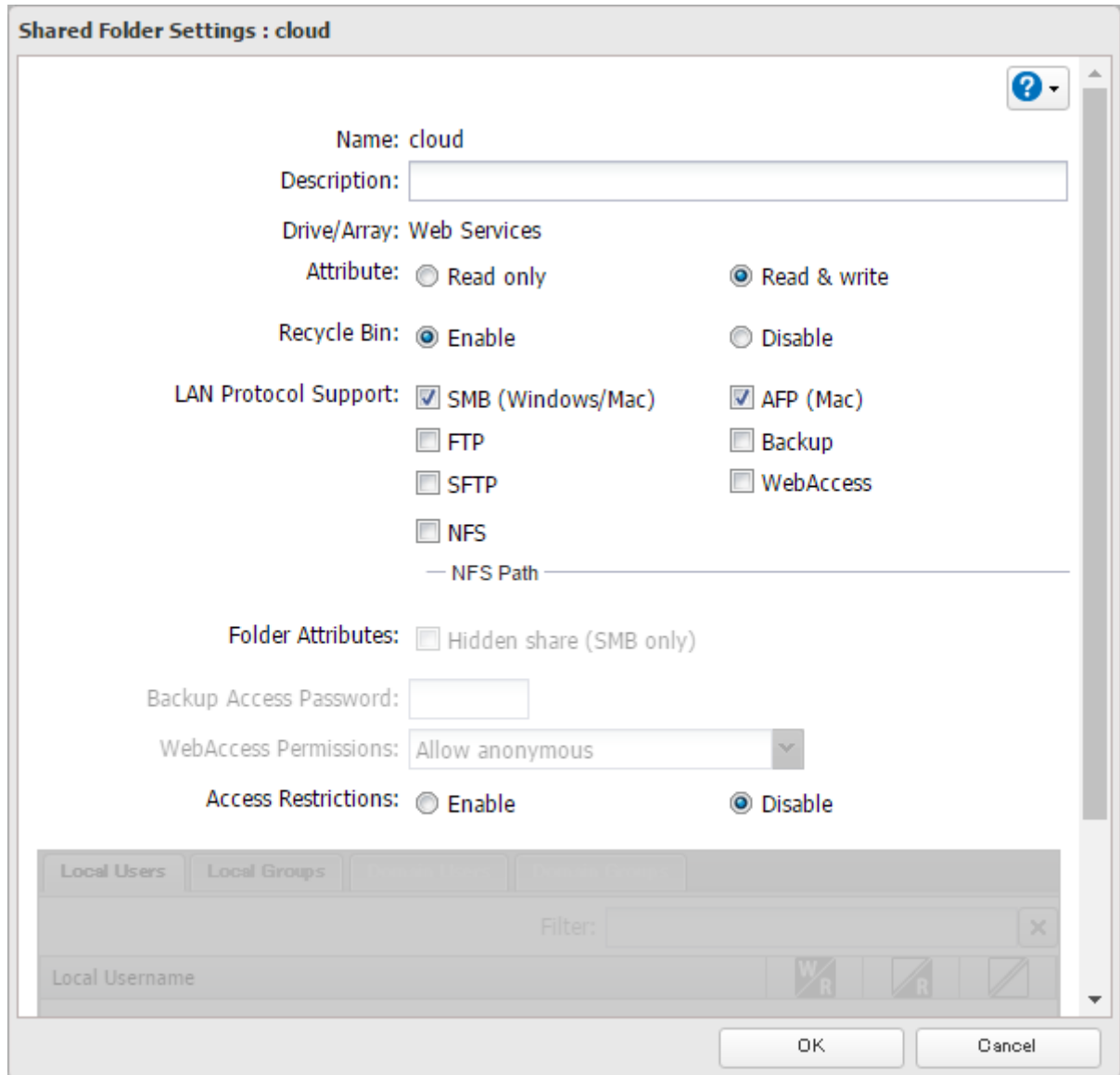

- 7 Click OK.

- 8 Click Close.

**Note:** Do not configure a folder that is created through the procedure above as replication destination folder.

## Uploading Files to Cloud Storage

To upload files to cloud storage, using backup job is recommended.

- 1 In Settings, click *Backup*.



- 2 Click  to the right of "Backup".



**3** Click *Create New Job*.

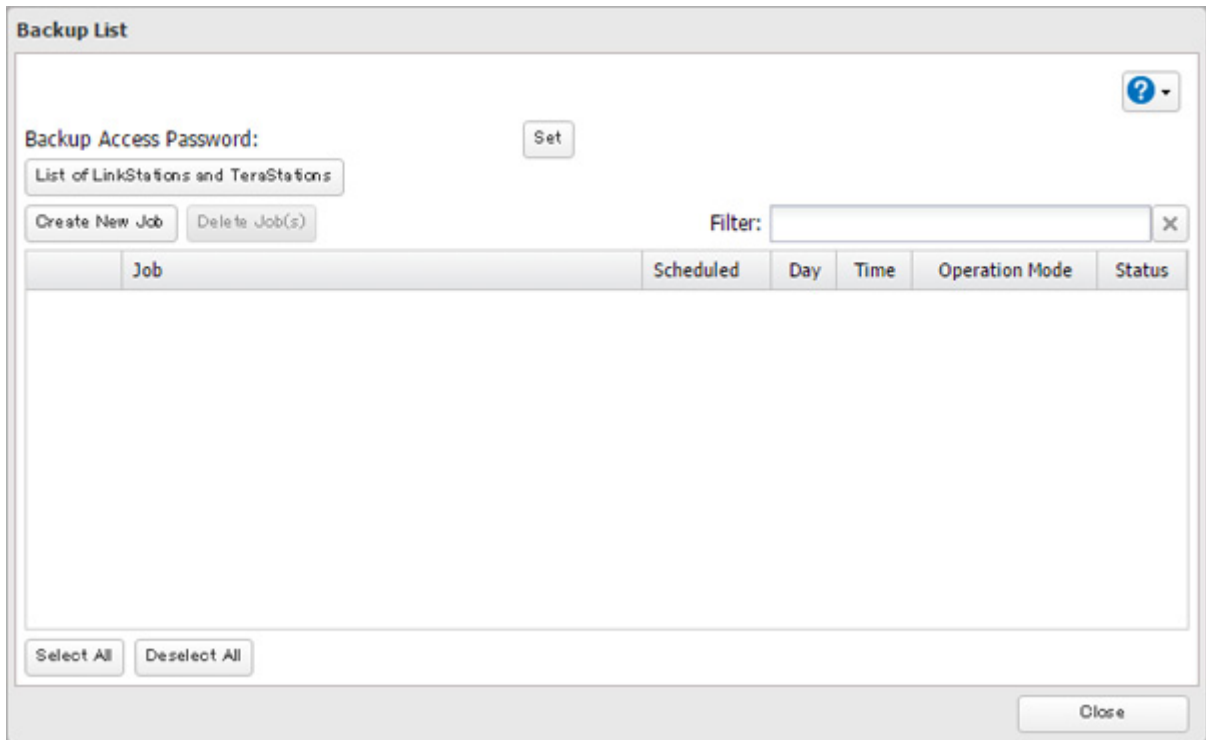

**4** Select backup settings such as date and time to run. It is recommended to configure a job to run periodically.

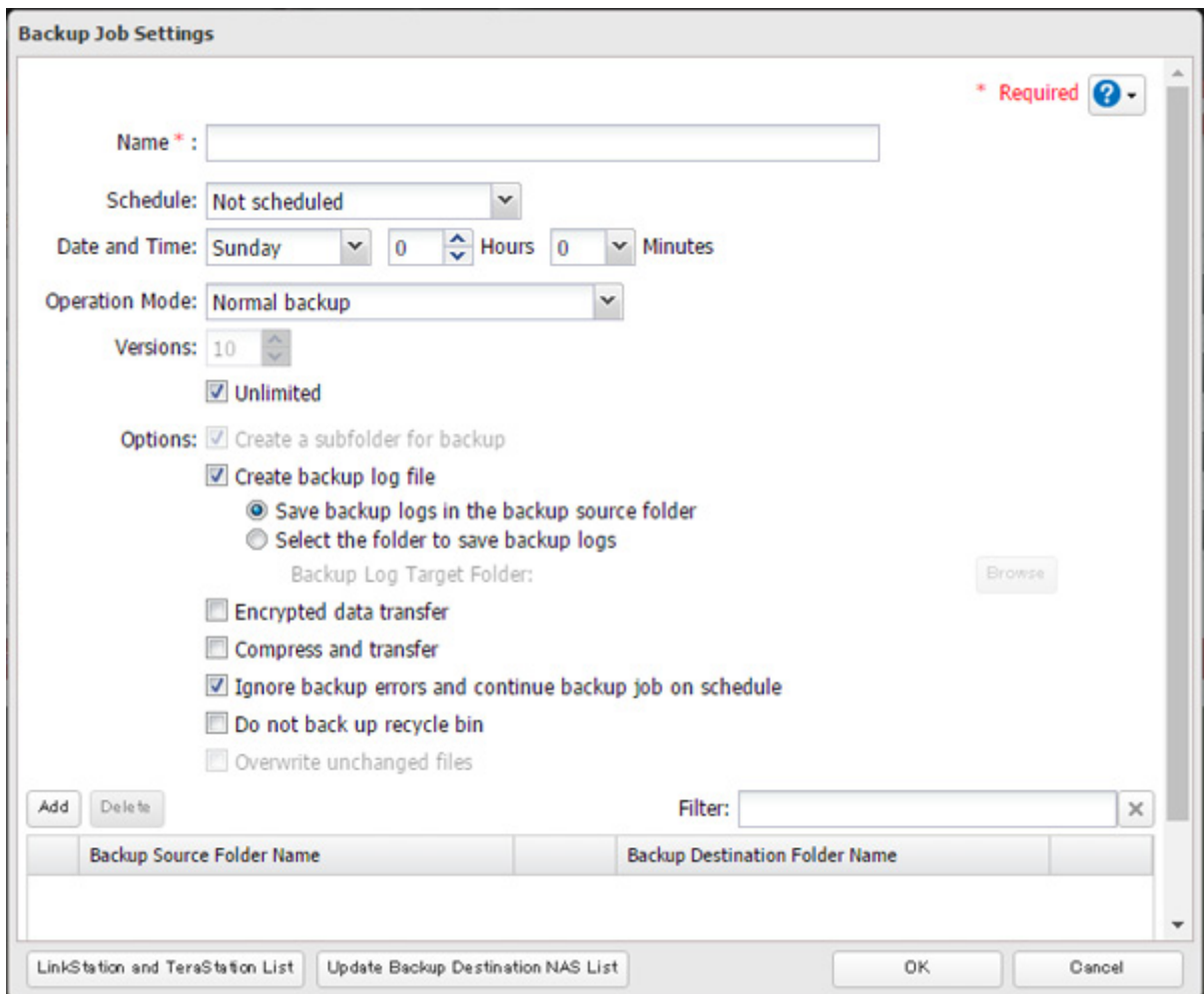

**5** Click *Add*.

**6** Click *Browse* under "Backup Source Folder Name".

**7** Select the shared folder that uploaded files will be saved to, then click *OK*.

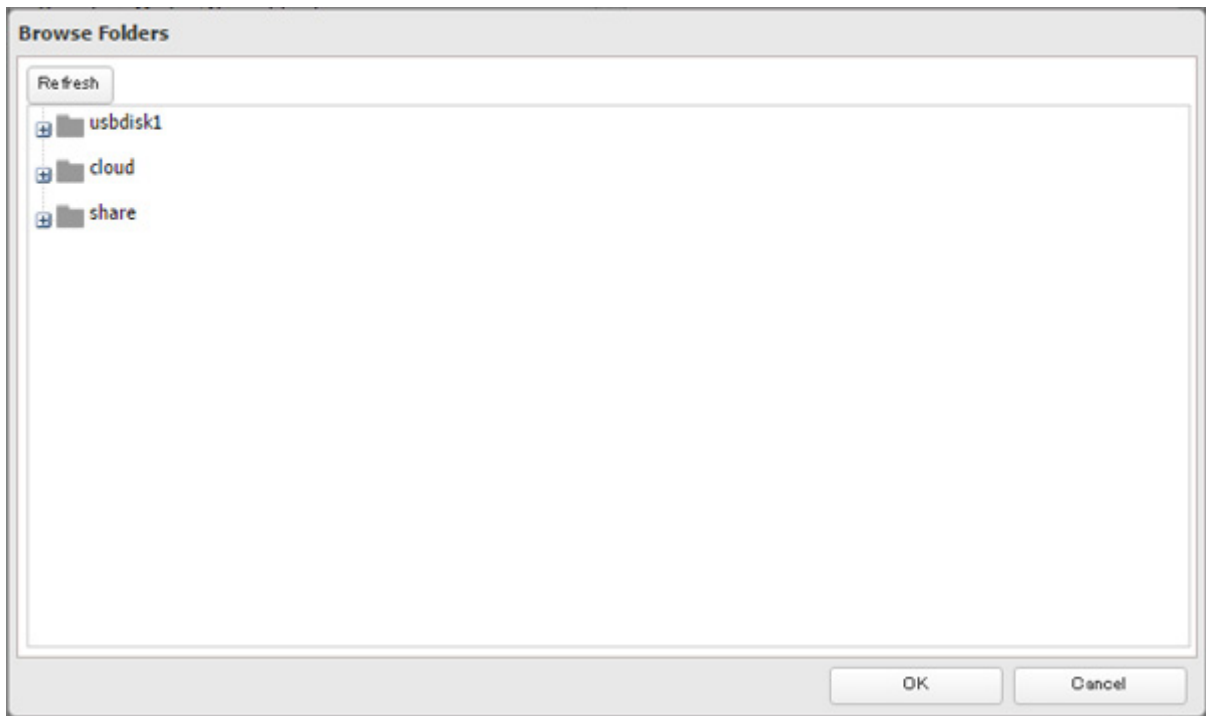

**8** Click *Browse* under "Backup Destination Folder Name".

**9** Select the shared folder created from the "Configuring Cloud Storage" section above, then click *OK*.

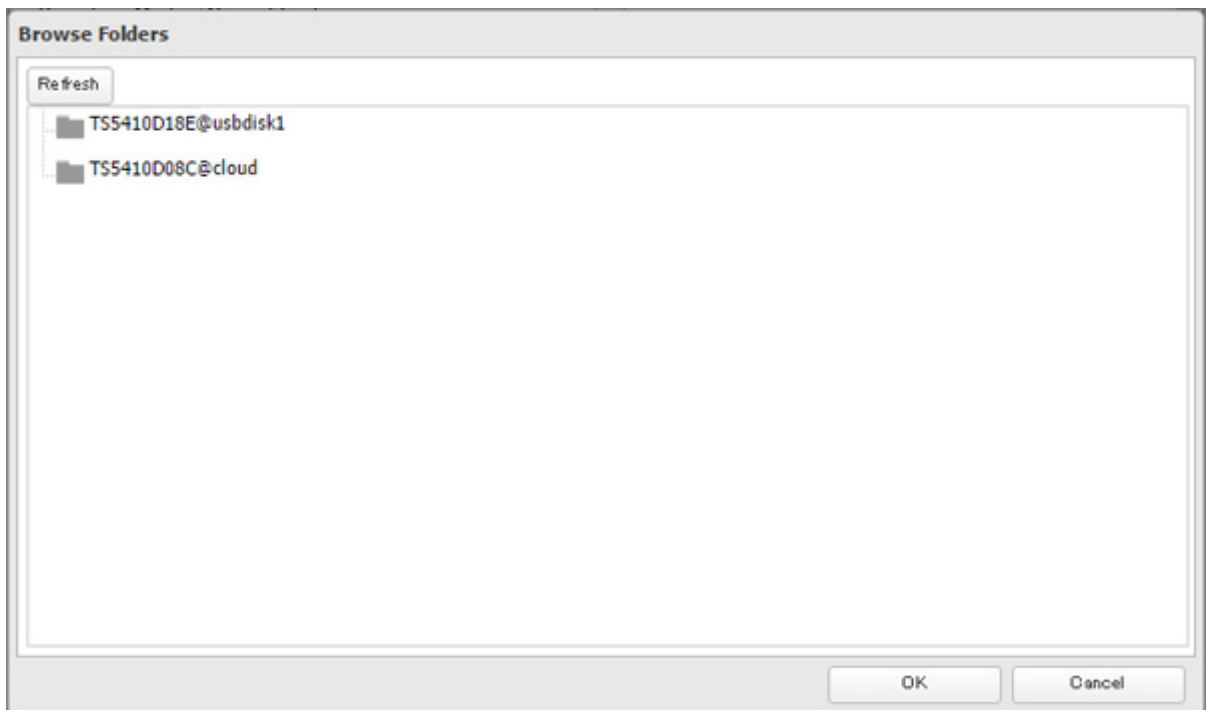

**10** Click *OK*. Tasks added to "Backup List" are displayed.

**11** Click *Close*.

**Notes:**

- If a shared folder created through this process is configured to use NFS, it cannot be mounted from an NFS client.

- Files cannot be uploaded to this shared folder using WebAccess.
- If using the cloud storage through a proxy server, click *Proxy Settings*. In the displayed page, you can select if using the configured settings or setting identical proxy server. If using the identical proxy server, select "New settings" and enter the proxy server name, port number, username, and password. Ask your network administrator for detailed proxy server settings.
- To use after the network was temporarily disconnected, click *Reconnect*.
- If a file is added to the bucket from a folder other than the TeraStation's remote replication folder, it may take more than an hour for the file to appear in the TeraStation's remote replication folder. However, when a file is added to the TeraStation's remote replication folder, it immediately appears in the bucket.
- If you enter an incorrect bucket name and then cancel editing the cloud storage service settings, that wrong bucket name may still accidentally be registered. If this happens, reconfigure the cloud storage service settings correctly starting from step 4.
- Be careful with existing files in the destination folder, as files with the same name will be overwritten even if copied files are older.
- If you copy a file to the remote folder using File Explorer or a backup process, the file will also be uploaded sequentially to the cloud storage bucket. This second uploading process will start in the background during the first copying process and will not be visible. If the TeraStation is shut down or restarted immediately after copying a file to the remote folder, changing the settings, or disconnecting and reconnecting the Ethernet cable, the file may not be uploaded to the bucket. Try copying the file again if this occurs.
- If you encounter any upload or download errors, click *Error Log*. The log will display the filename and operation during which the error occurred.
- If uploading fails, try copying the file again. If it still fails, click *Reconnect* or set the cloud storage switch to off and on again, then restart the cloud storage service.
- If transferring or accessing 1 TB or more files from cloud storage, make sure there is enough free space on the TeraStation for temporary file caching. For example, when uploading 1 TB of files to cloud storage, it is recommended to keep at least 2 TB of free space available.

---

## Dropbox Sync

---

The TeraStation supports syncing with Dropbox, the online cloud service. Once connected, you can share TeraStation files via Dropbox (or Dropbox files via TeraStation). To link your TeraStation with your Dropbox account, follow the procedure below.

**Note:** To use Dropbox Sync, you need a Dropbox account and an available empty Dropbox folder. If you don't have a Dropbox account, or if you need to create a new empty Dropbox folder, refer to the Dropbox website.

### Configuring a New Task

---

- 1 In Settings, click *Web Services*.

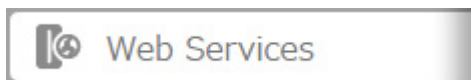

- 2 Move the Dropbox Sync switch to the  position to enable Dropbox Sync.



- 3 Click  to the right of "Dropbox Sync".



**4** Click *Add*.

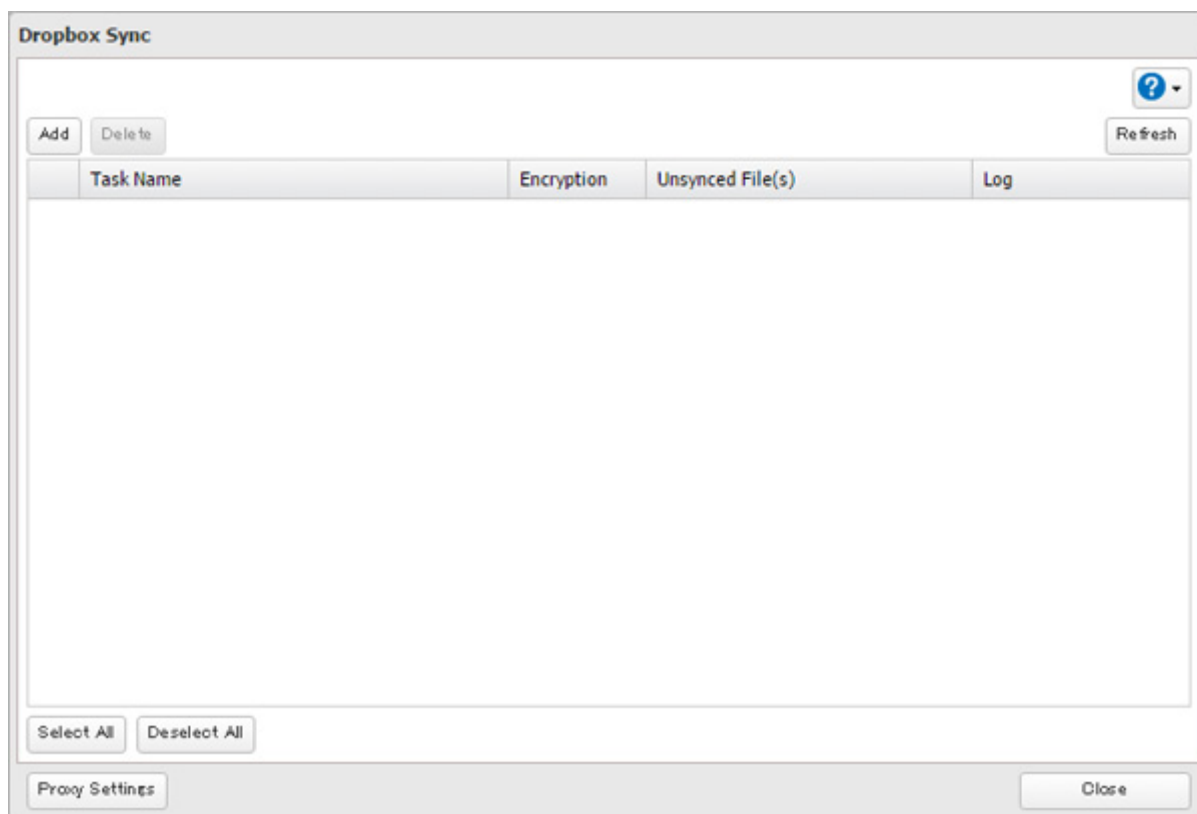

**5** Click *View Dropbox Authentication Page*.

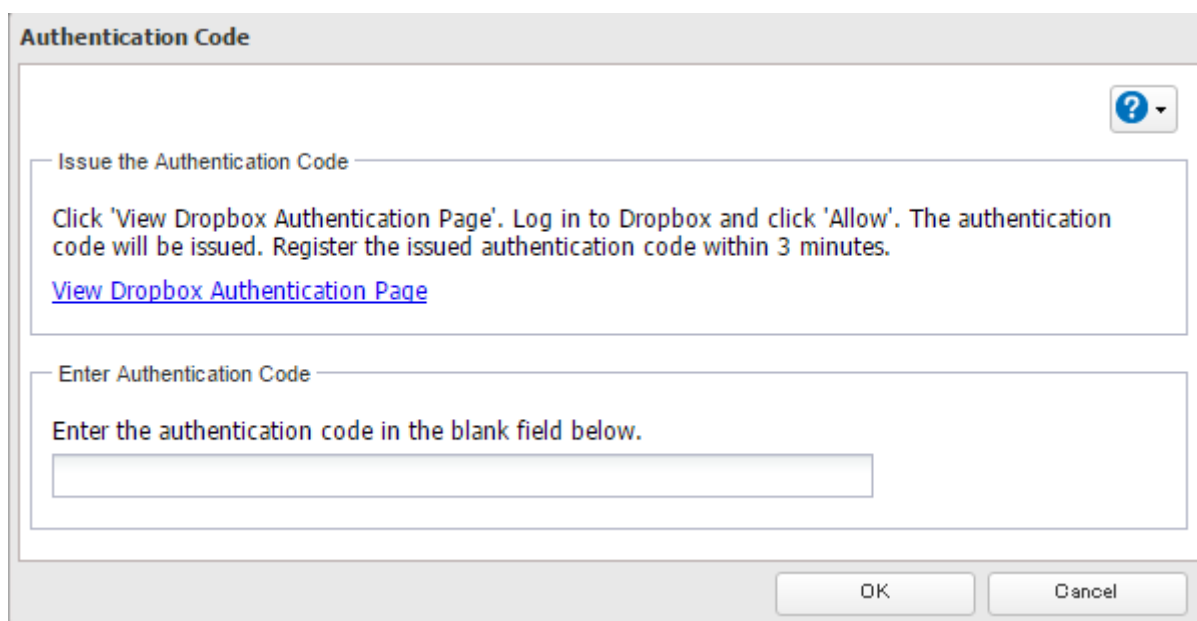

**6** The authentication site that is offered by Dropbox will be displayed. Log in to the website with your Dropbox account, then click *Allow*.

**7** The authentication code will be displayed. Copy the authentication code and return to Settings. Authentication code reregistration should be finished within 3 minutes.

**8** Paste the authentication code and click *OK*.

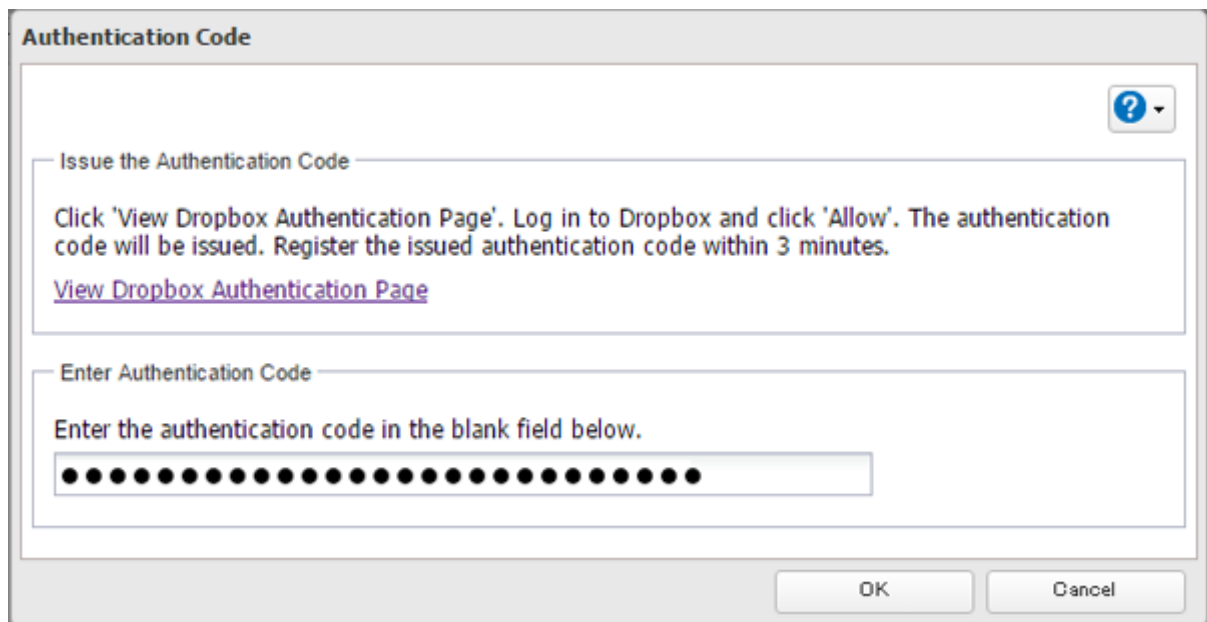

**9** Enter the desired task name; select the TeraStation and Dropbox folders, and configure encryption. Click *OK*.  
If you enable encryption, you will need to set an encryption password. The password cannot be changed once you configure it. Please take note of the password and keep it secure. If you forget the password, create a new task using the same Dropbox account. The old task can then be deleted.

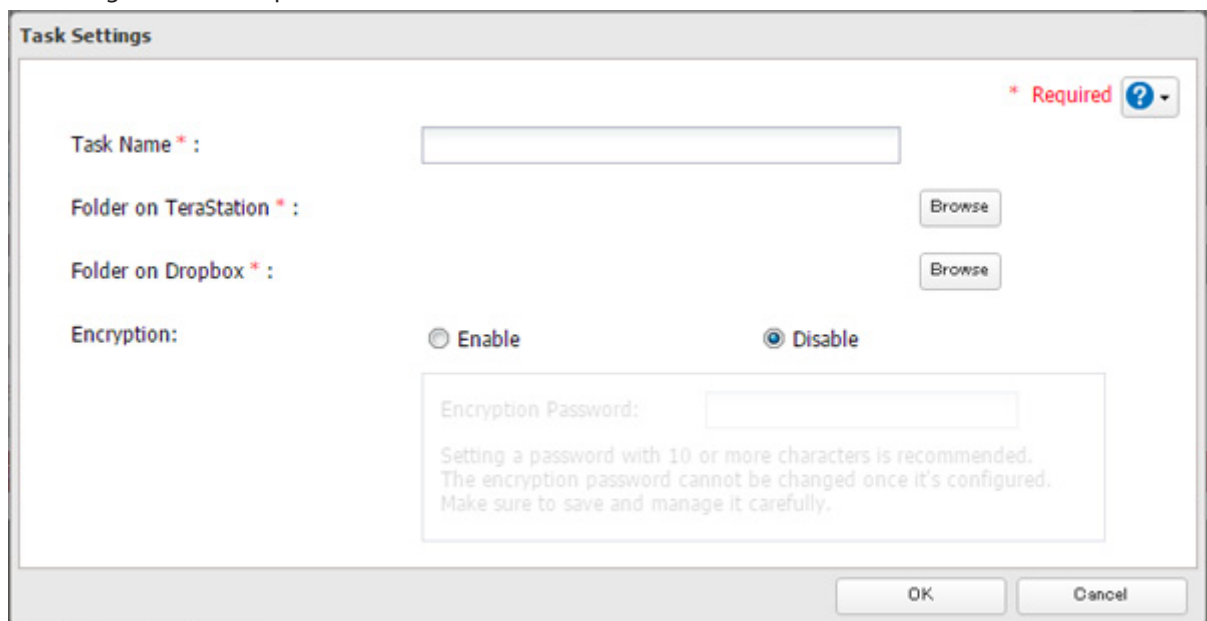

**10** Click *OK*.

**11** Click *Close*.

## Changing Dropbox Task Settings

Follow the procedure below to change any task settings you have already configured.

**1** In Settings, click *Web Services*.



2 Click  to the right of "Dropbox Sync".

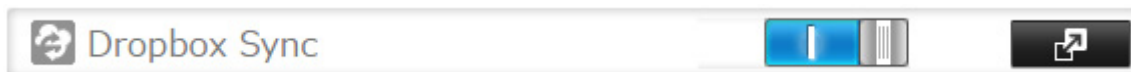

3 From the task list, click the task whose settings you want to change.

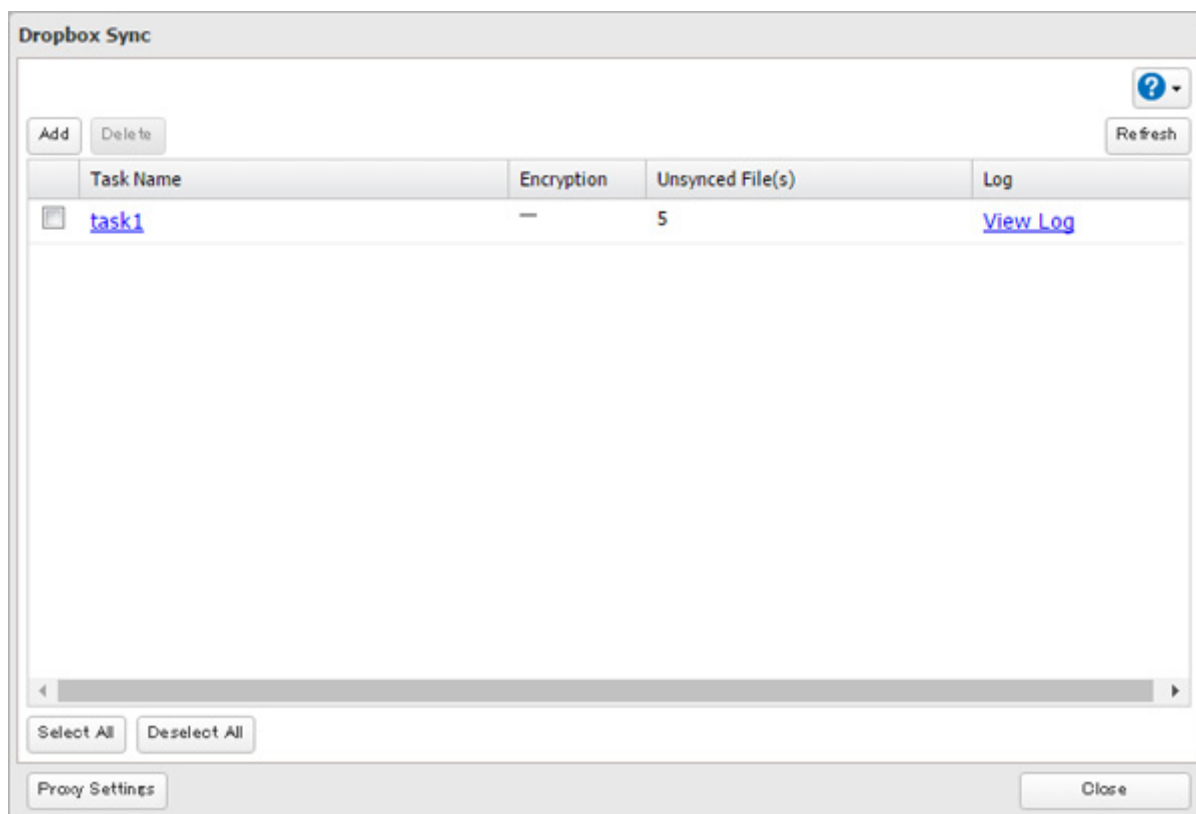

**4** Click the *Options* tab.

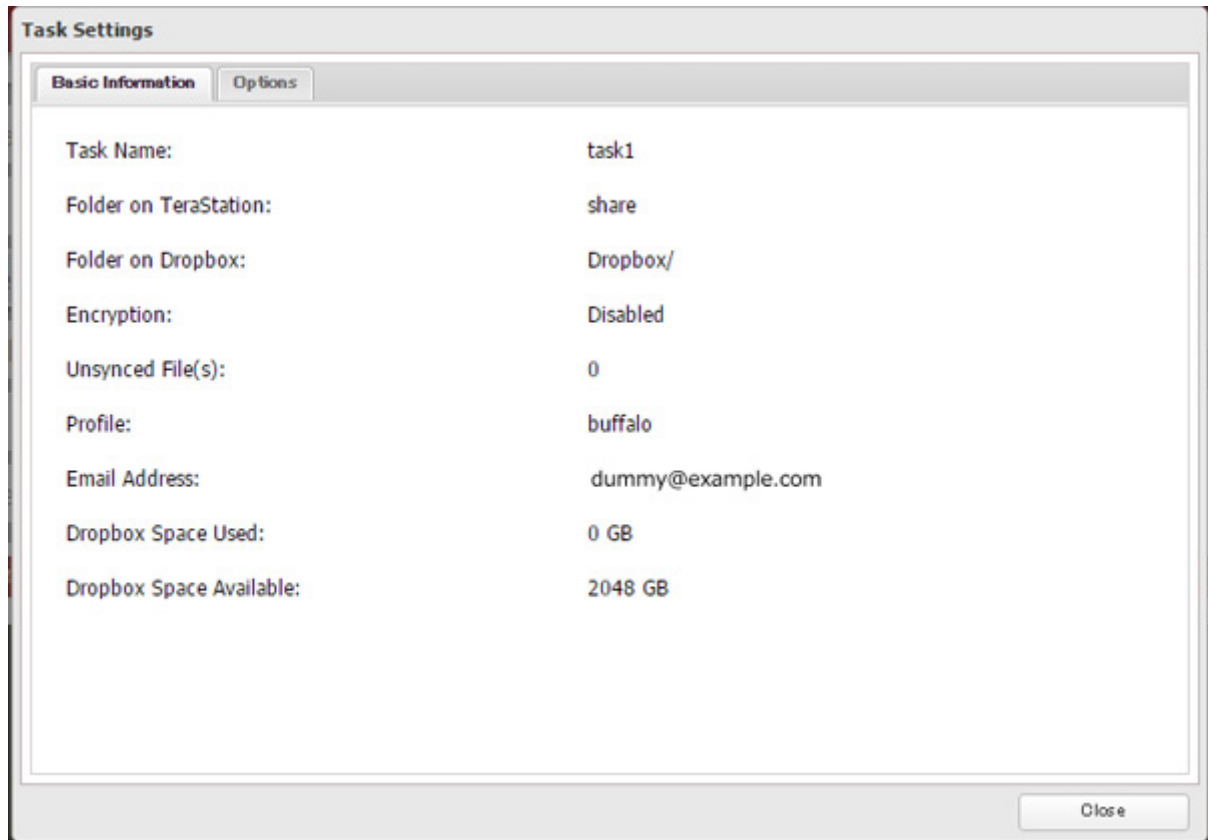

**5** Click *Edit*.

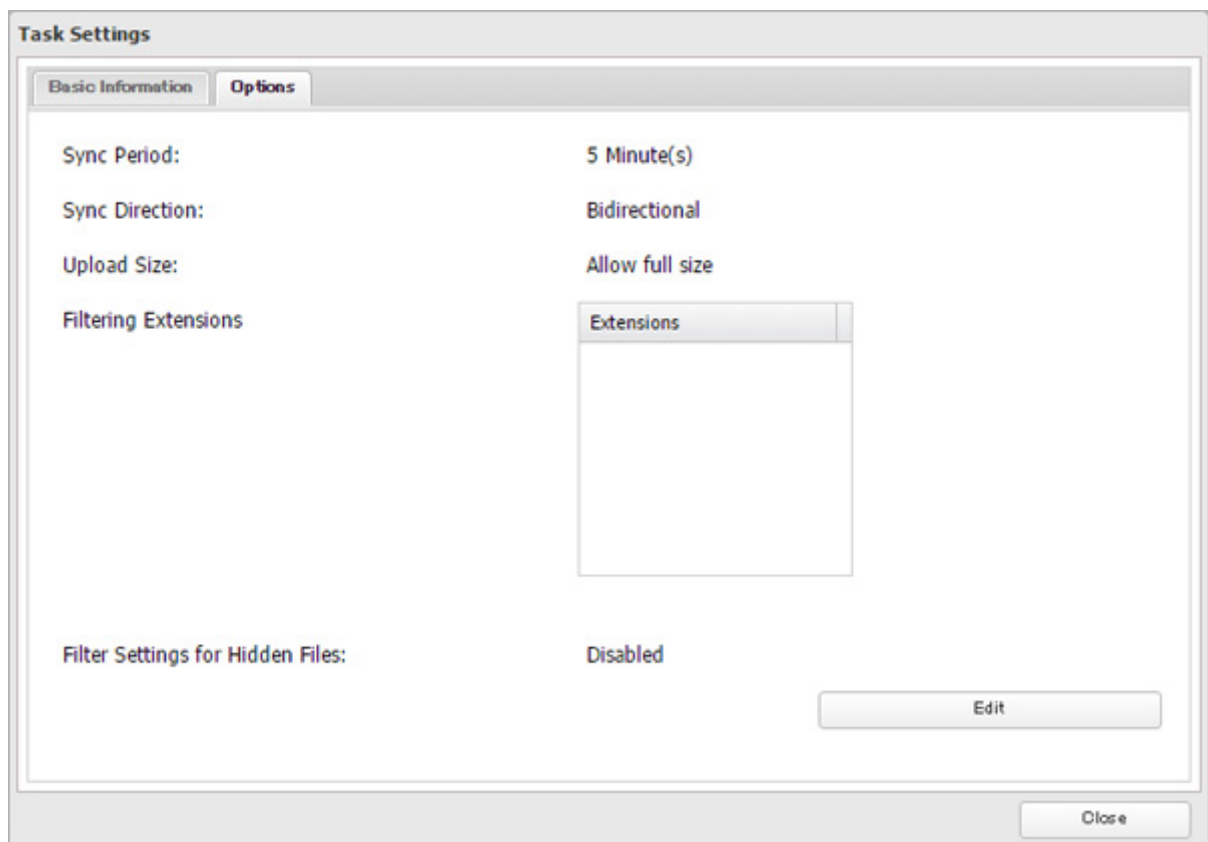

## 6 Configure the desired settings and click *OK*.

The screenshot shows the 'Task Settings' dialog box with the following configuration:

- Sync Period:** 5 Minute(s)
- Sync Direction:** Bidirectional
- Upload Size Limit:**  Limit size,  Allow full size
- Size Limit:** 1 MB
- Filtering Extensions:** An empty list with 'Add' and 'Delete' buttons.
- Filter Settings for Hidden Files:**  Enable,  Disable

### Notes:

- When encryption is enabled, files uploaded to Dropbox not using Dropbox Sync will not be downloaded to the TeraStation even if the sync direction is configured to "Bidirectional" or "Download only".
- Refer to the following website for synchronization restrictions between the TeraStation and Dropbox: <https://www.dropbox.com/help/145>
- Folders that are configured for Dropbox Sync cannot be renamed or used for replication.
- When specific settings are changed, the changes are not applied and the files on Dropbox may not be synced to the TeraStation. In such a case, delete the target files to be synced and upload them to Dropbox again or delete the task and recreate it again. The following are the specific circumstances when files may not be synced:
  - When uploading or downloading fails.
  - When file extensions are removed from filtering.
  - When the sync direction is changed.
- If using Dropbox through a proxy server, click *Proxy Settings*. In the displayed page, you can select if using the configured settings or setting identical proxy server. If using the identical proxy server, select "New settings" and enter the proxy server name, port number, username, and password. Ask your network administrator for detailed proxy server settings.
- Files that are 900 MB or larger cannot be downloaded using Dropbox Sync. However, even if the file size is smaller than 900 MB, downloading may fail when multiple processes are running at the same time.

## Creating a Shared Link (Windows Only)

Buffalo offers a Windows application, "B-Sync", that can create shared links for the files stored in the TeraStation folders. You can download the application from the Buffalo website. Refer to the application help for the usage procedure.

# Chapter 7 Advanced Features

## Email Notification

Your TeraStation can send you email reports daily, or when settings are changed or an error occurs. You can configure the events that will trigger notifications from any of the following functions:

Drive quota, drives (internal, external, or RAID array), fan, backup, replication, failover, system alert

Refer to the contextual help in Settings for more detailed information such as when the notification email will be sent or the differences between the notification categories.

- 1 In Settings, click *Management*.



- 2 Move the email notification switch to the  position to enable email notification.



- 3 Click  to the right of "Email Notification".

- 4 Click *Edit*.

- 5 Enter your email server settings, notification email's default subject, and configure recipients and the time when email reports will be sent. Click *OK* to send a test email.

If you select an authentication type other than "Disable" from the drop-down list, you can enter the sender email address and credentials of the email server.

**6** To change the events of email reports, click *Advanced Report Settings*. On the displayed screen, select or clear the category's checkboxes.

Categories		<input checked="" type="checkbox"/> Daily Report	<input checked="" type="checkbox"/> Info	<input checked="" type="checkbox"/> Notice	<input checked="" type="checkbox"/> Error
Drive Quota	User			<input checked="" type="checkbox"/>	
	Group			<input checked="" type="checkbox"/>	
Drives	Internal Drive	<input checked="" type="checkbox"/>	<input checked="" type="checkbox"/>	<input checked="" type="checkbox"/>	<input checked="" type="checkbox"/>
	RAID Array	<input checked="" type="checkbox"/>	<input checked="" type="checkbox"/>	<input checked="" type="checkbox"/>	<input checked="" type="checkbox"/>
	USB Drive	<input checked="" type="checkbox"/>			<input checked="" type="checkbox"/>
Fan					<input checked="" type="checkbox"/>
Backup			<input checked="" type="checkbox"/>	<input checked="" type="checkbox"/>	
Replication				<input checked="" type="checkbox"/>	
Failover			<input checked="" type="checkbox"/>	<input checked="" type="checkbox"/>	
System Alert			<input checked="" type="checkbox"/>		

The notification emails will be categorized into the following importance levels.

Levels	Details
Daily Report	Describes the status of the TeraStation in a daily report email.
Info	Sends a notification email if an event occurs. Info reports will contain just information such as capacity information, job starts/finishes, etc.

Levels	Details
Notice	Sends a notification email if a non-critical error occurs. Notice reports will contain warnings such as something has failed, but the function or unit can continue operating as usual. It is recommended to do the corrective action for the notice as soon as possible.
Error	Sends a notification email if an error occurs. Error reports will describe critical failure which prevents a function or unit from operating. It is recommended to do the corrective action to for the error immediately.

## Sleep Mode

To save energy, you can specify times to put the TeraStation into sleep (standby) mode, during which the drive and LEDs are turned off.

- 1 In Settings, click *Management*.



- 2 Click  to the right of "Sleep Timer".



- 3 Click *Edit*.

- 4 Specify the timer interval, wake-up time, and time to go into sleep mode, then click *OK*.

 A screenshot of the "Sleep Timer Settings" dialog box. The dialog has a title bar with a question mark icon on the right. It contains three sections for "Timer 1", "Timer 2", and "Timer 3".
 

- Timer 1:** Schedule is set to "Weekly". Days checked are Monday, Tuesday, and Wednesday. Wake Up at: 07 Hours 00 Minutes. Begin Sleep at: 22 Hours 00 Minutes.
- Timer 2:** Schedule is set to "Disable". All days are unchecked. Wake Up at: 00 Hours 00 Minutes. Begin Sleep at: 00 Hours 00 Minutes.
- Timer 3:** Schedule is set to "Disable". All days are unchecked. Wake Up at: 00 Hours 00 Minutes. Begin Sleep at: 00 Hours 00 Minutes.

 At the bottom right of the dialog are "OK" and "Cancel" buttons.

## Notes:

- Up to three timers can be set.
- The time to enter sleep mode can be set from 12:00 a.m. to 3:45 a.m. of the next day.  
The time to wake from sleep mode can be set from 12:00 a.m. to 11:45 p.m.  
If the time to enter sleep mode is after 12:00 a.m., the wake-up time setting may be from 4:00 a.m. to 11:45 p.m.
- The time to enter sleep mode should not be set at the same time as or before the start time.
- If a timer is scheduled during a drive check, drive format, backup process, and backup job, or within 5 minutes of the current time, the TeraStation will not change to standby mode when the configured time is reached.
- If scheduled times in the timer overlap, operation is performed using the widest time interval.
- Examples of multiple timer settings are shown below.

### Example 1:

If running at a current time of 10:00 a.m. Wednesday

Timer 1: Daily 12:00–24:00

Timer 2: Not used

Timer 3: Not used

No operation is performed at 12:00 p.m. and the unit goes into sleep mode at 12:00 a.m.

### Example 2:

If running at a current time of 10:00 a.m. Wednesday

Timer 1: Daily 9:00–18:00

Timer 2: Wednesday 10:00–20:00

Timer 3: Not used

On days other than Wednesday, normal operation begins at 9:00 a.m. and the unit goes into sleep mode at 6:00 p.m. On Wednesday, the unit goes into sleep mode at 8:00 p.m.

### Example 3:

If running at the current time of 10:00 a.m. Wednesday

Timer 1: Daily 9:00–18:00

Timer 2: Wednesday 10:00–1:00 a.m. of the next day

Timer 3: Not used

On days other than Wednesday, normal operation begins at 9:00 a.m. and the unit goes into sleep mode at 6:00 p.m. On Wednesday, normal operation begins at 10:00 a.m. and the unit goes into sleep mode at 1:00 a.m. of the next day.

### Example 4:

If running at a current time of 10:00 a.m. Wednesday

Timer 1: Daily 9:00–18:00

Timer 2: Wednesday 7:30–22:00

Timer 3: Not used

On days other than Wednesday, normal operation begins at 9:00 a.m. and the unit goes into sleep mode at 6:00 p.m. On Wednesday, normal operation begins at 7:30 a.m. and the unit goes into sleep mode at 10:00 p.m.

- To wake the TeraStation from sleep mode manually, press and hold the power button for 3 seconds.

---

## Wake-on-LAN

---

The TeraStation supports Wake-on-LAN, which allows it to be turned on remotely.

- 1 In Settings, click *Network*.

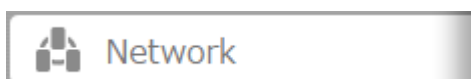

- 2 Click  to the right of "IP Address".



**3** Click *Edit*.

**4** Enable "Wake-on-LAN", then click *OK*.

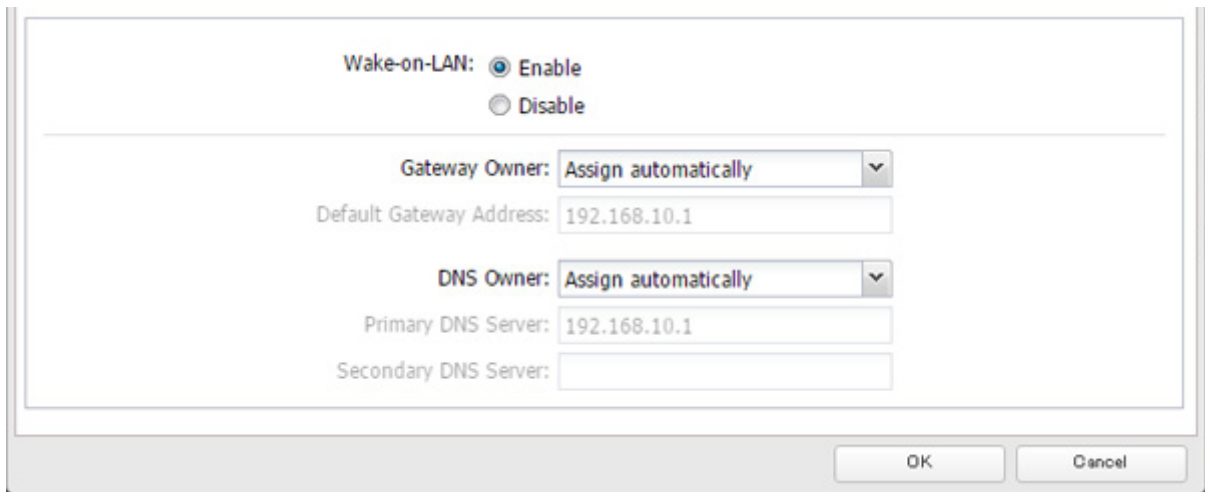

Wake-on-LAN:  Enable  
 Disable

Gateway Owner: Assign automatically

Default Gateway Address: 192.168.10.1

DNS Owner: Assign automatically

Primary DNS Server: 192.168.10.1

Secondary DNS Server:

OK Cancel

Wake-on-LAN is now enabled. As long as the TeraStation is connected to a power source and the network, you can turn it on remotely.

**Notes:**

- After receiving the Wake-on-LAN packet, the TeraStation may take approximately five minutes to be ready to use.
- If a power outage occurs while Wake-on-LAN is enabled, the TeraStation will automatically start up after power is restored.
- To use Wake-on-LAN, you'll need Wake-on-LAN software that sends magic packets. The TeraStation does not include Wake-on-LAN software.
- The TeraStation does not support using Wake-on-LAN and port trunking at the same time. You may use either feature, but not both at the same time.
- If the TeraStation is connected to a Buffalo wireless router configured for remote access, then it may be turned on from outside the local network (from the WAN side). To use this feature, connect the router to LAN port 1 or 2 on the TeraStation.

---

## UPS (Uninterruptible Power Supply)

---

If a UPS (sold separately) is attached, the TeraStation can be automatically shut down to protect data in the event of a power outage.

**1** Plug the power cable of the UPS to a wall socket.

**2** Connect the AC cable of the TeraStation to the UPS.

**3** Connect the UPS and TeraStation.

**4** Turn on the UPS, then the TeraStation.

**5** In Settings, click *Management*.

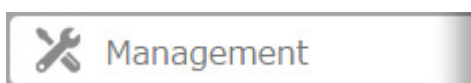

6 Click  to the right of "Power Management".



7 Click *Edit*.

8 Configure the desired settings, then click *OK*.

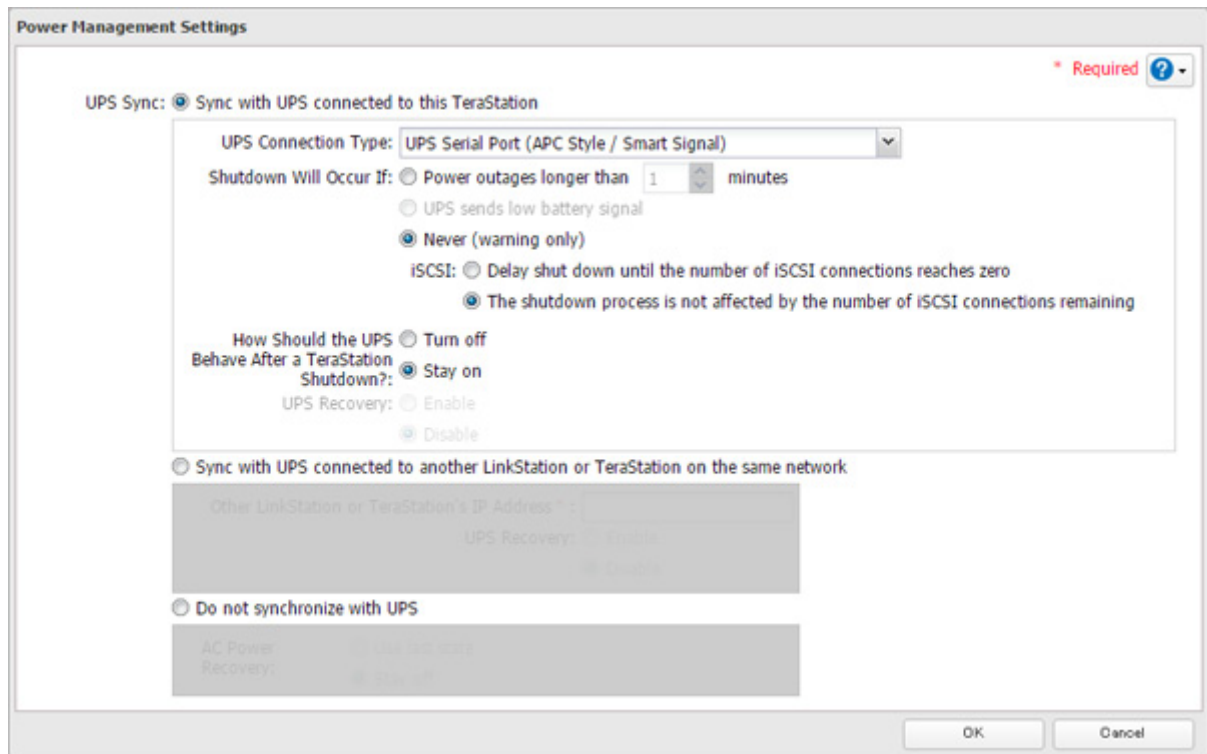

**Notes:**

- If the TeraStation is connected directly to a UPS, select "Sync with UPS connected to this TeraStation". If a different TeraStation is connected to the UPS, select "Sync with UPS connected to another LinkStation or TeraStation on the same network". After making this selection, enter the IP address of the TeraStation that will be the sync source in "Other LinkStation or TeraStation's IP Address".
- If you don't want to connect any UPS, select "Do not synchronize with UPS" and the operation when a power supply failure occurs. If "Use last state" at "AC Power Recovery" is selected, the TeraStation will revert to the state before the power supply failure occurs. If "Stay off" is selected, the TeraStation will keep off even after the TeraStation shuts down due to the power supply failure.
- When the TeraStation is restarted after an automatic shutdown such as from a power outage or power supply problem, verify that the power supply has been restored. If the TeraStation is turned on while it is still running on the UPS and without the power supply restored, automatic shutdown is not performed, even after the specified time has elapsed.
- If the power supply from the UPS to the TeraStation is stopped and restarted when UPS recovery is enabled, the TeraStation is automatically restarted.
- The "UPS sends low battery signal" will be grayed out when the UPS is connected to the TeraStation using a USB-to-serial converter cable.

# Port Trunking

Two Ethernet cables can be used to establish two separate communication routes, providing LAN port redundancy and improving communication reliability. The use of two Ethernet cables enables access to the TeraStation even if one of the cables is disconnected.

The port trunking modes that can be set in the TeraStation are shown below.

Trunking Mode	Characteristics
Active-backup	Only one NIC slave in the bond is active. A different slave becomes active if and only if the active slave fails.
Dynamic link aggregation*	Creates aggregation groups that share the network speed and duplex settings. Utilizes all slave network interfaces in the active aggregator group according to the 802.3ad specification.
TLB	The outgoing network packet traffic is distributed according to the current load (relative to the speed) on each network interface slave.

\* A separate intelligent switch that supports IEEE 802.3ad is required. Configure LACP in the switch first.

If the TeraStation is being used as an iSCSI drive, disable iSCSI before changing network settings such as port trunking. Navigate to *Storage - iSCSI* in Settings and move the iSCSI switch to the off position temporarily.

**1** Use an Ethernet cable to connect the hub LAN port and TeraStation LAN port 1.

**Notes:**

- Do not connect the second Ethernet cable to the TeraStation yet.
- If using an intelligent switch, configure the LAN ports on the switch first, before connecting to the TeraStation.

**2** In Settings, click *Network*.

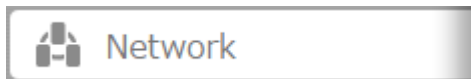

**3** Click  to the right of "Port Trunking".

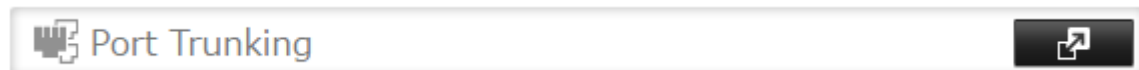

**4** Select the LAN port that will be used and choose a port trunking bond.

**5** Select the port trunking mode and click *OK*.

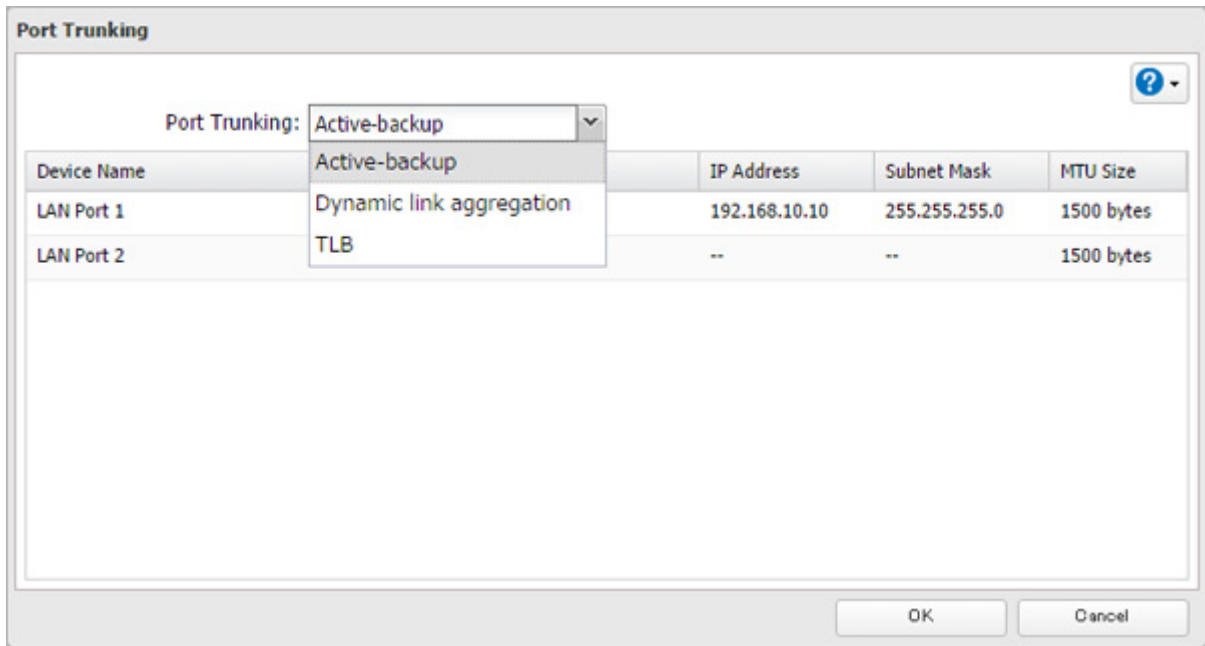

**6** Connect the hub's LAN port and TeraStation's LAN port using the second LAN cable. If you are using an intelligent switch, connect to the LAN port that was previously configured for port trunking.

**7** Restart the TeraStation before use.

---

## Offline Files

---

The "offline files" feature that is included with many versions of Windows can be used with files on the TeraStation. You will be able to work on files stored on the TeraStation even when your PC is disconnected from the network. When you next connect to the network, the updated files are written and synchronized. Follow the procedure below to configure offline files.

**1** In Settings, click *File Sharing*.

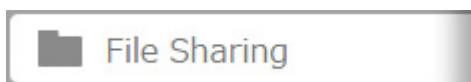

**2** Click  to the right of "Folder Setup".



**3** Click the shared folder for offline files.

**4** Click *Edit*.

**5** Choose "Manual caching of documents", "Automatic caching of documents", or "Automatic caching of programs and documents", then click *OK*.

- "Manual caching of documents" - User selects files that are cached.
- "Automatic caching of documents" - Opened files can be cached locally for offline use. Previous versions of files that are not synchronized are automatically replaced by the latest versions.

- "Automatic caching of programs and documents" - Opened files can be cached locally for usage offline. Previous versions of files and applications executed from the network that are not synchronized are automatically replaced by the latest version of the files and applications.

**6** Click *OK*.

**7** Click *Close*.

**8** Right-click the icon of the shared folder on the TeraStation for which you have set the offline feature, then click *Always available offline*. If the offline file wizard opens, follow the procedure on the screen.

**9** When the offline settings and sync settings are completed, the files and folders set appear as shown:

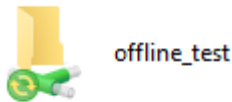

**10** If the computer is disconnected from the network after synchronization is completed, the offline file function can be used.

Offline files can be accessed by the original Universal Naming Convention (UNC) where the data was saved.

**Note:** If you cannot access offline files, try the following procedure:

- (1) Reconnect the computer to the network.
- (2) In Control Panel, change the view to the icon view and click *Sync Center*. Click *Sync All* to synchronize all offline files.
- (3) Disconnect the computer from the network and verify that you can access offline files.

## Accessing from an NFS Client

**Note:** (US customers only) Buffalo's customer support will help configure the NFS settings on your TeraStation, and will support VMware and Windows clients but will not provide support for configuring your Linux or other UNIX clients. There are many types of UNIX and the procedures for configuring NFS with them will vary considerably. For help configuring your NetWare, Linux, or other UNIX clients for NFS support, please consult each client's own documentation and support.

**1** In Settings, click *File Sharing*.

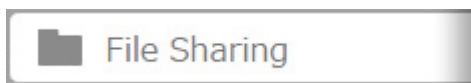

**2** Click  to the right of "Folder Setup".



**3** Choose the shared folder that will be accessible for the NFS client.

**4** Click *Edit*.

**5** Under "LAN Protocol Support", check "NFS" and click *OK*.

Note the NFS path. It will be used later for accessing data from an NFS client.

**6** Click *Close*.

7 Move the NFS switch to the  position to enable NFS.

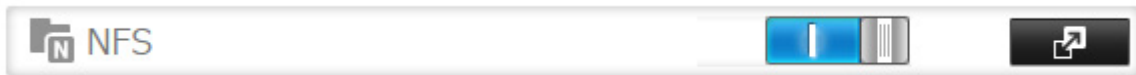

8 Click  to the right of "NFS".

9 Click the *Client Settings* tab.

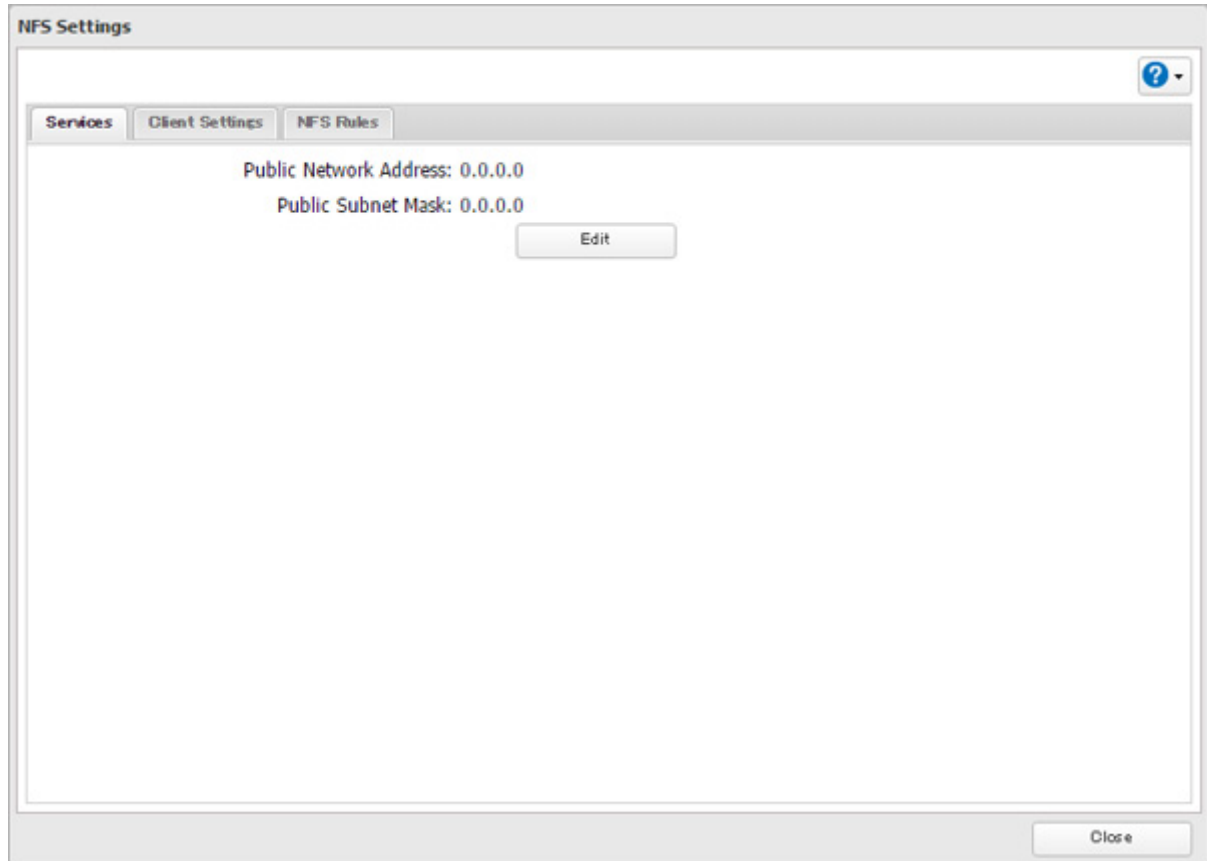

**10** Click *Add Client*.

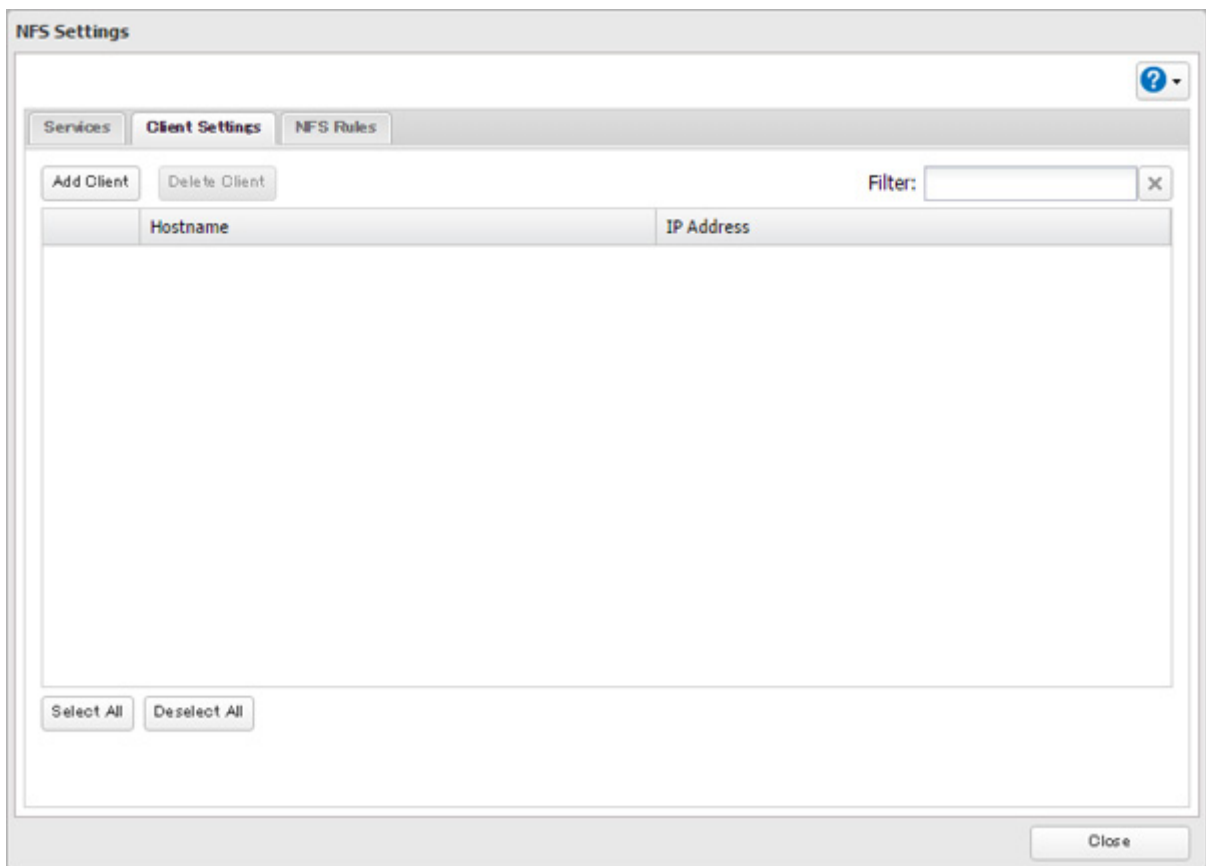

**Note:** To delete a client, select the checkboxes of the clients in the lists and click *Delete Client*.

**11** Enter the IP address and hostname of the NFS client, then click *OK*. You should add all NFS clients to access the shared folder.

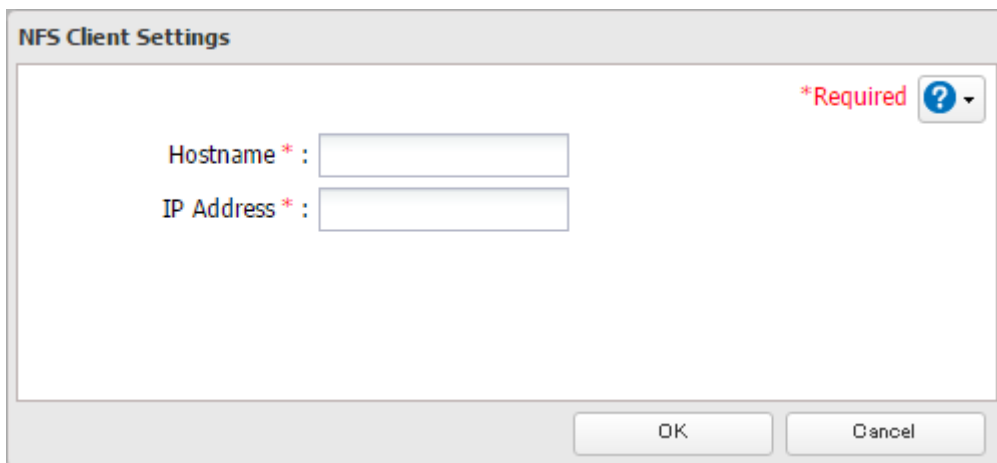

**12** Click the *NFS Rules* tab.

**13** Click *Add Rule*.

**14** Choose the folder to restrict access to, and enter the clients that will have restricted access into the "Hosts" field. Clients may be entered by hostname, IP address, or IP address range. Wildcards are supported. Separate

multiple entries with commas. You may assign read-only or read and write access to the listed clients. Rules override any settings made from the *Services* tab.

The screenshot shows the 'NFS Rule' configuration window. It includes a 'Folder \* :' field with a 'Browse' button, a 'Hosts \* :' text input field, and a 'Privilege:' section with radio buttons for 'Read & write', 'Read only', 'Sync', 'Async', 'Forced', and 'Ignored'. A red '\*Required' label with a question mark icon is located in the top right corner. 'OK' and 'Cancel' buttons are at the bottom.

**15** Click *OK*.

**16** Click *Close*.

**17** Enter the mount command to access the shared folder from the NFS client.

The mount command depends on your operating system. The examples below assume that IP address of your TeraStation is 192.168.11.10, "/mnt/array1/share" is the desired NFS path, and "/mnt/nas" or drive letter "z" is the mount point.

- **For Linux:**  
mount -t nfs 192.168.11.10:/mnt/array1/share /mnt/nas
- **For Windows Service for Unix 3.5:**  
mount 192.168.11.10:/mnt/array1/share z:
- **For Solaris 10:**  
mount -F nfs 192.168.11.10:/mnt/array1/share /mnt/nas
- **For macOS:**  
mount -t nfs -o resvport 192.168.11.10:/mnt/array1/share /mnt/nas

**Notes:**

- To restrict NFS access to a specific network or client, navigate to *File Sharing - NFS - Services* and click *Edit*. Enter the address of the network. For example, if your local network subnet has a router at 192.168.1.1 and clients with IP addresses in the range from 192.168.1.2 through 192.168.1.48 with subnet mask 255.255.255.0, then the "Public Network Address" would be 192.168.1.0 and the "Public Subnet Mask" would be 255.255.255.0. This would mean that only clients on this local network would be able to access the NFS share. If the default settings are used (0.0.0.0 for both the public network address and the public subnet mask), then access to the NFS share will not be restricted.
- If you configure "Guest Permission" to "Forced" on the screen navigating to *NFS Rules - Add Client*, user ID and group ID should be 65534 when the data is written from NFS clients; this is recommended for SMB or other protocols as well. Use "Ignored" if the TeraStation only enables NFS connection.

---

## Encrypting Data Transmission

---

### Encrypting Settings Data

---

All communication with Settings can use SSL encryption if you access the Settings page by changing "http://" to "https://" in the browser address bar or click *Secure Connection* from the login window.

## Encrypting FTP Transfer Data

---

### Using SSH Encryption

You can encrypt passwords using SSH for secure FTP communication. First, open a shared folder's settings and click *Edit*; under "LAN Protocol Support", select the "SFTP" checkbox and click *OK*. Also, you have to enable the SFTP service by moving the SFTP switch to the on position on "File Sharing".

### SSL Keys

---

SSL keys are used during setup screen operations and FTP communication. SSL (Secure Socket Layer) is a type of encryption system called public key encryption. Generally, SSL is managed by the two files below.

#### server.crt (SSL Certificates)

The TeraStation sends the file to a computer, and the computer uses it to perform encryption. The TeraStation receives the encrypted data and uses server.key (the private key) to decrypt the data.

In SSL, this key contains the server certificate, and depending on your computer environment, a check may be performed to determine the trustworthiness of the certificate. The server certificate included in the TeraStation in the default settings was created by Buffalo, and in some cases the message "There is a problem with this website's security certificate" may be displayed in your browser or other software. Disregard this message and continue.

#### server.key (SSL Private Key)

This file is used as a pair with server.crt (server certificate). This is required for decrypting the data that was encrypted by the server certificate, and this is normally not revealed.

**Note:** The passphrase for the private key must be removed before importing to the TeraStation.

### Updating SSL Key Files

To update a server certificate and a private key for SSL, follow this procedure.

- 1** In Settings, click *Management*.
- 2** Click *SSL*.
- 3** Register "server.key" for "Secret Key" and "server.crt" for "Server Certificate (.crt)", then click *Import*.

#### Notes:

- Place the SSL key files (server.key, server.crt) directly below the C root drive. The SSL key files may not be able to be updated if it is placed in folders or paths that contain multibyte characters.
- If Settings cannot be displayed after updating, initialize the TeraStation settings.
- Updating the firmware initializes an SSL key.

---

## SNMP

---

If SNMP is enabled, you can browse your TeraStation from SNMP-compatible network management software.

- 1** In Settings, click *Network*.



2 Click  to the right of "SNMP".

3 Click *Edit*.

4 Choose whether to use SNMP version 2 or version 3.

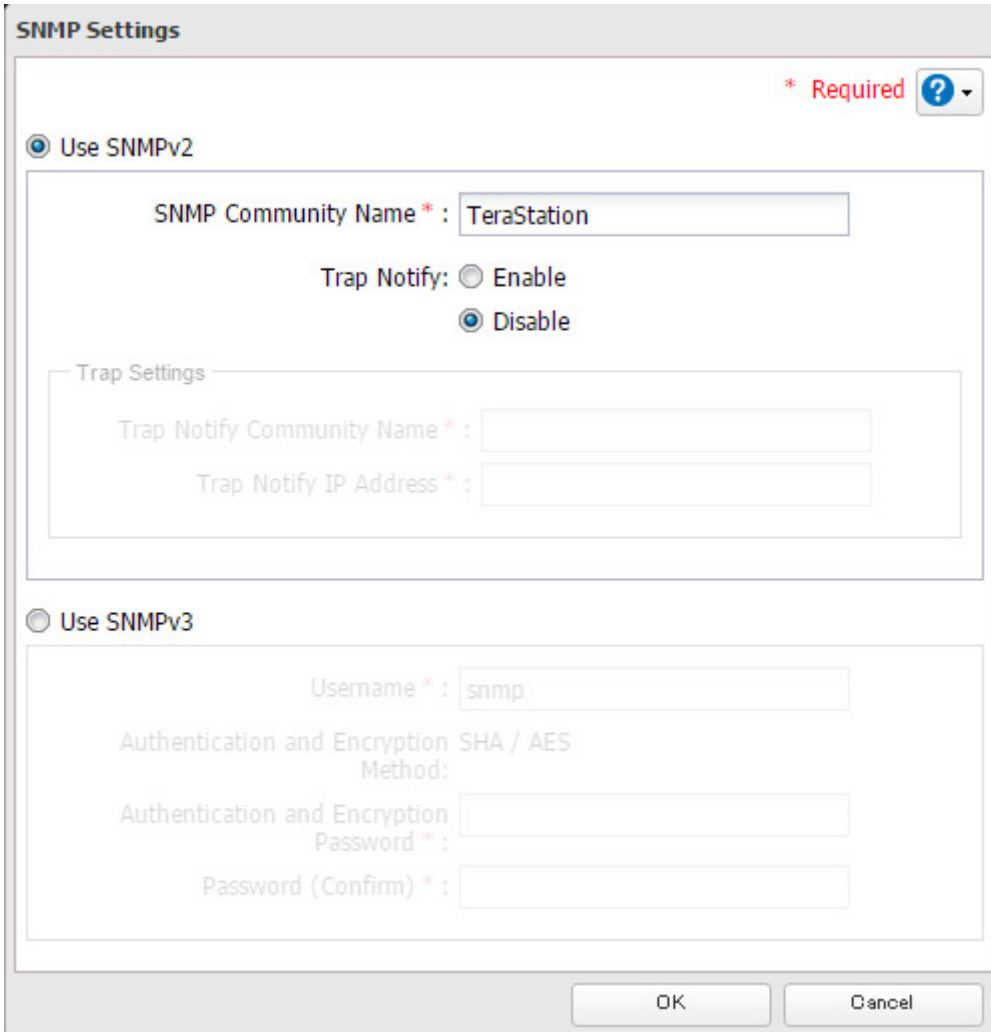

The image shows the "SNMP Settings" dialog box. At the top right, there is a red asterisk and the word "Required" next to a question mark icon. Below this, there are two radio button options: "Use SNMPv2" (which is selected) and "Use SNMPv3". Under "Use SNMPv2", there is a text field for "SNMP Community Name \*" containing "TeraStation". Below that are two radio buttons for "Trap Notify": "Enable" and "Disable" (which is selected). A "Trap Settings" section contains two text fields: "Trap Notify Community Name \*" and "Trap Notify IP Address \*". Under "Use SNMPv3", there is a text field for "Username \*" containing "snmp". Below that is a label "Authentication and Encryption Method:" followed by a dropdown menu showing "SHA / AES". There are also text fields for "Authentication and Encryption Password \*" and "Password (Confirm) \*". At the bottom of the dialog are "OK" and "Cancel" buttons.

5 Configure the desired settings, then click *OK*.

6 Move the SNMP switch to the  position to enable SNMP.

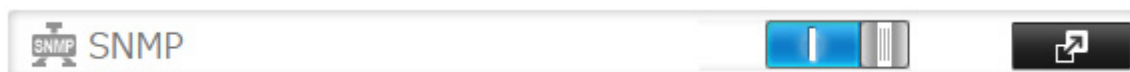

7 SNMP has been configured for the TeraStation. For further use, configure your SNMP-compatible network management software using the Buffalo-specific MIB (management information base) file. The MIB file is available from the Buffalo website.

Depending on which SNMP client software you use, the procedure for configuring the software will differ. For more detailed information on configuring the client software, refer to its help or included manual.

---

## Saving and Applying Settings

---

The TeraStation's settings can be saved to a USB drive and restored to another TeraStation of the same series. Use this function to back up and copy settings to a new TeraStation.

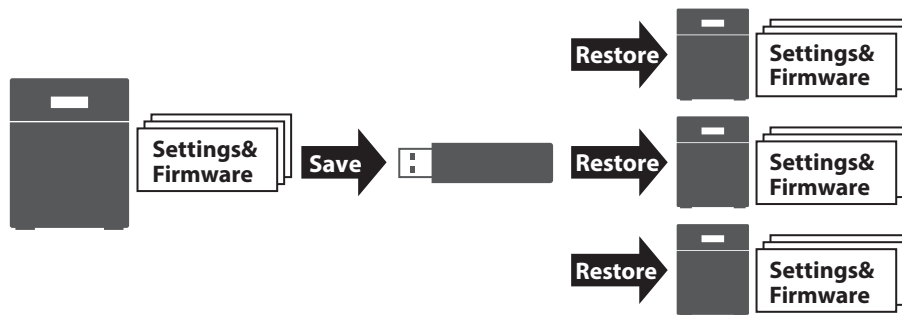

Make a note of the drive configuration (number of drives, RAID, LVM, etc.) of the TeraStation whose the settings were saved. Make sure that any TeraStation that you apply these settings to has exactly the same drive configuration before you apply the settings. If the drive configuration is different, you may get unexpected results.

The following settings are not saved or restored:

Category	Settings
File Sharing	Shared folder information of the USB drive
Storage	All settings in "Drives"
	All settings in "LVM"
	All settings in "iSCSI"
	USB drive information
Web Services	Task settings of Dropbox Sync
Network	All settings except for service port restrictions, Wake-on-LAN, and MTU size settings in "IP Address"
	All settings in "Port Trunking"
Backup	All settings in "Failover"
Management	The TeraStation's hostname
	All settings in "Power Management"
	All settings in "SSL"
	Display language in Settings

## Saving Settings

- 1 Insert a 1 GB or larger USB drive (not included) into a USB port on the TeraStation.

**Note:** All data on the USB drive will be erased!

- 2 In Settings, click *Management*.



- 3 Click  to the right of "Configuration Management".

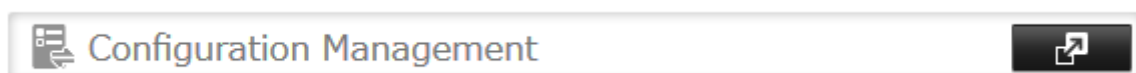

**4** From "Target USB Drive", select the USB drive that is connected to the USB port on the TeraStation.

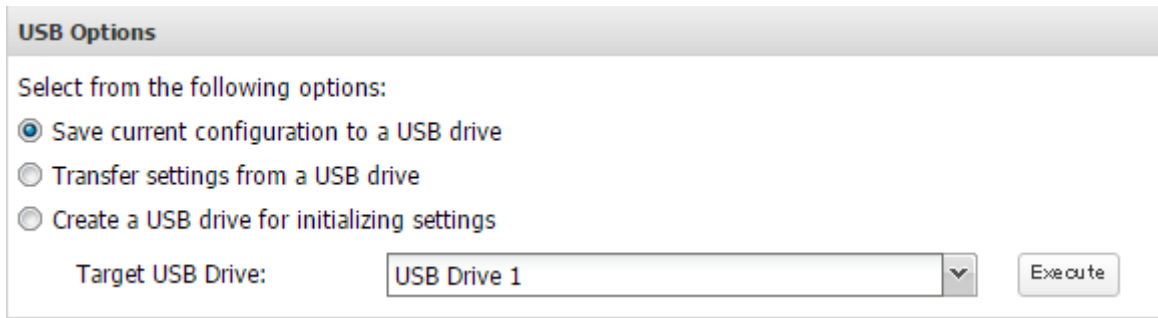

**5** Select "Save current configuration to a USB drive", then click *Execute*.

**6** The "Confirm Operation" screen will open. Enter the confirmation number, then click *OK*. The TeraStation will save the settings.

**7** When the "finished" message is displayed, saving settings is finished. Click *OK*.

## Troubleshooting:

If the settings are not saved to the USB drive successfully, you may receive the error message "The specified operation cannot be executed.". Verify:

- The USB drive has a capacity of 1 GB or larger.
- The USB drive is not write-protected.

## Applying Settings

---

The saved settings can be applied to a different TeraStation of the same series. If applying settings to another TeraStation, the unit's current firmware version will be changed to the version used to save the settings.

**Note:** Since firmware version 2.10, saved settings cannot be applied from a USB drive which contains saved settings from a unit running firmware version is 2.03 or earlier. In such a case, create the settings restoration USB drive again using the unit running firmware version 2.10 or later.

**1** Connect the USB drive with the saved settings to a USB port on the TeraStation.

**2** In Settings, click *Management*.

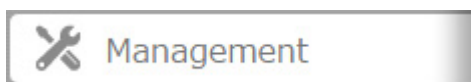

**3** Click  to the right of "Configuration Management".

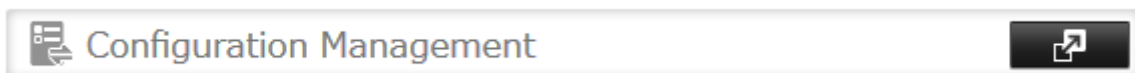

**4** From "Target USB Drive", select the USB drive that is connected to the USB port on the TeraStation.

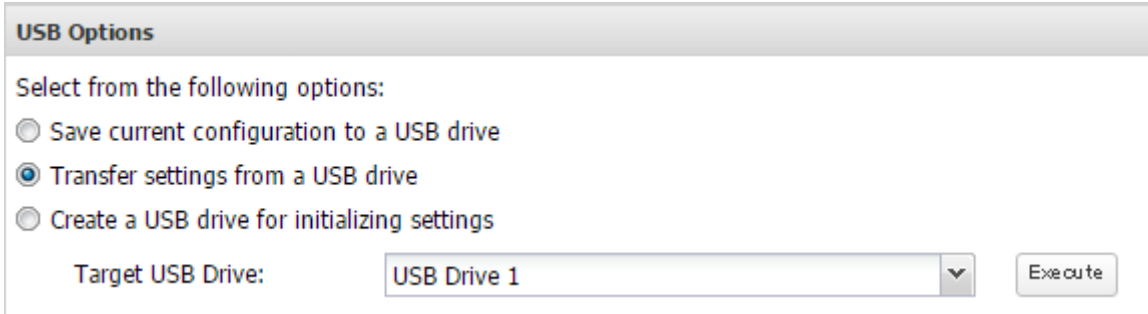

**USB Options**

Select from the following options:

- Save current configuration to a USB drive
- Transfer settings from a USB drive
- Create a USB drive for initializing settings

Target USB Drive:

**5** Select "Transfer settings from a USB drive", then click *Execute*.

**6** The "Confirm Operation" screen will open. Enter the confirmation number, then click *OK*. The TeraStation will apply the settings.

**7** When the "finished" message is displayed, applying settings is finished. Click *OK*.

---

## Transferring Another TeraStation's Settings

---

You can transfer saved settings from another series TeraStation to your TeraStation. The following settings can be transferred:

- Shared folders which are created from "File Sharing"- "Folder Setup"
- Access restrictions
- Users
- Groups

**Note:** This feature currently supports the following series of TeraStations as of August 2016. The latest compatibility information will be on the Buffalo website.

- TS-X series firmware version 1.58 or later
- TS3000 series
- TS4000 series
- TS5000 series
- TS3010 series
- TS5010 series

---

## Creating a Config File (.nas config)

---

### Procedure for TS-X Series

To transfer settings from TS-X series TeraStations, it will use the "NS-SHFT" software to create a config file. The NS-SHFT can be downloaded from the Buffalo website.

For the procedure on creating the config file, refer to the NS-SHFT user guide.

### Procedure for TeraStations Other Than TS-X Series

Follow the procedure below to create a config file on a TeraStation that is not a TS-X series.

**1** Refer to the user manual of the TeraStation that you want to transfer settings for saving settings to a USB drive.

- 2 Access the "usbdisk x" shared folder while connecting the USB drive to the TeraStation whose settings were saved in the previous step. The "x" in the folder name represents the USB port number you connected the drive to.
- 3 Copy and paste the .nas\_config file to the desired location on your computer.

## Transferring Settings

---

Follow the procedure below to transfer settings from another series TeraStation.

- 1 Before transferring access restrictions with Active Directory domain users, make sure the migration target TeraStations are joined to the same domain controller. To have the unit join the domain network, read and follow the procedure on the "Active Directory" section in chapter 3.  
If you didn't configure access restrictions with Active Directory domain users, skip to the next step.

- 2 In Settings, click *Management*.

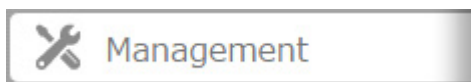

- 3 Click  to the right of "Configuration Management".

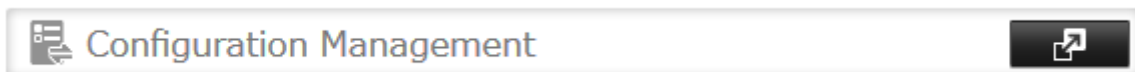

- 4 Click *Browse* and select the config file (.nas\_config) that was created with another TeraStation.  
If the config file was created with a password, enter it into the "Password" box.

**Configuration Migration**

Migrate another TeraStation's users, groups, shared folders, and access restriction settings. Select the config file (.nas\_config) that was saved on the other TeraStation.  
 Note: If the migration source TeraStation is configured with Active Directory, this TeraStation should also have the same configuration, or else migration will not work.

For detailed information about compatible products for migration or the procedure to save the config file, refer to to the [user manual](#).

Config File (.nas\_config):    
 Password:   
 (if needed)

- 5 Click *Import*.
- 6 The "Confirm Operation" screen will open. Enter the confirmation number, then click *OK*.
- 7 When the "finished" message is displayed, transferring settings is finished. Click *OK*.

**Notes:**

- If the migration target TeraStation contains shared folders, users, and groups that share the same name as the transferred settings, the existing settings will be overwritten.
- If the migration target TeraStations have already added some shared folders, users, and groups, the transferred settings may exceed the maximum number of allowed shared folders, users, or groups. After migration finishes, open Settings and verify that all settings were properly transferred.

---

## Restoring Factory Defaults

---

### Initializing from Settings

---

To initialize the TeraStation to its factory defaults from Settings, follow this procedure.

- 1 In Settings, click *Management*.



- 2 Click  to the right of "Restore/Erase".



- 3 Click *Initialize TeraStation*.

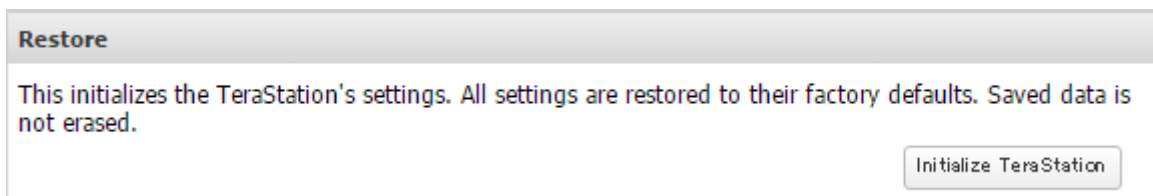

- 4 The "Confirm Operation" screen will open. Enter the confirmation number, then click *OK*. The TeraStation will be restored to its factory default settings.

- 5 When the "finished" message is displayed, restoring settings is finished. Click *OK*.

### Initializing with the USB Initialization Drive

---

An initialization drive will restore the settings on your TeraStation to their factory defaults. You can initialize them without logging in to Settings. Follow the procedure below to create an initialization drive.

#### Notes:

- Initializing settings with the USB drive is available for the same TeraStation unit that created the initialization drive.
- Normally, making and using the initialization drive will not affect data on the TeraStation. However, always back up your data regularly!
- This USB drive can be used to recover the system if your TeraStation doesn't boot at all. In this case, if the data partition is damaged, then all your data will be deleted by the recovery process.

### Creating an Initialization Drive

- 1 Insert a 1 GB or larger USB drive (not included) into a USB port on the TeraStation.

**Note:** All data on the USB drive will be erased!

- 2 In Settings, click *Management*.

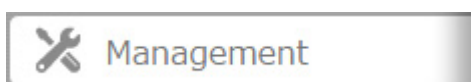

**3** Click  to the right of "Configuration Management".

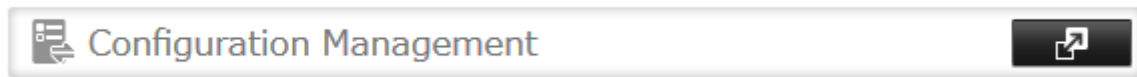

**4** From "Target USB Drive", select the USB drive that is connected to the USB port on the TeraStation.

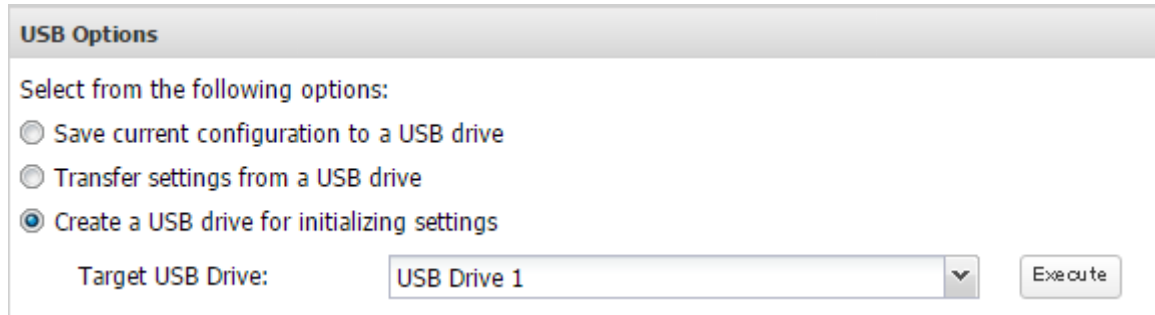

**5** Select "Create a USB drive for initializing settings", then click *Execute*.

**6** The "Confirm Operation" screen will open. Enter the confirmation number, then click *OK*. The TeraStation will create the initialization drive. This will take about a minute.

**7** When the "finished" message is displayed, the USB initialization drive is ready to use. Click *OK*.

## Initializing with the USB Drive

To initialize the settings on your TeraStation with the USB drive as created above, follow the procedure below.

**Note:** If using the initialization drive to initialize, the unit's current firmware version will be changed to the version used to create the initialization drive.

- 1** Turn off the TeraStation by pressing and holding the power button for 3 seconds.
- 2** Insert the USB drive into a USB port on the TeraStation. Make sure that no other USB drives are currently connected to the TeraStation.
- 3** Power on the TeraStation while holding down the function button.
- 4** When the I41 message appears on the LCD panel, press the function button.
- 5** It will take several minutes for initializing the settings. The TeraStation will restart when it's finished.

Dismount the USB drive before unplugging it. See the "Dismounting Drives" section in chapter 4 for the procedure on dismounting drives.

---

## Resetting the Administrator Password

---

If you forget the admin username or password and cannot log in to Settings, or wrong network settings are configured and Settings is inaccessible, initialize these settings by holding down the init button (refer to the TeraStation diagram in chapter 1) on the front panel for three seconds. Normally this will reset the admin username and password, network configuration, SSL, and security port settings to their factory default values.

This button can be disabled in Settings; to do so, navigate to *Management - Restore/Eraser - Edit* under "Init Button Settings", then select "Keep current admin username and password" and click *OK*.

---

# Logs

---

## Displaying TeraStation's Logs

---

Follow the procedure to check the TeraStation's logs.

- 1 In Settings, click *Management*.



- 2 Click  to the right of "Logs".

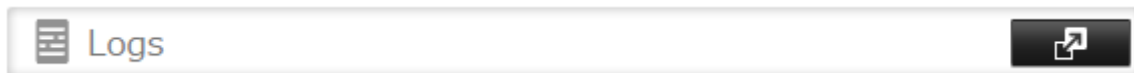

- 3 Select a log to view.

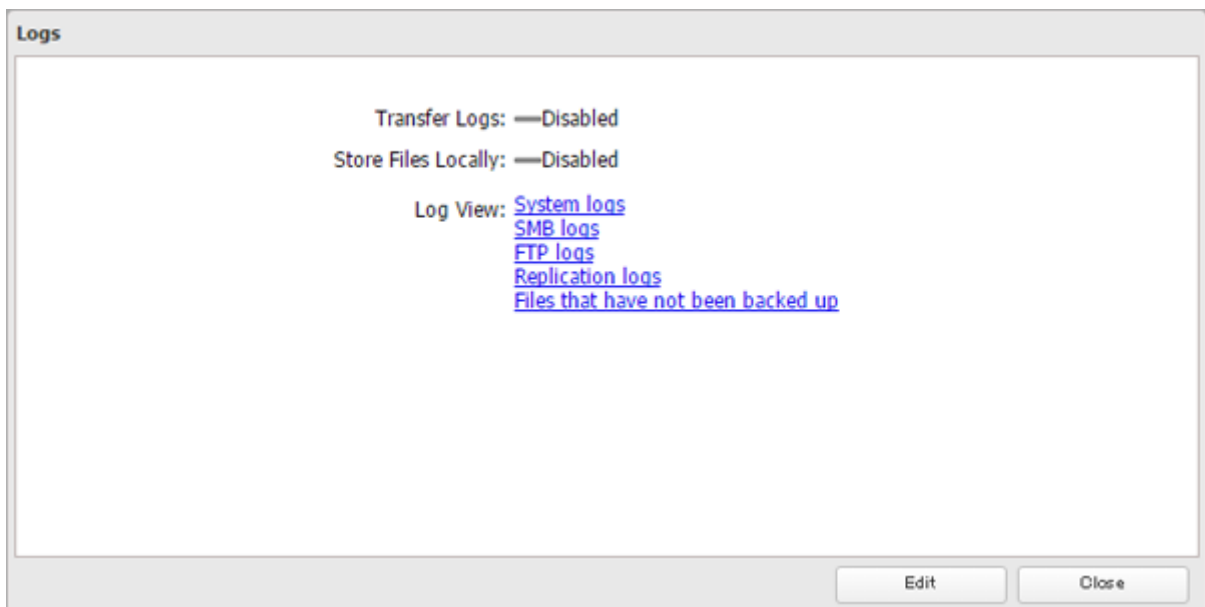

The file operation log stores file operations performed on the internal drives. File operations on USB drives are not logged.

**Note:** All logs are encoded in UTF-8 format. To show them correctly, change the software encoding to "UTF-8".

## Transferring Logs to the Syslog Server

---

- 1 In Settings, click *Management*.

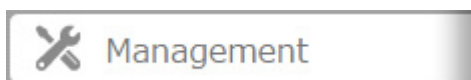

- 2 Click  to the right of "Logs".



- 3 Click *Edit*.

#### 4 Enable "Syslog Transfer".

The screenshot shows a 'Logs' configuration window. At the top right, there is a red asterisk and the word 'Required' next to a help icon. The 'Syslog Transfer' section has a radio button for 'Enable' selected. Below it is a text box for 'Syslog Server IP Address \*'. Underneath that, there are two checkboxes: 'System logs' and 'SMB logs', both of which are unchecked. Below these is a radio button for 'Disable'. The 'Share Link to Logs' section has a radio button for 'Enable' selected. Below it is a text box for 'Target Shared Folder \*' with a 'Browse' button to its right. At the bottom right of the window are 'OK' and 'Cancel' buttons.

5 Enter the IP address of the syslog server where you want to transfer the logs to.

6 Select the type of log that you want to transfer from "Logs to Transfer".

7 Click *OK*.

## Creating a Link to the Logs in the Shared Folder

---

1 In Settings, click *Management*.

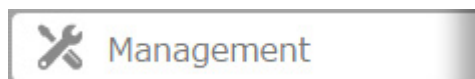

2 Click  to the right of "Logs".



3 Click *Edit*.

**4** Enable "Share Link to Logs".

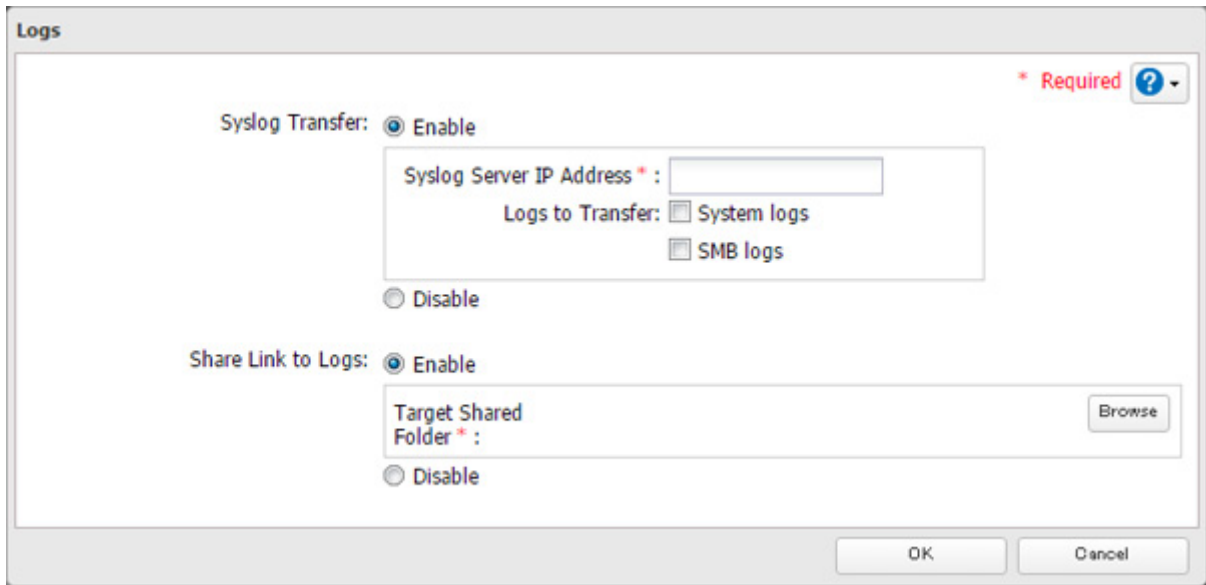

**5** Click *Browse* and select the shared folder where the link will be created in "Target Shared Folder". Click *OK*.

**6** Click *OK*.

Under the selected shared folder, a folder named "system\_log" will now contain the logs.

---

## Updating the Firmware

---

If a new firmware is available, a message is displayed when the TeraStation boots. You can update the firmware either manually or automatically.

**Notes:**

- If all drives and RAID arrays on the TeraStation have LVM enabled but no LVM volumes have been created, you will not be able to update the firmware from Settings.
- Settings is not available while the firmware is updating. Don't try to access Settings from another computer until the update is complete.

## Updating Manually

---

**1** In Settings, click *Management*.

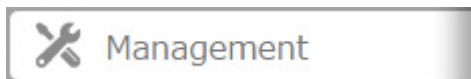

**2** Click  to the right of "Update".



**3** Click *Install Update*.

You can also download the latest firmware from the Buffalo website.

## Updating Automatically

---

**1** In Settings, click *Management*.



**2** Click  to the right of "Update".



**3** Click *Edit*.

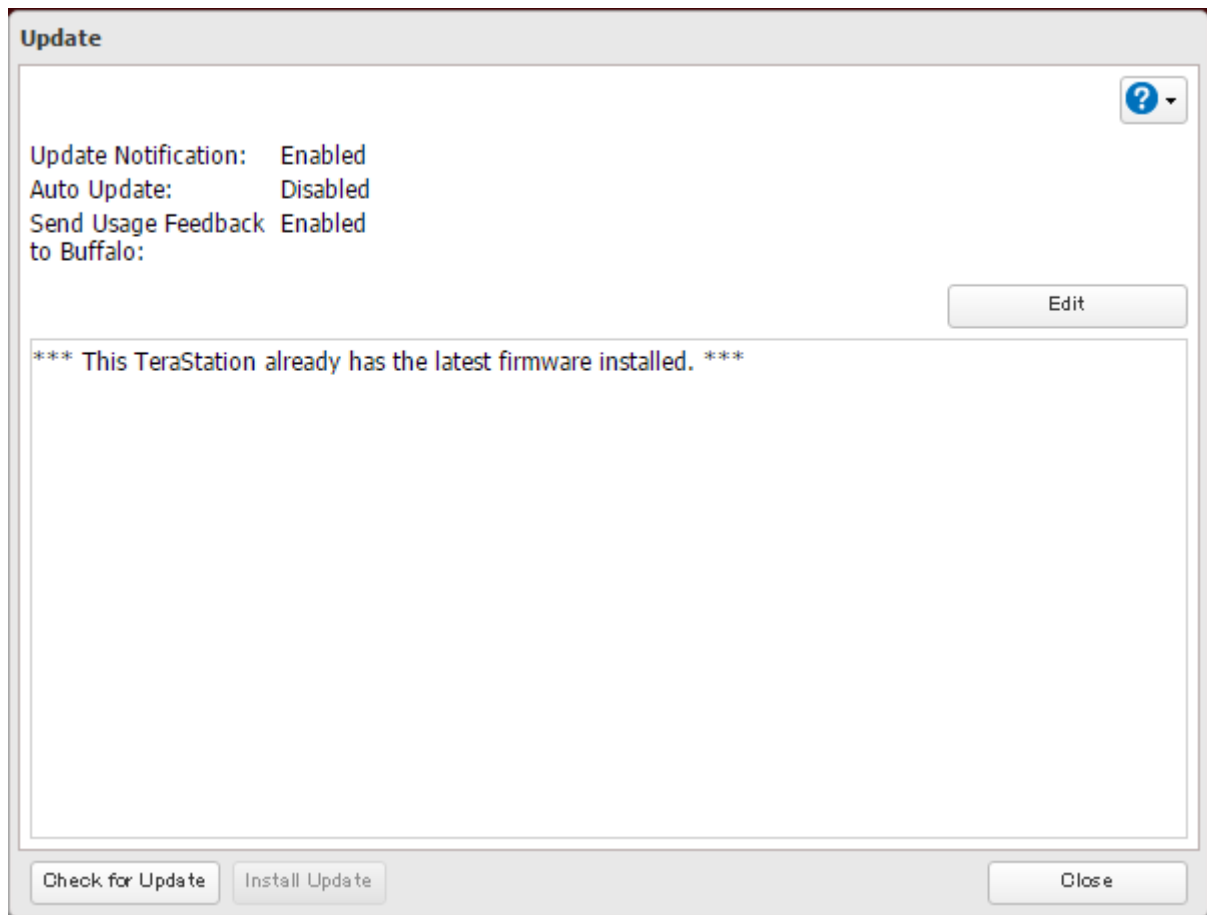

- 4 Select "Update the firmware automatically" and click *OK*.

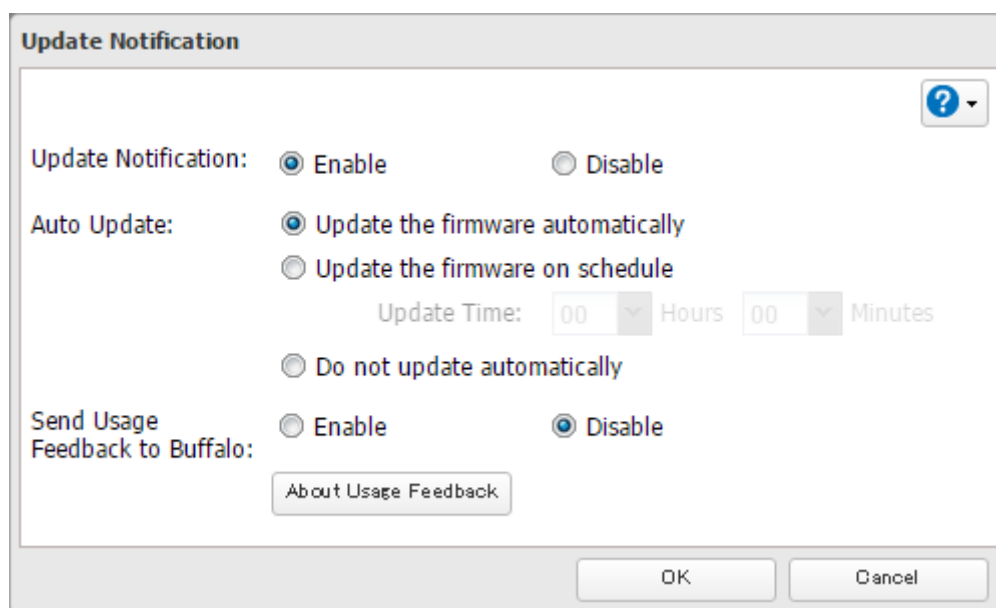

Alternately, you may choose to schedule updates for a specific time of day.

---

## Sending Usage Feedback

---

For further firmware update or product usability improvement, Buffalo may ask you to send your usage and environment information, such as number of shared folders and client computers, and/or S.M.A.R.T. information. The collected information will only be used for improving future firmware stability and product development and no other purpose.

If you don't want to send this information to us, follow the procedure below to disable the usage feedback delivery.

- 1 In Settings, click *Management*.



- 2 Click  to the right of "Update".



**3** Click *Edit*.

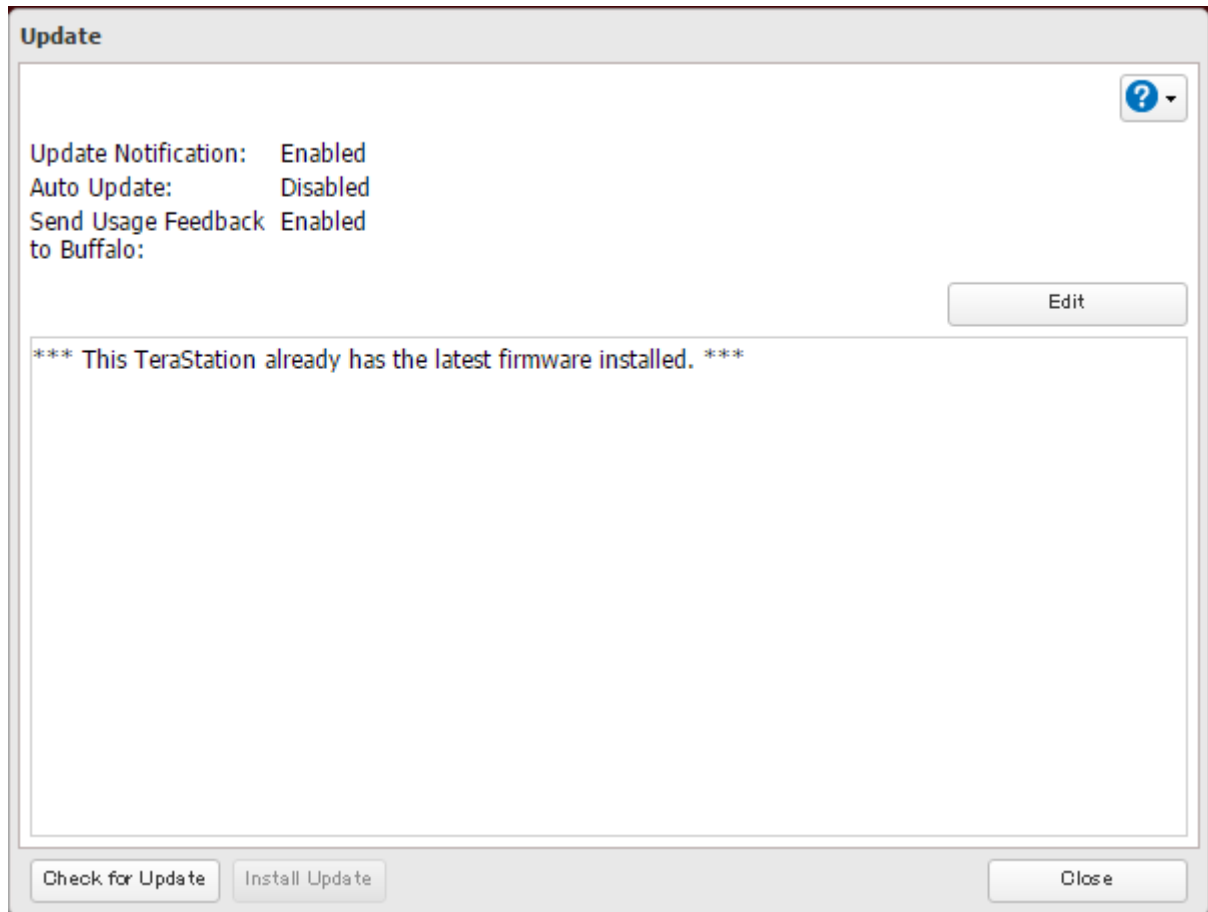

**4** Disable "Send Usage Feedback to Buffalo".

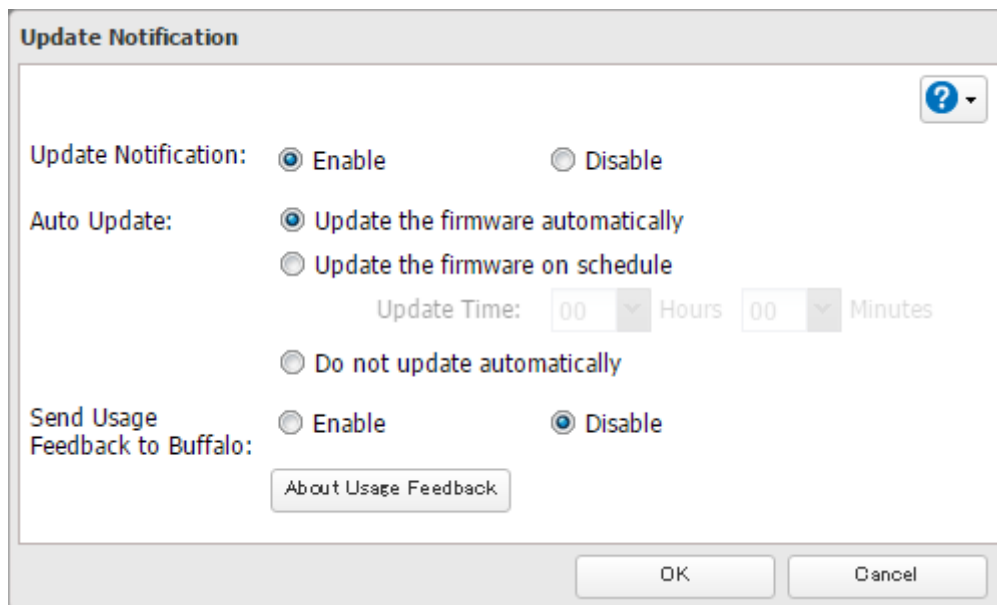

---

## Name, Date, Time, and Language

---

Configure the TeraStation's hostname, date, time, and language as shown below.

**Note:** If the TeraStation is being used as an iSCSI drive, to change the settings, navigate to *Storage - iSCSI* in Settings and move the iSCSI switch to the off position temporarily before changing settings.

**1** In Settings, click *Management*.



**2** Click  to the right of "Name/Time/Language".



**3** Click *Edit*.

**4** Click the *Name* tab, then configure the TeraStation's name and description.

A dialog box titled "Name/Time/Language" with a grey border. In the top right corner, there is a red asterisk followed by the word "Required" and a blue question mark icon. Below the title bar is a tabbed interface with four tabs: "Name", "Time", "Language", and "Management Information". The "Name" tab is selected. Under the "Name" tab, there are two text input fields. The first is labeled "Name \* :" and contains the text "TS5410D08C". The second is labeled "Description:" and contains the text "TeraStation". At the bottom right of the dialog box are two buttons: "OK" and "Cancel".

**5** Click the *Time* tab. Enable the NTP server and select the "Use Default NTP Server" checkbox.

Click *Use Local Date/Time* to use your computer's time settings for the TeraStation.

The screenshot shows a configuration window titled "Name/Time/Language". It has four tabs: "Name", "Time", "Language", and "Management Information". The "Time" tab is selected. In the top right corner, there is a red asterisk and the word "Required" next to a help icon. Below the tabs, the "Date/Time Source:" section has two radio buttons: "Enable" (selected) and "Disable". Under "Enable", there is a text field for "NTP IP Address \*" containing "ntp.jst.mfeed.ad.jp", a checked checkbox for "Use default NTP server", and a dropdown menu for "NTP Synchronization Frequency" set to "Daily". The "Disable" section is dimmed and contains a "Date \*" field with "10/25/2016" and a "Time \*" field with "15 : 16 : 58". A "Use Local Date/Time" button is located to the right of the time field. Below this is the "Time Zone:" section with a dropdown menu showing "(UTC-06:00) Central Time (US & Canada)". At the bottom right are "OK" and "Cancel" buttons.

By default, the TeraStation adjusts its clock automatically by using a default NTP server. This NTP server belongs to Internet Multi Feed Inc. For more information, visit <http://www.jst.mfeed.ad.jp>.

To use a different NTP server, select *Name/Time/Language* from *Management*. Click *Time*, then *Edit*. Clear the "Use Default NTP Server" checkbox and enter a new NTP IP address. Click *OK*.

If an NTP server is specified by name instead of IP address, make sure that a DNS server is configured for the TeraStation.

**Note:** The internal clocks of the TeraStation and other devices on your network may run at slightly different speeds. Over a long period of time your network devices may show somewhat different times, which can cause network problems. If clocks on your network vary by more than 5 minutes it may cause unexpected behavior. For best results, keep all clocks on the network set to the same time by adjusting them regularly, or use an NTP server to correct them all automatically.

- 6 Click the *Language* tab. Select the language to be used and click *OK*.

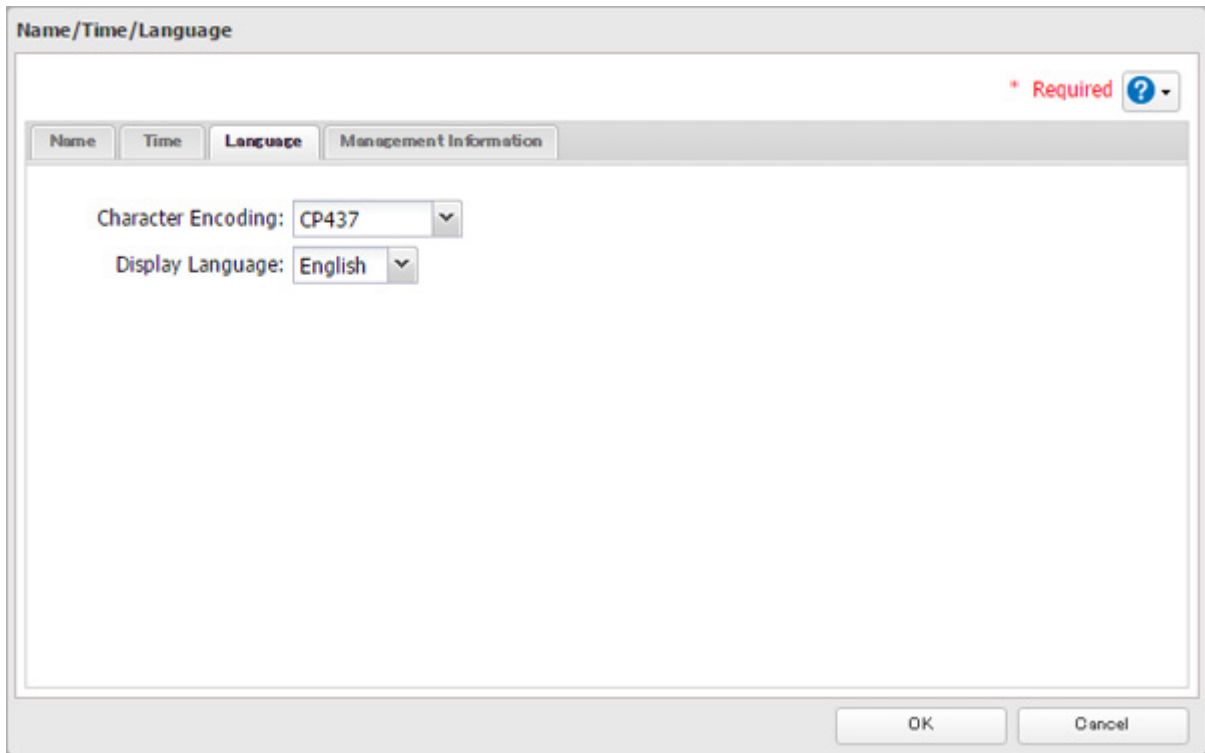

**Note:** This tab changes the language used by the TeraStation for email notifications and other functions. To change the language displayed in Settings, go to Advanced Settings or Easy Admin and click *Language* from the menu bar. Choose your desired language from the drop-down list.

---

## Beep Alerts

---

You can set the TeraStation to beep if certain errors occur.

- 1 In Settings, click *Management*.

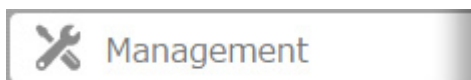

- 2 Click  to the right of "Notifications".

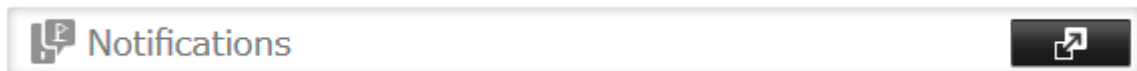

- 3 Click *Edit*.

- 4 Click the *Alert Sound* tab.

**5** Select the triggers to make the alert beep, then click *OK*.

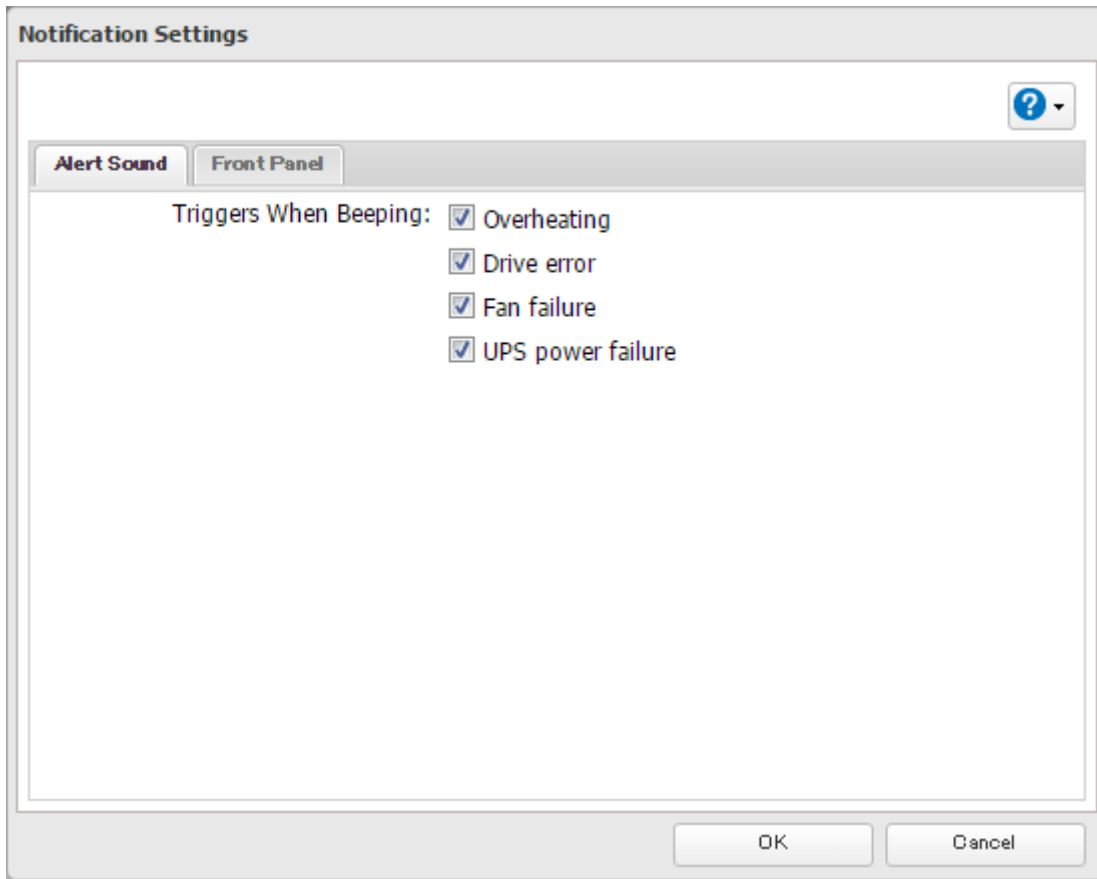

---

## LCD and LEDs

---

You may configure the LEDs and LCD on the front of the TeraStation.

**1** In Settings, click *Management*.



**2** Click  to the right of "Notifications".

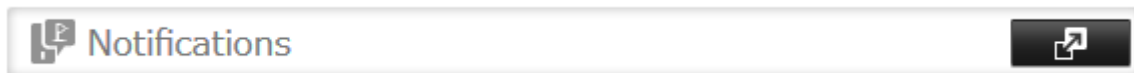

**3** Click *Edit*.

**4** Click the *Front Panel* tab.

**5** Configure your settings, then click *OK*.

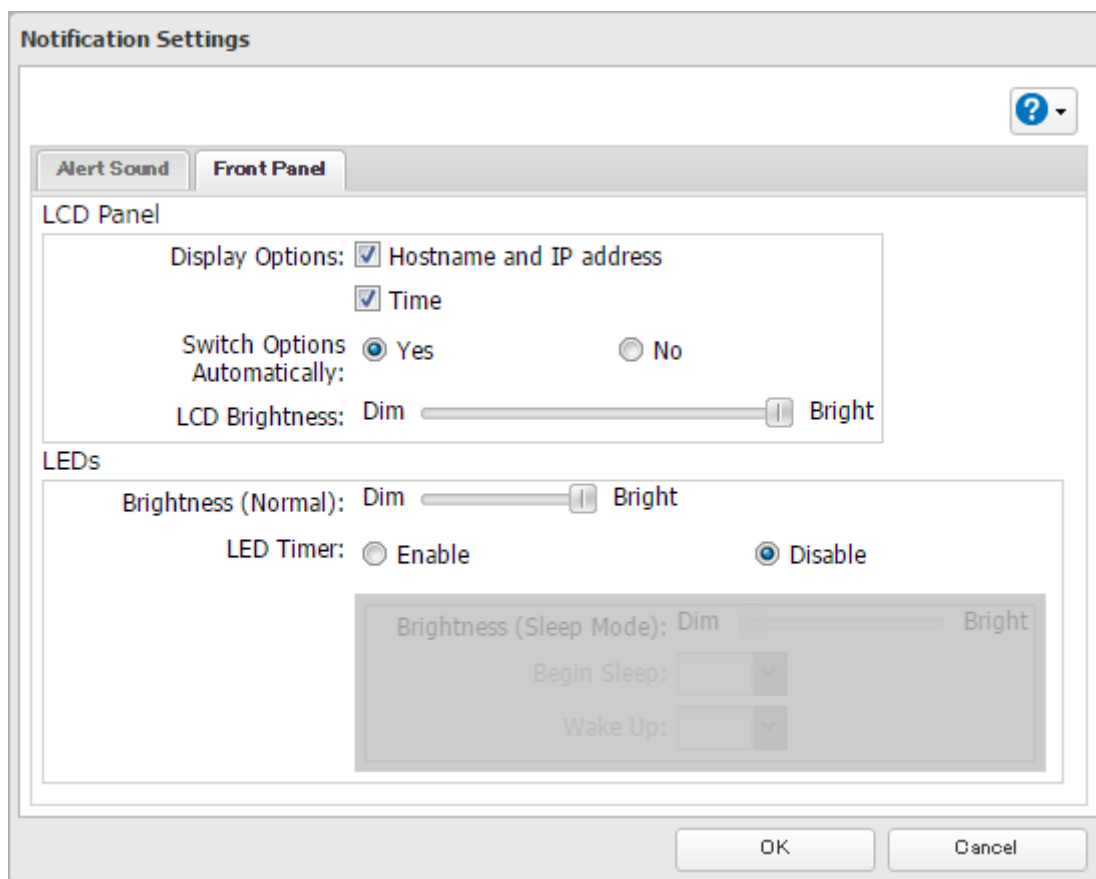

---

## Proxy Server

---

If you locate the TeraStation on the network that passes through a proxy server, configuring the proxy server settings is recommended. Unless you configure the proxy settings, firmware updates from Settings will not work. To configure the settings, follow the procedure below.

**1** In Settings, click *Network*.



**2** Click  to the right of "Proxy Server".



**3** Enable "Proxy Server".

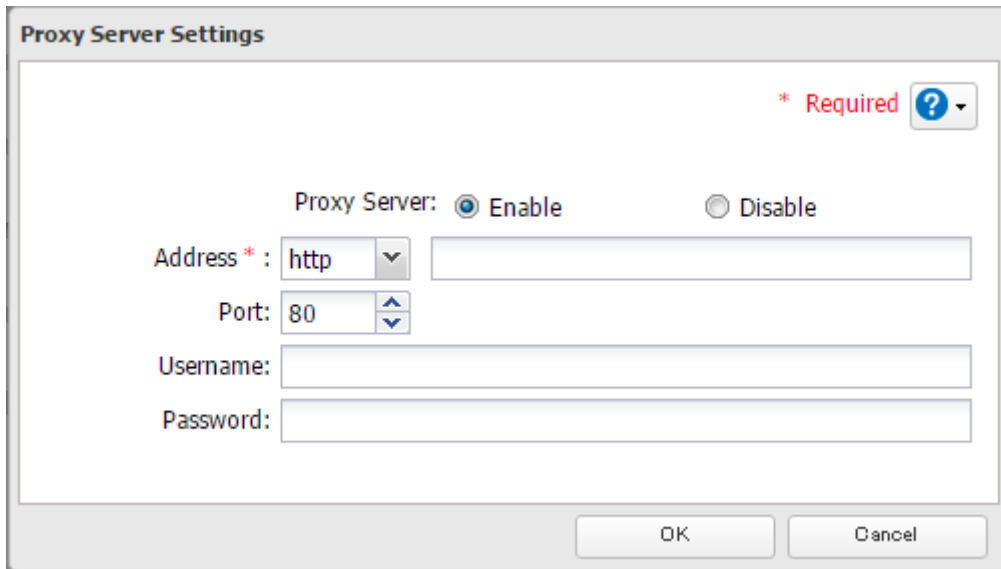

The image shows a "Proxy Server Settings" dialog box. At the top right, there is a red asterisk followed by the word "Required" and a help icon (a question mark in a blue circle). Below this, the "Proxy Server:" label is followed by two radio buttons: "Enable" (which is selected) and "Disable". Underneath, there are four input fields: "Address\*" with a dropdown menu currently showing "http" and an empty text box; "Port:" with a spinner box showing "80"; "Username:" with an empty text box; and "Password:" with an empty text box. At the bottom of the dialog, there are two buttons: "OK" and "Cancel".

**4** Enter the proxy server IP address or hostname, port number, username and password, then click *OK*.

Once you configure the proxy server settings, you may use the settings for other web services such as cloud storage or Dropbox Sync by selecting the "Configured settings" option on each settings page.

---

## Jumbo Frames

---

If your other network devices support jumbo frames, you may be able to increase network performance.

**1** In Settings, click *Network*.

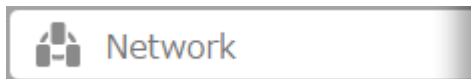

**2** Click  to the right of "IP Address".



### 3 Click *Edit*.

**IP Address List**

Interface	Type	DHCP	IP Address	Subnet Mask	MTU Size	More Details
LAN Port 1	1 GbE	✓	192.168.10.10	255.255.255.0	1500 bytes	▶
LAN Port 2	1 GbE	✓	—	—	1500 bytes	▶
LAN Port 3	10 GbE	✓	—	—	1500 bytes	▶

Wake-on-LAN: Disabled  
Gateway Owner: Automatically assigned (LAN port 1)  
Default Gateway Address: 192.168.10.1  
DNS Owner: Automatically assigned  
Primary DNS Server: 192.168.10.1  
Secondary DNS Server: Not assigned

Allowed Protocols for Each Port    Port Trunking    Edit    Close

4 Select or enter the desired MTU size and click **OK**.

**IP Address List** ?

Interface	DHCP	IP Address	Subnet Mask	MTU Size
LAN Port 1	<input checked="" type="checkbox"/>	192.168.10.10	255.255.255.0	1500
LAN Port 2	<input checked="" type="checkbox"/>		255.255.255.0	1500
LAN Port 3	<input checked="" type="checkbox"/>		255.255.255.0	1500

MTU sizes of 1500–9216 bytes are supported. The stated size doesn't include 14 bytes of header and 4 bytes of FCS. The default MTU size is 1500 bytes. MTU sizes of 1501 bytes or more are considered jumbo frames.

Wake-on-LAN:  Enable  
 Disable

















Gateway Owner: Assign automatically

Default Gateway Address: 192.168.10.1

DNS Owner: Assign automatically

Primary DNS Server: 192.168.10.1

Secondary DNS Server:

Connection			Transmission	
 Jumbo Frame	 Jumbo Frame Compatible Switch	 Jumbo Frame Compatible PC		Transfer data in jumbo frames.
 Jumbo Frame	 Jumbo Frame Compatible Switch	 Jumbo Frame <b>Incompatible</b> PC		Transfer data not using jumbo frames.
 Jumbo Frame	 Jumbo Frame <b>Incompatible</b> Switch	 Jumbo Frame <b>Incompatible</b> PC		Transfer data not using jumbo frames.
 Jumbo Frame	 Jumbo Frame <b>Incompatible</b> Switch	 Jumbo Frame Compatible PC		Any data cannot be transferred.

**Note:** Make sure the TeraStation's MTU size is smaller than the hub or router's. Larger MTU sizes may not transfer the data to the TeraStation correctly.

## Changing the IP Address

Normally, the TeraStation's IP address is set automatically from a DHCP server on your network. If you prefer, you can set it manually. An easy way to do this is to change it from NAS Navigator2 running on a computer connected to the same router (subnet) as the TeraStation. The procedure to change the IP address in Settings is below.

**Note:** If the TeraStation is being used as an iSCSI drive, to change the settings, navigate to *Storage - iSCSI* in Settings and move the iSCSI switch to the off temporarily before changing network settings.

- 1 In Settings, click *Network*.

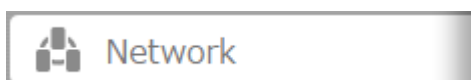

- 2 Click  to the right of "IP Address".



**3** Click *Edit*.

**IP Address List**

Interface	Type	DHCP	IP Address	Subnet Mask	MTU Size	More Details
LAN Port 1	1 GbE	<input checked="" type="checkbox"/>	192.168.10.10	255.255.255.0	1500 bytes	
LAN Port 2	1 GbE	<input checked="" type="checkbox"/>	—	—	1500 bytes	
LAN Port 3	10 GbE	<input checked="" type="checkbox"/>	—	—	1500 bytes	

Wake-on-LAN: Disabled  
Gateway Owner: Automatically assigned (LAN port 1)  
Default Gateway Address: 192.168.10.1  
DNS Owner: Automatically assigned  
Primary DNS Server: 192.168.10.1  
Secondary DNS Server: Not assigned

Allowed Protocols for Each Port    Port Trunking    Edit    Close

**4** Clear the "DHCP" checkbox and enter the desired IP address and its subnet mask.

**IP Address List**

Interface	DHCP	IP Address	Subnet Mask	MTU Size
LAN Port 1	<input type="checkbox"/>	192.168.10.75	255.255.255.0	1500
LAN Port 2	<input checked="" type="checkbox"/>		255.255.255.0	1500
LAN Port 3	<input checked="" type="checkbox"/>		255.255.255.0	1500

MTU sizes of 1500–9216 bytes are supported. The stated size doesn't include 14 bytes of header and 4 bytes of FCS. The default MTU size is 1500 bytes. MTU sizes of 1501 bytes or more are considered jumbo frames.

Wake-on-LAN:  Enable  
 Disable

Gateway Owner: User (static)  
Default Gateway Address: 192.168.10.1  
DNS Owner: User (static)  
Primary DNS Server: 192.168.10.1  
Secondary DNS Server:

OK    Cancel

**5** Select "User (static)" for both "Gateway Owner" and "DNS Owner" options from the drop-down list, then enter the desired default gateway address and DNS server addresses.

**6** Click *OK*.

**Notes:**

- Only one default gateway and DNS address can be configured for all LAN ports. Different network addresses cannot be assigned to the LAN ports.
- Do not set the IP address of the same segment for all LAN ports. This may cause unstable network communication.
- The following IP addresses are reserved and should not be used. If you configure one of them by accident, initialize all settings using the init button on the TeraStation.
  - Local loopback address: 127.0.0.1, 255.255.255.0
  - Network address: 0.0.0.0, 255.255.255.0
  - Broadcast address: 255.255.255.255, 255.255.255.0
  - The IP address range from 224.0.0.0 to 255.255.255.255

---

## Boot Authentication

---

Boot authentication allows you to authenticate the TeraStation while it's booting, and also prevent the TeraStation from being used in an unauthorized or unexpected manner, such as in cases of theft.

If authentication fails, the TeraStation will remain on, but all functions and services are stopped. Users will not be able to log in to Settings to make changes or access any shares.

### Note Before Use

---

- To use boot authentication, a Windows PC is necessary to serve as the authentication server.
- When activating boot authentication, the drives on the TeraStation will be formatted and all data on the drives will be erased. Back up any important data to another device. Even though the data is deleted, the RAID array will be kept as is.
- Assigning the TeraStation a fixed IP address is recommended for boot authentication.
- When boot authentication settings finish, export the configuration file for backup. Refer to the "Exporting Managed TeraStations to a File" section in the Boot Authentication Tool help for the procedure.
- Boot authentication cannot be enabled if any of the following functions is enabled: drive encryption, LVM, iSCSI, and failover. Conversely, these functions cannot be enabled while boot authentication is enabled.

### Important Notice

---

This feature was developed with the intention of preventing critical data leakage by rendering the TeraStation unusable in cases of misoperation or missing important setting files. Before configuring boot authentication, back up the data on the TeraStation by referring to the "Backup" section in chapter 5 and create a settings initialization drive by referring to the "Creating an Initialization Drive" subsection above. With these preparations, a TeraStation that is unusable may be initialized and reverted to a usable state.

If any of the situations below occur, the TeraStation will stop booting and become inaccessible.

- The TeraStation is unable to communicate with the authentication server due to the server crashing or it being on another network.
- The TeraStation unit has been deleted from Boot Authentication Tool or the Boot Authentication Tool database has been erased.
- Security level is configured to "High" and the wrong passcode is entered 3 times.

## Setting Up the Authentication Server on a Windows PC

---

To set up the authentication server, follow the procedure below. The authentication server must be on the local network or VPN.

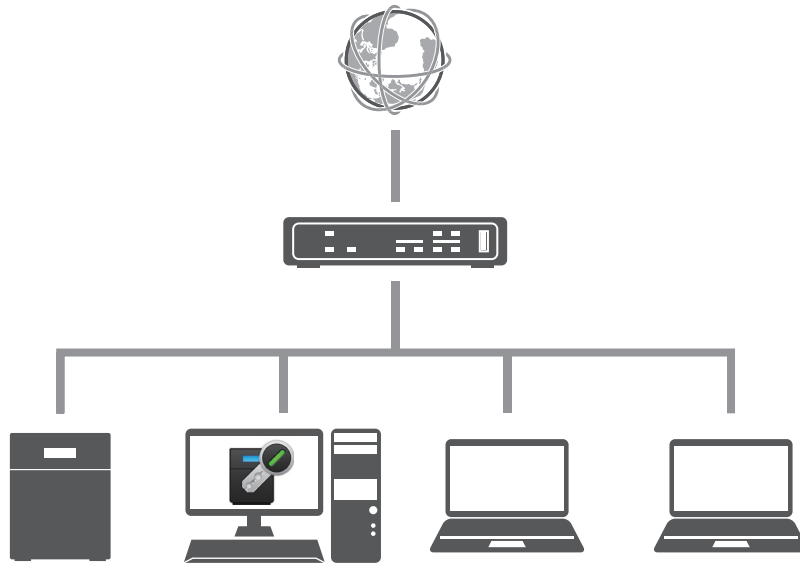

**Note:** For proper operation, make sure that the TeraStation and the authentication server are on a network with only one router. If there are two or more routers on the network, the authentication server may not acquire the correct TeraStation status. For example, if the TeraStation's IP address has been changed, its status does not change to "Warning".

- 1** Download the application for the authentication server, "Boot Authentication Tool", from the Buffalo website and install it onto the Windows PC.
- 2** Register the specific port number that is used on the application as a firewall exception rule. Navigate to *Control Panel - System and Security - Windows Firewall* on the authentication server.
- 3** Click *Advanced settings*.
- 4** Right-click *Inbound Rules* and click *New Rule*.
- 5** Select "Port" and click *Next*.
- 6** Select "TCP", enter the port number that is used on the application to the right of "Specific local ports", and click *Next*. The default port number on the application is "7010". The port number can be confirmed in the "Options" tab of the application.
- 7** Click *Next* twice.
- 8** Enter a desired name for the setting and click *Finish* to complete.

## Configuring Boot Authentication on the TeraStation

---

- 1** In Settings, click *Management*.



2 Click  to the right of "Boot Authentication".

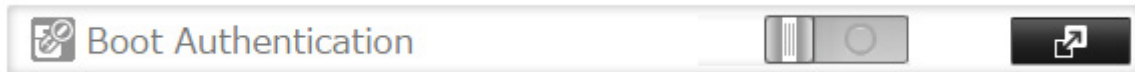

3 Click *Edit*.

4 Enter the authentication server's IP address or hostname and port number, specify the security level and communication time settings, then click *Activate*.

**Boot Authentication Settings**

\* Required 

Authentication Server Address \* :

Port Number \* :

Security Level \* :  Medium  High

Medium: If the TeraStation cannot communicate with the authentication server and the passcode was entered incorrectly, the original passcode will remain valid.

High: If the TeraStation cannot communicate with the authentication server and the passcode was entered incorrectly 3 times, the TeraStation will become unusable.

Notes from Settings:

Server Communication Time \* :  Hours  Minutes

5 The drive formatting process will start. Click Yes.

6 The "Confirm Operation" screen will open. Enter the confirmation number, then click *OK*.

- 7 The format will begin. Wait until it finishes. When the formatting finishes and the TeraStation is added to Boot Authentication Tool, boot authentication setting is completed.

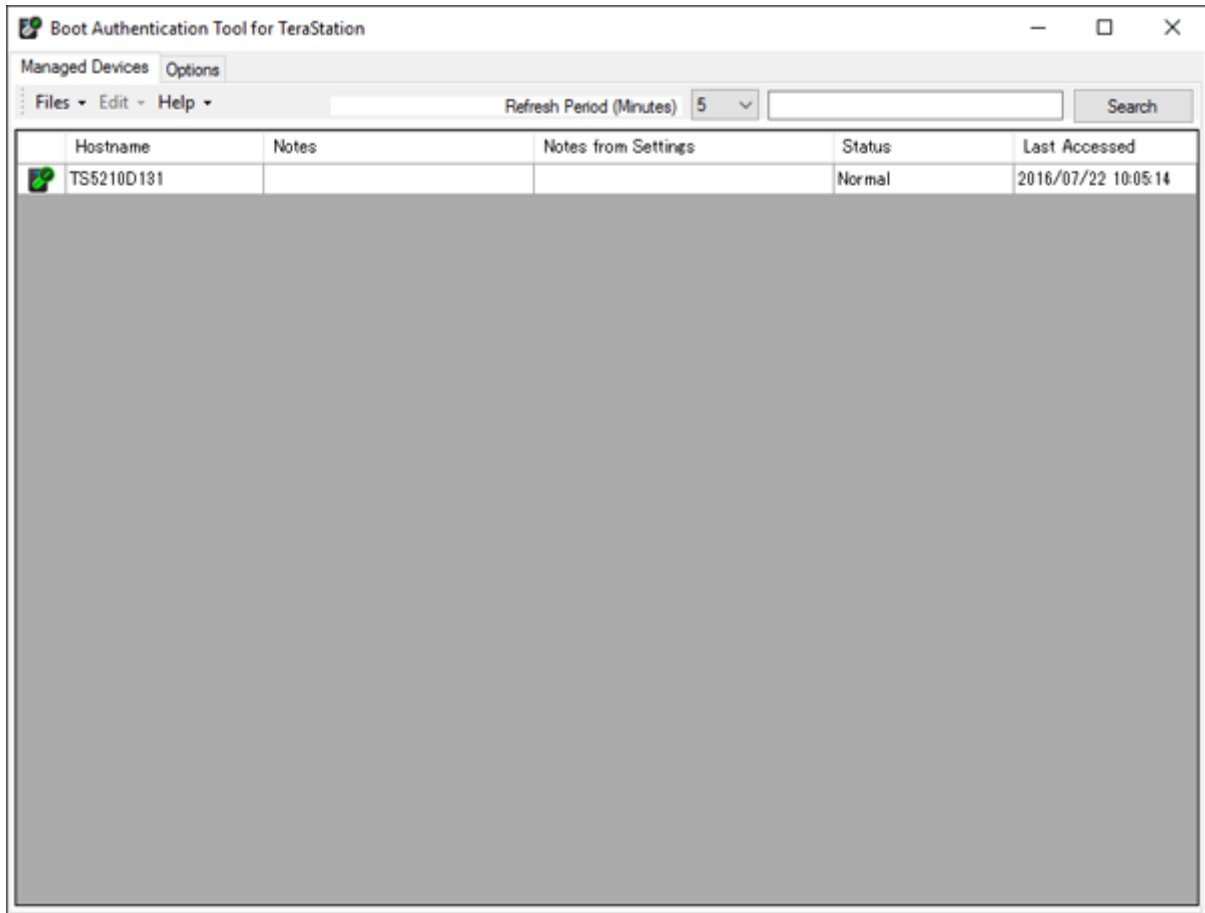

**Note:** To activate, deactivate, or change the boot authentication settings, the TeraStation must be communicating with the authentication server.

## If the TeraStation Cannot Be Accessed

If the TeraStation cannot communicate with the authentication server or vice versa, such as in a case of network failure, the TeraStation will not be accessible. If the TeraStation is not accessible, manually authenticate the TeraStation by following the procedure below.

**Note:** The procedure defines an "authentication server administrator" as someone who manages the authentication server using Boot Authentication Tool, and a "user" as one attempting to access the TeraStation from a remote location.

- 1 When the user tries to access the TeraStation's Settings and the TeraStation is not available, the screen below will be displayed. Have the user forward the decryption key to the authentication server administrator.

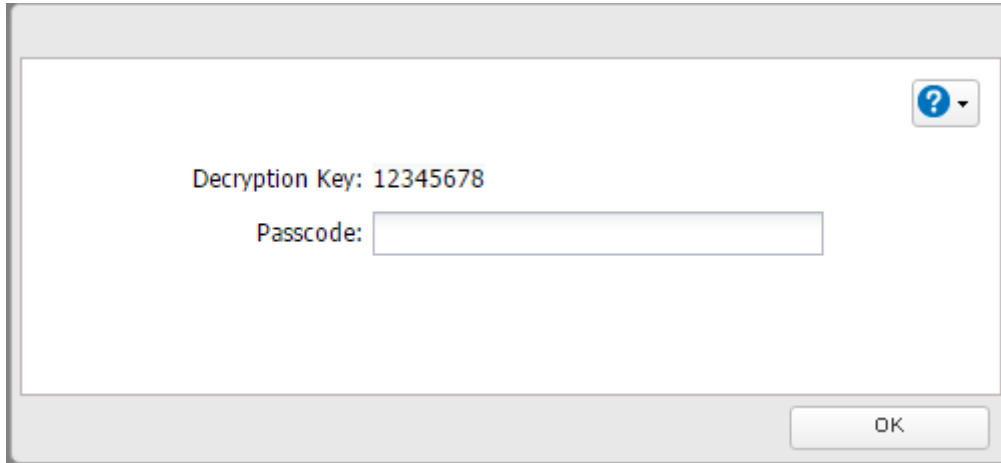

- 2 Open Boot Authentication Tool on the authentication server.
- 3 From Boot Authentication Tool, right-click on the target TeraStation from the list and click *Decrypt Passcode*.
- 4 Enter the decryption key received from the user and click *Decrypt*.

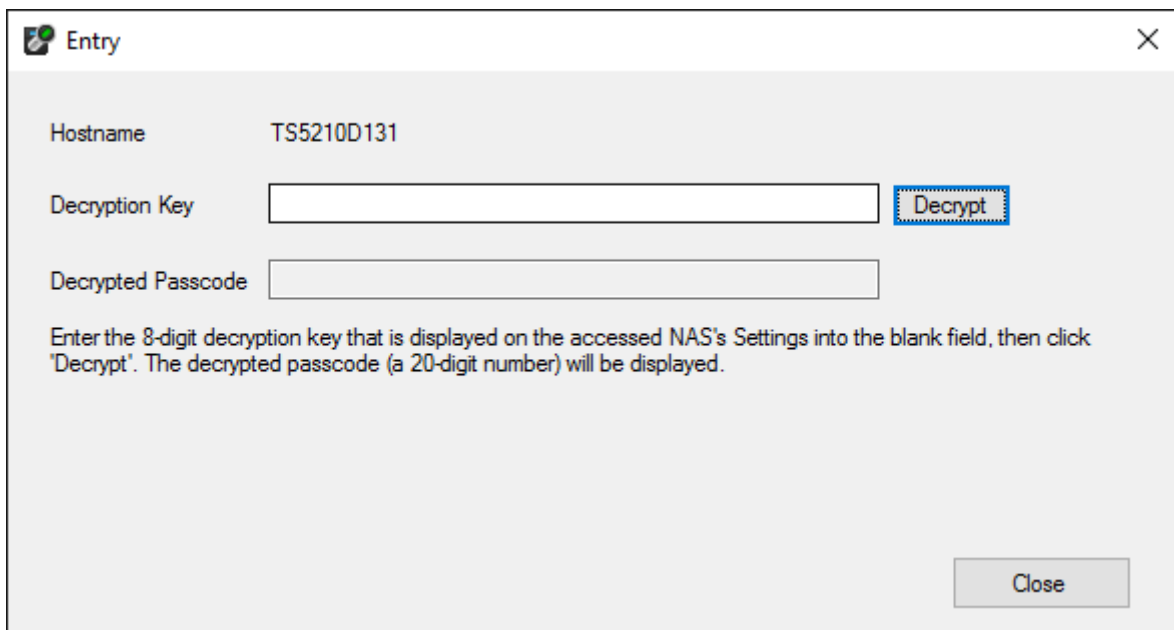

**5** The decrypted 20-digit passcode will be displayed. Send the passcode to the user.

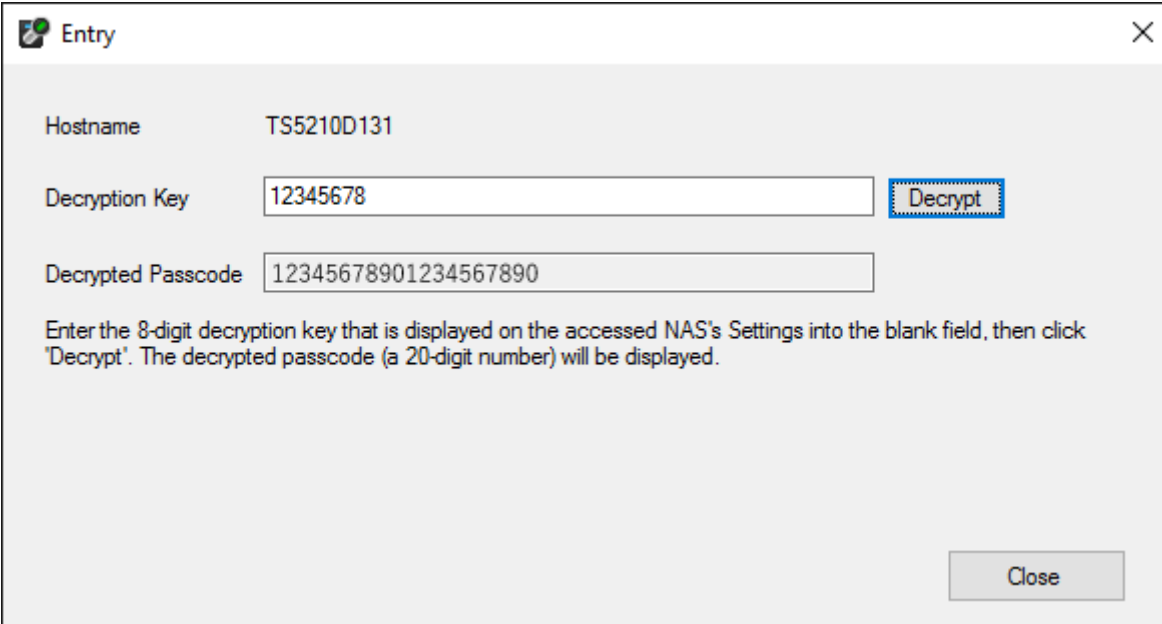

The screenshot shows a dialog box titled "Entry" with a close button (X) in the top right corner. It contains the following fields and controls:

- Hostname: TS5210D131
- Decryption Key: 12345678 (with a "Decrypt" button to its right)
- Decrypted Passcode: 12345678901234567890

Below the fields, there is a text instruction: "Enter the 8-digit decryption key that is displayed on the accessed NAS's Settings into the blank field, then click 'Decrypt'. The decrypted passcode (a 20-digit number) will be displayed." At the bottom right, there is a "Close" button.

**6** The user can then enter the 20-digit passcode into Settings and click *OK*.

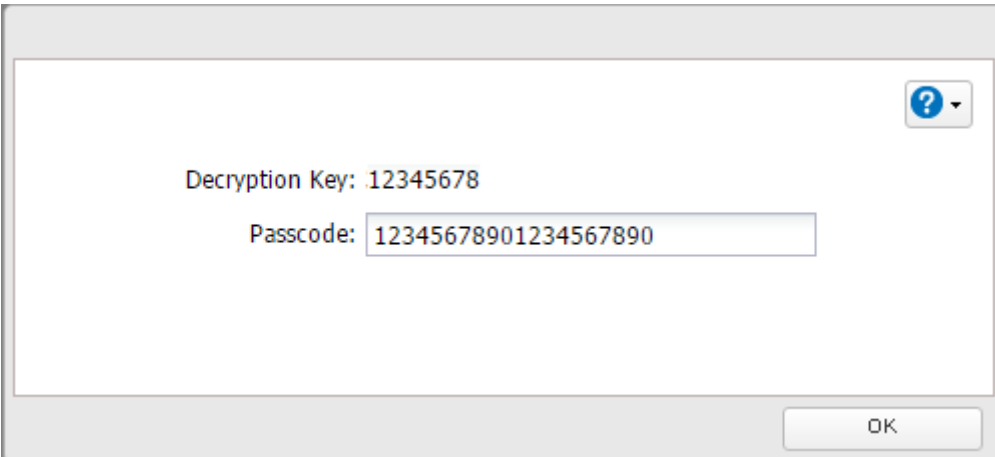

The screenshot shows a dialog box with a help icon (question mark in a blue circle) in the top right corner. It contains the following fields and controls:

- Decryption Key: 12345678
- Passcode: 12345678901234567890

At the bottom right, there is an "OK" button.

If the passcode is authenticated, the TeraStation will become available. The user can click *OK* to log in to Settings.

# Chapter 8 Replacing Drives

## LEDs

Drives in the TeraStation show a green status LED during normal operation. If a drive fails, its error LED will glow red.

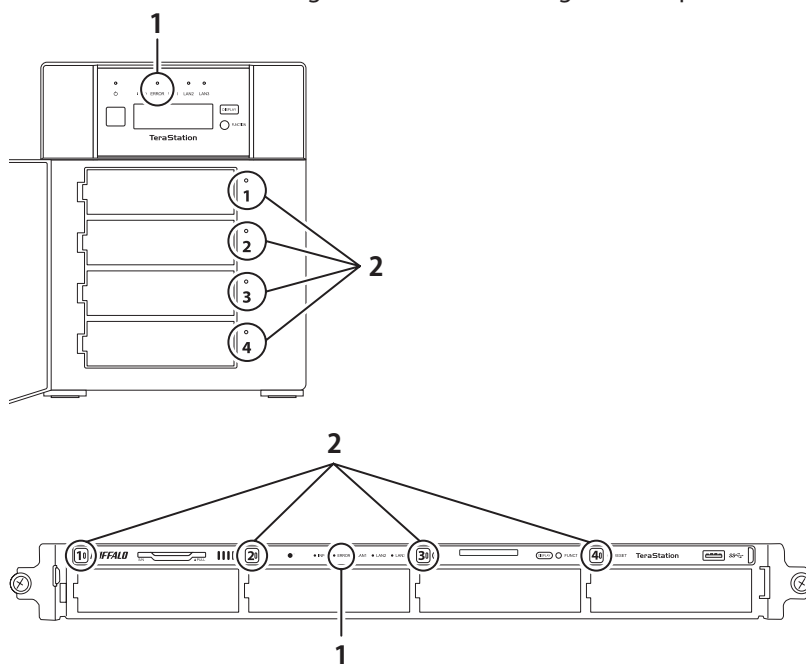

### 1 Error LED

Glowes red if a drive has failed.

### 2 Status LEDs

The failed drive's status LED will be glowing a steady red. A drive with a red status LED is ready to hot-swap.

#### Notes:

- Do not unplug a drive whose status LED is green instead of red. Dismount it first or shut down the TeraStation before swapping a working drive. If you remove the drive without properly dismounting it, data may be lost or the TeraStation may malfunction.
- For the replacement drive, use a Buffalo OP-HDN series drive for TS5010DN series TeraStations. The new drive should be the same size or larger. If a larger drive is used, the extra space will not be usable in a RAID array.
- To avoid damaging the TeraStation with static electricity, ground yourself by touching something made of metal before handling any sensitive electronic parts.
- After a drive is replaced, it will take about 30 minutes before normal file reading and writing are restored. Settings may not be accessible during this period.
- Do not change the order of the drives in the TeraStation. For example, pulling out drive 1 and replacing it with drive 2 may cause data to be corrupted or lost.
- If the LCD panel does not change after a new drive is installed, click *Rediscover Drive* in Settings.

---

# Drive Replacement Procedure

---

## Using JBOD or a Redundant RAID Mode and TeraStation Is On

---

- 1 Open the front cover with the included key.

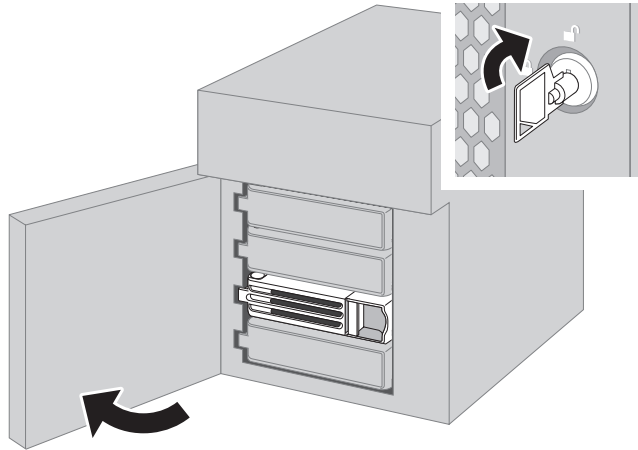

- 2 The failed drive's status LED will be glowing red. Push its unlock button and swing the lock mechanism out.

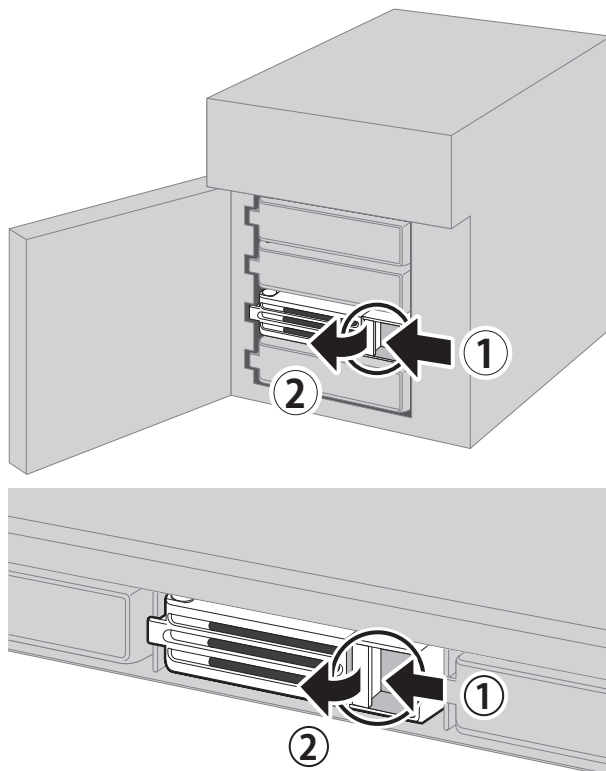

Drives without red status LEDs lit are still on. Do not unplug or remove them.

**3** Pull out the drive cartridge and remove it from the TeraStation.

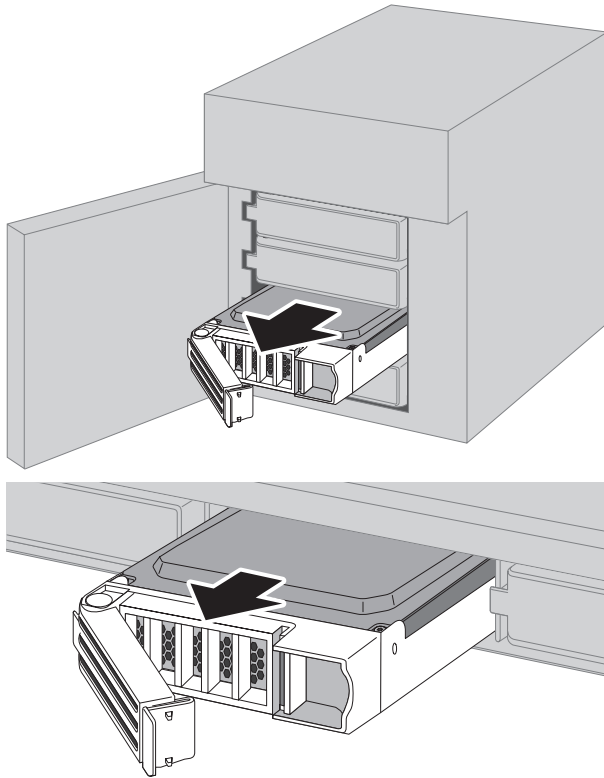

**4** Insert the new drive into the empty slot. Slide the drive in with the locking mechanism open.

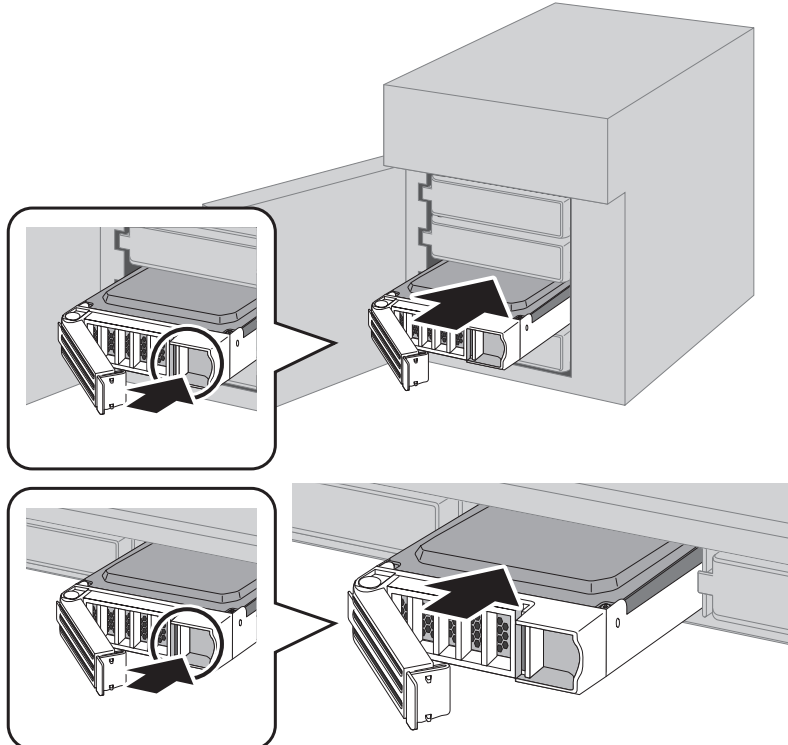

**5** Swing the lock back down until it clicks into place.

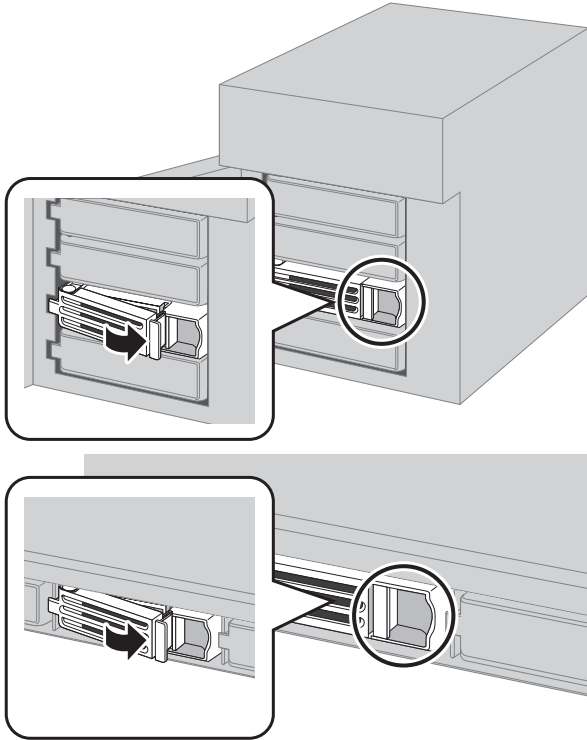

**6** Close the front cover.

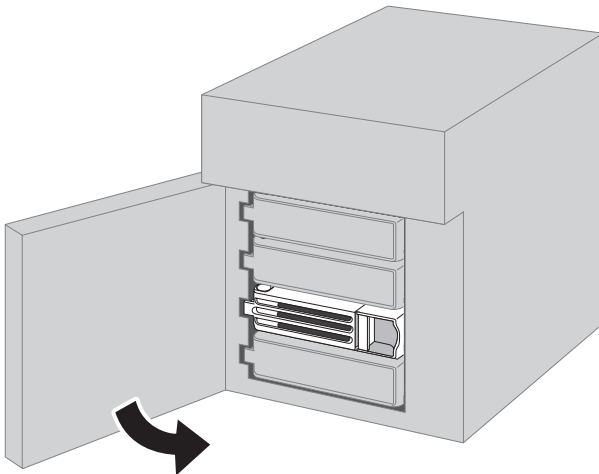

**7** When the replacement drive is recognized, the status LED will flash red and the I31 message will be displayed on the LCD panel.

**8** Press the function button on the front of the TeraStation. The TeraStation will beep. If replacing multiple malfunctioning drives at once, select the replaced drives on Settings and click *Recover RAID Array*.

**9** For RAID 1, 5, or 6:

The TeraStation will start rebuilding the RAID array automatically. After a few minutes, the I18 message will be displayed until the array is rebuilt.

For JBOD:

The drive will be formatted as an individual drive. Create a shared folder on the drive before use.

## **Using a Redundant RAID Mode and TeraStation Is Off**

---

**1** Open the front cover with the key.

- 2** The failed drive's status LED will be glowing red. Push its unlock button and swing the lock mechanism out.
- 3** Pull out the drive cartridge and remove it from the TeraStation.
- 4** Insert the new drive into the empty slot. Slide the drive in with the locking mechanism open. Swing the lock back down until it clicks into place.
- 5** Close the front cover.
- 6** Press the power button on the TeraStation.
- 7** When the replacement drive is recognized, the status LED will flash red and the I31 information message will be displayed on the LCD panel.
- 8** Press the function button on the front of the TeraStation. The TeraStation will beep. If replacing multiple malfunctioning drives at once, select the replaced drives on Settings and click *Recover RAID Array*.
- 9** The TeraStation will start rebuilding the RAID array automatically. It will take about 5 minutes before the I18 message is displayed.

## Using RAID 0

---

Drives in a RAID 0 array do not automatically turn off in the event of a malfunction. Before replacing the failed drive, shut down the TeraStation.

This section describes the process of replacing a drive with **the TeraStation off**.

**Note:** If a drive malfunctions in RAID 0, all data on the RAID array will be lost. All of the settings for the shared folders (such as access restrictions) are erased after replacing a drive from a RAID 0 array.

- 1** Open the front cover with the included key.
- 2** The failed drive's status LED will be blinking red. Push its unlock button and swing the lock mechanism out.
- 3** Pull out the drive cartridge and remove it from the TeraStation.
- 4** Insert the new drive (sold separately) into the empty slot. Slide the drive in with the locking mechanism open. Swing the lock back down until it clicks into place.
- 5** Close the front cover.
- 6** When the replacement drive is recognized, the status LED will flash red and the I32 information message will be displayed on the LCD panel.  
Select the RAID array from *Storage - RAID* in Settings and click *Delete RAID Array*. In *Storage - Drives*, click *Format Drive* to format the new drive. In *Storage - RAID*, choose the type of RAID array desired. Enter the confirmation number and click *OK*. Create a shared folder before use.

## Using a Hot Spare

---

If your TeraStation's drives are in a redundant RAID mode and you have a hot spare enabled, a malfunctioning drive in the array is replaced by the spare drive and the RAID array is rebuilt automatically. The status LED will continue to glow red for the failed drive even after the RAID array is rebuilt with the hot spare. This section describes the replacement process for a drive while **the TeraStation is still on**.

- 1** Open the front cover with the included key.

**2** The failed drive's status LED will be glowing red. Push its unlock button and swing the lock mechanism out.

**3** Pull out the drive cartridge and remove it from the TeraStation.

**4** Insert the new drive into the empty slot. Slide the drive in with the locking mechanism open. Swing the lock back down until it clicks into place.

**5** Close the front cover.

**6** When the replacement drive is recognized, the status LED will flash red and the I31 information message will be displayed on the LCD panel.

**7** Press the function button on the front of the TeraStation. The TeraStation will beep. The replacement drive is automatically registered as a hot spare.

To use the replacement drive as a normal drive rather than a hot spare, navigate to *Storage - RAID* and click the RAID array, select the new drive, and click *Set as a normal drive*.

**Note:** If a drive fails in the RAID array before it is rebooted, the hot spare will not automatically replace the failed drive. In this case, follow the procedure below to repair the array.

- (1) In Settings, navigate to *Storage - Drives*.
- (2) Click the drive that was configured as a hot spare, then click *Dismount Drive*.
- (3) Click *Rediscover Drive*.
- (4) Navigate to *Storage - RAID*.
- (5) Choose the RAID array to repair.
- (6) Click the drive that was previously configured as a hot spare, then click *Recover RAID Array*. This will rebuild the RAID array.

---

## Replacing a Non-Malfunctioning Drive

---

**Do not replace a drive that is not malfunctioning.**

If you must change a drive that is not malfunctioning, either first dismount it in Settings, referring to the "Dismounting Drives" section in chapter 4, or shut down the TeraStation before replacing the drive. If you need to replace more than one drive at the same time, replace the drives one at a time to preserve your data. When replacing the non-malfunctioning drive, the RAID array will function as below:

### Operating in RAID 0 Mode

All data on the RAID array will be deleted after replacing the drive. You will not be able to use the TeraStation until you delete and rebuild the RAID array with the new drive.

### Operating in JBOD

All data on that drive will be deleted after replacing the drive. You will not be able to use the TeraStation until you format the new drive.

### Operating in a Redundant RAID Mode

If you are using a redundant RAID mode such as RAID 1, 5, or 6, the RAID array will be in degraded mode after replacing the drive. You will not be able to use the TeraStation until you rebuild the RAID array with the new drive.

# Chapter 9 Utilities

## NAS Navigator2 for Windows

NAS Navigator2 is a utility program that makes it easy to display Settings, change the TeraStation's IP address, or check its drive. To install NAS Navigator2, download the installer from <http://d.buffalo.jp/TS5010/>.



Double-click the  icon to start NAS Navigator2.

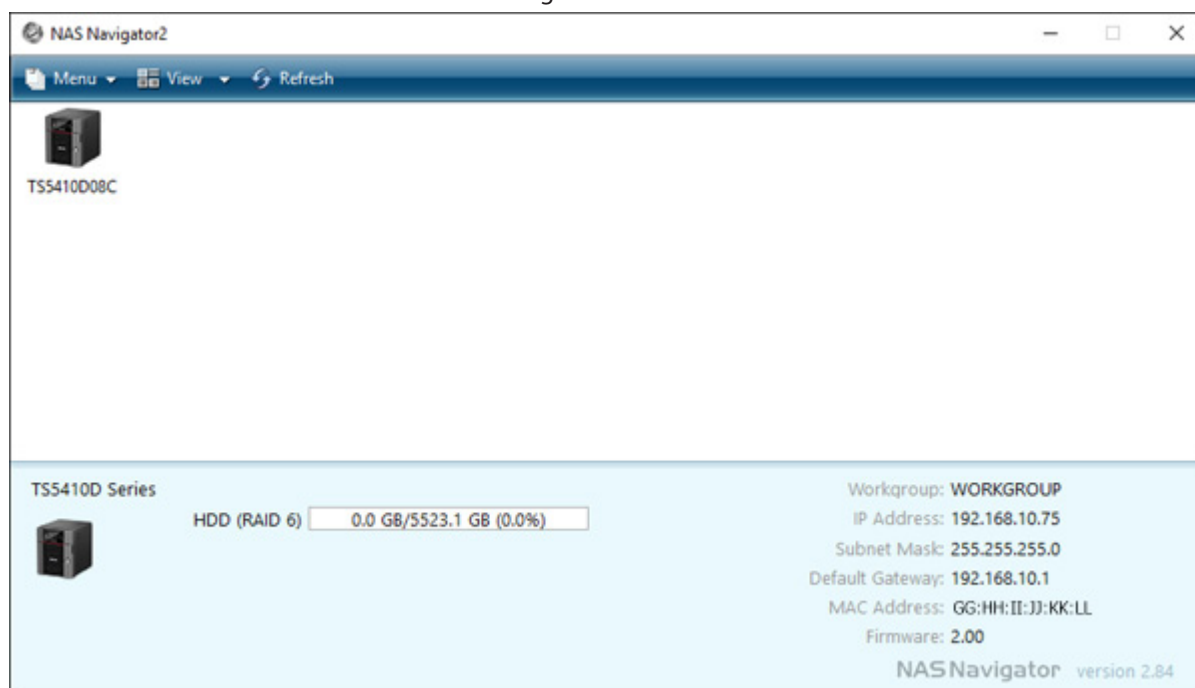

Click your TeraStation's icon to open a share on the TeraStation and display:

- Total capacity
- Capacity in use
- IP address
- Workgroup
- Subnet mask
- Default gateway
- MAC address
- Firmware version

Name		Description
Menu	Map Share*	Assigns the LinkStation's or TeraStation's shared folder as a network drive.
	Disconnect Share*	Unmaps the network drive.
	Map All Remote Shares to Drive Letters	Assigns all the LinkStations' or TeraStations' shared folders as network drives.
	Create Desktop Shortcut*	Creates a desktop shortcut to the selected LinkStation's or TeraStation's shared folders.
	Launch NAS Navigator2 on Startup	Launches NAS Navigator2 in the system tray when Windows boots.
	Display Errors	If an error occurs, an error message will pop up from the NAS Navigator2 icon in the system tray.
	Properties*	Opens the selected LinkStation's or TeraStation's properties page.
	Close	Closes NAS Navigator2.
View	View	Icons: Displays icons. Details: Displays the hostname, product name, workgroup, IP address, subnet mask, and default gateway.
	Sort by	If you have multiple LinkStations and TeraStations on the network, you may choose to display them in order of hostname, product name, workgroup, IP address, subnet mask, or default gateway.
Browse*		Opens the selected LinkStation's or TeraStation's shared folders.
Refresh		Searches for NAS devices on the network again.
I'm here*		Causes your LinkStation or TeraStation to beep.
Right-click your device's icon to show these options.	Browse Shares	Opens the selected LinkStation's or TeraStation's shared folders.
	Settings	Opens Settings for the selected LinkStation or TeraStation.
	Properties	Opens the selected LinkStation's or TeraStation's properties page.
	Map Share	Assigns the LinkStation's or TeraStation's shared folder as a network drive.
	Disconnect Share	Unmaps the network drive.
	Create Shortcut	Creates a desktop shortcut to the selected LinkStation's or TeraStation's shared folders.
	I'm here	Causes your LinkStation or TeraStation to beep.

\* Click on the LinkStation's or TeraStation's icon to display these options.

When NAS Navigator2 is closed, right-click on the NAS Navigator2 icon in the system tray for the following options.

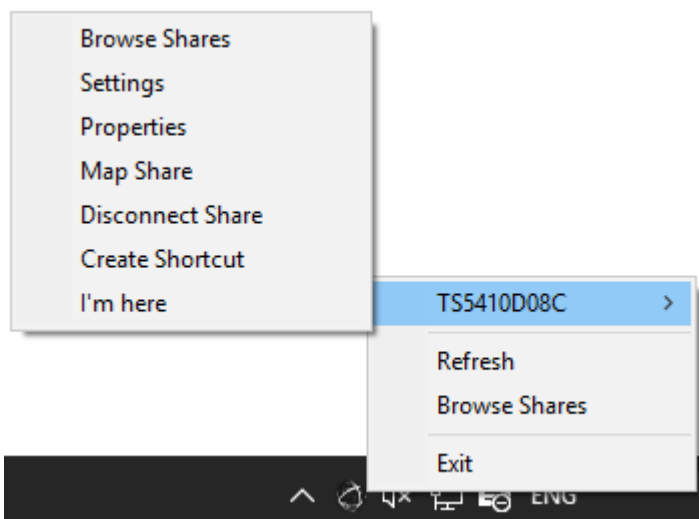

Name		Description
LinkStation or TeraStation Name	Browse Shares	Opens the selected LinkStation's or TeraStation's shared folders.
	Settings	Opens Settings for the selected LinkStation or TeraStation.
	Properties	Opens the selected LinkStation's or TeraStation's properties page.
	Map Share	Assigns the LinkStation's or TeraStation's shared folder as a network drive.
	Disconnect Share	Unmaps the network drive.
	Create Shortcut	Creates a desktop shortcut to the selected LinkStation's or TeraStation's shared folders.
	I'm here	Causes your TeraStation to beep.
Refresh		Refreshes list of NAS devices.
Browse Shares		Displays NAS Navigator2 window.
Exit		Exits NAS Navigator2.

The following tasks may be performed from the LinkStation's or TeraStation's properties page.

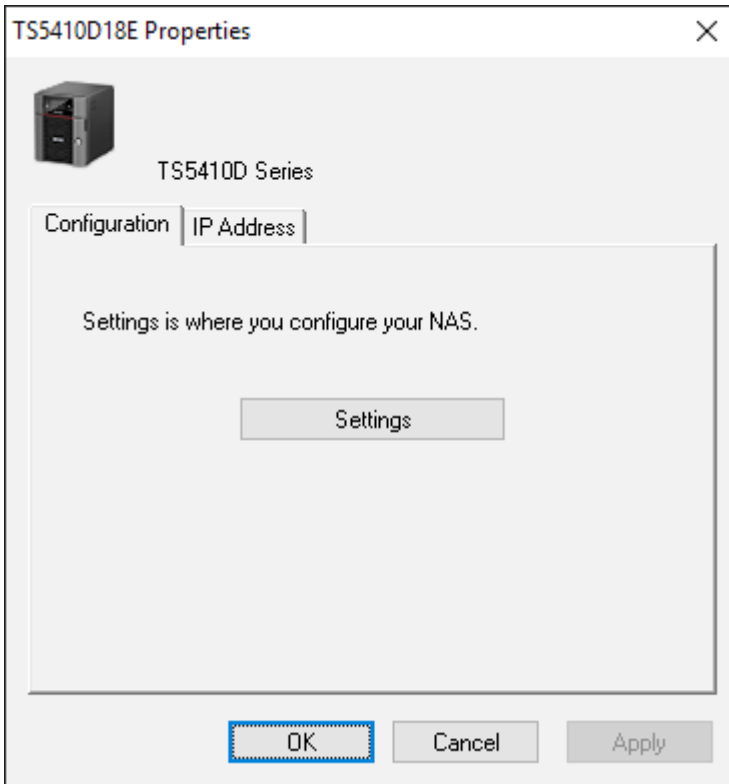

Name	Description
Configuration	Click <i>Settings</i> to open the configuration interface.
IP Address	Select the "Use DHCP" checkbox to assign an IP address from the DHCP server automatically. If there is no DHCP server on the network, you cannot use this function. Select the "Renew IP address" checkbox to obtain an IP address from the DHCP server. You can manually enter an IP address, subnet mask, and default gateway.

## Mounting as a Network Drive

---

You can easily map a shared folder as a network drive using NAS Navigator2.

- 1 Double-click the  icon to start NAS Navigator2.

**2** Right-click on the TeraStation's icon, then click *Map Share*.

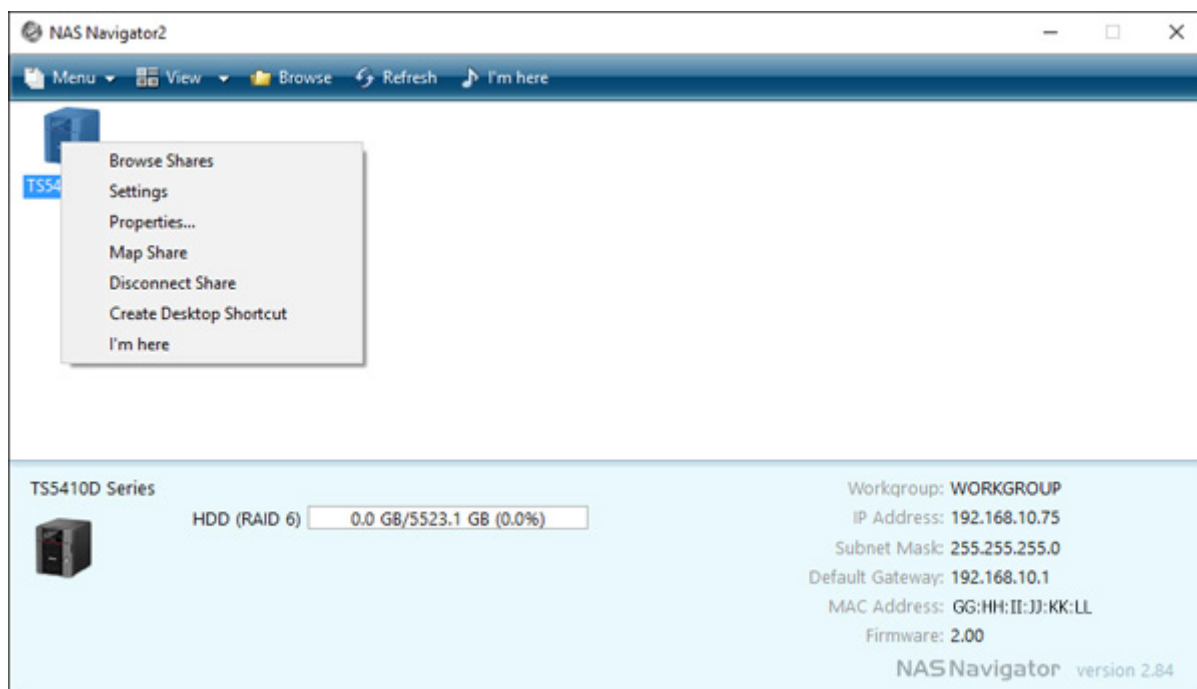

**3** An icon for the mapped share will appear in Computer. You can use this network drive just like any other drive.



## **Changing the IP Address**

---

**1** Double-click the  icon to start NAS Navigator2.

**2** Right-click on your TeraStation's icon and choose *Properties - IP Address*.

- 3** Clear the "Use DHCP" checkbox and enter the desired settings, then click *OK*. If the username and password prompt appears, enter the admin username and password.

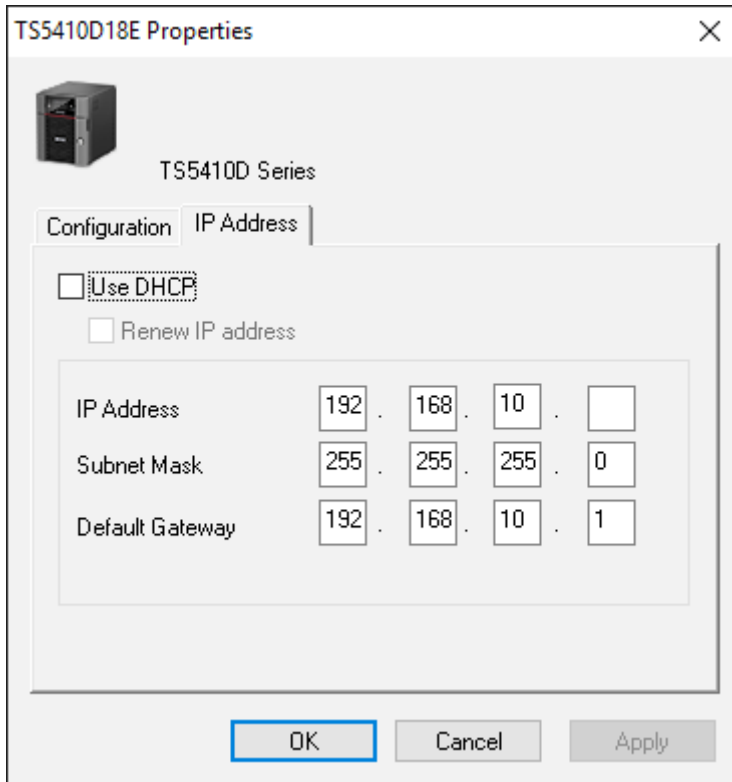

**Note:** The following IP addresses are reserved and should not be used. If you configure one of them by accident, initialize all settings using the init button on the TeraStation.

- Local loopback address: 127.0.0.1, 255.255.255.0
- Network address: 0.0.0.0, 255.255.255.0
- Broadcast address: 255.255.255.255, 255.255.255.0
- The IP address range from 224.0.0.0 to 255.255.255.255

---

## NAS Navigator2 for Mac

---

NAS Navigator2 is a utility program that makes it easy to display Settings, change the TeraStation's IP address, or check its drive. To install NAS Navigator2, download the installer from <http://d.buffalo.jp/TS5010/>.



To launch it, click the  icon in the Dock.

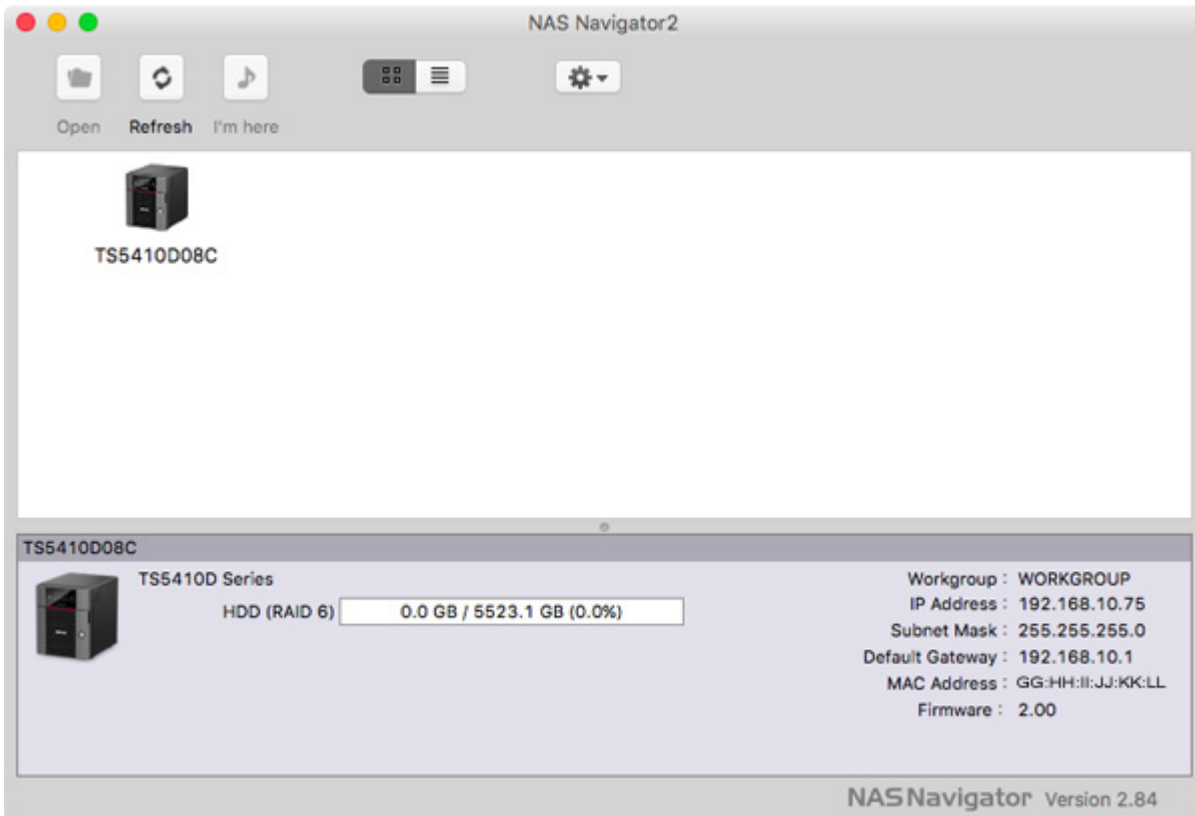

Click on a TeraStation's icon to display:

- Total capacity
- Used capacity
- Workgroup
- IP address
- Subnet mask
- Default gateway
- MAC address
- Firmware version

Double-click it to open a share on the TeraStation.

Name	Description
Open	Opens the default shared folder for a selected LinkStation or TeraStation.
Refresh	Searches for NAS devices on the network again.
I'm here	Causes your LinkStation or TeraStation to beep.
Settings	Opens Settings for the selected LinkStation or TeraStation.
Configure	Opens a window that lets you configure NAS's IP address or open Settings.
Label Color	Selects the color of the name displayed below the icon.
View Options	Lets you choose icon size, position, and view mode.
Auto Power Mode	Auto power mode can turn supported TeraStations and LinkStations on the network on and off automatically.

Name	Description	
To display these options, hold down the control key and select your TeraStation's icon.	Open Folder	Opens the selected LinkStation's or TeraStation's shared folder.
	Settings	Opens Settings for the selected LinkStation or TeraStation.
	Configure	Opens a window that lets you configure the NAS's IP address or open Settings.
	I'm here	Causes your LinkStation or TeraStation to beep.
	Label Color	Selects the color of the name displayed below the icon.

The following tasks may be performed from the LinkStation's or TeraStation's properties page.

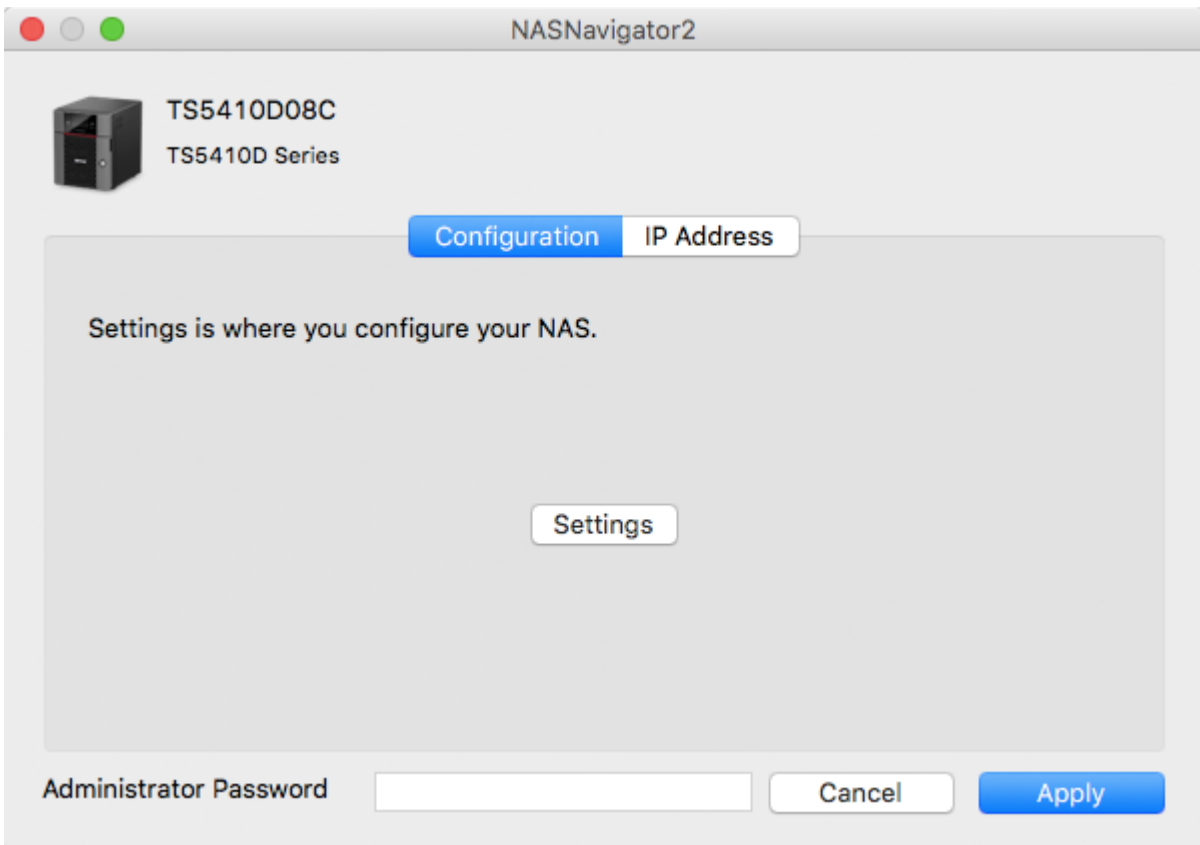

Name	Description
Configuration	Click <i>Settings</i> to open the configuration interface.
IP Address	Select the <i>Use DHCP</i> checkbox to assign an IP address from the DHCP server automatically. If there is no DHCP server on the network, you cannot use this function. Select the <i>Renew IP address</i> checkbox to obtain an IP address from the DHCP server. You can manually enter an IP address, subnet mask, and default gateway.

## Mounting as a Network Drive

You can map a shared folder as a network drive using NAS Navigator2 on macOS.

- 1 Click the  icon in the Dock to start NAS Navigator2.

- 2 Double-click the TeraStation icon or click the TeraStation icon while holding down the control key, then select *Open Folder*. Enter a username and password with the rights to access the shared folder.

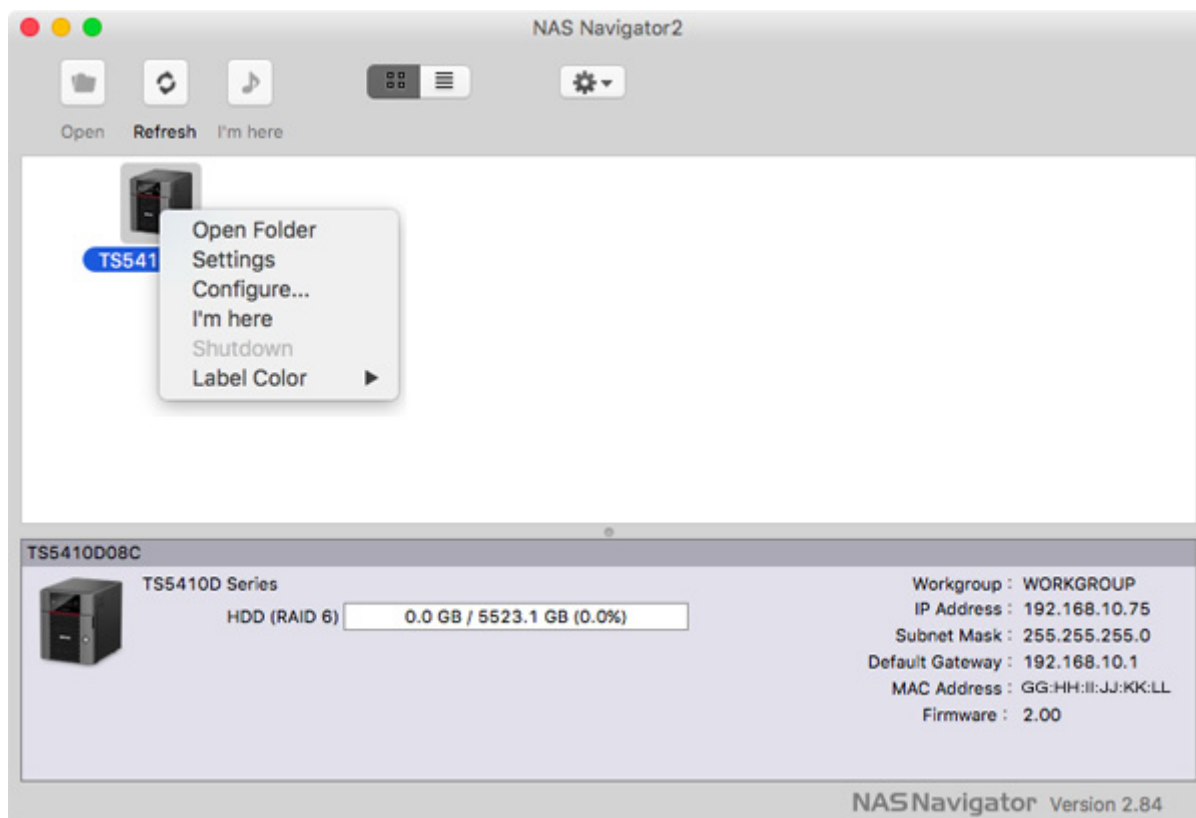

- 3 Select the shared folder that you want to mount, then click *OK*.

- 4 The shared folder is now mounted as a network drive.

## Changing the IP Address

---

- 1 Click the  icon in the Dock to start NAS Navigator2.
- 2 Click the TeraStation icon while holding down the control key, then choose *Configure - IP Address*.

- 3 Clear the "Use DHCP" checkbox; enter the desired settings and the administrator password, then click *Apply*.

The screenshot shows the NASNavigator2 Configuration window for a TS5410D08C device. The 'IP Address' tab is selected. The 'Use DHCP' checkbox is unchecked. The 'Renew IP address' checkbox is also unchecked. The IP Address field is empty. The Subnet Mask is set to 0.0.0.0. The Default Gateway is set to 192.168.10.1. An Administrator Password field is present at the bottom, along with Cancel and Apply buttons.

**Note:** The following IP addresses are reserved and should not be used. If you configure one of them by accident, initialize all settings using the init button on the TeraStation.

Local loopback address: 127.0.0.1, 255.255.255.0

Network address: 0.0.0.0, 255.255.255.0

Broadcast address: 255.255.255.255, 255.255.255.0

The IP address range from 224.0.0.0 to 255.255.255.255

---

## NovaBACKUP

---

NovaBACKUP is a Windows utility that lets you back up the data on your computer.

The NovaBACKUP installer is available from <http://d.buffalo.jp/TS5010/>. Select the region and model to go to your specific model's d.buffalo website. Download the NovaBACKUP installer and install it onto your computer.

To download the installer, you will need the serial number of your TeraStation. The serial number is printed on the label on the back or top of the unit. For your rackmount model, the serial number is located in front as well. Refer to the "Diagrams" section in chapter 1 for the information where the serial number is located.

# Chapter 10 Appendix

## TeraStation Does Not Boot Properly

If an error occurs that prevents the TeraStation from booting up properly, one or more of the following symptoms may occur:

- The power LED keeps blinking instead of turning into a solid glow.
- An "i" symbol is displayed with the TeraStation icon and "EM" is added to your TeraStation's hostname.
- The LCD panel lights up in red with the "Invalid Firmware" message.

In such cases, follow the appropriate procedure(s) below to recover from the error.

## Booting the TeraStation in Emergency Mode

If the TeraStation boots up in emergency mode, depending on your TeraStation model, an "i" symbol is displayed with the TeraStation icon and "EM" is added to your TeraStation's hostname, or the LCD panel lights up in red with the "Invalid Firmware" message.



To recover from emergency mode, follow the procedure below.

- 1** Download the firmware updater from the Buffalo website.
- 2** Extract the downloaded file by double-clicking it and launch the updater.
- 3** Update the firmware for the TeraStation unit that is currently in emergency mode.

When the "i" symbol and "EM" disappear from the icon and the hostname on NAS Navigator2, and the LCD panel returns to glowing blue, the TeraStation is no longer in emergency mode.

**Note:** If the TeraStation does not shut down properly due to a power outage or the power cable getting disconnected while the TeraStation is on, data on the TeraStation may be erased from the shared folders when the TeraStation boots in emergency mode. In such a case, the erased data may not be recovered even if you try the procedure above.

## Power LED Keeps Blinking

While the TeraStation boots up, the power LED is normally blinking and changes to a glowing green when the bootup finishes. If the power LED does not change to a glowing green, follow the procedure below.

- 1** Press and hold the power button for 3 seconds to turn off the TeraStation.
- 2** Turn it on while holding down the function button.

**3** The TeraStation will be in emergency mode. Refer to and follow the procedure in the "Booting the TeraStation in Emergency Mode" section above and update the firmware.

**Note:** If you fail to update the firmware, try the procedure of recovering from emergency mode from step 1 again.

---

## Cleaning the Dustproof Filter

---

If your TeraStation has a front cover and you are trying to clean the dustproof filter on the front cover, follow the procedure below.

**1** Open the front cover with the included key.

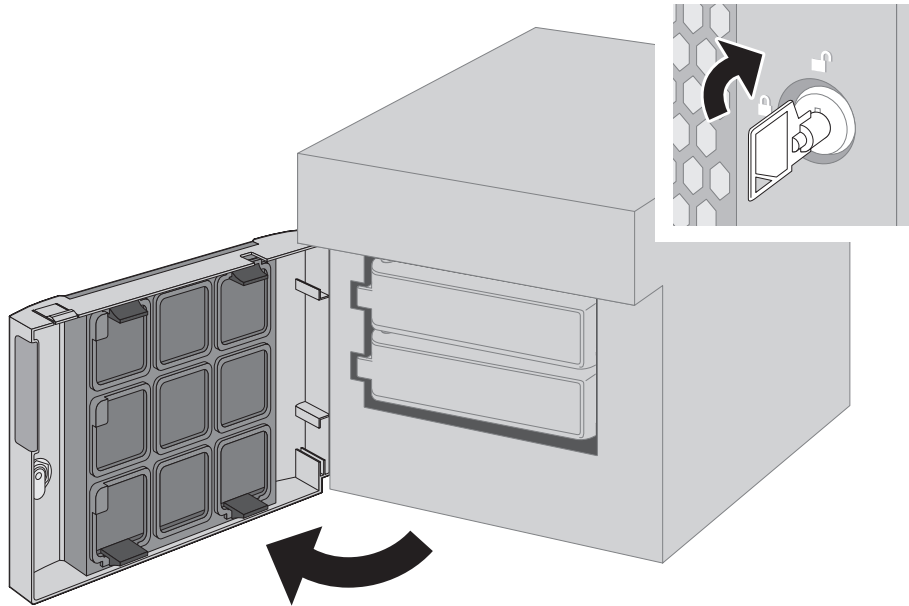

**2** Remove the front cover while holding the hook downward.

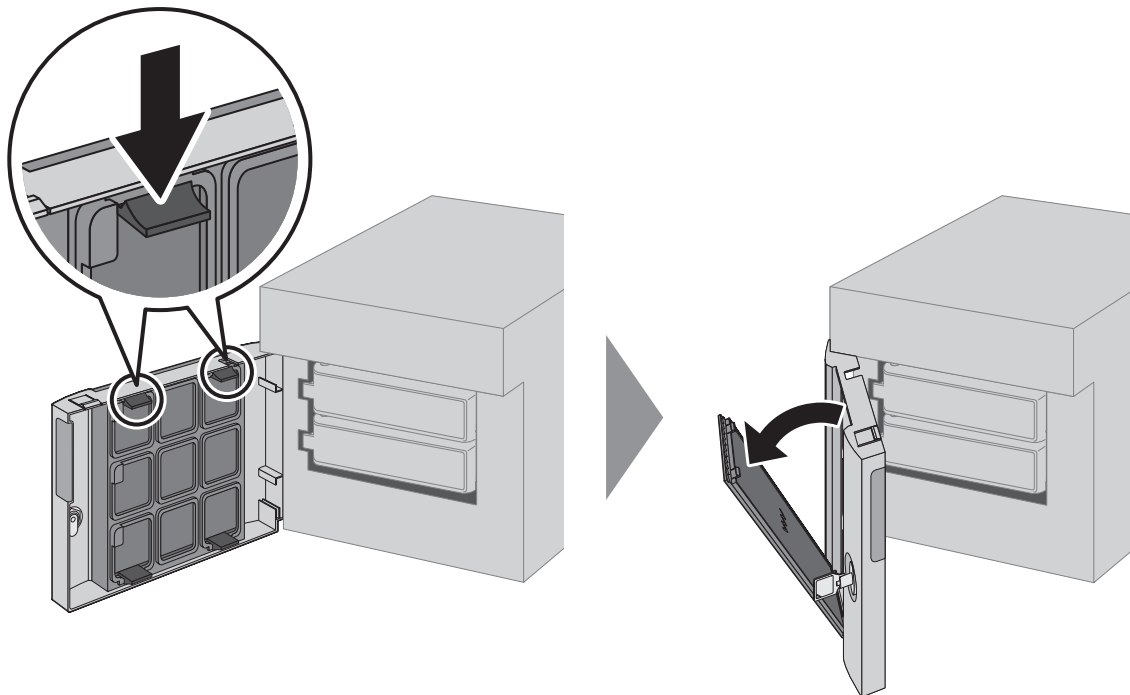

**3** Remove the dustproof filter from the front cover and clear any dust, such as by using a vacuum cleaner.

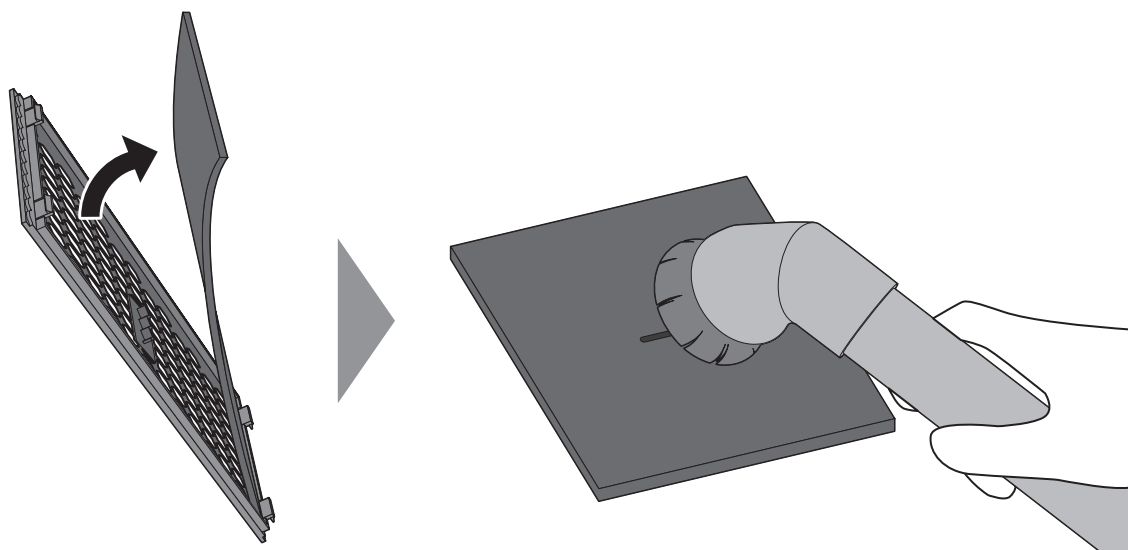

**4** When cleaning is finished, return the filter and the front cover.

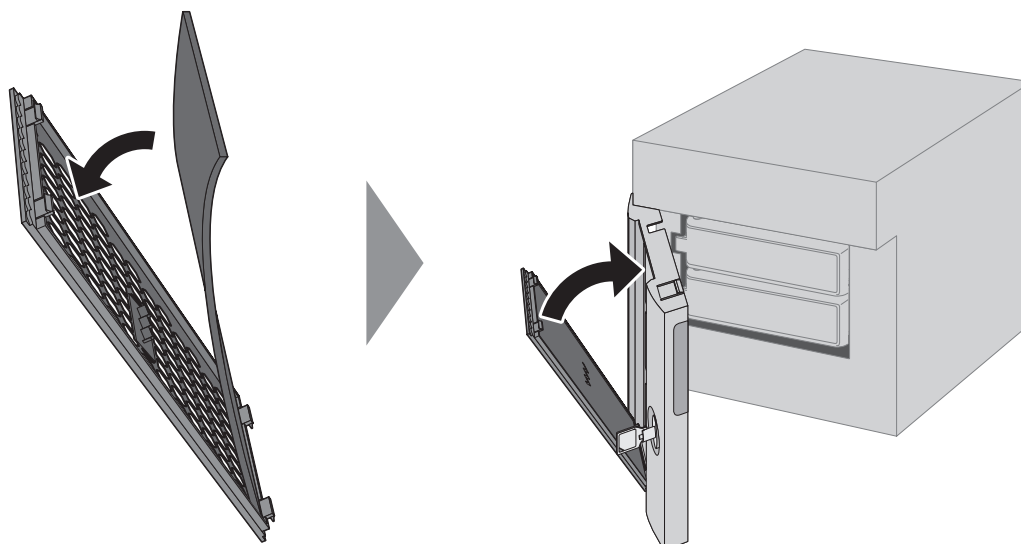

**5** Close the front cover.

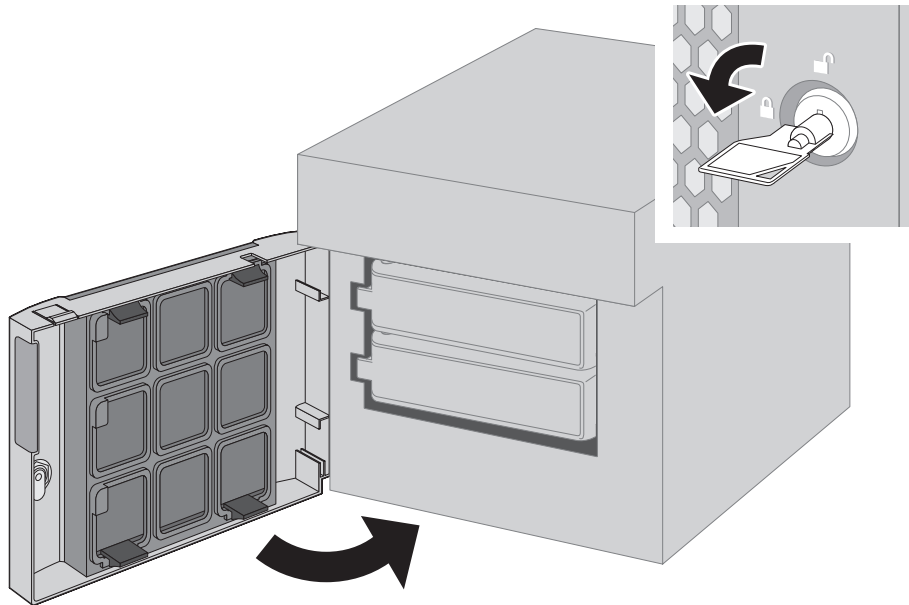

## LCD Panel

The LCD panel can be cycled through different modes by pressing the display button on the front of the TeraStation.

### Modes

LCD Message		Description	Corrective Action
LANx <b>Note:</b> The "x" indicates the number of the LAN port where the Ethernet cable is connected.	LANx Not Connected	Not connected to a network.	Connect an Ethernet cable to the LAN port.
	LANx Half Duplex 10 Mbps	Connected at 10 Mbps half duplex.	-
	LANx Full Duplex 10 Mbps	Connected at 10 Mbps full duplex.	-
	LANx Half Duplex 100 Mbps	Connected at 100 Mbps half duplex.	-
	LANx Full Duplex 100 Mbps	Connected at 100 Mbps full duplex.	-
	LANx 1000 Mbps	Connected at 1000 Mbps.	-
	LANx 2.5 Gbps	Connected at 2.5 Gbps.	-
	LANx 5 Gbps	Connected at 5 Gbps.	-
	LANx 10 Gbps	Connected at 10 Gbps.	-
	LANx Port Trunking	Displays if port trunking is configured.	-

LCD Message		Description	Corrective Action
Model Name/ Firmware Version	TS5410D FW Version 1.00	Displays the model name and firmware version of your model. <b>Note:</b> This example is using a TS5410DN unit. The numbers and letters after "TS" may vary depending on your model.	-
Hostname	Hostname: TS5410Dxxx	Displays the hostname.	-
Date and Time	Date Time YYYY/MM/DD hh:mm	Displays the date and time set in the TeraStation.	-
IP Address	LANx DHCP 192.168.11.150	Displays the IP address. If acquiring from a DHCP server automatically, "DHCP" will be displayed. If configuring a static IP address, "Static IP" will be displayed.	-
	LANx Port Trunking	Displays if port trunking is configured.	-

## Errors

LCD Message	Description	Corrective Action
Invalid Firmware	The firmware is corrupted and the TeraStation boots in emergency mode.	Update the TeraStation firmware to recover from emergency mode by following the procedure in the "Booting the TeraStation in Emergency Mode" section above. If the error is displayed again, contact Buffalo technical support for assistance.
E10 UPS Running Off Battery	The TeraStation is running on the UPS battery due to a power outage.	Shut down the TeraStation safely and wait until the power outage ends. If certain settings are configured, the TeraStation may shut down automatically when the error is detected.
	If the setting to use the UPS connected to this TeraStation has been configured, the UPS cable may be disconnected.  If the setting to use the UPS connected to another TeraStation on the same network has been configured, the LAN cable of this TeraStation may be disconnected.	Verify that the UPS cable or LAN cable is connected properly.
E11 Fan Failure	An error occurred in the fan speed.	Check that no foreign objects or dust are clogging the fan. If any foreign objects or dust are found, use a pair of tweezers, air duster, or other tool to remove them. If the error is displayed again, contact Buffalo technical support for assistance.
E12 Cooling Failure	A rise in the system temperature may have exceeded the allowable safety value.	Do not place objects in the area around the TeraStation. Also, move the TeraStation to a cool location.
E14 Can't Mount Array x	The RAID array cannot be mounted.	Run the RAID array drive check in Settings.
E16 Drive x Not Found	Unable to find the drive.	The drive may be disconnected or may have failed. After shutting down, reinstall the drive.

LCD Message	Description	Corrective Action
E22 Can't Mount Drive x	Unable to mount the drive.	Format the drive. After formatting, if the error still appears after rebooting, replace the drive. If the error is displayed again, contact Buffalo technical support for assistance.
E27 Lost Failover Target	Unable to find the backup TeraStation.	In the main TeraStation's Settings, navigate to <i>Backup - Failover</i> to reconfigure the backup TeraStation for failover.
E30 Replace Drive x	An error occurred, so the drive was removed from the RAID array.	Replace the drive.

## Status

After you change settings or format a drive, the current status is displayed on the LCD panel.

LCD Message	Description	Corrective Action
I10 System Is Overheating	A rise in the system temperature may have exceeded the allowable safety value.	Move the TeraStation to a cool location. Do not place objects in the area around the TeraStation.
I11 Bad Sectors on Drive x	The drive has too many bad sectors.	Replace the drive.
I12 Degraded Mode	Operating in degraded mode.	-
I13 Formatting Array x...	Formatting the RAID array.	-
I14 Checking Array x...	Checking the RAID array.	-
I15 Scanning Array x Data...	Examining the error status of the RAID array. <b>Note:</b> Transfer speeds are slower during the examination process.	-
I16 Creating Array x...	Creating the RAID array.	-
I18 Rebuilding Array x...	Rebuilding the RAID array. <b>Note:</b> Transfer speeds are slower during the rebuilding process.	-
I19 Filling Array x with 0s	Writing 0s to the RAID array and erasing all data.	-
I20 Formatting Drive x...	Formatting the drive.	-
I21 Checking Drive x...	Checking the drive.	-
I22 Filling Drive x with 0s	Writing 0s to the drive and erasing all data.	-
I25 Updating Firmware...	Updating the TeraStation firmware. <b>Note:</b> Do not turn off the power during the updating process.	-
I26 Initializing Settings...	Initializing all settings.	-
I27 Checking USB Drive x...	Checking the USB drive.	-
I28 Formatting USB Drive x...	Formatting the USB drive.	-

LCD Message	Description	Corrective Action
I31 Push Func to Use New Drive x	Displays when pressing the function button to rebuild the RAID after replacing the drive.	Press the function button to rebuild the RAID array.
I32 New Drive x Detected	Displays after replacing the drive when the RAID needs to be rebuilt in Settings or formatting is necessary.	In Settings, either rebuild the RAID array or format the drive.
I33 Replication Failure	An error occurred in replication, or synchronization between the main TeraStation and the backup TeraStation failed during failover configuration.	In Settings, navigate to <i>Backup - Replication</i> and click <i>Resync</i> to execute resynchronization. If the error is displayed again, contact Buffalo technical support for assistance.
I37 Recovering System...	Settings initialization in progress.	-
I38 Recovery Finished	Settings initialization is complete.	-
I40 All Data Will Be Deleted	Beginning settings initialization. All data on the drive 1 will be deleted.	-
I41 Push Func to Start Recovery	Press the function button on the front to start the settings initialization process.	-
I42 Preparing Recovery	Preparing to start the settings initialization process.	-
I43 Unsupported Hardware	The TeraStation was started from the USB initialization device, but the settings cannot be initialized from this USB initialization device.	-
I44 Drive 1 Not Found	Initialization from the USB initialization device was initiated, but drive 1 was not detected.	Make sure that drive 1 is present and fully inserted in its slot.
I45 Recovery Failed	Initialization failed.	-
I46 Migrating RAID Array x...	Data migration or conversion (RAID migration) is in progress.	Do not turn off the TeraStation's power.
I47 Don't Power Off System!		
I48 Push Func to Start Failover	This TeraStation is ready to become the failover backup for the main TeraStation.	Hold down the function button on the front of the target TeraStation until it stops beeping to accept failover backup status.
I49 Lost Failover Main	The main TeraStation in the failover configuration cannot be found.	Make sure that the main TeraStation is on, working, and connected to the network.
I50 Failover in Maintenance Mode	Failover maintenance is in progress.	Do not turn off the TeraStation's power.
I51 Initializing Failover...	Initializing the failover configuration.	Do not turn off the TeraStation's power.
I52 New Firmware Available	A new firmware version has been released.	Update the firmware.
I54 Backup Job x Failed	The backup job failed.	Make sure that the backup job is configured correctly. Make sure that the NAS is on and not in standby mode. If the backup job still fails, check the status of NAS, network, and backup source and destinations.

LCD Message	Description	Corrective Action
I55 Recovery Not Authorized	Authentication during initialization of settings failed.	Settings can only be restored for the TeraStation whose settings were originally saved.
I59 Boot Auth Failed	Boot authentication failed.	Open Settings, take note of the displayed decryption key, and forward the key to the authentication server administrator.

## Default Settings

Administrator's Name	admin	
Password	password	
Shared Folders	"share" for both Windows and Mac computers. The recycle bin is enabled on "share" by default.	
DHCP	<p>Enabled</p> <p>Normally, the TeraStation will get its IP address automatically from a DHCP server on the network. If no DHCP server is available, then an IP address will be assigned as follows:</p> <p>IP Address: 169.254.xxx.xxx (xxx is assigned randomly when booting the TeraStation.)</p> <p>Subnet Mask: 255.255.0.0</p>	
Registered Groups	"hdusers", "admin", and "guest" You cannot edit or delete these default groups.	
Microsoft Network Group Settings	WORKGROUP	
MTU Size	1500 bytes	
SMB	Enabled	
	SMB Protocol	Auto
	Recycle Bin Permissions	All users
	Mac OS Temp Files	Keep when original file is deleted
AFP	Enabled	
FTP	Disabled	
SFTP	Disabled	
WebAccess	Disabled	
NFS	Disabled	
RAID Scanning	Disabled	
iSCSI	Disabled	
Cloud Storage	Disabled	
Dropbox Sync	Disabled	
SNMP	Disabled	
Time Machine	Disabled	
NTP	Enabled	
Email Notification	Disabled	
Init Button Settings	Restore admin username and password to factory defaults	
Boot Authentication	Disabled	
RAID Mode	TS5410DN, TS5410RN: RAID 5 TS5210DN: RAID 1	

## Specifications

Check the Buffalo website for information about the latest products and specifications.

LAN Interface	Standards Compliance	LAN ports 1 and 2: IEEE 802.3ab (1000BASE-T), IEEE 802.3u (100BASE-TX), IEEE 802.3 (10BASE-T), AUTO-MDIX LAN port 3: IEEE 802.3ae (10GBASE-T), IEEE 802.3bz (2.5GBASE-T, 5GBASE-T), IEEE 802.3ab (1000BASE-T), IEEE 802.3u (100BASE-TX), AUTO-MDIX
	Data Transfer Rates	LAN ports 1 and 2: 10/100/1000 Mbps (auto sensing) LAN port 3: 2.5/5/10 Gbps, 100/1000 Mbps (auto sensing)
	Number of Ports	3
	Connector Type	RJ-45 8-pin
	Supported Protocols	TCP/IP
	Network File Services	SMB/CIFS, AFP, FTP/SFTP, NFS
	Jumbo Frames	1500–9216 byte modes are supported.
USB Interface	TS5410DN, TS5210DN: 2 USB 3.0 ports (type A) TS5410RN: 1 USB 3.0 ports (front, type A) and 2 USB 3.0 port (rear, type A) <b>Note:</b> Supported USB devices include Buffalo USB drives, and USB UPS devices.	
Internal Drives	If a drive in the TeraStation malfunctions, replace it with a Buffalo OP-HDN series drive. Make sure the replacement drive is of the same capacity or larger as the original drive. The drives listed above are available from the Buffalo website.	
Power Supply	AC 100–240 V, 50/60 Hz	
Dimensions (D x W x H)	TS5410DN: 230 x 170 x 215 mm; 9.1 x 6.7 x 8.5 in TS5410RN: 430 x 430 x 44.3 mm; 16.9 x 16.9 x 1.7 in TS5210DN: 230 x 170 x 170 mm; 9.1 x 6.7 x 6.7 in	
Weight	TS5410DN: Approx. 7.0 kg; 15.4 lb TS5410RN: Approx. 8.5 kg; 18.7 lb TS5210DN: Approx. 4.8 kg; 10.6 lb	
Power Consumption	TS5410DN, TS5210DN: Max. 85 W TS5410RN: Max. 100 W	
Operating Environment	Temperature: 0–40°C; 32–104°F Humidity: 10–85% non-condensing	
Compatibility	Windows PCs, tablets, and Mac computers with wired or wireless Ethernet connection. <b>Note:</b> The TeraStation requires an Ethernet connection with your computer for operation. It cannot be connected via USB.	
Supported OS	Windows 10, 8.1, 7 SP1 or later Windows Server 2012 R2, 2012, 2008 R2, 2008 macOS 10.12, 10.11, 10.10, 10.9	

# Chapter 11 Regulatory Compliance Information

---

## For Customers in the United States

---

### FCC Statement

This equipment has been tested and found to comply with the limits for a Class A digital device, pursuant to part 15 of the FCC Rules. These limits are designed to provide reasonable protection against harmful interference when the equipment is operated in a commercial environment. This equipment generates, uses, and can radiate radio frequency energy and, if not installed and used in accordance with the instruction manual, may cause harmful interference to radio communications. Operation of this equipment in a residential area is likely to cause harmful interference in which case the user will be required to correct the interference at his own expense.

This device complies with Part 15 of the FCC Rules. Operation is subject to the following two conditions: (1) This device may not cause harmful interference, and (2) this device must accept any interference received, including interference that may cause undesired operation.

Only use the cables and accessories that are included in the package. Don't use other accessories or cables unless specifically instructed to in the documentation.

### UL and MET

The socket-outlet shall be installed near the equipment and shall be easily accessible.

### Proposition 65

#### WARNING:

This product and its components contain chemicals known to the State of California to cause cancer and birth defects, or reproductive harm. Wash hands after handling.

---

## For Customers in Europe

---

### CE

Dansk

Dette er et Klasse A-produkt. I et hjemmemiljø kan dette produkt skabe radiointerferens, hvormed det kan være nødvendigt for brugeren at tage passende forholdsregler.

Dette produkt kan forårsage interferens hvis det bruges i beboelsesområder. En sådan anvendelse skal undgås, medmindre brugeren tager specielle foranstaltninger for at reducere elektromagnetiske emissioner for at forhindre interferens med modtagelse af radio- og tv-udsendelser.

Der må kun bruges de kabler og det tilbehør der er inkluderet i pakken. Der må ikke bruges andet tilbehør eller kabler, medmindre det er udtrykkeligt beskrevet i dokumentationen.

Brug ikke USB-kabler, der er 3 meter eller længere for at tilslutte USB enheder til denne TeraStation serie.

#### Deutsch

Dies ist ein Produkt der Klasse A. In einer häuslichen Umgebung kann dieses Produkt Funkstörungen verursachen. Um diese zu beheben, müssen ggf. entsprechende Maßnahmen ergriffen werden.

Bei einer Nutzung in Wohngebieten können bei diesem Produkt Störungen auftreten. Eine solche Nutzung soll vermieden werden, außer der Nutzer ergreift bestimmte Maßnahmen, um elektromagnetische Strahlung zu reduzieren und Störungen der Radio- und Fernsehübertragung zu vermeiden.

Verwenden Sie ausschließlich die Kabel und Zubehörteile, die im Lieferumfang enthalten sind. Andere Zubehörteile oder Kabel dürfen nur dann verwendet werden, wenn dies in der Dokumentation ausdrücklich vorgeschrieben ist. Verwenden Sie keine USB-Kabel, die 3 Meter lang oder länger sind, um USB-Geräte an TeraStation dieser Serie anzuschließen.

#### English

This is a class A product. In a domestic environment, this product may cause radio interference, in which case the user may be required to take adequate measures.

This product may cause interference if used in residential areas. Such use must be avoided unless the user takes special measures to reduce electromagnetic emissions to prevent interference to the reception of radio and television broadcasts.

Only use the cables and accessories that are included in the package. Don't use other accessories or cables unless specifically instructed to in the documentation.

Do not use USB cables that are 3 meters or longer to connect USB devices to this TeraStation series.

#### Español

Este es un producto de Clase A. En una situación doméstica, este producto puede producir interferencias de radio, en ese caso el usuario deberá tomar las medidas adecuadas.

Este producto puede causar interferencias al utilizarlo en áreas residenciales. Debe evitarse utilizarlo así, salvo si el usuario adopta medidas especiales para reducir las emisiones electromagnéticas e impedir que se produzcan interferencias con la recepción de emisiones de radio y televisión.

Utilice únicamente los cables y accesorios incluidos en el paquete. No utilice otros accesorios ni cables a menos que así se indique en la documentación.

Utilice cables de una longitud inferior a 3 metros para conectar los dispositivos USB a este tipo de TeraStation.

#### Français

Cet appareil est un produit de Classe A. Dans un environnement domestique, ce produit est susceptible de provoquer des interférences radio, auquel cas l'utilisateur peut être mis en demeure de prendre des mesures appropriées.

Utilisé dans un environnement domestique, cet appareil génère des interférences. Ce type d'utilisation est donc à éviter si l'utilisateur n'a pas pris de mesures spécifiques visant à réduire les émissions électromagnétiques pour éviter les interférences avec la réception de programmes de radio et de télévision.

Utilisez uniquement les câbles et accessoires inclus dans ce package. N'utilisez aucun autre accessoire ou câble sauf instruction spécifique de la documentation.

Utilisez des câbles d'une longueur de moins 3 mètres pour connecter les périphériques USB à ce type de TeraStation.

#### Italiano

Questo è un prodotto di Classe A. In ambienti domestici il prodotto può causare radiointerferenza, nel qual caso potrebbe rendersi necessaria l'adozione di opportune misure.

Questo prodotto può causare interferenze se usato in zone residenziali. Evitare l'uso in queste zone a meno che l'utente non intraprenda azioni specifiche per ridurre le emissioni elettromagnetiche e impedire le interferenze alla ricezione di trasmissioni radio-televisive.

Utilizzare esclusivamente i cavi e gli accessori inclusi nell'imballaggio. Non utilizzare altri accessori o cavi a meno che non sia specificamente indicato nella documentazione.

Non utilizzare cavi USB lunghi 3 metri o più per collegare dispositivi USB a questa TeraStation.

#### Nederlands

Dit is een Klasse A product. Dit product kan in een huishoudelijke omgeving radiostoring veroorzaken in welk geval de gebruiker adequate maatregelen dient te nemen.

Dit product kan storing veroorzaken wanneer gebruikt in woongebieden. Dergelijk gebruik dient te worden vermeden tenzij de gebruiker speciale maatregelen treft om de elektro-magnetische uitstraling te beperken zodat storing van de ontvangst van radio- en televisieuitzendingen wordt voorkomen.

Gebruik alleen de kabels en toebehoren die zich in de verpakking bevinden. Gebruik geen ander toebehoren of kabels tenzij dit uitdrukkelijk in de handleiding wordt aangegeven.

Gebruik geen USB-kabels die 3 meter of langer zijn om USB-apparaten met deze TeraStation series te verbinden.

#### Norsk

Dette er et produkt i klasse A. I et hjemmemiljø kan dette produktet forårsake radiointerferens, noe som gjør at brukeren i så fall må foreta passende tiltak.

Dette produktet kan forårsake interferens dersom det brukes i boligområder. Slik bruk må unngås med mindre brukeren tar spesielle tiltak for å redusere elektromagnetisk stråling for å unngå interferens med mottak av radio- og TV-sendinger.

Bruk kun kabler og tilbehør som er inkludert i pakken. Ikke bruk annet tilbehør eller kabler med mindre spesielt instruert til å gjøre det i dokumentasjonen.

Bruk ikke USB-kabler på tre meter eller mer for å koble USB-enheter til denne TeraStation-serien.

#### Português

Este é um produto de Classe A. Num ambiente doméstico, este produto pode provocar interferências de rádio, pelo que o utilizador poderá ter de tomar medidas adequadas.

Este produto poderá causar interferências se utilizado em áreas residenciais. A utilização deverá ser evitada, salvo se o utilizador tomar medidas especiais para reduzir as emissões electromagnéticas e assim prevenir interferências na recepção de rádio e televisão.

Utilizar apenas cabos e acessórios incluídos na embalagem. Não utilizar outros acessórios ou cabos, salvo se especificamente indicado na documentação.

Não usar cabos USB de 3 metros ou mais para ligar dispositivos USB a esta série TeraStation.

#### Suomi

Tämä on luokan A tuote. Tämä tuote voi aiheuttaa radiohäiriöitä kotikäytössä, jolloin käyttäjän on ehkä ryhdyttävä tarvittaviin toimenpiteisiin.

Tämä tuote saattaa aiheuttaa häirintää, jos sitä käytetään asuinalueella. Sellaista käyttöä on vältettävä, ellei ryhdytä erityistoimenpiteisiin sähkömagneettisen säteilyn vähentämiseksi häiriöiden estämiseksi radio- ja televisiolähetyksissä.

Käytä ainoastaan pakkauksen mukana toimitettuja kaapeleita ja varusteita. Älä käytä muita varusteita tai kaapeleita ellei näin ole erityisesti ohjeistettu asiakirjoissa.

Älä käytä 3m tai pitempiä USB-kaapeleita USB-laitteiden liittämiseen näille TeraStation-sarjoille.

#### Svensk

Detta är en Klass A-produkt. I en hushållsmiljö kan denna produkt orsaka radiostörningar, och användaren kan i så fall begäras att vidta lämpliga åtgärder.

Den här produkten kan orsaka störningar om den används i bostadsområden. Sådan användning måste undvikas om inte användaren vidtar speciella åtgärder för att minska elektromagnetiska sändningar för att förhindra störningar i mottagningen av radio- och tv-sändningar.

Använd bara kablar och tillbehör som ingår i förpackningen. Använd inte andra tillbehör eller kablar om du inte får uttryckliga instruktioner om det i dokumentationen.

Använd inte USB-kablar som är 3 meter eller längre för att ansluta USB-enheter till den här TeraStation-serien.

#### Türk

Bu, A Sınıfı bir üründür. Evde kullanım sırasında bu ürün radyo girişimine yol açabilir ve bu durumda kullanıcının gerekli önlemleri alması gerekebilir.

Bu ürün yerleşim bölgelerinde kullanılırsa parazite neden olabilir. Kullanıcı radyo ve televizyon yayınlarında parazitli önlemek üzere elektromanyetik salınımları azaltacak özel önlemler almadıkça bu şekilde kullanımdan kaçınılmalıdır. Yalnızca pakette bulunan kablo ve aksesuarları kullanın. Belgelerde özellikle belirtilmedikçe başka aksesuar ve kablolar kullanmayın.

USB aygıtları bu TeraStation serisine bağlamak için 3 metre ve daha uzun USB kabloları kullanmayın.

#### CB

The socket-outlet shall be installed near the equipment and shall be easily accessible.

#### Norsk

Utstyr som er koplet til beskyttelsesjord via nettplugg og/eller via annet jordtilkoplet utstyr – og er tilkoplet et kabel-TV nett, kan forårsake brannfare.

For å unngå dette skal det ved tilkopling av utstyret til kabel-TV nettet installeres en galvanisk isolator mellom utstyret og kabel-TV nettet.

#### Svensk

Utrustning som är kopplad till skyddsjord via jordat vägguttag och/eller via annan utrustning och samtidigt är kopplad till kabel-TV nät kan i vissa fall medföra risk för brand. För att undvika detta skall vid anslutning av utrustningen till kabel-TV nät galvanisk isolator finnas mellan utrustningen och kabel-TV nätet.

---

## For Customers in Taiwan

---

#### BSMI

警告使用者：

此為甲類資訊技術設備，於居住環境中使用時，可能會造成射頻擾動，在此種情況下，使用者會被要求採取某些適當的對策。