

**INSIGNIA™**

# Rear/Bottom Soundbar Mount

NS-SBTVB26

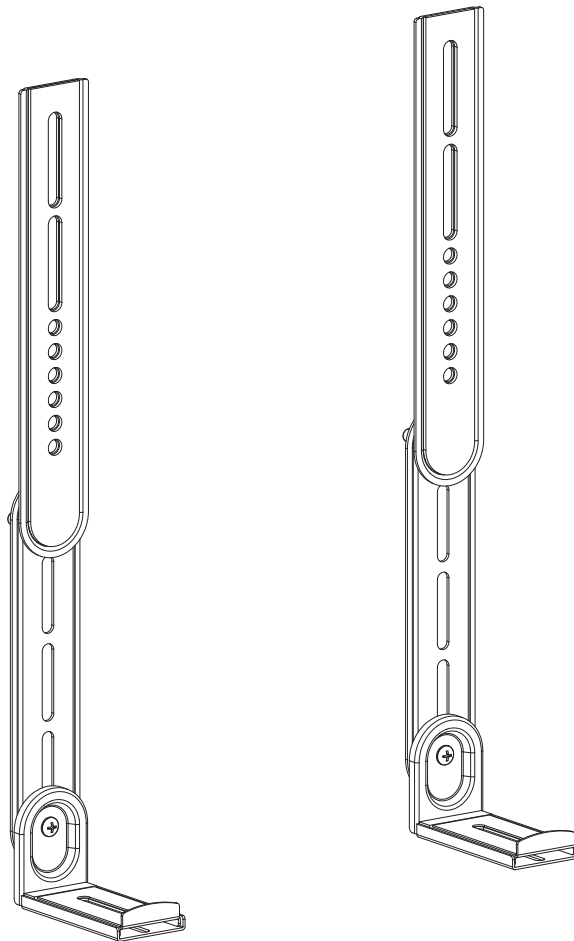

Before using your new product, please read these instructions to prevent any damage.

## Contents

Introduction .....	3
Important Safety Instructions .....	3
Features .....	3
Package contents .....	3
Parts .....	3
Installation hardware .....	4
Soundbar hardware .....	4
TV hardware .....	4
Product dimensions .....	5
Tools needed (Not provided) .....	5
Installing your soundbar mount .....	6
Step 1: Option 1 - Attaching the brackets to your soundbar using the screw holes on the back of your soundbar .....	6
Step 1: Option 2 - Attaching the brackets to your soundbar using the key holes on the back of your soundbar .....	8
Step 1: Option 3 - Attaching the brackets with the extension arms to your soundbar using the mounting holes on the bottom of your soundbar .....	9
Step 2: Installing the bracket assembly/soundbar to your TV mount .....	11
Specifications .....	13
ONE-YEAR LIMITED WARRANTY .....	14

## Introduction

Congratulations on your purchase of a high-quality Insignia product. Your NS-SBTVB26 represents the state of the art in soundbar mount design and is designed for reliable and trouble-free performance.

## Important Safety Instructions

**Read all instructions before use.**

**Keep these instructions.**

### ⚠ CAUTION

- Never let children climb on or play with your product.
- Do not sit or stand on your product.
- Do not place a soundbar that is heavier than the recommended rated load on the stand. Improper installation may cause property damage and/or personal injury. The manufacturer is not liable for damage or injury caused by incorrect mounting, assembly, or use.
- Improper handling can result in cuts and lacerations.
- Pictures are for reference only, subject to our available products.

### ⚠ CAUTION

- This bracket is suitable for items weighing no more than the "maximum load of 15 lbs. (6.8 kg)." The wall must be able to bear four times the total weight of the bracket and the audio cable. Do not over-tighten the screws to avoid injury. Using products with a weight exceeding the indicated maximum weight may cause the bracket and its accessories to collapse, potentially causing injury.
- The product is mounted on the two TV screws (either top or bottom two), hence the TV screws and wall mount must be able to sustain the weight of the complete assembly.

## Features

- Adjustable design supports most soundbars between 3.94-6.89 in. (10-17.5 cm) deep
- Durable steel brackets hold up to 15 lbs. (6.8 kg)
- Silicone padding cushions your soundbar
- Included hardware provides everything you need for simple installation

## Package contents

- Soundbar mounting bracket (2)
- Extension arm (2)
- Installation hardware
- *Installation Guide*

## Parts

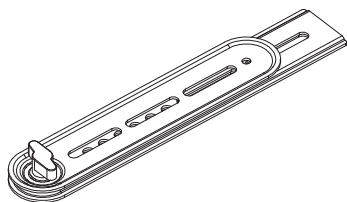



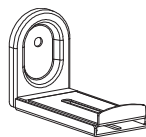

12 - Soundbar mounting bracket (2)



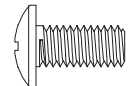

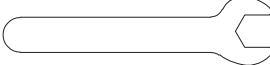

13 - Extension arm (2)



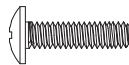
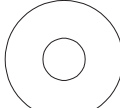

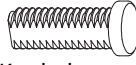

## Installation hardware

Label	Hardware	Quantity	Label	Hardware	Quantity
7	 M6 x 12 screw	2	10	 Hex wrench	1
8	 M6 washer	2	11	 Wrench	1
9	 Anti-skid nut	2			

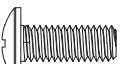
## Soundbar hardware

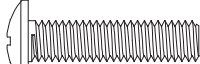
Label	Hardware	Quantity	Label	Hardware	Quantity
1	 M4 x 16 screw	2	4	 M5/M6 washer	4
2	 M5 x 16 screw	2	5	 Key hole screw	2
3	 M6 x 16 screw	2	6	 M6 butterfly nut	2

## TV hardware

Label	Hardware	Quantity	Label	Hardware	Quantity
A	 M6 x 16 screw	4	E	 M5/M6 washer	4
B	 M6 x 25 screw	4	F	 M8 x 10 mm spacer	4
C	 M8 x 25 screw	4	G	 M8 x 2.5 mm spacer	4

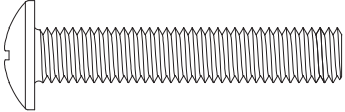
Label	Hardware	Quantity	Label	Hardware	Quantity
D	 M8 x 45 screw	4	H	 M8 plastic gasket	2

## Product dimensions

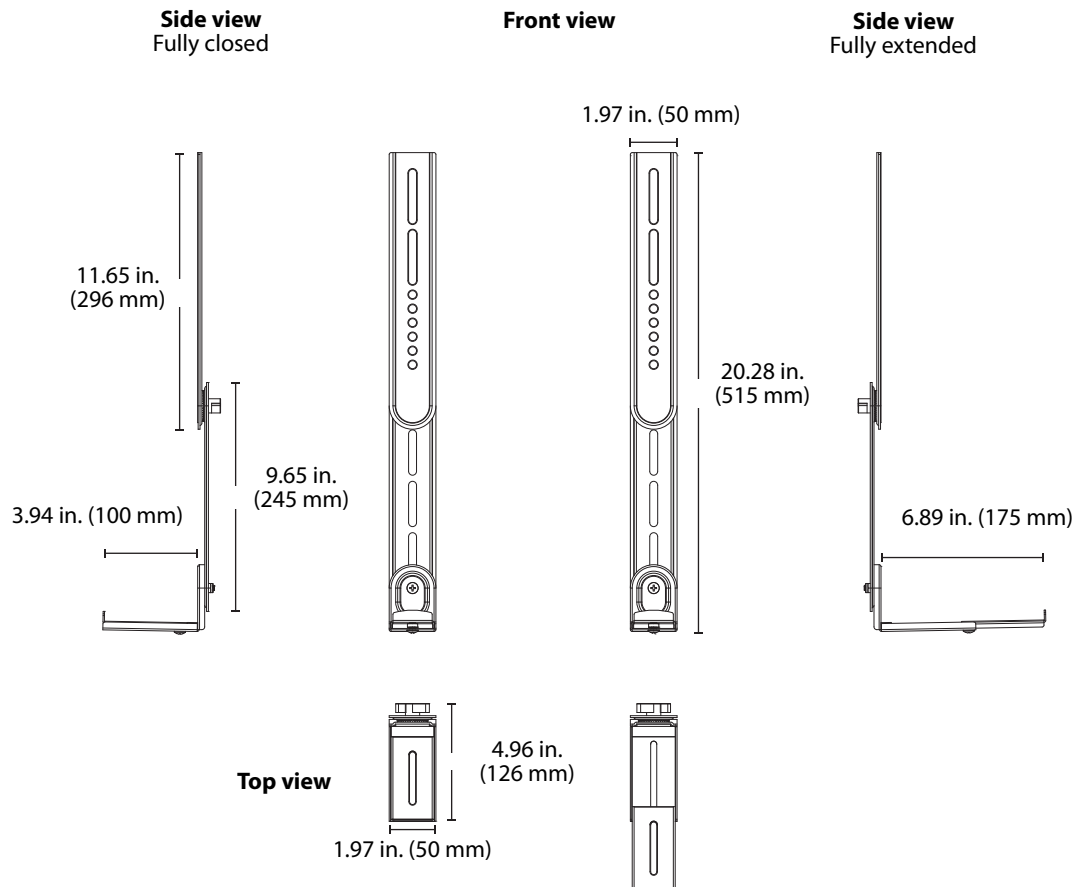

## Tools needed (Not provided)

You will need the following tools to assemble your new soundbar mount:



Tape measure



Bubble level



Phillips head screwdriver

### **WARNING**

This product contains small items that could be a choking hazard if swallowed. Before starting assembly, verify all parts are included and undamaged.

**Note:** Not all hardware will be used.

## Installing your soundbar mount

### Preparing to mount your soundbar

Pay extra attention when fastening the mounting bracket in Step 1 when installing the soundbar onto the bracket. Make sure that you use the appropriate mounting hardware.

- Select the correct mounting hardware according to the screw hole size of your TV. Discard any remaining screws and spacers.
- Carefully lay your TV on its face on a padded, non-abrasive surface, to prevent screen damage.
- Make sure that the brackets are centered and level with each other.
- Do not install this product on a ceiling.

### Step 1: Option 1 - Attaching the brackets to your soundbar using the screw holes on the back of your soundbar

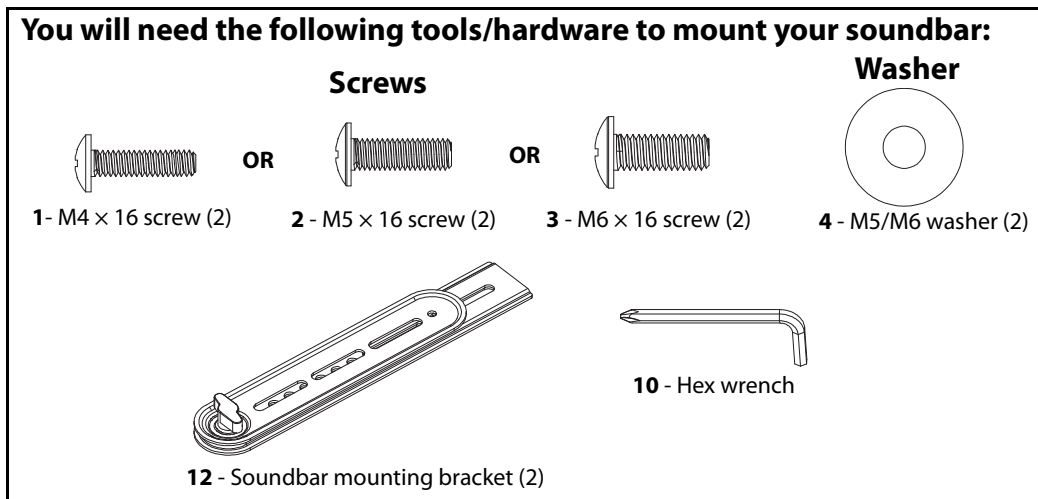

- 1 Loosen the soundbar mounting brackets (12), then adjust the soundbar mounting brackets (12) to fit the mounting holes on the back of your soundbar.

**Note:** Adjust the bracket's installation angle based on your soundbar's length and screw hole width.

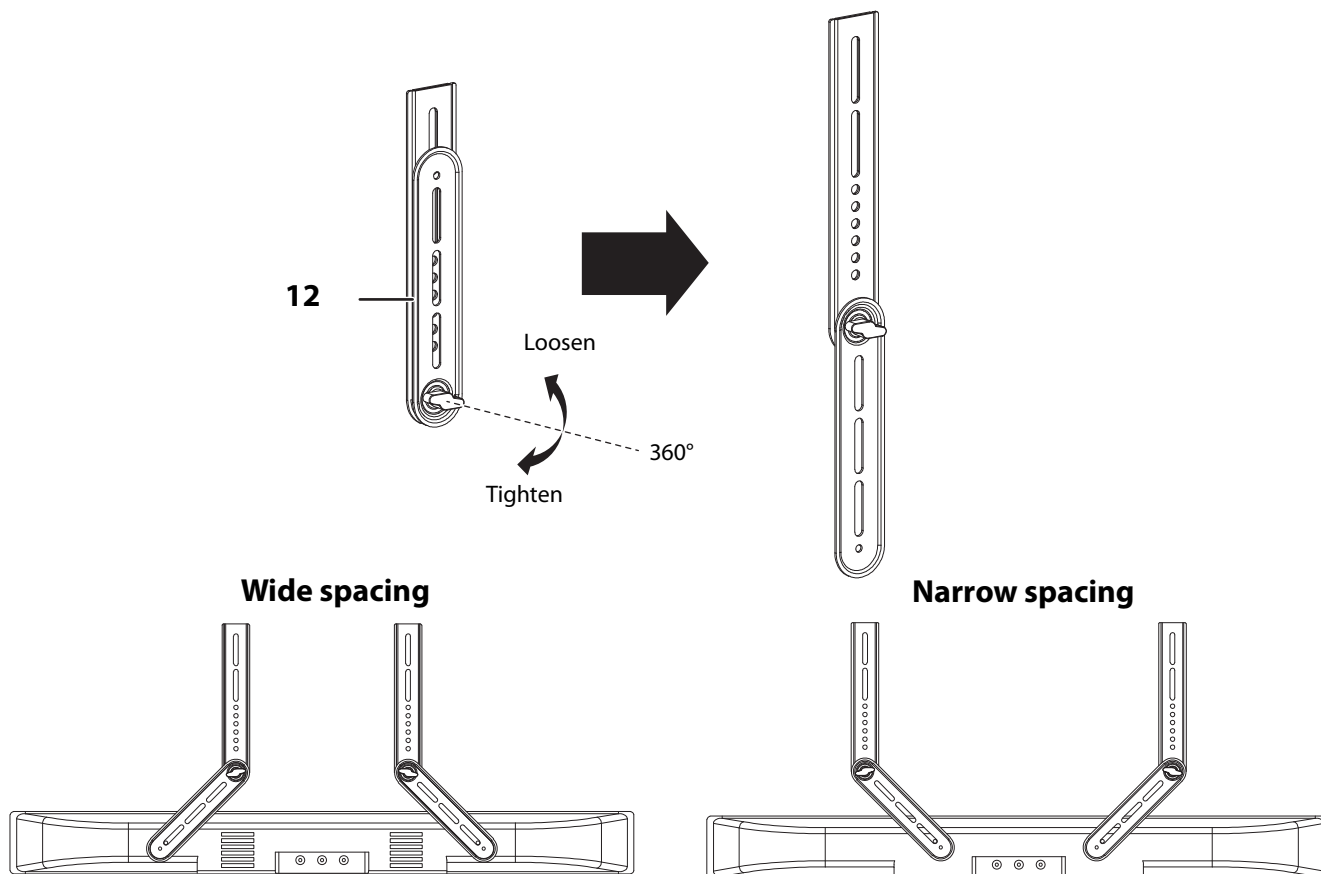

- Secure the soundbar mounting brackets (**12**) to the back of your soundbar with screws (**1, 2, or 3**) and M5/M6 washers (**4**). Tighten with the hex wrench (**10**).

**Tip:** Select the screws that match the screw holes on the back of your soundbar.

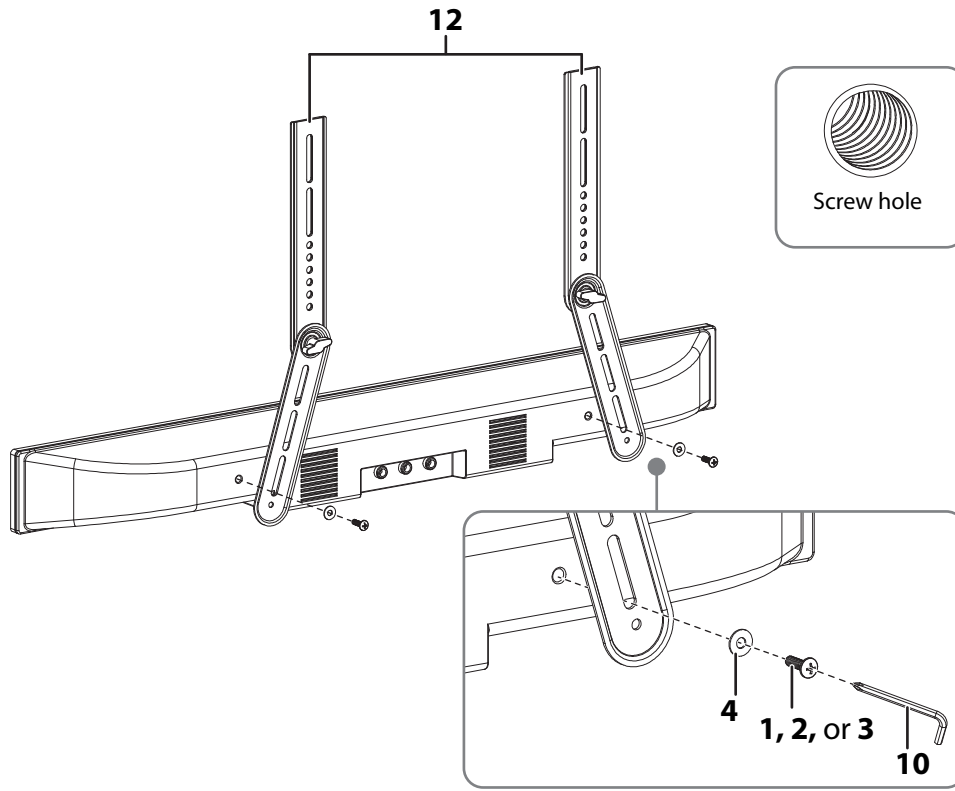

## Step 1: Option 2 - Attaching the brackets to your soundbar using the key holes on the back of your soundbar

You will need the following tools/hardware to mount your soundbar:

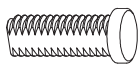

5 - Key hole screw (2)



6 - M6 butterfly nut (2)

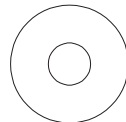

4 - M5/M6 washer (2)

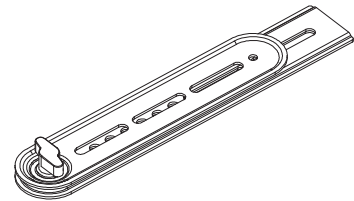

12 - Soundbar mounting bracket (2)

- Insert the key hole screws (**5**) in the key holes on the back of your soundbar.
- Place the soundbar mounting brackets (**12**) over the key hole screws (**5**).
- Place an M5/M6 washer (**4**) over the key hole screws (**5**), then secure with the M6 butterfly nuts (**6**).

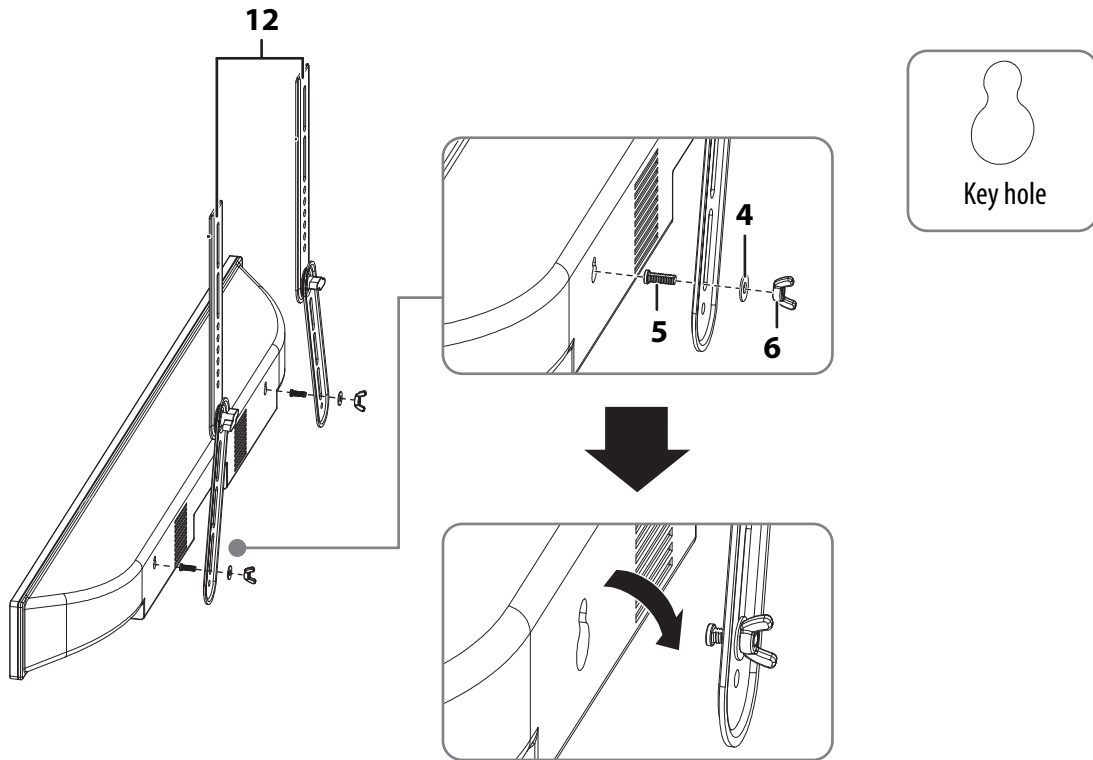

**Step 1: Option 3 - Attaching the brackets with the extension arms to your soundbar using the mounting holes on the bottom of your soundbar**

**You will need the following tools/hardware to mount your soundbar:**

**Screws**

**Washers**

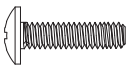

1 - M4 x 16 screw (2)



2 - M5 x 16 screw (2)

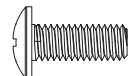

3 - M6 x 16 screw (2)

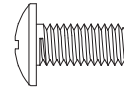

7 - M6 x 12 screw (2)

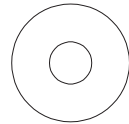

4 - M5/M6 washer (2)



9 - Anti-skid nut (2)

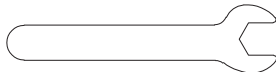

11 - Wrench



Phillips head screwdriver

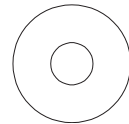

8 - M6 washer (2)

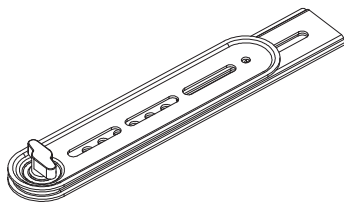

12 - Soundbar mounting bracket (2)

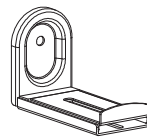

13 - Extension arm (2)

- 1** Using a wrench (**11**) and Phillips head screwdriver, attach the extension arms (**13**) to the soundbar mounting brackets (**12**) with an M6 × 12 screw (**7**) and M6 washer (**8**), and anti-skid nut (**9**).

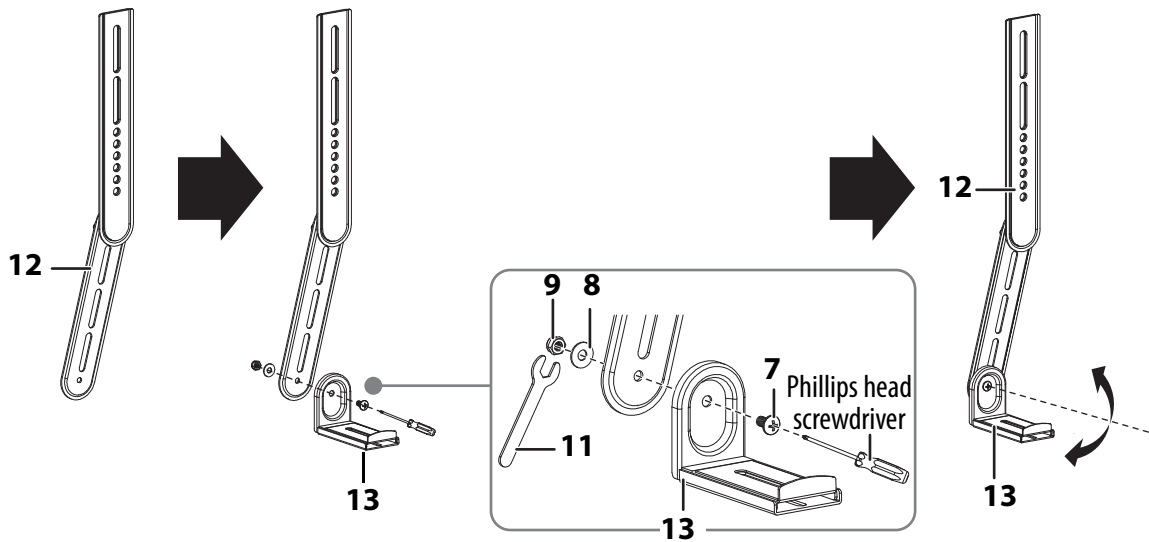

- 2** Using a Phillips head screwdriver, adjust the extension arms (**13**) to fit the bottom of your sound bar.

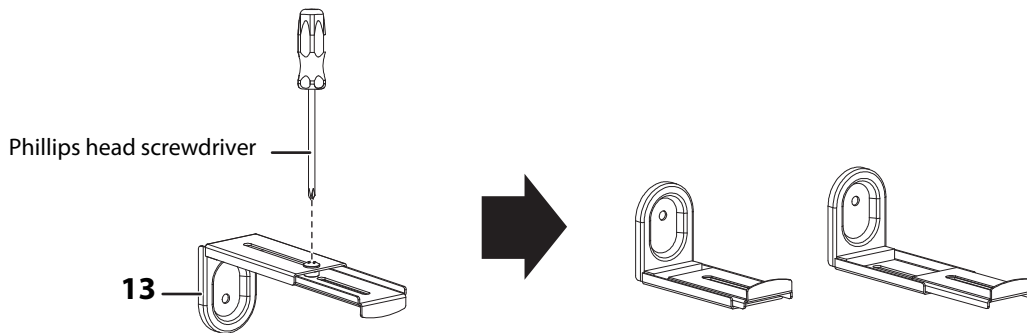

- 3** Using a Phillips head screwdriver, mount the bracket assembly (**A**) onto the bottom of your soundbar.

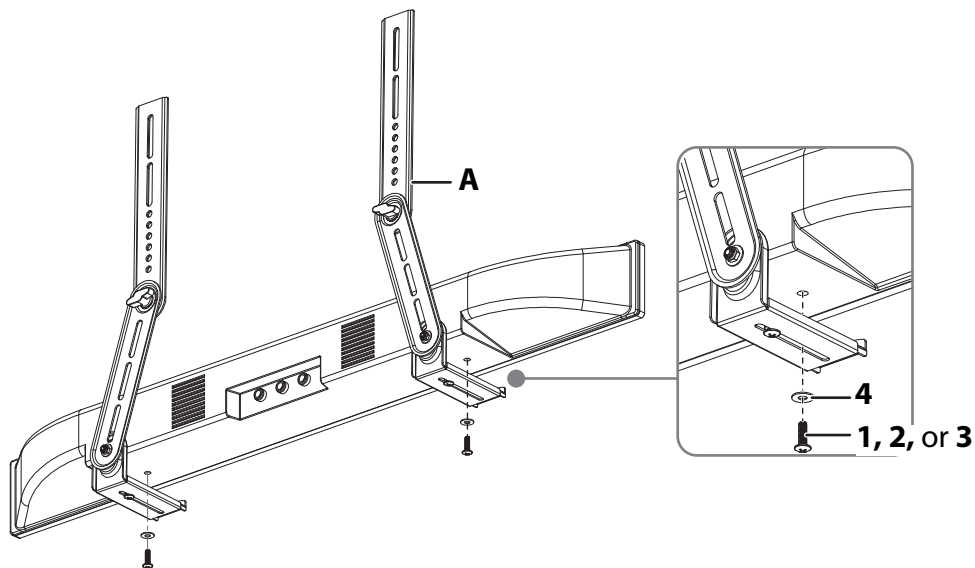

## Step 2: Installing the bracket assembly/soundbar to your TV mount

**Note:** Make sure that the minimum distance between the TV mount and the wall is greater than 1 in. (2.54 cm).

You will need the following tools/hardware to mount your soundbar:

### Screws

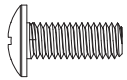

A - M6 x 16 screw (4)

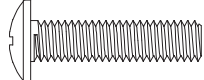

B - M6 x 25 screw (4)

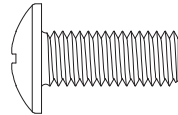

C - M8 x 25 screw (4)

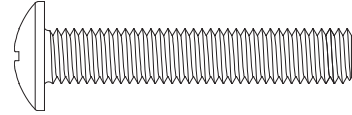

D - M8 x 45 screw (4)

### Spacers

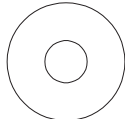

E - M5/M6 Washer (4)

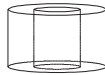

F - M8 x 10 mm spacer (4)



G - M8 x 2.5 mm spacer (4)



H - M8 Plastic gasket (2)



Phillips head screwdriver

### Assembly options (for reference)

#### Above TV

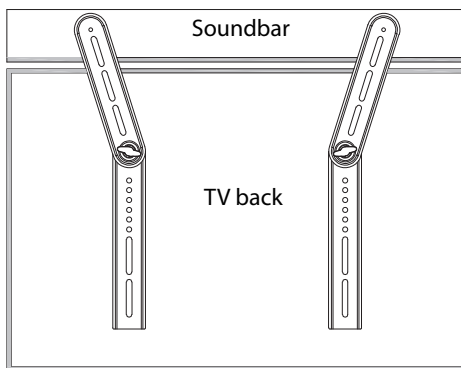

#### Below TV

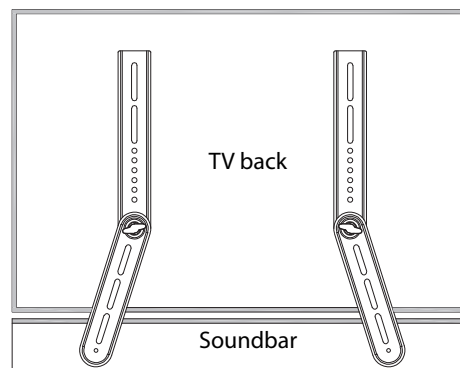

### Screw selection

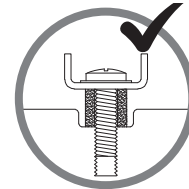
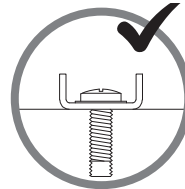
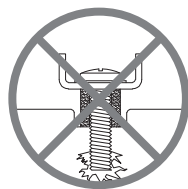
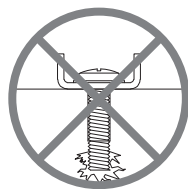
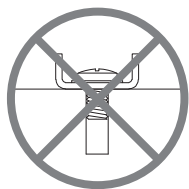

## 1 Remove your TV mount from your TV.

**Note:** We recommend that you have two people for this step.

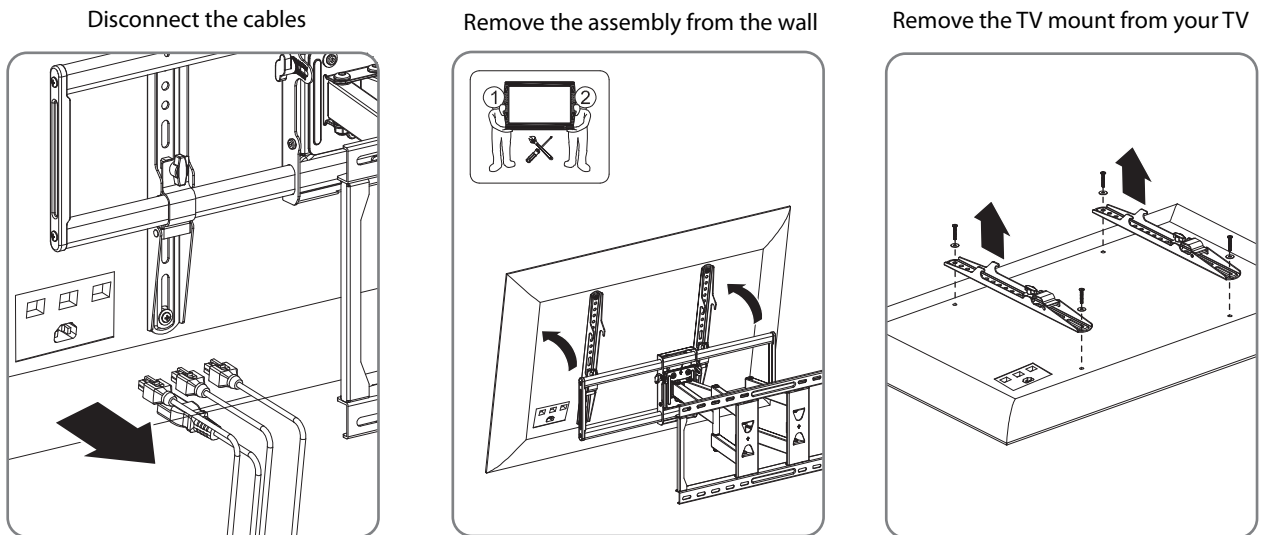

## 2 Attach the assembled soundbar and brackets to the back of your TV.

**Note:** When mounting, make sure that the mounting brackets are centered and level under your TV.

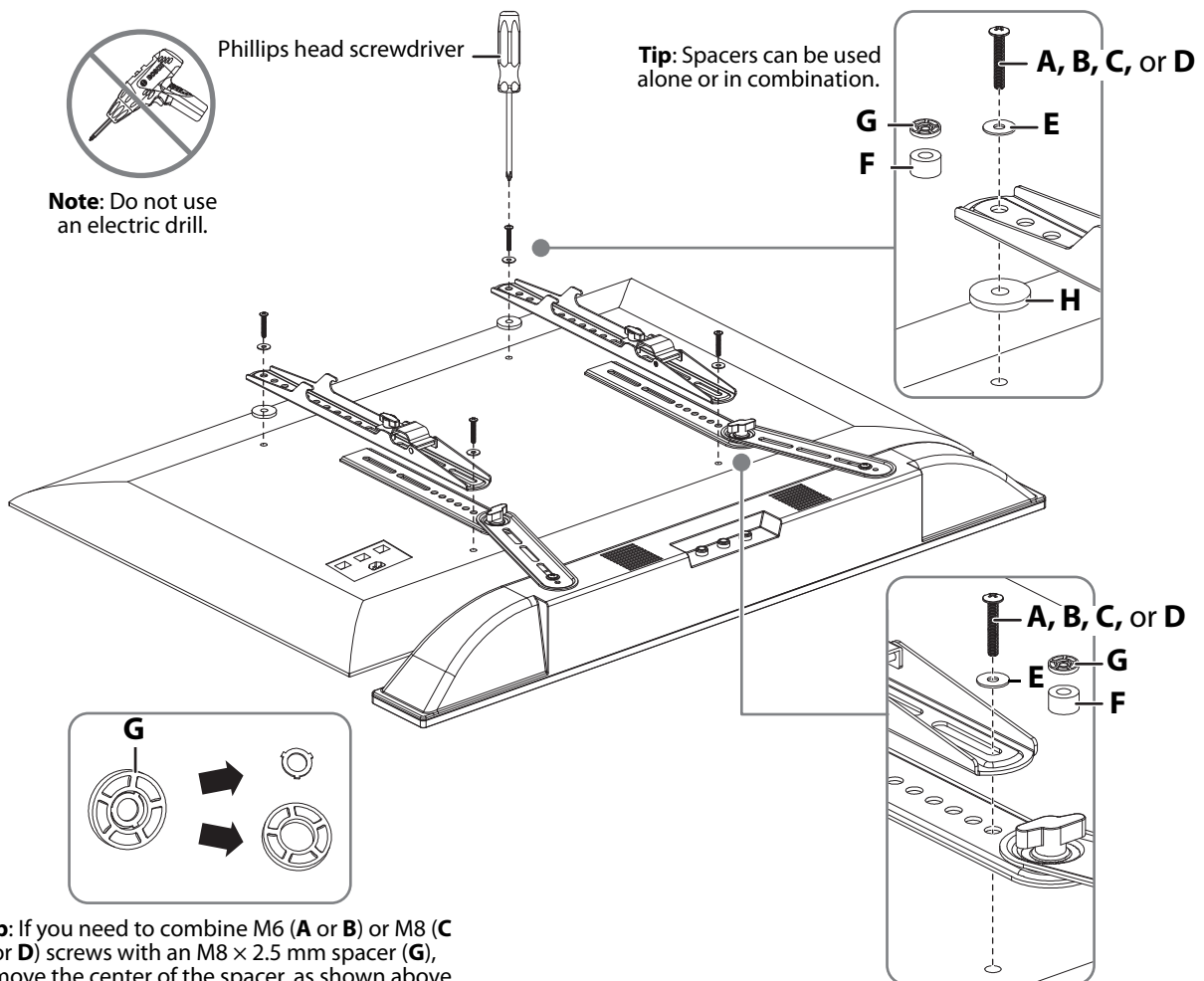

3 Rehang the assembled unit on the TV wall mount.

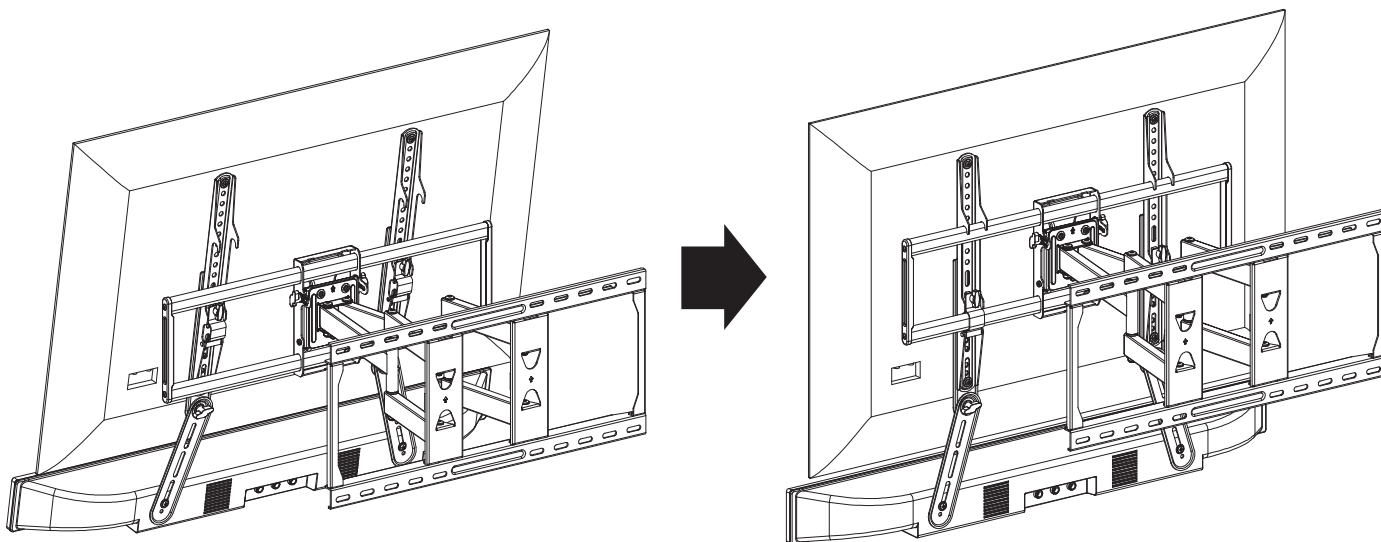

## Specifications

Dimensions (H x W x D)	20.28 x 1.97 x 3.94–6.89 in. (51.5 x 5 x 10-17.5 cm)
Maximum capacity	15 lbs. (6.8 kg)
Weight	<b>Net:</b> 3.21 lbs. (1.46 kg) <b>Gross:</b> 3.67 lbs. (1.67 kg)
Color	Black

## ONE-YEAR LIMITED WARRANTY

Best Buy, or its Authorized Partner of Insignia branded products, warrants to you, the original purchaser of this new Insignia branded product ("Product"), that the Product shall be free of defects in the original manufacture of the material or workmanship for a period of one (1) year from the date of your purchase of the Product or the date of delivery (if later than the date of purchase) ("Warranty Period").

For this warranty to apply, your Product must be (i) purchased in the United States or Canada from a Best Buy branded retail store, online at [www.bestbuy.com](http://www.bestbuy.com) or [www.bestbuy.ca](http://www.bestbuy.ca), or from Best Buy's Authorized Partner, and (ii) packaged or sold with this warranty statement.

The term "Best Buy", as used in this warranty, refers to Best Buy branded retail stores, [www.bestbuy.com](http://www.bestbuy.com), [www.bestbuy.ca](http://www.bestbuy.ca), and Best Buy's Authorized Partner.

Because Insignia cannot control the quality of products sold by unauthorized sellers, this warranty applies only to Products that were purchased from Best Buy or an Insignia Authorized Partner, unless otherwise prohibited by law. Insignia reserves the right to reject warranty claims for Products purchased from unauthorized sellers, including unauthorized websites.

REPAIR OR REPLACEMENT, AS PROVIDED UNDER THIS WARRANTY, IS YOUR EXCLUSIVE REMEDY FOR BREACH OF WARRANTY. INSIGNIA SHALL NOT BE LIABLE FOR ANY INCIDENTAL OR CONSEQUENTIAL DAMAGES FOR THE BREACH OF ANY EXPRESSED OR IMPLIED WARRANTY ON THIS PRODUCT, INCLUDING, BUT NOT LIMITED TO, LOST DATA, LOSS OF USE OF YOUR PRODUCT, LOST BUSINESS, OR LOST PROFITS. INSIGNIA PRODUCTS MAKES NO OTHER EXPRESS WARRANTIES WITH RESPECT TO THE PRODUCT. ALL EXPRESSED AND IMPLIED WARRANTIES FOR THE PRODUCT, INCLUDING BUT NOT LIMITED TO ANY IMPLIED WARRANTIES OF AND CONDITIONS OF MERCHANTABILITY AND FITNESS FOR A PARTICULAR PURPOSE, ARE LIMITED IN DURATION TO THE WARRANTY PERIOD SET FORTH ABOVE AND NO WARRANTIES, WHETHER EXPRESSED OR IMPLIED, WILL APPLY AFTER THE WARRANTY PERIOD. SOME STATES, PROVINCES, AND JURISDICTIONS DO NOT ALLOW LIMITATIONS ON (i) HOW LONG AN IMPLIED WARRANTY LASTS, (ii) EXCLUSION OR LIMITATION OF INCIDENTAL OR CONSEQUENTIAL DAMAGES, or (iii) LIMITATION OF INCIDENTAL OR CONSEQUENTIAL DAMAGES, SO THE ABOVE LIMITATIONS OR EXCLUSIONS MAY NOT APPLY TO YOU. THIS WARRANTY GIVES YOU SPECIFIC LEGAL RIGHTS, AND YOU MAY ALSO HAVE OTHER RIGHTS, WHICH VARY FROM STATE TO STATE OR PROVINCE TO PROVINCE.

### How long does the coverage last?

The Warranty Period lasts for 1 year (365 days) from the date you purchased the Product or the date of delivery (if later than the date of purchase). Your purchase date is printed on the receipt you received with the Product. In the event that Authorized Partner ceases to sell the covered Insignia branded product, this warranty shall terminate for that product and there shall be no repair or replacement of the Product.

### What does this warranty cover?

During the Warranty Period, if the original manufacture of the material or workmanship of the Product is determined to be defective by an authorized Insignia repair center or store personnel, Insignia will (at its sole option): (1) repair the Product with new or rebuilt parts; or (2) replace the Product at no charge with new or rebuilt comparable products or parts. Products and parts replaced under this warranty become the property of Insignia and are not returned to you. If service of Products or parts are required after the Warranty Period expires, you must pay all labor and parts charges. This warranty lasts as long as you own your Insignia Product during the Warranty Period. Warranty coverage terminates if you sell or otherwise transfer the Product.

### How to obtain warranty service?

If you purchased the Product at a Best Buy retail store location or from a Best Buy online website ([www.bestbuy.com](http://www.bestbuy.com) or [www.bestbuy.ca](http://www.bestbuy.ca)), please take your original receipt and the Product to any Best Buy store. Make sure that you place the Product in its original packaging or packaging that provides the same amount of protection as the original packaging. If you purchased your Product from an Authorized Partner, call Insignia at 1-877-467-4289.

To obtain warranty service, in the United States and Canada call 1-877-467-4289. Call agents may diagnose and correct the issue over the phone.

If you purchased the Product from an Authorized Partner other than Best Buy, please call 1-888-BESTBUY in the United States or 1-866-BESTBUY in Canada. You will be asked to provide proof of purchase and to return your Product to Best Buy. Make sure that you put the Product in its original packaging or packaging that provides the same amount of protection as the original packaging.

### Where is the warranty valid?

This warranty is valid only in the United States and Canada to the original purchaser of the product from an Authorized Partner, in the country where the original purchase was made.

### What does the warranty not cover?

- Food, beverage, and/or medicine loss/spoilage.
- Damage to other products caused by a power surge or other similar issue while connected to the Product.
- Customer instruction/education.
- Installation.
- Set up adjustments.
- Cosmetic damage.
- Damage due to weather, lightning, and other acts of God, such as power surges.
- Accidental damage.
- Misuse.
- Abuse.
- Negligence.
- Commercial purposes/use, including but not limited to use in a place of business or in communal areas of a multiple dwelling condominium or apartment complex, or otherwise used in a place of other than a private home.
- Modification of any part of the Product, including the antenna.
- Display panel damaged by static (non-moving) images applied for lengthy periods (burn-in).
- Damage due to incorrect operation or maintenance.
- Connection to an incorrect voltage or power supply.
- Damage due to attempted repair by any person not authorized by Insignia to service the Product.
- Products sold "as is" or "with all faults".
- Consumables, including but not limited to batteries (i.e. AA, AAA, C etc.).
- Products where the factory applied serial number has been altered or removed.
- Loss or Theft of this product or any part of the product.
- Display panels containing up to three (3) pixel failures (dots that are dark or incorrectly illuminated) grouped in an area smaller than one tenth (1/10) of the display size or up to five (5) pixel failures throughout the display. (Pixel based displays may contain a limited number of pixels that may not function normally.)
- Failures or Damage caused by any contact including but not limited to liquids, gels or pastes.

1-877-467-4289 | [www.insigniaproducts.com](http://www.insigniaproducts.com)

INSIGNIA is a trademark of Best Buy and its affiliated companies.

Distributed by Best Buy Purchasing, LLC

Richfield, MN 55423 U.S.A

©2025 Best Buy. All rights reserved.

INSIGNIA™

**For product inquiries, please contact us with the information below:**

**1-877-467-4289**

**[www.insigniaproducts.com](http://www.insigniaproducts.com)**



INSIGNIA is a trademark of Best Buy and its affiliated companies.  
Distributed by Best Buy Purchasing, LLC  
7601 Penn Ave South, Richfield, MN 55423 U.S.A.  
©2025 Best Buy. All rights reserved.

V1 ENGLISH  
25-0734