

INSTALLATION INSTRUCTIONS

Preview Installation Order

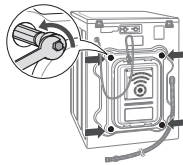

Checking and choosing the proper location



Unpacking and removing shipping bolts

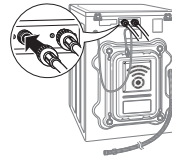

Connecting the water line



Connecting the drain line



Leveling the washing machine

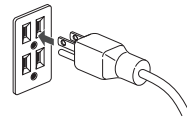

Plugging in the power cord and grounding



Test run

⚠ WARNING

- **Washer is heavy!** Two or more people are required when moving and unpacking the washer. Failure to follow this warning can result in back or other injury.
- **Store and install the washer where it will not be exposed to temperatures below freezing or exposed to outdoor weather conditions.** Failure to follow this warning can cause serious injury, fire, electric shock, or death.
- **Properly ground washer to conform with all governing codes and ordinances.** Failure to follow this warning can cause serious injury, fire, electric shock, or death.
- **To reduce the risk of electric shock, do not install the washer in humid spaces.** Failure to follow this warning can cause serious injury, fire, electric shock, or death.
- **The base opening must not be obstructed by carpeting when the washer is installed on a carpeted floor.**
- **Do not remove ground prong. Do not use an adapter or extension cord. Plug into a grounded 3-prong outlet.** Failure to follow this warning can cause serious injury, fire, electric shock, or death.
- **Certain internal parts are intentionally not grounded and may present a risk of electric shock only during servicing. Service personnel - Do not contact the following parts while the appliance is energized: pump, valve, motor, control board.**

Checking and Choosing the Proper Location

Install the washing machine on a solid floor that is strong and rigid enough to support the weight of the washing machine, even when fully loaded, without flexing or bouncing. If the floor has too much flex, you may need to reinforce it to make it more rigid. If the floor is not solid, it may cause severe vibration and noise.

- 1 Clean the floor before installation.
 - Make sure to select solid and smooth ground.
- 2 Two or more people are needed for moving and unpacking the washing machine.
- 3 Allow for sufficient space between the walls and the washing machine for installation.

Space requirements

You must allow sufficient space for water lines, the drain line, and airflow.

NOTE

- Be sure to allow for wall, door, or floor moldings that may increase the required clearances.

Installing on a floor

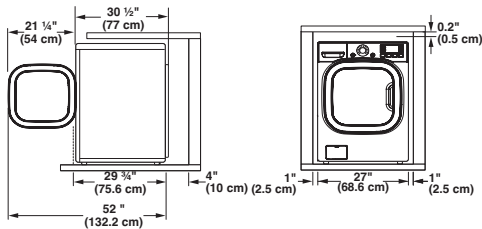

NOTE

- The floor must be strong and rigid enough to support the weight of the washer, when fully loaded, without flexing or bouncing. If your floor has too much flex, you may need to reinforce it to make it more rigid.
 - A floor that is adequate for a top-loading washer may not be rigid enough for a front loading washer, due to the difference in the spin speed and direction. If the floor is not solid, your washer may vibrate and you may hear and feel the vibration throughout your house.
- Before installing the washer, make sure the floor is clean, dry and free of dust, dirt, water and oils so the washer feet can not slide easily. Leveling feet that can move or slide on the floor can contribute to excess vibration and noise due to poor contact with the floor.
- If a drip pan must be used, take extra care to follow the instructions provided with the drip pan and make sure the leveling feet are adjusted for firm and even contact with the pan. Use of drip pans and failure to properly level the machine may result in increased vibration and noise during operation.

Installing on a pedestal or stacking kit

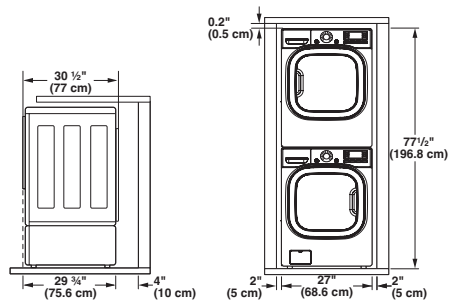

NOTE

- Refer to the instructions packaged with the optional PEDESTAL or STACKING KIT before installing with a PEDESTAL or a STACKING KIT.

Unpacking and Removing Shipping Bolts

When removing the washer from the carton base, be sure to remove the foam drum support in the middle of the carton base. If you must lay the washer down to remove the base packaging materials, always lay it carefully on its side. Do not lay the washer on its front or back.

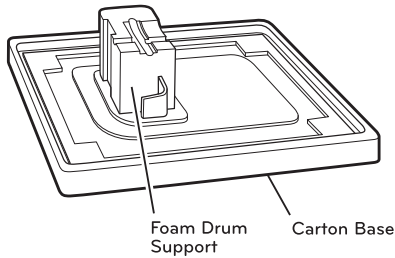

- 1 Remove the bottom two shipping bolts with the wrench (included). Fully loosen all four shipping bolts by turning them counterclockwise, and then pull them out.

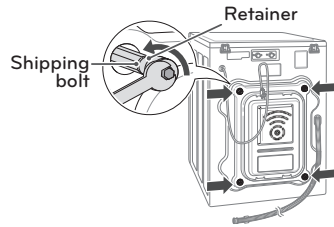

- 2 Locate the four hole caps included in the accessory pack and install them in the shipping bolt holes.

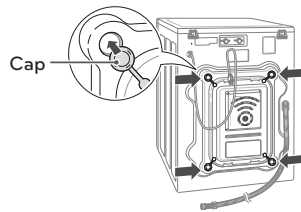

NOTE

- Save the bolt assemblies for future use. To prevent damage to internal components, do not transport the washer without reinstalling the shipping bolts.
- Failure to remove shipping bolts and retainers may cause severe vibration and noise, which can lead to permanent damage to the washer. The cord is secured to the back of the washer with a shipping bolt to help prevent operation with shipping bolts in place.

Connecting the Water Lines

- 1 Check the rubber seals on both sides of the hose.
- Insert a rubber seal into the threaded fittings on each hose to prevent leaking.

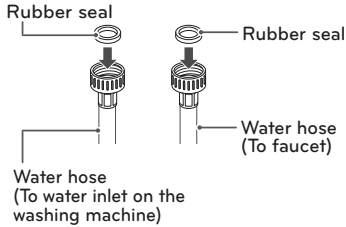

- 2 Connect the water supply hoses to the HOT and COLD water faucets tightly by hand and then tighten another 2/3 turn with pliers.
- Connect the blue hose to a cold water faucet and the red hose to a hot water faucet.

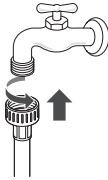

⚠ WARNING

- Do not overtighten. Damage to the coupling can result.

- 3 After connecting the inlet hoses to the water faucets, turn on the water faucets to flush out foreign substances (dirt, sand or sawdust) in the water lines. Let the water drain into a bucket, and check the water temperature.

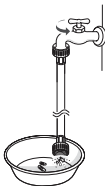

- 4 Connect the hoses to the water inlets tightly by hand and then tighten another 2/3 turn with pliers.
- Connect the blue hose to the cold water inlet and the red hose to the hot water inlet.

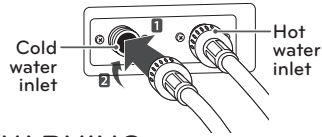

⚠ WARNING

- Do not overtighten the hoses. Overtightening can damage the valves resulting in leaking and property damage.

- 5 Check for leaks by turning on the faucets.
- If water leaks, check steps 1 to 4 again.

ⓘ NOTE

- For your safety, and for extended Product life, we recommend using high-quality LG components. LG is Not responsible for product Malfunction or damage caused by the use of separately purchased Non-LG parts.
- Use new hoses when installing the washing machine. Do not reuse old hoses.
- Contact LG Customer Service for Assistance in buying hoses : 1-800-243-0000.
- Periodically check the hoses for cracks, leaks and wear, and replace the hoses every 5 years. Do not stretch the water hoses intentionally, and make sure that they are not crushed by other objects.
- Water supply pressure must be between 20 psi and 120 psi (138 – 827 kPA). If the Water supply pressure is more than 120 psi, a Pressure reducing valve must be installed.
- To provide optimum washing performance the hot water temperature should be set at 120 – 135°C (48-57°C) and the cold at 60°C (15°C).

Connecting the Drain Line

Secure the drain hose in place to prevent moving and leaking.

NOTE

- The drain hose should be properly secured. Failure to properly secure the drain hose can result in flooding and malfunction.
- Total height of the hose end should not exceed 96 inches (244.8 cm) from the bottom of the washer.
- The drain must be installed in accordance with any applicable local codes and regulations.
- Make sure that the water lines are not stretched, pinched, crushed, or kinked.

Using a standpipe

- 1 Clip the end of the hose into the elbow bracket.
 - Connect the elbow bracket within 4 inches (10 cm) of the end of the drain hose. If the drain hose is extended more than 4 inches (10 cm) beyond the end of the elbow bracket, mold or microorganisms could spread to the inside of the washer.

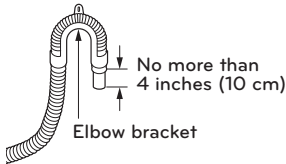

- 2 Insert the end of the drain hose into the standpipe.

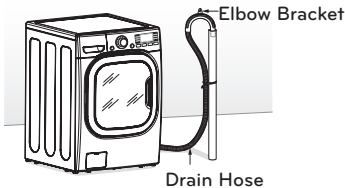

- 3 Use a tie strap to secure the drain hose in place.

Using a laundry tub

- 1 Clip the end of the hose into the elbow bracket.
 - Connect the elbow bracket within 4 inches (10 cm) of the end of the drain hose. If the drain hose is extended more than 4 inches (10 cm) beyond the end of the elbow bracket, mold or microorganisms could spread to the inside of the washer.

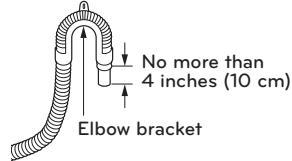

- 2 Hang the end of the drain hose over the side of the laundry tub.

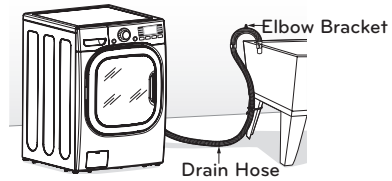

- 3 Use a tie strap to secure the drain hose in place.

Leveling the Washing Machine

The washer tub of your new washing machine spins at very high speeds. To minimize vibration, noise, and unwanted movement, the floor must be perfectly level and solid.

- 1 Check that the washing machine is level.
 - Ensure it is level by rocking the top edges of the washing machine or placing a level on the washing machine. The slope beneath the washing machine must not exceed 1°, and all four leveling feet must rest firmly on the floor.

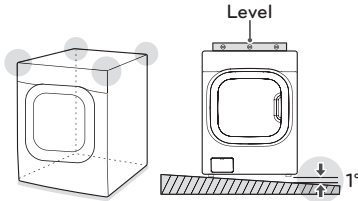

- 2 Turn the lower leveling feet clockwise to level the washing machine.
 - Turning the lower leveling feet clockwise raises the washing machine.

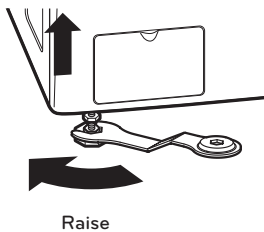

- 3 Turn the locknuts counterclockwise and tighten them when the washing machine is level.

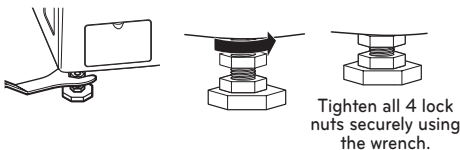

- 4 Check again to make sure the machine is level.
 - Push or rock the top edges of the washing machine gently to make sure that the washing machine does not rock.
 - If the washing machine rocks, repeat steps 1 to 3.

⚠ WARNING

- Using the washing machine without leveling, it may result in malfunction caused by the production of excess vibration and noise.
- If you are installing the washing machine on the optional pedestal, you must adjust the leveling feet on the pedestal to level the washing machine. The washing machine's leveling feet should be minimized and the locknuts turned counterclockwise to secure them.
- Use the leveling feet only when you level the washing machine. If you raise the leveling feet unnecessarily, it may cause abnormal vibration of the washing machine.

Using non-skid pads (optional)

If you install the washing machine on a slippery surface, it may move because of excessive vibration. Incorrect leveling may cause malfunction through noise and vibration. If this occurs, lay the non-skid pads under the leveling feet and adjust the level.

- 1 Clean the floor to attach the non-skid pads.
 - Use a dry rag to remove and clean foreign objects or moisture. If moisture remains, the non-skid pads may slip.
- 2 Adjust the level after placing the washing machine in the installation area.
- 3 Place the adhesive side of the non-skid pad on the floor.
 - It is most effective to install the non-skid pads under the front legs. If it is hard to place the pads under the front legs, place them under the back legs.

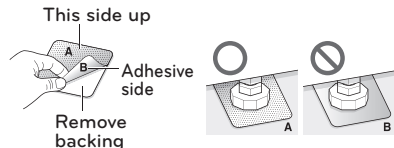

- 4 Check the washing machine's level again.
 - Push or rock the top edges of the washing machine gently to make sure that the washing machine does not rock. If the washing machine rocks, level the washing machine again.

Plugging in the Power Cord and Grounding

Make sure to ground the washing machine to prevent a short circuit or an electric shock when plugging in.

Using a 3-prong outlet

If plugged into a grounded, 3-prong outlet rated for use with this appliance, no further grounding is necessary.

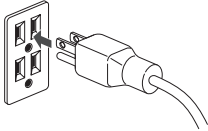

⚠ WARNING

- The power outlet must be within 60 inches (1.5 m) of either side of the washer.
- The appliance and outlet must be positioned so that the plug is easily accessible.
- Do not overload the outlet with more than one appliance.
- The outlet must be grounded in accordance with current wiring codes and regulations.
- Time-delay fuse or circuit breaker is recommended.
- It is the personal responsibility and obligation of the product owner to have a proper outlet installed by a qualified electrician.
- Do not use a worn or damaged power cord or power plug. Replace or repair worn or damages cords or plugs it immediately. Failure to do so may result in death, fire, electric shock, or malfunction.
- Do not modify the power cord and take care not to damage it when installing or moving the washing machine. Failure to follow this warning may result in death, fire, electric shock, or malfunction.
- Make sure that the washing machine is grounded.
- Connect this washing machine to a grounded outlet conforming to the rating prior to use. Failure to do so may result in fire, electric shock, or malfunction.
- Do not use adaptors or extension cords. The washing machine should always be plugged into its own individual electrical outlet which has a voltage rating that matches the rating plate. Failure to do so may result in fire, electric shock or malfunction.
- Do not damage or cut off the ground prong of the power cord. Doing so may cause death, fire, electric shock, or product malfunction.

Test run

Check if the washing machine is properly installed and run a test cycle.

- 1 Load the washing machine with 6 pounds of laundry (approximately 14 shirts).
- 2 Press the Power button and turn the cycle selector knob to the right.
- 3 Press the Rinse+Spin button to select Rinse+Spin.
- 4 Press the Start/Pause button.
 - The wash cycle starts.
- 5 Check if water is supplied, that the washing machine does not rock or vibrate excessively, and that it drains well during the spin cycle.
 - If water leaks during water supply, see page 14, Connecting the water lines, to connect them properly.
 - If the washing machine rocks and vibrates excessively, see page 16, Leveling the washing machine, to level it again.
 - If the drain does not work, see page 15, Connecting the drain line, to install it properly.