

INSIGNIA™

USER GUIDE

12-Cycle Electric and Gas Dryers

NS-TDRE67W1/NS-TDRG67W1/NS-TDRE67W1-C

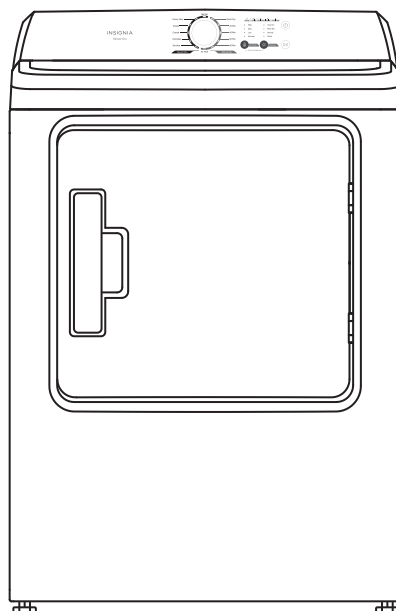

Before using your new product, please read these instructions to prevent any damage.

Contents

Introduction	3
IMPORTANT SAFETY INSTRUCTIONS	3
Features	7
Package contents	7
Front components	7
Back components	8
Control panel	9
Unpacking your dryer	10
Choosing a location	11
Exhausting requirements	16
Duct requirements	17
Electric requirements	18
Gas requirements	20
Grounding requirements	21
Changing the dryer vent location (optional)	22
Installing your dryer	25
Tools you will need	25
Materials you will need	25
Before you start	25
Step-by-step instructions	26
Reversing the dryer door	32
Using your dryer	35
Drying a load of clothes	35
Unloading your dryer	36
Cleaning the lint filter	36
Dryer options and settings	37
Special laundry tips	39
Fabric Care Chart	40
Maintaining your dryer	41
Cleaning the exterior	41
Cleaning the drum	41
Cleaning the control panel	41
Cleaning and inspecting the exhaust system	41
Troubleshooting	42
Understanding the error codes	44
Specifications	44
ONE-YEAR LIMITED WARRANTY	45

Introduction

Congratulations on the purchase of your new Insignia dryer. Insignia dryers feature the latest in design and capabilities and will provide reliable and trouble-free performance.

IMPORTANT SAFETY INSTRUCTIONS

READ AND KEEP THESE INSTRUCTIONS FOR FUTURE REFERENCE

This manual contains important information on the installation, use, and care of your appliance. Please read this manual carefully before installation and operation of this machine to prevent injury and property damage.

Warnings and Important Safety Instructions in this manual DO NOT cover all possible conditions and situations that may occur. It is your responsibility to use common sense, caution, and care when installing, maintaining, and operating your dryer.

DRYER SAFETY

YOUR SAFETY AND THE SAFETY OF OTHERS ARE VERY IMPORTANT

To prevent injury to the user or other people and property damage, the instructions shown here must be followed. Incorrect operation due to ignoring of instructions may cause harm or damage, including death.

The level of risk is shown by the following indications.



WARNING

This symbol indicates the possibility of death or serious injury.



CAUTION

This symbol indicates the possibility of injury or damage to property.



WARNING

This symbol indicates the possibility of dangerous voltage constituting a risk of electrical shock is present that could result in death or serious injury.



WARNING

For your safety the information in this manual must be followed to minimize the risk of fire or explosion, or to prevent property damage, personal injury, or death.

- Do not store or use gasoline or other flammable vapors and liquids in the vicinity of this or any other appliance.
- Installation and service must be performed by a qualified installer, service agency, or the gas supplier.



WARNING

Fire Hazard

- Failure to follow safety warnings exactly could result in serious injury, death, or property damage.
- Do not install a booster fan in the exhaust duct.
- Install all clothes dryers in accordance with the installation instructions of the manufacturer of the dryer.



WARNING

What to do if you smell gas

- Do not try to light any appliance.
- Do not touch any electrical switch. Do not use any phone in your building.
- Clear the room, building, or area of all occupants.
- Immediately call your gas supplier from a neighbor's phone. Follow the gas supplier's instructions.
- If you cannot reach your gas supplier, call the fire department.



WARNING

To reduce the risk of fire, electric shock, or injury to persons when using your appliance, follow basic precautions, including the following:

- Read all instructions before using the appliance.
- Use this appliance only for its intended purpose as described in this *User Guide*.
- Before use, the dryer must be properly installed as described in this *User Guide*.
- ALWAYS follow the fabric care instructions supplied by the garment manufacturer.
- Do not dry articles that have been previously cleaned in, washed in, soaked in, or spotted with gasoline, dry-cleaning solvents, other flammable or explosive substances as they give off vapors that could ignite or explode.
- Do not use the dryer to dry clothes which have traces of any flammable substance, such as vegetable oil, cooking oil, machine oil, flammable chemicals, thinner, etc., or anything containing wax or chemicals, such as mops and cleaning clothes. Flammable substances may cause the fabric to catch fire by itself.
- Do not store or use gasoline or other flammable vapors and liquids near this or any other appliance.
- Do not allow children to play on or in the appliance. Close supervision of children is necessary when the appliance is used near children.
- Before the appliance is removed from service or discarded, remove the door of the drying compartment.
- Do not reach into the appliance if the drum is moving.
- Do not install or store this appliance where it will be exposed to the weather or freezing temperatures below 33° F.
- Do not tamper with the controls and latch.
- Do not install a booster fan in the exhaust duct.
- Do not repair or replace any part of the appliance or attempt any servicing unless it is specifically recommended in the user maintenance instructions or in published user-repair instructions that you understand and have the skills to carry out.
- Keep the area underneath and around your appliances free of combustible materials (lint, paper, rags, etc.), gasoline, chemicals, and other flammable vapors and liquids.
- Do not place items exposed to cooking oils in your dryer. Items contaminated with cooking oils may contribute to a chemical reaction that could cause a load to catch fire. To reduce the risk of fire due to contaminated loads, the final part of a tumble dryer cycle occurs without heat (cool down period). Avoid stopping a tumble dryer before the end of the drying cycle unless all items are quickly removed and spread out so that the heat is dissipated.
- Unplug the dryer if the machine is to be left for an extended period of time, such as during vacations
- Packaging material can be dangerous for children. There is a risk of suffocation! Keep all packaging from children.
- Always check the inside of the dryer for foreign objects before loading laundry. Keep the door closed when not in use.
- Do not use fabric softeners or products to eliminate static unless recommended by the manufacturer of the fabric softener or product manufacture.

- **Clean the lint screen before or after each load.**
- Keep the area around the exhaust opening and surrounding areas free from lint, dust, and dirt.
- The interior of the dryer and exhaust duct should be cleaned periodically by qualified service personnel.
- Do not place items exposed to cooking oils in your dryer. Items contaminated with cooking oils may contribute to a chemical reaction that could cause a load to catch fire.
- This appliance must be grounded. See “[Electric requirements](#)” on page 18 and “[Grounding requirements](#)” on page 21.
- This appliance must be properly grounded. Never plug the power cord into a receptacle that is not grounded adequately and in accordance with local and national codes. Refer to installation instructions for grounding this appliance.
- Ensure pockets are free from small irregularly shaped hard objects and foreign material, i.e. coins, knives, pins, etc. These objects could damage your dryer.
- Do not use heat to dry articles containing foam rubber or similarly textured rubber like - materials.



WARNING

To reduce the risk of fire or explosion:

- Do not dry items that have been previously cleaned, washed, soaked, or spotted with gasoline, dry cleaning solvents, or other flammable or explosive substances. They emit vapors that could ignite or explode. Any material that has been in contact with a cleaning solvent or flammable liquids or solids should not be placed in the dryer until all traces of these flammable liquids or solids and their fumes have been removed.
- There are many highly flammable items used in homes, such as acetone, denatured alcohol, gasoline, kerosene, some liquid household cleaners, some spot removers, turpentine, waxes, and wax removers.
- Do not dry items containing foam rubber (may be labeled latex foam) or similarly textured rubber-like materials on a heat setting. Heated foam rubber materials can, under certain circumstances, produce fire by spontaneous combustion.



CAUTION

- Do not sit on top of the dryer.
- Because of continuing product improvements, Insignia reserves the right of change specifications without notice. For complete details, see the Installation Instructions packed with your product before selecting cabinetry, making cutouts, or beginning installation.
- Do not dry clothing with large buckles, buttons, or other heavy metal or solid things.
- Install and use in accordance with the manufacturer’s instructions.
- Do not place items in your dryer that have been spotted or soaked with vegetable oil or cooking oil. Even after being washed, these items may contain significant amounts of these oils.
- Residual oil on clothing can ignite spontaneously. The potential for spontaneous combustion increases when items containing vegetable oil or cooking oil are exposed to heat. Heat source such as your dryer can warm these items, allowing an oxidation reaction in the oil to occur.

- Oxidation creates heat. If this heat cannot escape, the items can become hot enough to catch fire. Piling, stacking, or storing these kinds of items may prevent heat from escaping and can create a fire hazard.
- Take care that children's fingers are not caught in door when closing it. This may result in injury.
- Gas leaks may occur in your system, resulting in a dangerous situation.
- Gas leaks may not be detected by smell alone.
- Gas suppliers recommend you purchase and install a UL approved gas detector.

SAVE THESE INSTRUCTIONS

THIS APPLIANCE IS FOR HOUSEHOLD USE ONLY.

Features

Package contents

- 12-Cycle Electric or Gas Dryer
- *User Guide*

Front components

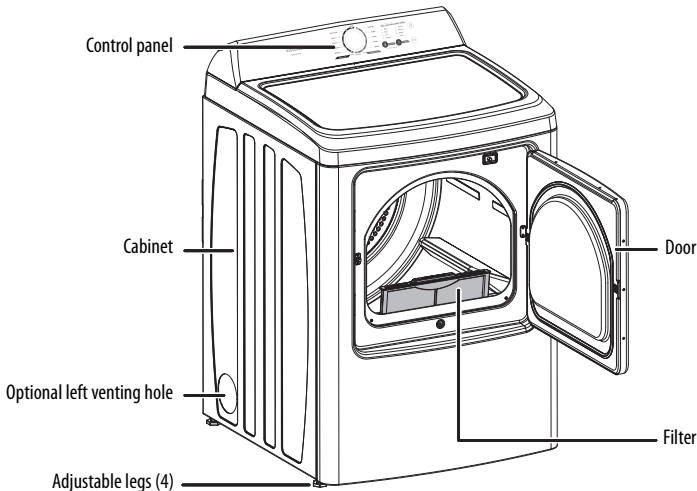

Back components

Electric Dryer

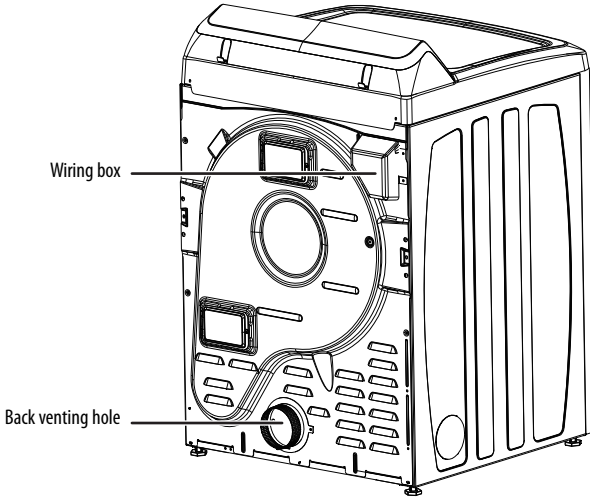

Gas Dryer

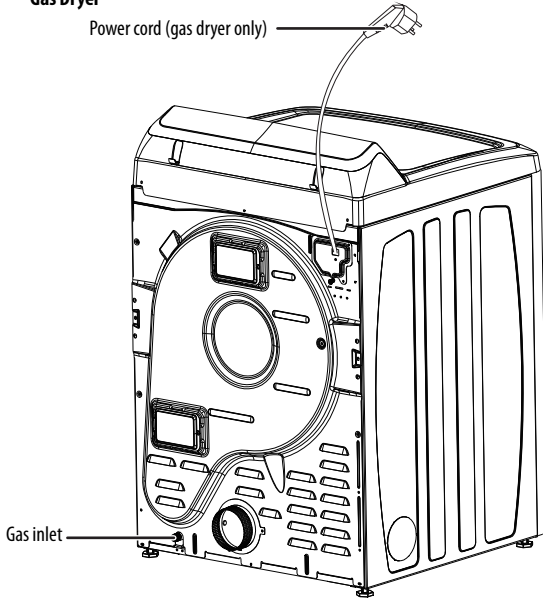

Control panel

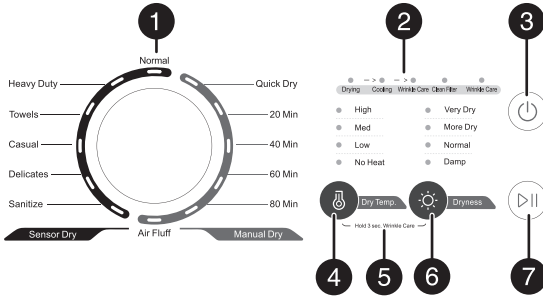

#	ITEM	DESCRIPTION
1	Cycle selector	Turn to select the cycle for the type of load. The cycle you select determines the heat control for the cycle. The Normal, Heavy Duty, Towels, Casual, Delicates, and Sanitize cycles are Sensor Dry cycles. The Quick Dry, Time Dry (20M, 40M, 60M, 80M), and Air fluff cycles are Manual Dry cycles. For more information, see Dryer options and settings on page 37.
2	Cycle status display	The Drying, Cooling, and Wrinkle Care (process) indicators flash to show which step of the dry cycle you are in. The Clean Filter indicator flashes 10 times when the dryer is turned on to remind you to clean the filter. The Wrinkle Care (option) indicator lights up when you turn on the setting.
3	Power	Press to turn your dryer on or off. If your dryer is on and idle for more than 10 minutes without any buttons being pressed, it automatically turns off.
4	Dry Temp.	Press repeatedly to select the drying temperature. <ul style="list-style-type: none"> • High: For sturdy cottons or those labeled Tumble Dry. • Med: For permanent press, synthetics, lightweight cottons, or items labeled Tumble Dry Medium. • Low: For lower heat than Medium to dry synthetic or washable knit fabrics. • No Heat: Provides just the air cycle without any heat.
5	Wrinkle Care	Press and hold Dry Temp. and Dryness for three seconds to add the Wrinkle Care step. Press again to cancel. Wrinkle Care provides approximately 90 minutes of intermittent tumbling in unheated air at the end of the cycle to reduce wrinkling. The load is already dry and can be removed at any time during the Wrinkle Care cycle.
6	Dryness	Press to select the dryness level. Different dryness levels result in different drying times. For clothes to be ironed manually, select a lower dryness level. For more information, see Dryer options and settings on page 37.
7	Start/Pause	Press to start or pause the drying cycle. When you pause the cycle, you can add items to the dryer, but you cannot change any settings.

Unpacking your dryer

WARNING:

- Packing materials can be dangerous to children. Keep all packing materials (such as plastic bags and polystyrene) out of the reach of children.
- Unpack your dryer and inspect it for shipping damage. Make sure that you have received all the items shown in [Package contents](#) on page Z.
- To prevent personal injury or strain, wear protective gloves and use a furniture mover whenever lifting or carrying your dryer.

Choosing a location



WARNING

Fire Hazard

- Clothes dryer installation must be performed by a qualified installer.
- Install the clothes dryer according to the manufacturer's instructions and local codes.
- Do not install a clothes dryer with flexible plastic venting materials. If flexible metal (foil type) duct is installed, it must be of a specific type identified by the appliance manufacturer as suitable for use with clothes dryer. Flexible venting materials are known to collapse, be easily crushed, and trap lint. These conditions will obstruct the clothes dryer's airflow and increase the risk of fire.
- To reduce the risk of severe injury or death, follow all installation instructions
- Save these instructions.



CAUTION

Important to installer

Read the following instructions carefully before installing the dryer. These instructions should be kept for future reference.

- The dryer is not suitable for installation in a mobile home.
- Remove the door from all discarded appliances to avoid the danger of a child being trapped and suffocating.
- The back of the dryer must be placed against a wall.

WARNING: Your dryer must be exhausted to the outside to reduce the risk of fire when installed any place inside the house.

- You should locate your dryer where there is enough space at the front for loading the dryer and enough space behind for the exhaust system.
- Your dryer is factory-ready for the rear exhaust option. If you want to change the vent location, see [Changing the dryer vent location \(optional\)](#) on page 22
- Make sure that the room you install your dryer in has enough fresh air and that there are no air-flow obstructions. The ambient temperature should not be lower than 33° F (.6° C).
- For gas dryers, adequate clearance must be maintained as noted on the data plate to ensure adequate air for combustion and the proper dryer operation.

- Do not install or store your dryer in an area where it will be exposed to water or weather. Keep the dryer area clear of combustible materials, gasoline, and other flammable vapors and liquids. Your dryer produces combustible lint. Keep the area around the dryer lint-free.

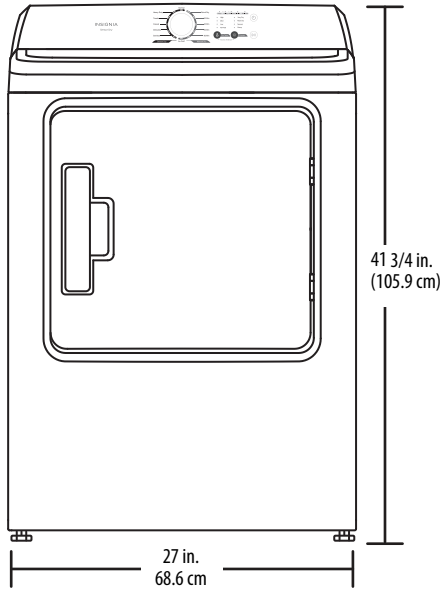

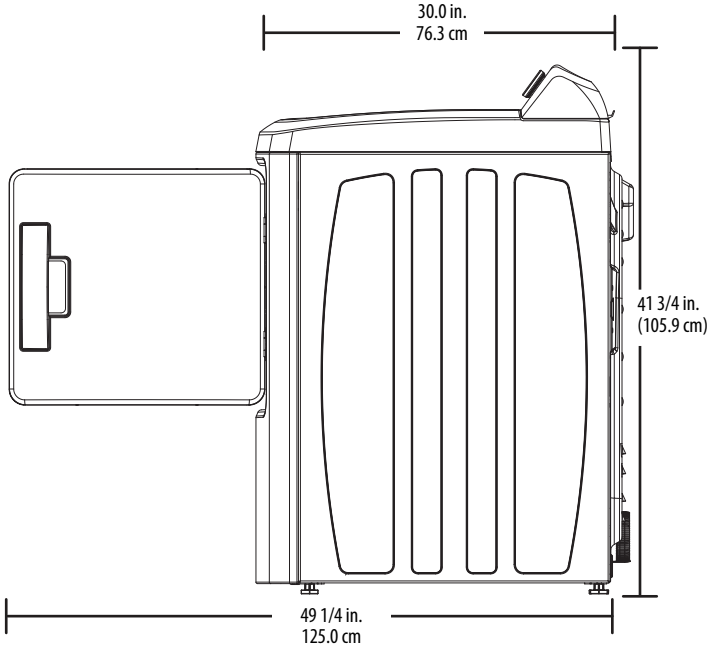

Installing side-by-side, or in an alcove, closet, or other recessed area

WARNING:

- You must exhaust your dryer to the outside to reduce the risk of fire when installed any place inside the house.
- Do NOT install another fuel-burning appliance in the same closet as your dryer.
- For information about how to select and install exhaust ducts, see [Exhausting requirements](#) on page 16.

Installing in a closed cabinet

Minimum clearances between your dryer and adjacent walls or other surfaces are:

- **Either side:** 1 in. (2.5 cm)
- **Rear:** 5 in. (12.7 cm)
- **Top:** 24 in. (61 cm)
- **Front:** 2 in. (5.1 cm)

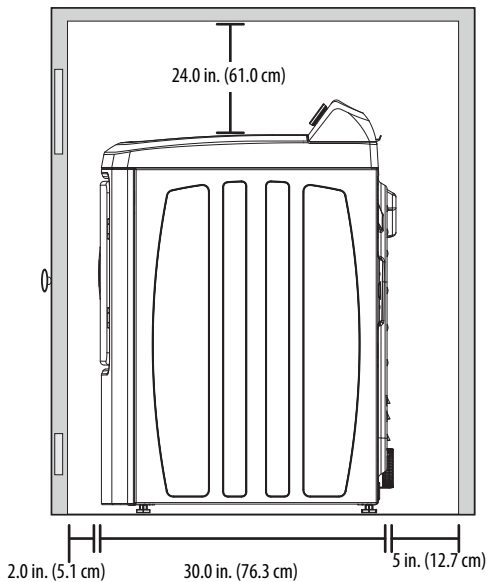
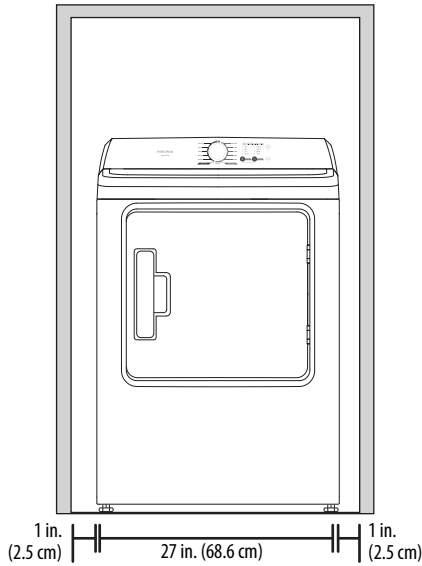

Note: The dryer can be installed in either the left or right side of the cabinet.

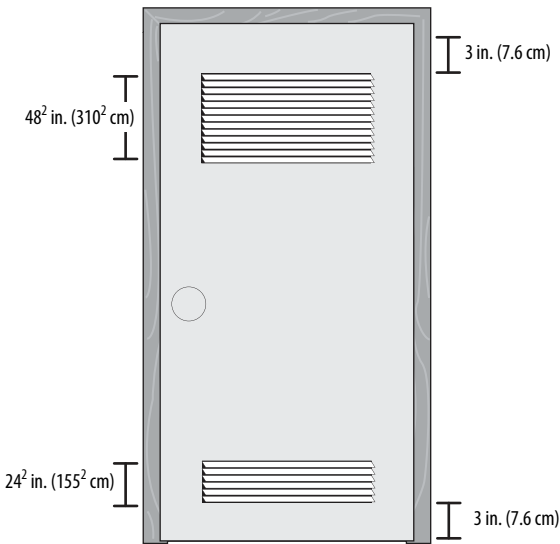
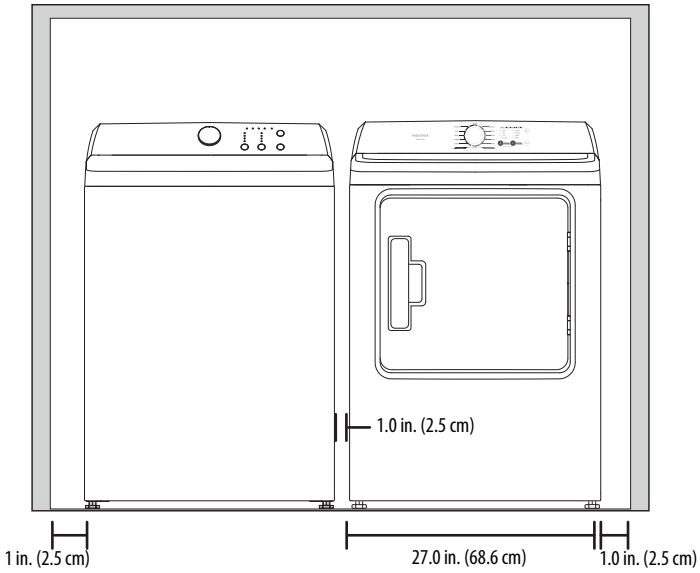

Exhausting requirements

WARNING:

- Do not exhaust your dryer into a chimney, a wall, a ceiling, an attic, a crawl space, or a concealed space in a building.
- Your dryer must be exhausted to the outside to reduce the risk of fire when installed in an alcove or closet.

WARNING:**NEVER USE A PLASTIC OR NON-METAL FLEXIBLE DUCT**

- If your existing duct work is plastic, non-metal, or combustible, replace it with metal.
- Use only a metal exhaust duct that is non-flammable to ensure containment of the exhaust air heat and lint.

- All dryers must be exhausted outside.
- Do not assemble the duct with screws or other fasteners that extend into the duct or that catch lint.
- The exhaust duct should be 4 in. (10.2 cm) in diameter.
- The total length of flexible metal duct should not exceed 7.8 ft. (2.4 m).

See [Duct requirements](#) on page 17 for the maximum duct length and number of elbows.

Duct requirements

WARNING:

You are responsible for correctly installing the exhaust system.

- Use a 4-inch (10.2 cm) diameter rigid aluminum or rigid galvanized steel duct. Do not use a smaller duct.
 - Ducts larger than 4 inches (10.2 cm) in diameter can result in increased accumulation of lint and changes in performance.
 - Lint should be removed regularly (from the internal filter every cycle and from ducts).
 - If you must use a flexible metal duct, use the type with a stiff sheet metal wall. Do not use a flexible duct with a thin foil wall. A serious blockage can result if the flexible metal duct is bent too sharply.
 - Never install any type of flexible duct in walls, ceilings, or other concealed spaces.
 - Keep the exhaust duct as straight and short as possible.
 - Secure joints with aluminum tape. Do not use screws.
 - Plastic, flexible ducts can kink, sag, be punctured, reduce airflow, extend drying times, and affect your dryer's operation.
 - Exhaust systems longer than the recommended 90 ft. (27.4 m) can extend drying times, affect dryer operations, and collect lint.
 - The exhaust duct should end with an exhaust hood that has a swing-out damper to prevent back drafts and entry of wildlife. Never use an exhaust hood with a magnetic damper.
 - The hood should have at least 12 inches (30.5 cm) of clearance between the bottom of the hood and the ground or other obstruction. The hood opening should point down.
 - Never install a screen over the exhaust outlet.
 - To avoid lint buildup, do not exhaust the dryer directly into a window well.
 - Do not exhaust under a house or porch.
 - If the exhaust duct must run through an unheated area, the duct should be insulated and slope slightly down towards the exhaust hood to reduce condensation and lint buildup.
 - Inspect and clean the interior of the exhaust system at least once a year.
 - Unplug the power cord before cleaning.
 - Check frequently to make sure that the exhaust hood damper opens and closes freely.
 - Check the condition of the exhaust vent system once per month, and clean at least once per year.
- Note:** If your clothes are not getting dry, check the ducting for obstructions.
- Do not exhaust the dryer into a wall, ceiling, crawl space, or concealed space of a building, gas vent, or any other common duct or chimney. This could create a fire hazard from the lint expelled by the dryer.
 - Do not use non-metallic flexible ducting.
 - To reduce the risk of fire, your dryer **MUST BE EXHAUSTED OUTDOORS.**

Exhaust hood types

If you install your dryer into an existing exhaust system you must make sure that:

- The exhaust system meets all local, state, and national codes.
- You do not use a flexible plastic duct.
- You inspect and clean all lint buildup from inside the existing duct.
- The duct is not dented or crushed.
- The exhaust hood damper opens and closes freely.

For best results, the static pressure in any exhaust system should be between 0.3 to 0.8 inches of water column, and it cannot be less than 0 under any circumstances with an installed duct with a four inch diameter. Measurement must be done with the empty dryer working with a manometer at the point where the exhaust duct connects to the dryer. A no-heat setting should be used. Lint filter must be clean.

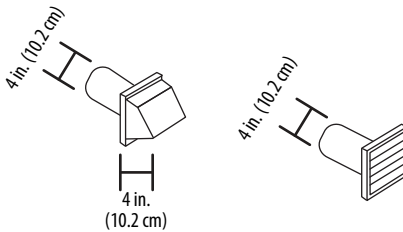
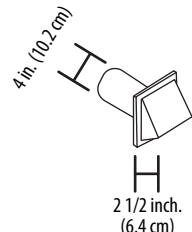
WEATHER HOOD TYPES		
	Recommended	Use only for short-run installation
		
# of 90° elbows	Rigid Metallic	Rigid Metallic
0	90 ft. (27.4 m)	60 ft. (18.3 m)
1	60 ft. (18.3 m)	45 ft. (13.7 m)
2	45 ft. (13.7 m)	35 ft. (10.7 m)
3	35 ft. (10.7 m)	25 ft. (7.6 m)

Electric requirements

WARNING:

The wiring diagram is located on the back panel of your dryer.

- Incorrectly connecting your dryer’s grounding conductor can result in electric shock. Check with a qualified electrician or serviceman if you are in doubt as to whether your dryer is correctly grounded. Do not modify the plug provided with your dryer. If the plug does not fit the outlet, have the correct type outlet installed by a qualified electrician.
- To prevent unnecessary risk of fire, electrical shock, or personal injury, all wiring and grounding must be done in accordance with local codes, or in the absence of local codes, with the National Electrical Code, ANSI/NFPA No. 70 - Latest Revision (for the U.S.) or the Canadian Electrical Code CSA C22.1-Latest Revisions and local codes and ordinances (for Canada). You are responsible for providing adequate electrical services for your dryer.
- All gas installations must be done in accordance with the latest revision of National Fuel Code ANSI Z223.1/NFPA 54 (for US) or CSA B149.1 (for Canada) and local codes and ordinances.

Electrical connections

An individual branch (or separate) circuit serving only your dryer is recommended. **DO NOT USE AN EXTENSION CORD.**

Gas models - U.S. and Canada

A 120-volt, 60Hz AC approved electrical service, with a 15 ampere fuse or circuit breaker is required.

Electric models - U.S. only

The dryers require a 120/240 volt, 60Hz AC approved electrical service. The electric service requirements can be found on the data label located behind the door. A 30-ampere fuse or circuit breaker on both sides of the line is required.

- If you use a power cord, you should plug the cord into a 30-ampere receptacle.
- A power cord is NOT provided with U.S. electric model dryers.

WARNING: RISK OF ELECTRIC SHOCK

When local codes allow, the electrical supply of your dryer may be connected by means of a new power supply cord kit, marked for use with a dryer, that is UL listed and rated at a minimum of 120/240 volts, 30-ampere with three No. 10 copper wire conductors terminated with closed loop terminals, open-end spade lugs with turned up ends, or with tinned leads.

- Do not reuse a power supply cord from an old dryer. The power cord electric supply wiring must be retained at the dryer cabinet with a suitable UL-listed strain relief.
- Grounding through the neutral conductor is prohibited for (1) new branch-circuit installations, (2) mobile homes, (3) recreational vehicles, and (4) areas where local codes prohibit grounding through the neutral conductor. (Use a four-prong plug for four-wire receptacles, NEMA type 14-30R.)

Electric models - Canada only

You need a 120/240 volt, 60Hz AC approved electrical service fused through a 30-ampere fuse or circuit breaker on both sides of the line.

All Canadian models are shipped with the power cord attached. The power cord should be plugged into a 30-ampere receptacle.

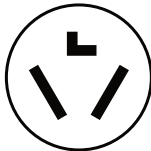
Power outlet types

Three-wire outlet (10-30R)

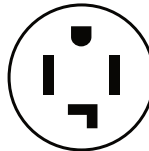

Four-wire outlet (14-30R)

Using a three-wire outlet

If your outlet is a three-wire (three-prong) outlet, choose a three-wire power supply cord with ring or spade terminals and UL listed strain relief. The three-wire power supply cord must:

- Be at least 4 ft. (1.2 m) long.
- Have three 10-gauge solid copper wires.
- Match a three-wire outlet of NEMA Type 10-30R.

See [Three-wire outlet - for electric dryers](#): on page [29](#) for instructions on how to connect a power cord to your dryer.

Using a four-wire outlet

If your outlet is a four-wire (four-prong) outlet, choose a four-wire power supply cord with ring or spade terminals and UL listed strain relief. The four-wire power supply cord must:

- Be at least 4 ft. (1.2 m) long.
- Have four 10-gauge solid copper wires.
- Match a four-wire outlet of NEMA Type 14-30R. The ground wire (ground conductor) may be either green or bare. The neutral conductor must be identified by a white color.

See [Four-wire outlet - for electric dryers](#): on page [30](#) for instructions on how to connect a power cord to your dryer.

Gas requirements

Use only natural or LP (liquid propane) gases.

THE INSTALLATION MUST CONFORM WITH LOCAL CODES, OR IN THE ABSENCE OF LOCAL CODES, WITH THE NATIONAL FUEL GAS CODE, ANSI Z223.1/NFPA 54, LATEST REVISION (FOR THE UNITED STATES), OR THE NATURAL GAS AND PROPANE INSTALLATION CODE, CSA B149.1, LATEST REVISION (FOR CANADA).

Gas dryers are equipped with a burner vent for use with natural gas. If you plan to use your dryer with LP (liquid propane) gas, it must be converted for safe and proper performance by a qualified service technician.

A ½ in. (1.27 cm) gas supply line is recommended and must be reduced to connect to the 3/8 in. (1 cm) gas line on your dryer. The National Fuel Gas Code requires that an accessible, approved manual gas shut-off valve be installed within 6 in. (15 cm) of your dryer.

Gas dryers installed in residential garages must be raised 18 in. (46 cm) above the floor.

Additionally, a 1/8 in. (0.3 cm) N.P.T. (National Pipe Thread) plugged tapping, accessible for test gauge connection, must be installed immediately upstream of your dryer's gas supply connection.

Your dryer must be disconnected from the gas supply pipe system during any pressure testing of the system.

Your dryer must be connected to the gas supply piping with a listed flexible gas connector that complies with the standard for connectors for gas appliances, ANSI Z21.24 or CSA 6.10.

DO NOT reuse old flexible metal gas lines. Flexible gas lines must be design certified by the American Gas Association (CGA in Canada).

- Any pipe joint compound used must be resistant to the action of any liquefied petroleum gas.
- As a courtesy, most local gas utilities will inspect a gas appliance installation.

Gas ignition: Your dryer uses an automatic ignition system to ignite the burner. There is no constant burning pilot.

COMMONWEALTH OF MASSACHUSETTS INSTALLATION INSTRUCTIONS

Your dryer must be installed by a licensed plumber or gas fitter. A "T" handle manual gas valve must be installed in the gas supply line to the installed dryer at the location of operation.

If a flexible gas connector is used to connect the dryer, the connector may not be longer than 3 ft. (91.5 cm).

WARNING:

Gas leaks may occur in your system, creating a dangerous situation.

- Gas leaks may not be detected by smell alone.
- Gas suppliers recommend that you purchase and install a UL-approved gas detector.
- Install and use it in accordance with the manufacturer's instructions.

Grounding requirements

Your dryer must be grounded. If a malfunction or breakdown occurs, the grounding reduces the risk of electrical shock by providing a path of least resistance for the electrical current.

Gas models

WARNING:

- Your dryer has a three-prong power cord with grounding conductor (120V, 60Hz).
- The plug must be plugged into an appropriate outlet that is properly installed and grounded in accordance with all local codes and ordinances.
- Certain internal parts are intentionally not grounded and may present a risk of electric shock only during servicing. Service Personnel – Do not contact the following parts while the appliance is energized: inlet valve, control board, and temperature-regulating thermistor (located on blower housing).

Electric models

WARNING:

- Dryer must be grounded with three- or four-wire cord power cord with a grounding conductor and a grounding plug, which is sold separately.
- The plug must be plugged into an appropriate outlet that is properly installed and grounded in accordance with all local codes and ordinances.
- Do not modify the plug provided with your dryer - if it doesn't fit the outlet, have a proper outlet installed by a qualified electrician.
- If a power cord is not used and the electric dryer is to be permanently wired, the dryer must be connected to a permanently grounded metal wiring system, or an equipment grounding conductor must be run with the circuit conductors and connected to the equipment grounding terminal or lead on the dryer.
- Certain internal parts are intentionally not grounded and may present a risk of electric shock only during servicing. Service Personnel – Do not contact the following parts while the appliance is energized: inlet valve, control board and temperature-regulating thermistor (located on blower housing).

Changing the dryer vent location (optional)

This dryer is shipped to vent from the back. It can also be configured to vent to the bottom or left side.

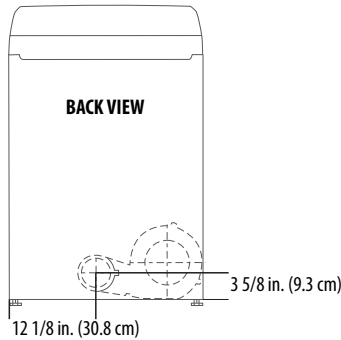

Tools you will need

Adapter kits are standard components and can be purchased from any retailer.

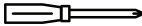

Phillips screwdriver



Aluminum tape



Gloves

Materials you will need

- 4 in. (10.2 cm) duct (rigid or UL-listed flexible metal) (not included)
- 4 in. (10.2 cm) elbow (not included)
- Adapter duct (not included)

Side venting

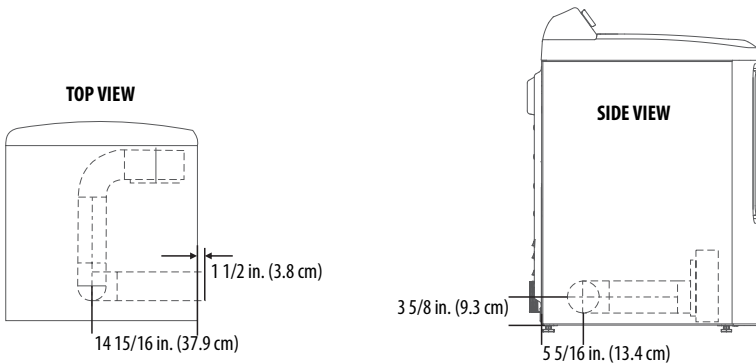

- 1 Remove the two rear exhaust retaining screws, then pull out the exhaust duct.

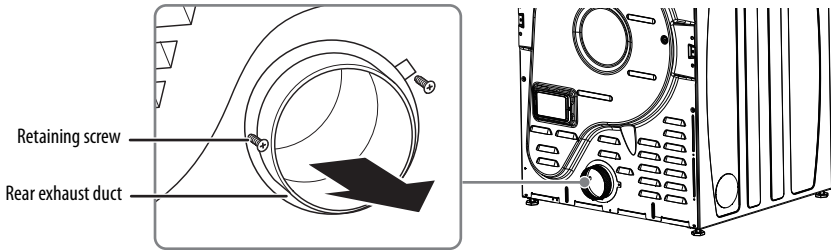

- 2 Press the tabs on the knockout, then carefully remove the knockout for the desired vent opening.
- 3 Push the adapter duct onto the blower housing of the dryer.

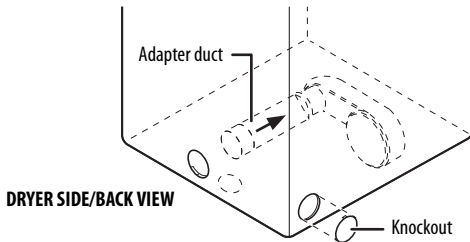

- 4 Connect a 4 in. (10.2 cm) elbow to the 4 in. (10.2 cm) duct section, and secure all joints with aluminum tape. Make sure that the male end of the elbow faces away from the dryer.
- 5 Insert the elbow/duct assembly through the side opening and press it onto the adapter duct. Secure in place with aluminum tape. The male end of the duct should protrude 1 1/2 in. (3.8 cm) out of the dryer to connect the remaining ductwork.
- 6 Attach aluminum tape to the back of the dryer to seal the original dryer vent hole.

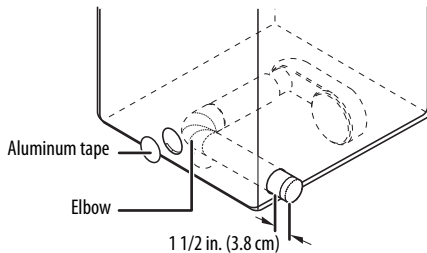

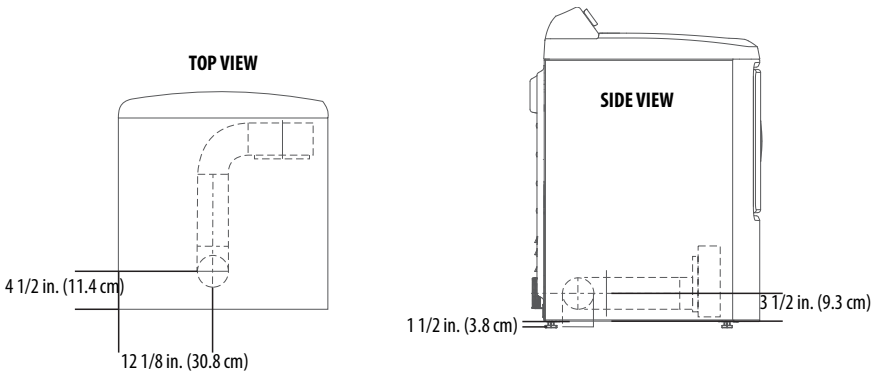
Bottom venting

- 1 Remove the two rear exhaust retaining screws, then pull out the exhaust duct.

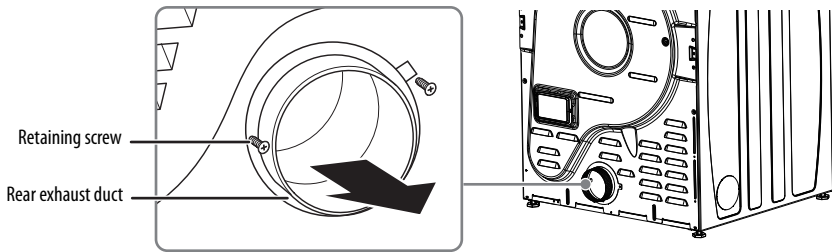

- 2 Press the tabs on the knockout, then carefully remove the knockout for the desired vent opening.
- 3 Push the adapter duct onto the blower housing of the dryer.

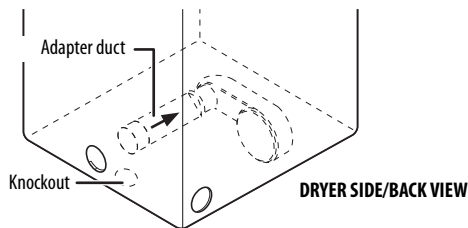

- 4 Connect a 4 in. (10.2 cm) elbow to the 4 in. (10.2cm) duct section, and secure all joints with aluminum tape. Make sure that the male end of the elbow faces down through the hole in the bottom from the dryer.
- 5 Insert the elbow/duct assembly through the rear opening and press it onto the adapter duct. Secure in place with aluminum tape. The male end of the duct should protrude 1 1/2 in. (3.8 cm) out of the dryer to connect the remaining ductwork.

- 6 Attach aluminum tape to the back of the dryer to seal the original dryer vent hole.

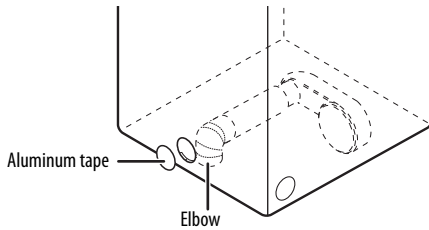

Installing your dryer

Important: We recommend that you use a qualified installer to install your dryer.

Tools you will need

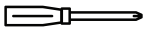

Phillips screwdriver



Level

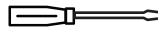

Flat-head screwdriver



Aluminum tape



Pliers



Pipe wrench



Adjustable wrench that opens to 1" (2.5 cm)



Cutting knife

Materials you will need

- 3/8" gas dryer gas line (Gas model only)
- Three- or four-prong (dependent on owner's house) electric power cord (electric model only)
- Exhaust dryer vent kit

Before you start

Before you start installing your dryer, make sure that:

- The location you selected has a grounded electrical outlet. See [Grounding requirements](#) on page 21.
- For U.S. models, you have the correct type power cord (not included). See [Electric requirements](#) on page 18.
Note: For Canadian models, the power cord comes pre-installed.
- Your dryer vent is in the correct location. See "[Changing the dryer vent location \(optional\)](#)" on page 22 to change where your dryer vents.
- Your exhaust ducting (not included) is made of rigid metal or semi-rigid metal. See [Duct requirements](#) on page 17.
- You have a 3/8 in. (1 cm) gas dryer gas line (if you are installing a gas dryer) that meets all national and local codes. Before you connect the gas line, review the gas line requirements in [Gas requirements](#) on page 20.

Step-by-step instructions

Note: If a gas dryer is being installed, you will need to call a licensed professional to do the installation.

Step 1: Make sure that the floor is a solid, level surface

- Use a level to make sure that the floor where you are installing your dryer is level. This helps minimize vibration, noise, and unwanted movement.

Notes:

- If the front of the dryer is higher than the rear by more than one degree, it may take longer to dry small loads. You can adjust the dryer feet to level your dryer ([Step 3: Connect the exhaust ducting](#) on page 26).
- If the floor is not perfectly level, the legs can be adjusted to make the dryer level and stable. The dryer must be leveled after it is set in place.

Step 2: Move your dryer to the location you selected

- Move your dryer to the location you selected, but do not push your dryer all the way back into the location. You need to connect the power cord and ducting before you move your dryer into its final position.

Tip: For information about space requirements for a side-by-side installation, see [Installing side-by-side, or in an alcove, closet, or other recessed area](#) on page 13.

Step 3: Connect the exhaust ducting

Important: Before you connect the exhaust ducting, review ducting requirements in [Duct requirements](#) on page 17.

WARNING:

- Make sure that your dryer is installed properly so it exhausts air easily.
 - Keep ducts as straight as possible.
 - DO NOT restrict your dryer with a poor exhaust system.
 - DO NOT use unnecessarily long ducts that have many elbows.
 - Use a 4 in. (10.2 cm) diameter rigid metal duct. Tape all joints, including at the dryer. Never use lint-trapping screws.
 - Clean all old ducts before installing your new dryer. Be sure the vent flap opens and closes freely. Inspect and clean the exhaust system annually.
 - DO NOT use a plastic, thin foil, or non-metal flexible duct.
 - DO NOT use sheet metal screws that can accumulate lint when assembling the ducting. Joints should be taped.
 - DO NOT let the aluminum tape cover the ventilation slots on the back of your dryer.
 - DO NOT use dented or clogged ducts and vent.
- 1 Make sure that the exhaust hood flapper or louvers move freely.
If you do not have an exhaust hood installed, see [Exhaust hood types](#) on page 17 for information about recommended hood types. **We recommend that you have a professional install the exhaust hood.**

- 2 Connect one end of the exhaust ducting to the venting hole on the back of your dryer, then use aluminum tape to secure the ducting to your dryer. The crimped ends of the duct sections must point away from your dryer. Use a 4 in. (10.2 cm) diameter rigid metal duct.

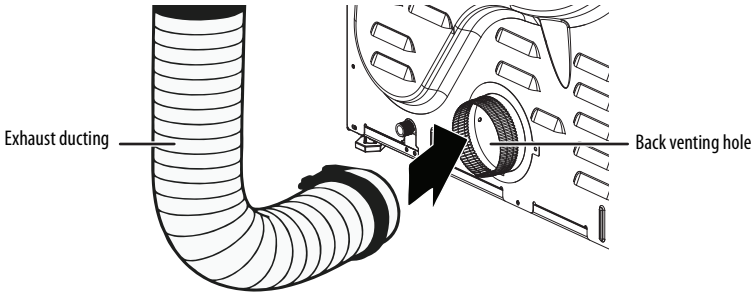

- 3 Connect the other end of the ducting to the exhaust hood, then tighten the duct strap to secure it in place. Tape all joints, including at the dryer.

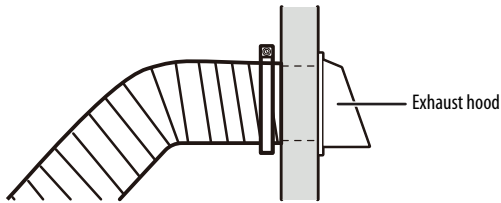

Step 4: Connect the gas line (for gas models only)

Important: Before you connect the gas line, review the gas line requirements in [Gas requirements](#) on page 20.

- 1 Remove the pipe thread protective cap from the gas inlet.

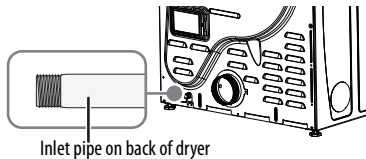

- 2 Connect all the pipe joints and tighten with a wrench.

Note: An additional fitting is required to connect the 3/4 in. (1.9 cm) female thread end of a flexible connector to the 3/8 in. (1 cm) male threaded end on the dryer. Use only new AGA or CSA certified gas supply line with SS flexible connectors. The National Fuel Gas Code requires that an accessible, approved manual gas shutoff valve be installed within 6 in. (15 cm) of your dryer.

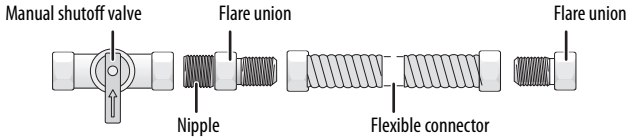

- 3 Apply a pipe joint compound or about 1.5 in. wraps of teflon tape over all threaded connections. The pipe joint compound must be resistant to the actions of any liquefied petroleum gas.
- 4 Connect the gas supply to your dryer.

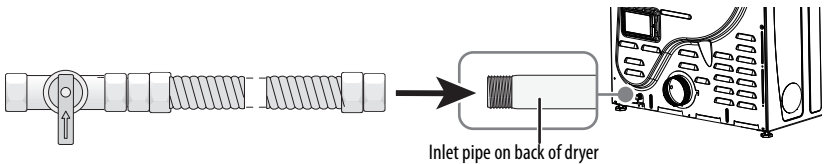

- 5 Securely tighten the gas line fitting over the threads.
- 6 Turn on the gas supply.

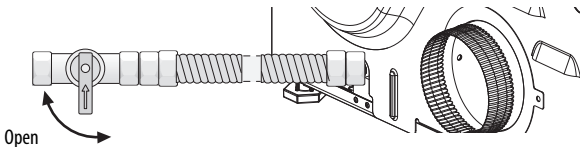

WARNING:

- All gas installations of the dryer must be equipped with Manual Shut-Off valve.
- Uncoated copper tubing will corrode when subjected to natural gas, causing gas leaks. Use ONLY black iron, stainless steel, or plastic-coated brass piping for gas supply.
- Check all gas connections for leaks using a soap solution.
- If bubbles appear, tighten the connections and recheck. DO NOT use an open flame to check for gas leaks.

Step 5: Connect the power cord (U.S. models only)**Important:**

- Before you connect the power cord, review the electric requirements in [Electric requirements](#) on page 18.
 - Before testing or operating your dryer, make sure that your dryer is grounded. See [Grounding requirements](#) on page 21.
- Determine whether your electric outlet is a three-wire or four-wire outlet. See [Power outlet types](#) on page 19.

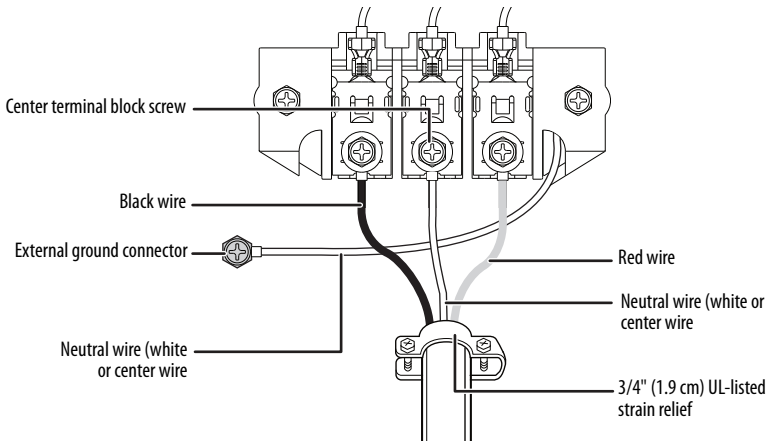
Three-wire outlet - for electric dryers:

- 1 On your dryer, remove the center terminal block screw.
- 2 Connect the neutral wire (white or center wire) of the power cord to the center terminal screw of the terminal block. Be sure to cross the screw through the ring of the power cord terminal and tighten the screw.
- 3 Connect the other wires to the outer terminal block screws. Be sure to cross the screw through the terminal ring and tighten the screw.
- 4 Tighten the strain relief screws.
- 5 Insert the tab of the terminal block cover into your dryer's rear panel slot, then secure the cover with a screw.

WARNING: If you are converting from a four-wire electrical system to a three-wire, you must reconnect the ground strap to the terminal block support to ground the dryer frame to the neutral conductor. Ring-type terminals are recommended. If using strap terminals, make sure that they are tightened.

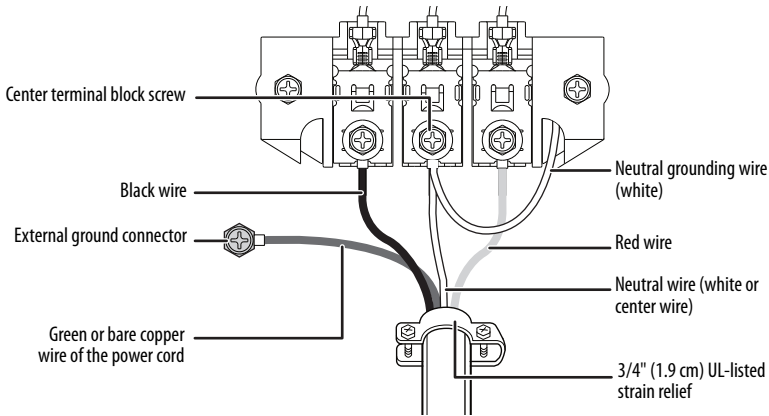
Four-wire outlet - for electric dryers:

- 1 Remove the center terminal block screw.
- 2 Connect the ground wire (green or unwrapped) of the power cord to the external ground conductor screw.
- 3 Connect the neutral wire (white wire) of the power cord and the appliance ground wire (white) under the center screw of the terminal block. Be sure to cross the screw through the ring of the power cord terminal and tighten the screw.
- 4 Connect the other wires to the outer terminal block screws. Be sure to cross the screw through the terminal ring and tighten the screw.
- 5 Tighten the strain relief screws.
- 6 Insert the tab of the terminal block cover into your dryer's rear panel slot, then secure the cover with a screw.

WARNING: Electrical Shock Hazard

- All U.S. models are produced for a THREE-WIRE SYSTEM CONNECTION.
- The dryer frame is grounded to the neutral conductor at the terminal block. A FOUR-WIRE SYSTEM CONNECTION is required for new or remodeled construction, mobile homes, or if local codes do not permit grounding through neutral conductor. If the four-wire system is used, the dryer frame cannot be grounded to the neutral conductor at the terminal block. See "Electric requirements" on page 18 for three-wire or four-wire system connections.

Step 6: Level your dryer

- If your dryer is not level, carefully tilt your dryer just enough to adjust the leveling feet on the bottom of your dryer. Extend the feet only as much as is necessary. If the feet are extended too much, your dryer may vibrate.

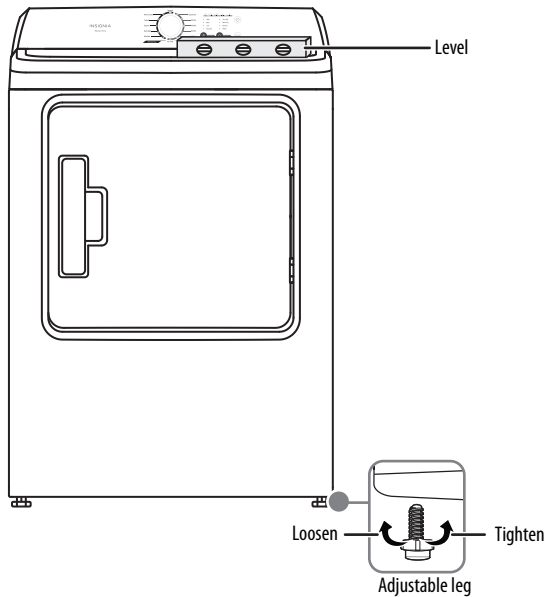
**Step 7: Plug in your dryer**

Make sure that all exhaust and electrical connections are complete, then plug your dryer into the electrical outlet.

Step 8: Check the final installation

- Before you use your dryer, make sure that:
 - The dryer is plugged into an electrical outlet and is properly grounded.
 - Rigid or semi-rigid metal vent material is installed. Do not use a plastic flexible ducting.
 - The exhaust duct work is hooked up and the joints are taped.
 - The dryer is level and sits firmly on the floor.
 - Gas models: the gas is turned on with no gas leakage.
- Start your dryer to confirm that it runs, heats, and shuts off.

Note for GAS MODELS ONLY: The burner may not ignite initially due to air in the gas line. Allowing your dryer to operate on a heat setting will purge the line. If the gas does not ignite within five minutes, turn your dryer off and wait five minutes. Be sure the gas supply to your dryer has been turned on. To confirm gas ignition, check the exhaust for heat.

Reversing the dryer door

- 1 Make sure that the power cord is unplugged.
- 2 While supporting the door, remove the four hinge screws from the door, then lift the door to remove it and set the door aside.

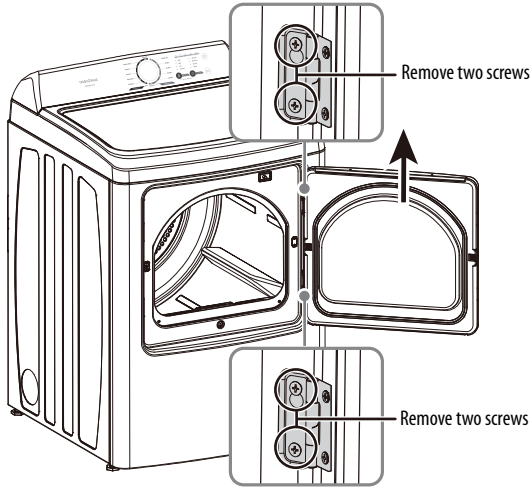

CAUTION: Be careful not to drop the door when removing the screws.

- 3 Remove the screws for the locker cover on the right side of the dryer and the screws for the locker cover on the left side of the dryer.
- 4 Install the locker onto the right side of the dryer with the screws you just removed, then install the locker cover on the left side of the dryer.

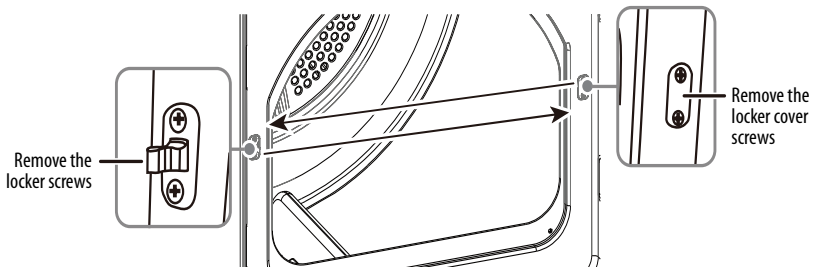

- 5 Remove the 12 screws around the door.

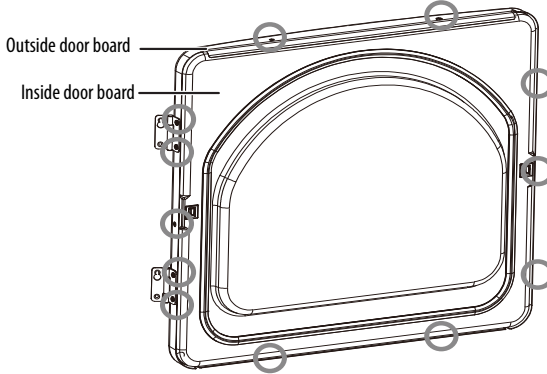

- 6 Pull the inside door board from the outside door board.
- 7 Rotate the outside door board 180°, then reassemble it with the inside door board with the screws you removed previously.

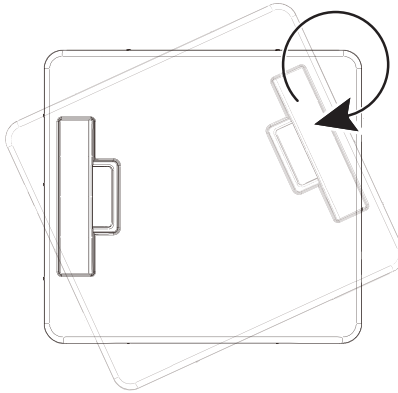

- 8 Install the hinges onto the left side of the dryer.

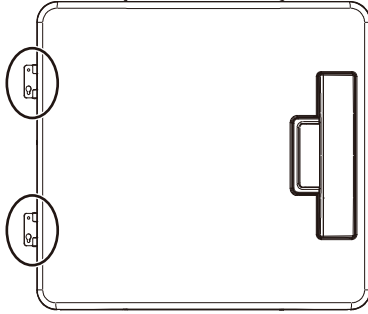

- 9 Align the hinges on the door with the hinge screw holes on the front of your dryer, then secure the door with the four screws you previously removed.

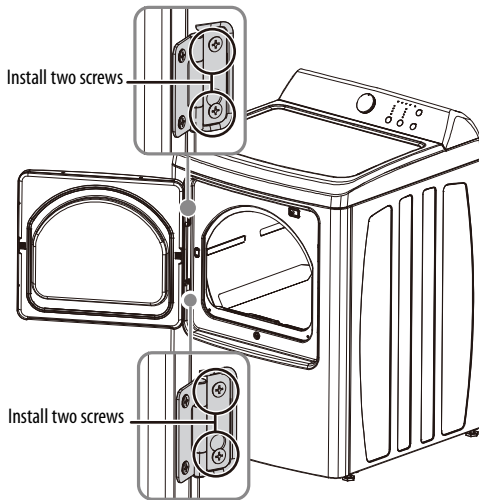

Using your dryer

WARNING: To reduce the risk of fire, electric shock, or injury to persons, read the IMPORTANT SAFETY INSTRUCTIONS before operating this appliance.

Drying a load of clothes

Step 1: Turn on your dryer

- Press the  (power) to turn on your dryer. The Clean Filter indicator flashes 10 times when your dryer is powered on. Clean the filter before loading the dryer.



Step 2: Load your dryer

- Place only one wash load in your dryer at a time.
- Heavy and light weight fabrics take different amounts of time to dry. If you mix heavy and light weight fabrics in a load, lightweight fabrics may be dry at the end of the cycle while heavy fabrics may still be damp.
- If you only need to dry one or two items, you can improve the tumbling action and drying efficiency by adding a couple of similar items to the load.
- Overloading restricts tumbling action which results in uneven drying and excessive wrinkling of some fabrics.

Step 3: Select the dryer cycle and options

- 1 Turn the Cycle Selector to select a drying cycle. For more information, see [Dryer options and settings](#) on page 37.

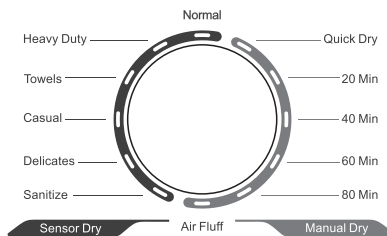

- 2 **Optional:** Use the control panel buttons (like **Dry Temp.**) to customize the drying cycle. For descriptions of buttons, see [Control panel](#) on page 9. For information about which buttons are available for each cycle type, see [Dryer options and settings](#) on page 37.

Step 4: Start your dryer

- 1 Press the ►|| (start/pause) button. The Drying indicator illuminates.



- 2 If you need to pause the cycle (for example to add or remove items or adjust the load), press the ►|| (start/pause) button, then open the door. Your dryer stops tumbling. When you are ready to start drying again, close the door, then press the ►|| (start/pause) button.

Unloading your dryer

- 1 When the drying cycle is over, your dryer beeps six times and then turns off.
- 2 Open the door and remove the items.

Note: You should clean the lint filter after every load to avoid lint buildup and to make sure that your dryer is running efficiently. See [Cleaning the lint filter](#) on page 36.

Cleaning the lint filter**CAUTION:**



- Do not operate your dryer without the lint filter in place.
- Do not use a damaged or broken lint filter. This may reduce performance or cause a fire.



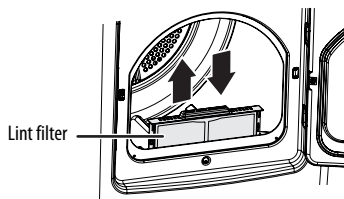





Note:



- You should clean the lint filter before every load to shorten the drying time and to make sure that your dryer is running efficiently.
 - If the lint is difficult to wipe away, you can gently wash the filter in mild, soapy water. Make sure that you rinse all the soap off the filter and that the filter is dry before you put it back into your dryer.
- Gently pull the lint filter out of the slot at the bottom of the drum. Remove the accumulated lint, then insert the filter back into the slot.



Dryer options and settings

- Settings in **bold** are initial settings. The • (dot) indicates optional functions you can select.
- For best results, follow the wet load size recommendations noted for each cycle:
 -  **Small load:** Fill the dryer drum with three to four items, not more than 1/4 full.
 -  **Medium load:** Fill the dryer drum up to about 1/2 full.
 -  **Large load:** Fill the dryer drum up to about 3/4 full. Do not overload. Items need to tumble freely.

CYCLE	FABRIC TYPE	TEMP	DRYNESS	MAX AMOUNT
Normal	<ul style="list-style-type: none"> • Cotton • Underwear • Linen 	High	Very Dry More Dry Normal Damp	
Heavy Duty	<ul style="list-style-type: none"> • Jeans • Corduroys • Work clothes 	High	Very Dry More Dry Normal Damp	
Towels	<ul style="list-style-type: none"> • Towels • Heavy cottons 	High	Very Dry More Dry Normal Damp	
Casual	<ul style="list-style-type: none"> • Wrinkle-free cottons • Synthetic fabrics • Knits 	Medium	Very Dry More Dry Normal Damp	
Delicates	<ul style="list-style-type: none"> • Sensitive items 	Low	Very Dry More Dry Normal Damp	
Sanitize	<ul style="list-style-type: none"> • Bedding • Curtains 	High	Very Dry	
Quick Dry		High Med Low No Heat	n/a	
20 Min		High Med Low No Heat	n/a	
40 Min		High Med Low No Heat	n/a	

CYCLE	FABRIC TYPE	TEMP	DRYNESS	MAX AMOUNT
60 Min		High Med Low No Heat	n/a	
80 Min		High Med Low No Heat	n/a	
Air Fluff		No Heat	n/a	

Special laundry tips

ITEMS	DRYING GUIDE
Bedspreads and comforters	<ul style="list-style-type: none"> Follow the care label instructions or dry using the 60 Min or 80 Min cycle (Medium Temp). Make sure that the item is thoroughly dry before using or storing. During the drying cycle, you may need to reposition the item to make sure that it is completely dried.
Blankets	<ul style="list-style-type: none"> Use the Normal cycle and dry only one blanket at a time for best tumbling action. Make sure that the item is thoroughly dry before using or storing. During the drying cycle, you may need to reposition the item to make sure that it is completely dried.
Curtains and draperies	<ul style="list-style-type: none"> Use the cycle recommended on the care instructions or the Casual cycle. Medium temperature and Normal dry to help minimize wrinkling Dry these in small loads for best results and remove as soon as possible.
Cloth diapers	<ul style="list-style-type: none"> Use the Normal cycle on the High temperature setting for soft fluffy diapers.
Down filled items (like jackets, sleeping bags, or comforters)	<ul style="list-style-type: none"> Use the Delicates cycle or a Timed dry cycle with low temperature. Add a couple of dry towels to absorb moisture and shorten drying time.
Foam rubber (like rug backs, stuffed toys, or shoulder pads,)	<ul style="list-style-type: none"> DO NOT dry on a temperature setting. Use the Air Fluff cycle (no heat). WARNING: Drying a rubber item with heat may damage it or create a fire hazard.
Pillows	<ul style="list-style-type: none"> Use the Normal cycle. Add a couple of dry towels and a pair of clean sneakers or tennis balls to help the tumbling action and to fluff the item. DO NOT dry kapok or foam pillows in the dryer.
Plastics (like shower curtains or outdoor furniture covers)	<ul style="list-style-type: none"> Use the Air Fluff or a Manual Dry cycle on the Low temperature setting depending on the care label instructions.

CAUTION:

Items NOT to dry:





- Fiberglass items (curtains, draperies, etc.)
- Woolens, unless recommended on the label.
- Items spotted or soaked with vegetable or cooking oils.

Fabric Care Chart



Follow the cleaning and care labels on clothes and other fabrics.

	Gentle/Delicates
---	------------------



Wash Cycle

	Normal
	Permanent Press / Wrinkle Resistant / Wrinkle Control
	Gentle/Delicates
	Hand wash





Special Instructions

	Line dry/ Hang to dry
	Drip dry
	Dry flat



Water Temperature

	Hot
	Warm
	Cold





Heat Setting

	High
	Medium
	Low
	Any heat
	No heat/air

Bleach

	Any bleach (when needed)
	Only non-chlorine (color-safe) bleach (when needed)
	Tumble dry cycle







Iron-dry or steam temperatures

	High
	Medium
	Low
	For machine washable wool. Loads should be under 8 lbs. (3.6 kg)





Normal

	Permanent Press / Wrinkle Resistant / Wrinkle Control
---	---

Warning symbols for laundering

	Do not wash
	Do not wring
	Do not bleach
	Do not tumble dry
	No steam (added to iron)
	Do not iron

Dry clean

	Dry clean
	Do not dry clean
	Line dry/Hang to dry
	Drip dry
	Dry flat

Maintaining your dryer

Cleaning the exterior

- Clean with a soft, damp cloth. Do not use abrasive substances.
- Protect the surface from sharp objects.
- Do not place any heavy or sharp objects or a detergent box on the dryer. Keep them in a separate storage area. These items may scratch or damage the top cover of the dryer.
- Because the entire dryer has a high-gloss finish, the surface can be scratched or damaged. Avoid scratching or damaging the surface when using the dryer.

Cleaning the drum

- Clean with a damp cloth dampened with a mild, non-abrasive cleaner suitable for stainless steel and anodized surfaces.
- Remove the cleaner residue and dry with a clean cloth.

Cleaning the control panel

- Clean with a soft, damp cloth. Do not use abrasive substances.
- Do not spray cleaners directly on the panel. The control panel finish may be damaged by some laundry pre-treatment soil and stain remover products. Apply such products away from your dryer and wipe up any spills or over-spray immediately.

Cleaning and inspecting the exhaust system

Inspect and clean the exhaust yearly to maintain optimum performance.

- 1 Disconnect the exhaust duct from the dryer and from the exhaust hood (at the exhaust outlet) outside of the building.
- 2 Check the interior of the duct and remove any lint accumulation.
- 3 Make sure that lint is removed from the exhaust hood. Lint may collect in the exhaust hood so that the flappers or louvers will not open or close completely.

- 4 After cleaning the exhaust hood, make sure that the flapper or louvers move freely.
- 5 Reassemble the exhaust duct and hood, making sure that the joints are secure and sealed.
- 6 Operate your dryer and make sure that the exhaust air is not obstructed in the vent and that there are no leaks in the system.

Note: Check and clean the outside exhaust hood frequently to ensure a proper air flow.



Certain internal parts are intentionally not grounded and may present a risk of electric shock only during servicing. Service Personal: Do not contact the following parts while the appliance is energized: Control Board and Temperature-Regulating Thermistor (located on the Blower Housing).

Troubleshooting

CAUTION: Do not try to repair your dryer yourself. Doing so invalidates the warranty.

PROBLEM	SOLUTION
Dryer does not start.	<ul style="list-style-type: none"> • Make sure that the dryer door is closed completely. • If you opened the door during the drying cycle, press the ► (start/pause) button again. • Make sure that the power cord is plugged into a working electrical outlet. • Check the circuit breaker and fuses for your dryer's electrical connection.
Dryer does not heat or does not dry.	<ul style="list-style-type: none"> • Your dryer may have moved into the cool-down process of the cycle. This is normal. • Select a cycle other than Air Fluff and a temperature setting that is not "No Heat." • Do not overload your dryer. Depending on the size of your washer, one wash load should equal one dry load. • Dry heavy items and lightweight items separately. • If you are drying large, bulky items, like blankets or comforters, try repositioning the load to ensure even drying. This may need to be done a few times throughout the cycle. • The load may be too small to tumble correctly. Add a few towels or use the Manual Dry cycles. • Clean the lint filter and exhaust duct. • Check the circuit breaker and fuses for your dryer's electrical connection. • Make sure that the outside exhaust hood opens and closes freely. • Check the exhaust system for lint buildup. Ducting should be inspected and cleaned annually. • Make sure that your exhaust duct is a 4 in. (10.2 cm) rigid or semi-rigid metal duct.

PROBLEM	SOLUTION
Dryer is noisy.	<ul style="list-style-type: none"> • It is normal for your dryer to hum due to the high velocity of air moving through the dryer drum and exhaust system. • It is normal to hear the dryer gas valve or heating element cycle on and off during the drying cycle. • Check the load for objects, like coins, loose buttons, nails, or broken zippers. Remove these items. • Make sure that your dryer is level.
Clothes are unevenly dried.	<ul style="list-style-type: none"> • Seams, pockets, and other similarly heavy areas may not be completely dry when the rest of the load has reached the selected dryness level. This is normal. Select the More Dry or Very Dry dryness level if desired. • If you dry one heavy item with a lightweight load (such as one towel with sheets), the heavy item may not be completely dry when the rest of the load has reached the selected dryness level. For best drying results, dry heavy items and lightweight items separately.
Dryer shuts off before the clothes are dried.	<ul style="list-style-type: none"> • The dryer load is too small. Add more items or a few towels and restart the cycle. • The dryer load is too large. Remove some items and restart the cycle. • Consider using a Manual Dry cycle.
Dryer has an odd odor.	<ul style="list-style-type: none"> • Your dryer draws air from the surrounding room air. Household odors from paint, varnish, strong cleaners, and so forth, may enter your dryer with the surrounding room air. This is normal. When these odors linger in the air, ventilate the room completely before using your dryer.
Clothing is still wrinkled after using the Wrinkle Care setting.	<ul style="list-style-type: none"> • Small loads of one to four items work best. • If the dryer load is too large, items cannot tumble freely. Try loading fewer items. • Make sure that the items in the dryer load are similar. The Wrinkle Care setting works best when the items in the dryer load are similar-type items.
There is lint on the clothing.	<ul style="list-style-type: none"> • Check pockets thoroughly before washing and drying clothes. Things like paper or tissue can break up into small pieces that turn into lint. • Clean the lint filter before every cycle. Some loads that produce high amounts of lint can clog the filter. • Some fabrics are lint producers (like a fuzzy white cotton towel) and they should be dried separately from clothes that are lint trappers (like a pair of black linen pants). • Divide larger loads into smaller loads for drying.

Understanding the error codes

Your dryer is equipped with an automatic error-monitoring system to detect and diagnose problems at an early stage. When an error occurs, the dryer beeps for five seconds every 15 minutes. After 24 hours, the dryer turns off automatically.

ERROR CODE	POSSIBLE CAUSE	SOLUTIONS
The Drying, Cooling, and Wrinkle Care (option) indicators blink.	A control circuit board malfunction has occurred.	Contact authorized service personnel for help. DO NOT use your dryer.
The Cooling, Wrinkle Care (process), and Wrinkle Care (option) indicators blink.	The humidity sensor failed.	Your dryer will complete the current operating cycle but items could be over dried. Your dryer can still operate under the Manual Dry cycles. Contact authorized service personnel for help.
The Wrinkle Care (process), Clean Filter, and Wrinkle Care (option) indicators blink.	The temperature sensor failed.	Contact authorized service personnel for help. DO NOT use your dryer.

Specifications

Dimensions (H x W x D)	41 3/4 x 27.0 x 30.0 in (105.9 x 68.6 x 76.2 cm)
Weight	Net: 121.3 lbs. (55 kg) Gross: 136.7 lbs. (62 kg)
Capacity	6.7 cu. ft.
Power	120V/240V AC, 60Hz
Heating rating	Electric: 4,800W Gas: 16,000 BTU/hr

ONE-YEAR LIMITED WARRANTY

Definitions:

The Distributor* of Insignia branded products warrants to you, the original purchaser of this new Insignia-branded product ("Product"), that the Product shall be free of defects in the original manufacturer of the material or workmanship for a period of one (1) year from the date of your purchase of the Product ("Warranty Period").

For this warranty to apply, your Product must be purchased in the United States or Canada from a Best Buy branded retail store or online at www.bestbuy.com or www.bestbuy.ca and is packaged with this warranty statement.

How long does the coverage last?

The Warranty Period lasts for 1 year (365 days) from the date you purchased the Product. Your purchase date is printed on the receipt you received with the Product.

What does this warranty cover?

During the Warranty Period, if the original manufacture of the material or workmanship of the Product is determined to be defective by an authorized Insignia repair center or store personnel, Insignia will (at its sole option): (1) repair the Product with new or rebuilt parts; or (2) replace the Product at no charge with new or rebuilt comparable products or parts. Products and parts replaced under this warranty become the property of Insignia and are not returned to you. If service of Products or parts are required after the Warranty Period expires, you must pay all labor and parts charges. This warranty lasts as long as you own your Insignia Product during the Warranty Period. Warranty coverage terminates if you sell or otherwise transfer the Product.

How to obtain warranty service?

If you purchased the Product at a Best Buy retail store location or from a Best Buy online website (www.bestbuy.com or www.bestbuy.ca), please take your original receipt and the Product to any Best Buy store. Make sure that you place the Product in its original packaging or packaging that provides the same amount of protection as the original packaging.

To obtain warranty service, in the United States and Canada call 1-877-467-4289. Call agents may diagnose and correct the issue over the phone.

Where is the warranty valid?

This warranty is valid only in the United States and Canada at Best Buy branded retail stores or websites to the original purchaser of the product in the country where the original purchase was made.

What does the warranty not cover?

This warranty does not cover:

- Food, beverage, and/or medicine loss/spoilage.
- Customer instruction/education
- Installation
- Set up adjustments
- Cosmetic damage
- Damage due to weather, lightning, and other acts of God, such as power surges
- Accidental damage
- Misuse
- Abuse
- Negligence
- Commercial purposes/use, including but not limited to use in a place of business or in communal areas of a multiple dwelling condominium or apartment complex, or otherwise used in a place of other than a private home.
- Modification of any part of the Product, including the antenna

- Display panel damaged by static (non-moving) images applied for lengthy periods (burn-in).
- Damage due to incorrect operation or maintenance
- Connection to an incorrect voltage or power supply
- Attempted repair by any person not authorized by Insignia to service the Product
- Products sold “as is” or “with all faults”
- Consumables, including but not limited to batteries (i.e. AA, AAA, C etc.)
- Products where the factory applied serial number has been altered or removed
- Loss or Theft of this product or any part of the product
- Display panels containing up to three (3) pixel failures (dots that are dark or incorrectly illuminated) grouped in an area smaller than one tenth (1/10) of the display size or up to five (5) pixel failures throughout the display. (Pixel based displays may contain a limited number of pixels that may not function normally.)
- Failures or Damage caused by any contact including but not limited to liquids, gels or pastes.

REPAIR REPLACEMENT AS PROVIDED UNDER THIS WARRANTY IS YOUR EXCLUSIVE REMEDY FOR BREACH OF WARRANTY. INSIGNIA SHALL NOT BE LIABLE FOR ANY INCIDENTAL OR CONSEQUENTIAL DAMAGES FOR THE BREACH OF ANY EXPRESS OR IMPLIED WARRANTY ON THIS PRODUCT, INCLUDING, BUT NOT LIMITED TO, LOST DATA, LOSS OF USE OF YOUR PRODUCT, LOST BUSINESS OR LOST PROFITS. INSIGNIA PRODUCTS MAKES NO OTHER EXPRESS WARRANTIES WITH RESPECT TO THE PRODUCT, ALL EXPRESS AND IMPLIED WARRANTIES FOR THE PRODUCT, INCLUDING BUT NOT LIMITED TO ANY IMPLIED WARRANTIES OF AND CONDITIONS OF MERCHANTABILITY AND FITNESS FOR A PARTICULAR PURPOSE, ARE LIMITED IN DURATION TO THE WARRANTY PERIOD SET FORTH ABOVE AND NO WARRANTIES, WHETHER EXPRESS OR IMPLIED, WILL APPLY AFTER THE WARRANTY PERIOD. SOME STATES, PROVINCES AND JURISDICTIONS DO NOT ALLOW LIMITATIONS ON HOW LONG AN IMPLIED WARRANTY LASTS, SO THE ABOVE LIMITATION MAY NOT APPLY TO YOU. THIS WARRANTY GIVES YOU SPECIFIC LEGAL RIGHTS, AND YOU MAY ALSO HAVE OTHER RIGHTS, WHICH VARY FROM STATE TO STATE OR PROVINCE TO PROVINCE.

Contact Insignia:

1-877-467-4289

www.insigniaproducts.com

INSIGNIA is a trademark of Best Buy and its affiliated companies.

*Distributed by Best Buy Purchasing, LLC

7601 Penn Ave South, Richfield, MN 55423 U.S.A

©2022 Best Buy. All rights reserved.

INSIGNIA™

www.insigniaproducts.com

1-877-467-4289 (U.S. and Canada)

INSIGNIA is a trademark of Best Buy and its affiliated companies.

Distributed by Best Buy Purchasing, LLC

7601 Penn Ave South, Richfield, MN 55423 U.S.A.

©2022 Best Buy. All rights reserved.

V4 ENGLISH
22-0877