

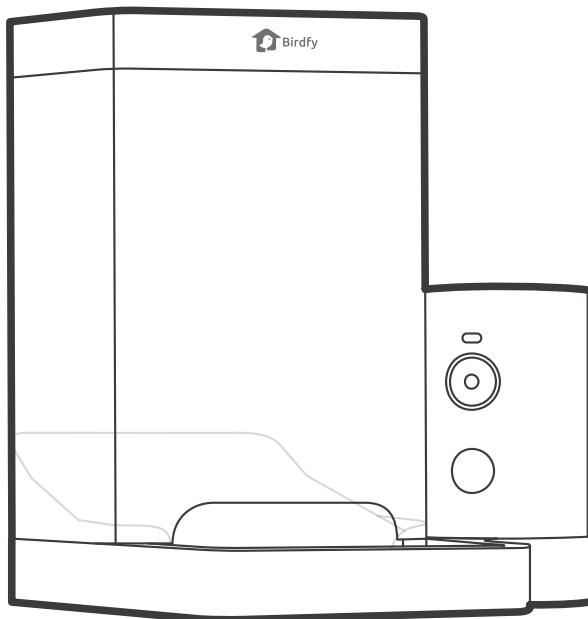

User Manual

Birdfy Feeder Rookie



EN

ES

FR

Catalog

PRODUCT OVERVIEW

What's in the Box	1-4
Product Diagram	5-6

CAMERA GUIDE

Camera Diagram	7-8
Charge Before Use	9
Camera Status Light	10-12

INSTALLATION AND USE

Step 1: Download the Birdfy App	13
Step 2: Pair the Camera with the App	13-14
Step 3: Assemble the Product	15-16
Step 4: Outdoor Installation	17-21
Step 5: Add Birdseed	22

MAINTENANCE

Cleaning	23-24
----------------	-------

SUPPORT AND COMMUNITY

Support	25-28
The Birdfy Community	29-30

WARNING	31-36
----------------------	-------

Catálogo

DESCRIPCIÓN DEL PRODUCTO

Qué hay en la caja	1-4
Diagrama del producto	5-6

GUÍA DE LA CÁMARA

Diagrama de la cámara	7-8
Cargar antes de usar	9
Luz de estado de la cámara	10-12

INSTALACIÓN Y USO

Paso 1: Descargar la aplicación Birdfy	13
Paso 2: Vincular la cámara con la aplicación	13-14
Paso 3: Ensamblar el producto	15-16
Paso 4: Instalación en exteriores	17-21
Paso 5: Añadir alpiste	22

MANTENIMIENTO

Limpieza	23-24
----------------	-------

SOPORTE Y COMUNIDAD

Soporte	25-28
La Comunidad Birdfy	29-30

ADVERTENCIA	31-36
--------------------------	-------

Catalogue

PRÉSENTATION DU PRODUIT

Contenu de la boîte	1-4
Schéma du produit	5-6

GUIDE DE LA CAMÉRA

Schéma de la caméra	7-8
Charger avant utilisation	9
Le voyant d'état de la caméra	10-12

INSTALLATION ET UTILISATION

Étape 1 : Télécharger l'application Birdfy	13
Étape 2 : Appairer la caméra avec l'application	13-14
Étape 3 : Assembler le produit	15-16
Étape 4 : Installation en extérieur	17-21
Étape 5 : Ajouter des graines pour oiseaux	22

ENTRETIEN

Nettoyage	23-24
-----------------	-------

SUPPORT ET COMMUNAUTÉ

Assistance	25-28
La Communauté Birdfy	29-30

AVERTISSEMENT	31-36
----------------------------	-------

What's in the Box



User Manual
Manual del usuario
Manuel de l'utilisateur

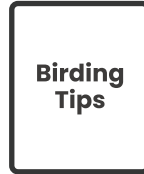

Birding Tips
Tips de aves
Astuces oiseaux

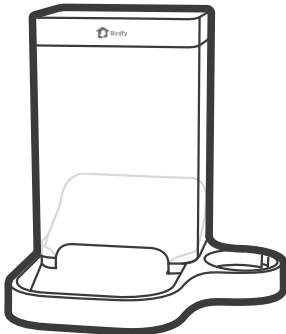

Feeder
Alimentador
Mangeoire

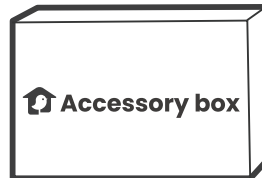
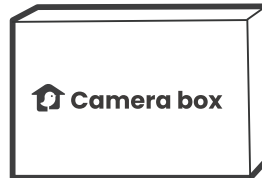

Camera box & Accessory box
Caja de cámara & Caja de accesorios
Boîte d'appareil photo & Boîte d'accessoires

PRODUCT OVERVIEW



Charging cable
Cable de carga
Câble de chargement



Camera
Cámara
Caméra



Camera box
Caja de cámara
Boîte d'appareil photo

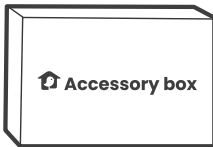

Accessory box
Caja de accesorios
Boîte d'accessoires

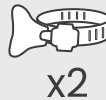

Hose clips
Clips para manguera
Clips pour tuyau

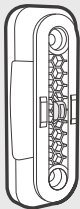

Hanging bracket
Soporte de suspensión
Support de suspension



Drilling template
Plantilla de perforación
Gabarit de perçage

PRODUCT OVERVIEW

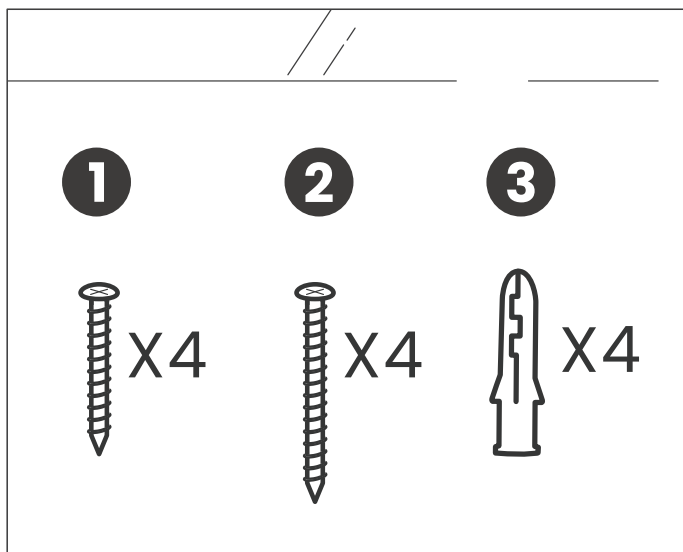

1 Screws for mounting on concrete
Tornillos para montaje en hormigón
Vis pour montage sur béton

3 Anchors
Anclajes
Chevilles

2 Screws for mounting on wood
Tornillos para montaje en madera
Vis pour montage sur bois

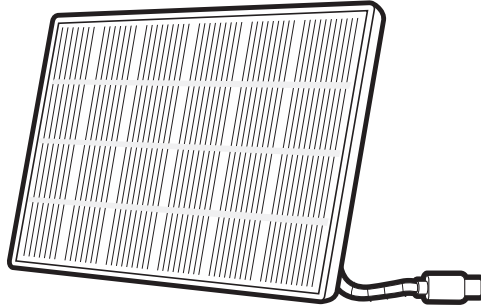

Solar panel*

*Please note that if you ordered the no-solar bundle, your package will not include a solar panel.

Panel solar*

*Tenga en cuenta que si pidió el paquete sin panel solar, su paquete no incluirá un panel solar.

Panneau solaire*

*Veuillez noter que si vous avez commandé le forfait sans panneau solaire, votre colis n'inclura pas de panneau solaire.

Product Diagram

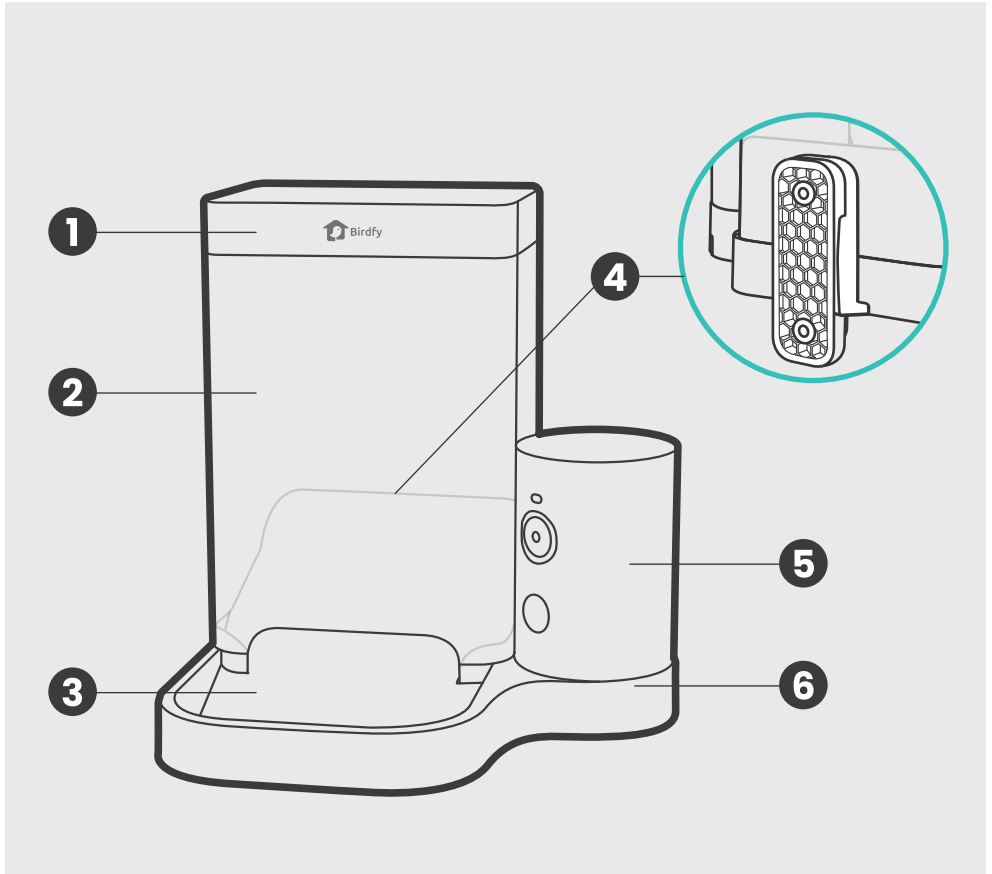

- 1** Roof
Techo
Toit
- 2** Seed bin
Contenedor de semillas
Bac à graines
- 3** Feeding tray
Bandeja de alimentación
Plateau d'alimentation
- 4** Mounting bracket
Soporte de montaje
Support de montage
- 5** Camera
Cámara
Caméra
- 6** Camera bracket
Soporte de cámara
Support de caméra

Camera Diagram

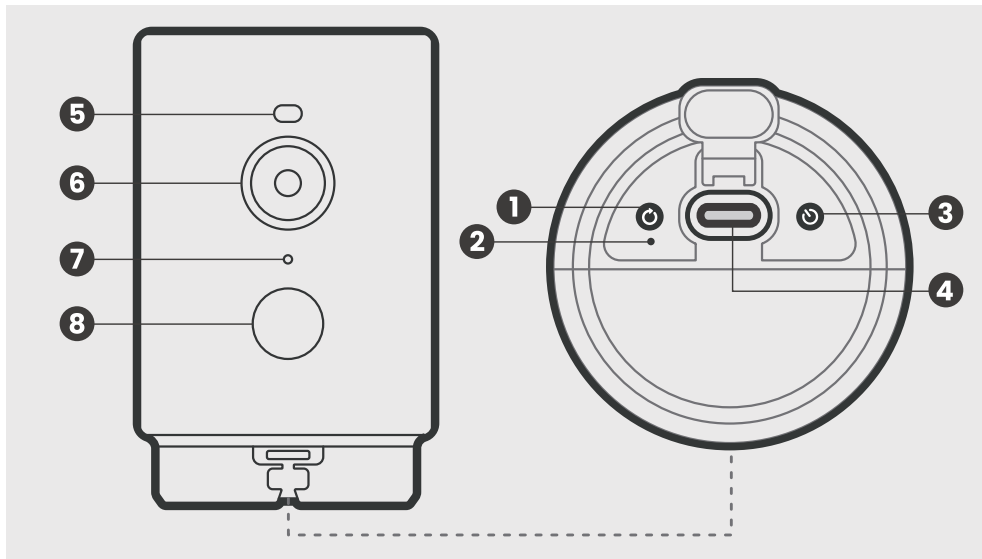

1 Reboot button
Botón de reinicio
Bouton de redémarrage

2 Status light
Luz de estado
Le voyant d'état

3 Power button
Botón de encendido
Bouton d'alimentation

4 Charging port
Puerto de carga
Port de charge

5 White light
Luz blanca
Lumière blanche

7 Microphone
Micrófono
Microphone

6 Camera lens
Lente de la cámara
Objectif de la caméra

8 Motion sensor
Sensor de movimiento
Capteur de mouvement

Charge Before Use

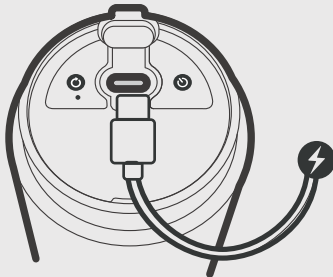

Fully charge the camera before use

For safety reasons, the camera is not fully charged when packaged. Please use the included charging cable (DC 5V / 1.5A) found in the camera box to fully charge the camera before first use.





Cargue completamente la cámara antes de usarla

Por razones de seguridad, la cámara no está completamente cargada cuando se empaqueta. Por favor, utilice el cable de carga incluido (DC 5V / 1.5A) que se encuentra en la caja de accesorios para cargar completamente la cámara antes del primer uso.

Chargez complètement la caméra avant de l'utiliser

Pour des raisons de sécurité, la caméra n'est pas complètement chargée lorsqu'elle est emballée. Veuillez utiliser le câble de charge inclus (DC 5V / 1.5A) situé dans la boîte d'accessoires pour charger complètement la caméra avant la première utilisation.

Camera Status Light

Status Light Luz de estado Le voyant d'état	Description Descripción Description
 <p>Solid red Rojo sólido Rouge fixe</p>	<p>Charging Cargando En charge</p>
 <p>None Ninguno Aucune lumière</p>	<p>Fully charged / Power off Completamente cargado / Apagado Complètement chargé / Éteint</p>
 <p>Solid blue Azul sólido Bleu fixe</p>	<p>Working Funcionando En fonctionnement</p>
 <p>Flashing blue Azul intermitente Bleu clignotant</p>	<p>Wi-Fi Config Mode Modo de configuración Wi-Fi Mode de configuration Wi-Fi</p>



No Light
Sin luz
Aucune lumière

What to Do if There Is No Light

Press the power button once to check the status:

- If the blue light turns on briefly and then goes off: Your device is in Sleep Mode. It is still on and functioning in the background to save power.
- If there is no response: Your device is Powered Off. To turn it on, press and hold the power button for 3 seconds.

Qué hacer si no hay luz

Presiona una vez el botón de encendido para comprobar el estado:

- Si la luz azul se enciende brevemente y luego se apaga: El dispositivo está en modo de suspensión. Sigue funcionando en segundo plano para ahorrar energía.
- Si no hay respuesta: El dispositivo está apagado. Para encenderlo, mantén presionado el botón de encendido durante 3 segundos.

Que faire s'il n'y a pas de lumière

Appuyez une fois sur le bouton d'alimentation pour vérifier l'état :

- Si la lumière bleue s'allume brièvement puis s'éteint : L'appareil est en mode veille. Il reste actif en arrière-plan pour économiser de l'énergie.
- Si aucune réaction : L'appareil est éteint. Pour l'allumer, maintenez le bouton d'alimentation enfoncé pendant 3 secondes.



When charging and operating, both the ambient temperature and camera temperature should be within 14°F to 113°F (-10°C to 45°C). If the camera has been exposed to low temperatures for an extended period, it should be brought back to room temperature before charging.

Durante la carga y el funcionamiento, tanto la temperatura ambiente como la de la cámara deben estar entre 14°F y 113°F (-10°C a 45°C). Si la cámara ha estado expuesta a bajas temperaturas durante un período prolongado, debe llevarse a temperatura ambiente antes de cargarla.

Lors de la charge et de l'utilisation, la température ambiante et celle de la caméra doivent se situer entre 14°F et 113°F (-10°C à 45°C). Si la caméra a été exposée à des températures basses pendant une période prolongée, elle doit être ramenée à température ambiante avant la recharge.

Step 1: Downloading the Birdfy App



Step 2: Pair the Camera with the App

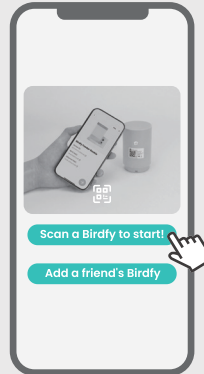
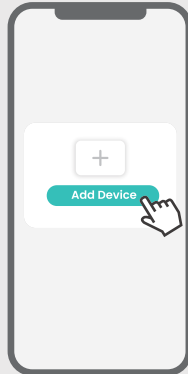

- *Follow the in-app instructions to set up your Birdfy
- *Sigue las instrucciones en la aplicación para configurar tu Birdfy
- *Suivez les instructions dans l'application pour configurer votre Birdfy

Bird Identification

- If you have the Birdfy Feeder Rookie with Lifetime Free AI, the AI bird identification feature is included and activated automatically, no further action needed.
- If you have the Birdfy Feeder Rookie with AI by Subscription, you need to subscribe on my.birdfy.com to access this feature.

Identificación de aves

- Si tienes el Birdfy Feeder Rookie con IA gratuita de por vida, la función de identificación de aves mediante IA está incluida y se activa automáticamente, no se requiere ninguna acción adicional.
- Si tienes el Birdfy Feeder Rookie con IA suscribible, debes suscribirte en my.birdfy.com para acceder a esta función.

Identification des oiseaux

- Si vous avez le Birdfy Feeder Rookie avec l'IA gratuite à vie, la fonction d'identification des oiseaux par IA est incluse et activée automatiquement, aucune action supplémentaire n'est nécessaire.
- Si vous avez le Birdfy Feeder Rookie avec l'IA par abonnement, vous devez vous abonner sur my.birdfy.com pour accéder à cette fonctionnalité.

Step 3: Assemble the Product

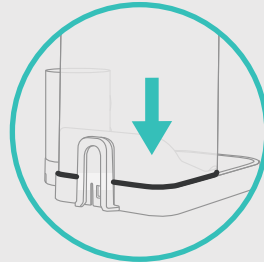
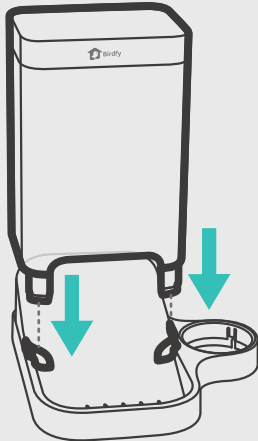

Ensure the seed bin and base are securely fastened with no gaps, and listen for a "click" to confirm.

1

Align the bottom of the seed bin with the feeding tray, and attach it to the tray.

Alinee la parte inferior del contenedor de semillas con la bandeja de alimentación y fíjelo a la bandeja.

Alignez le bas du bac à graines avec le plateau d'alimentation et fixez-le au plateau.

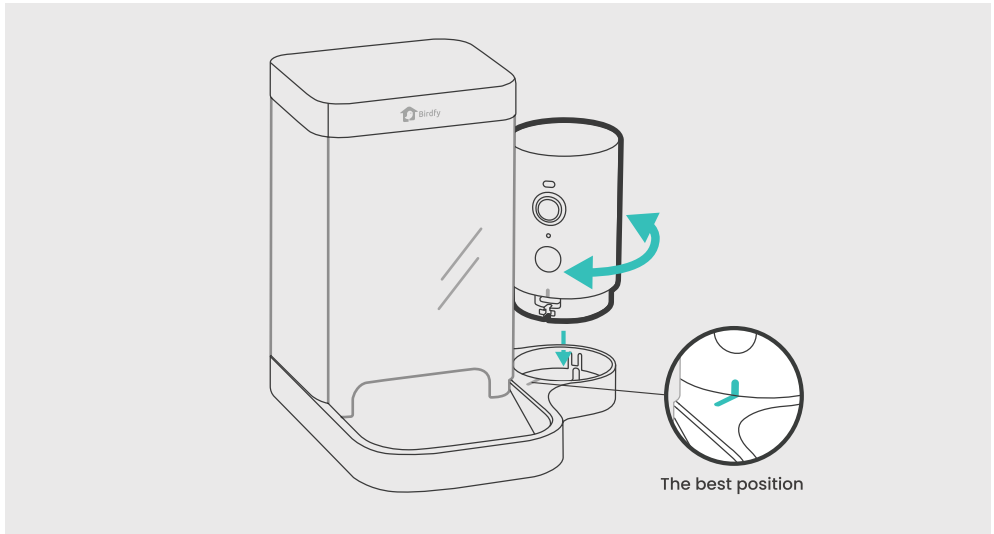

2

Mount the camera onto the bracket. Adjust the camera angle as you like. For the best viewing position, align the mark on the camera with that on the camera base.

Monte la cámara en el soporte. Ajuste el ángulo de la cámara como desee. Para obtener la mejor vista, alinee la marca de la cámara con la de la base de la cámara.

Fixez la caméra sur le support. Réglez l'angle de la caméra comme vous le souhaitez. Pour une meilleure vue, alignez le repère sur la caméra avec celui sur la base de la caméra.

Step 4: Outdoor Installation

A. Pole-mounted

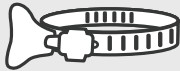

Hose clips
Clips para manguera
Clips pour tuyau

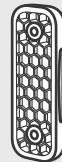

Hanging bracket
Soporte de suspensión
Support de suspension

1

Loosen the hose clip.
Afloje la abrazadera de
manguera.
Desserrez le clip de tuyau.

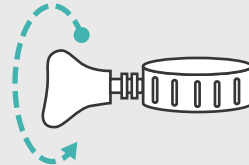

2

Wrap the hose clip around the bracket.

Enrolle la abrazadera de manguera alrededor del soporte.

Enroulez le clip de tuyau autour du support.

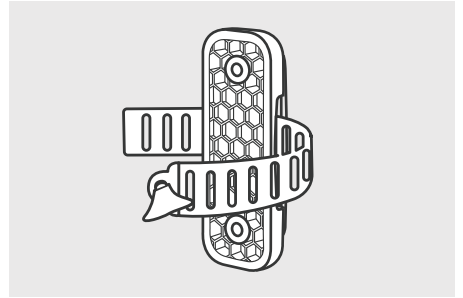

3

Attach the bracket to the pole.

Sujete el soporte al poste.

Fixez le support au poteau.

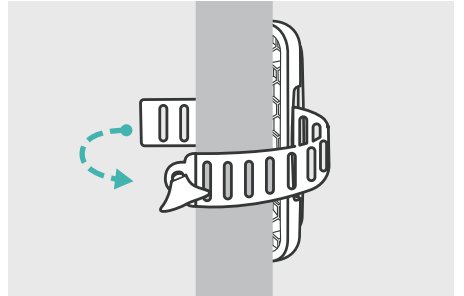

4

Hang the feeder on the pole.

Cuelgue el comedero en el poste.

Accrochez le mangeoire sur le poteau.

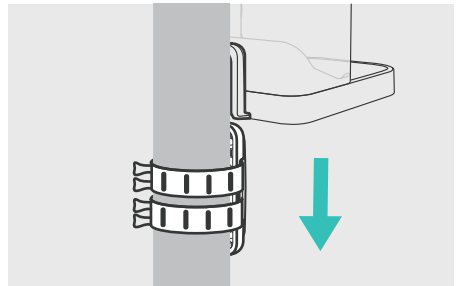

B. Wall-mounted



Anchors
Anclajes
Chevilles



Drilling template
Plantilla de perforación
Gabarit de perçage



Hanging bracket
Soporte de suspensión
Support de suspension



Screws for mounting on concrete
Tornillos para montaje en hormigón
Vis pour montage sur béton



Screws for mounting on wood
Tornillos para montaje en madera
Vis pour montage sur bois

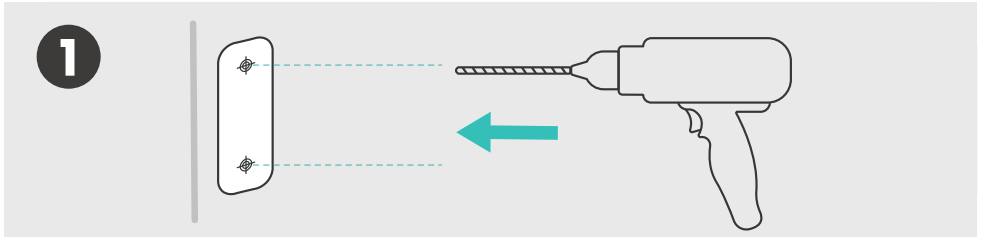

Use the drill template and an electric drill (15/64", 6mm) to drill two holes.
 Usa la plantilla de perforación y un taladro eléctrico (15/64", 6 mm) para hacer dos agujeros.
 Utilisez le gabarit de perçage et une perceuse électrique (15/64", 6 mm) pour percer deux trous.

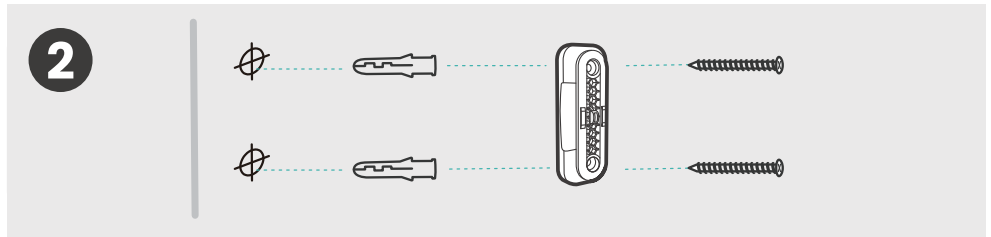

Drive the provided plastic anchors into the holes. Skip this step if you are mounting on wood. Next, fasten the hanging bracket on the wall using the screws.
 Inserte los anclajes de plástico proporcionados en los agujeros. Salte este paso si está montando sobre madera. Luego, sujete el soporte de suspensión a la pared con los tornillos.
 Enfoncez les chevilles en plastique fournies dans les trous. Passez cette étape si vous fixez sur du bois. Ensuite, fixez le support de suspension au mur avec les vis.

INSTALLATION AND USE

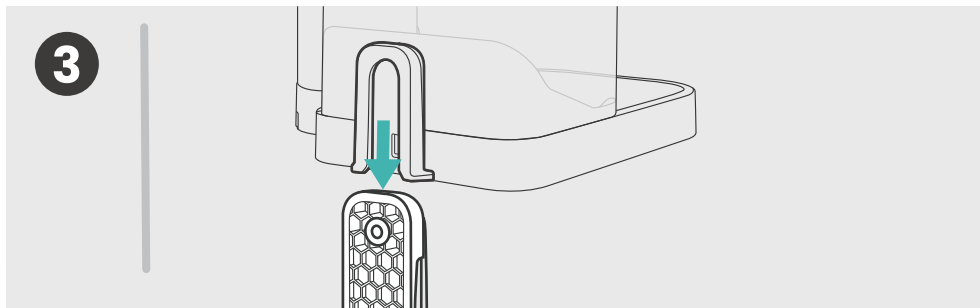

Hang the feeder on the wall.

Cuelga el comedero en la pared.

Accrochez la mangeoire au mur.

Step 5: Add Birdseed

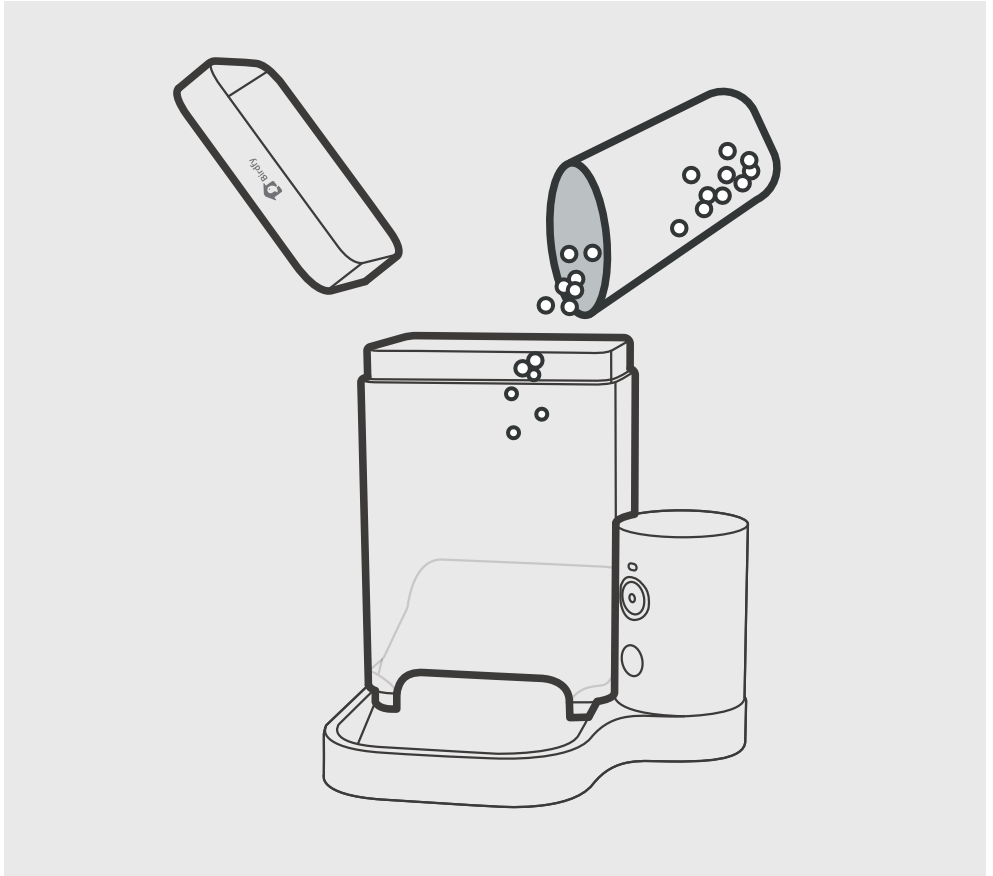

Cleaning

1

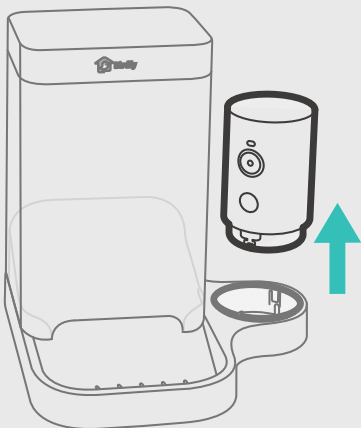

Lift the camera straight up to detach it from the bracket.

Levante la cámara recta hacia arriba para desprenderla del soporte.

Soulevez la caméra droit vers le haut pour la détacher du support.

2

Push

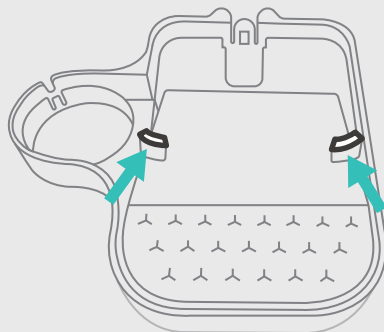

Turn the feeder upside down and press the two snap-fits.

Voltee el alimentador boca abajo y presione las dos lengüetas de ajuste.

Retournez le distributeur et appuyez sur les deux clips.



Pull the seed bin downward to remove it from the base.

Tire de la bandeja de semillas hacia abajo para separarla de la base.

Tirez le bac à graines vers le bas pour le retirer de la base.



Use a brush and water to clean the seed bin and base.

Use un cepillo y agua para limpiar el contenedor de semillas y la base.

Utilisez une brosse et de l'eau pour nettoyer le bac à graines et la base.

Support

We are dedicated to offering top-notch products and services to our customers. Should you **encounter any issues with your Birdfy, please don't hesitate to reach out to us.**

✉ Email: support@birdfy.com (Global)

☎ Phone: 1(866)749-0567 (US Only)

💬 In-App Chat (Global)

Nos dedicamos a ofrecer productos y servicios de primera calidad a nuestros clientes. **Si tiene algún problema con su Birdfy, no dude en contactarnos.**

✉ Correo electrónico: support@birdfy.com (Global)

☎ Teléfono: 1(866)749-0567 (solo EE. UU.)

💬 Chat en la aplicación (Global)

Nous nous engageons à offrir des produits et services de qualité supérieure à nos clients. **Si vous rencontrez des problèmes avec votre Birdfy, n'hésitez pas à nous contacter.**

✉ E-mail : support@birdfy.com (Global)

☎ Téléphone : 1(866)749-0567 (États-Unis uniquement)

💬 Chat intégré à l'application (Global)

If your Birdfy camera **goes offline or fails to stream**, try these troubleshooting steps:

- 1. Ensure the camera is fully charged.**
- 2. Verify your home Wi-Fi connectivity. Try to reconnect the camera to your Wi-Fi network.**

Si tu cámara Birdfy **se desconecta o no puede transmitir**, prueba estos pasos de resolución de problemas:

- 1. Asegúrate de que la cámara esté completamente cargada.**
- 2. Verifica la conectividad de tu red Wi-Fi doméstica. Intenta reconectar la cámara a tu red Wi-Fi.**



Birdfy Help Center

Si votre caméra Birdfy **se déconnecte ou ne parvient pas à diffuser**, suivez ces étapes de dépannage :

- 1. Assurez-vous que la caméra est complètement chargée.**
- 2. Vérifiez la connectivité de votre réseau Wi-Fi domestique. Essayez de reconnecter la caméra à votre réseau Wi-Fi.**

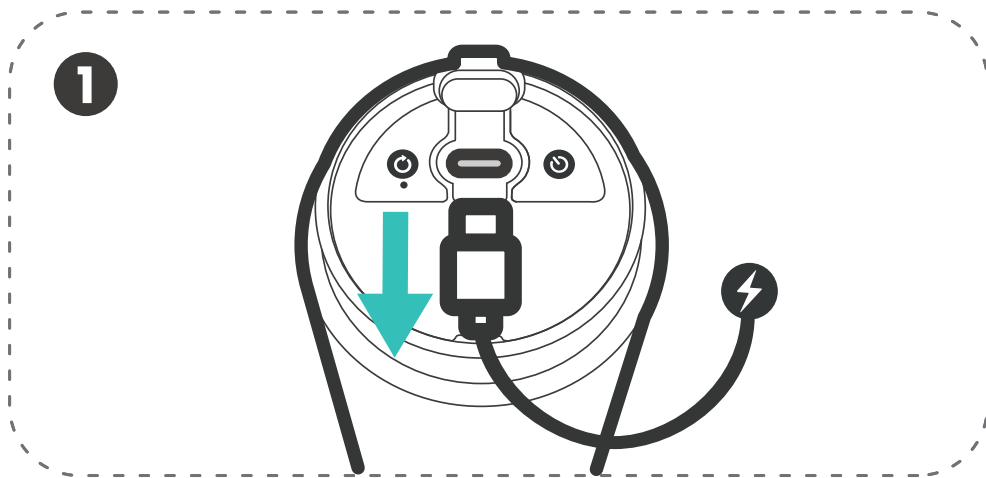

Disconnect the camera from the solar panel or charger.
Desconecta la cámara del panel solar o del cargador.
Débranchez la caméra du panneau solaire ou du chargeur.

Press the reboot button for 1 second to power down the camera completely.

Presione el botón de reinicio durante 1 segundo para apagar completamente la cámara.

Appuyez sur le bouton de redémarrage pendant 1 seconde pour éteindre complètement la caméra.

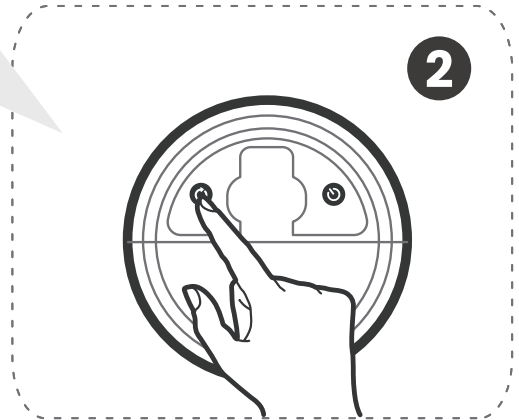

Press and hold the power button for 3 seconds to restart the camera.

Mantén presionado el botón de encendido durante 3 segundos para reiniciar la cámara.

Maintenez le bouton d'alimentation enfoncé pendant 3 secondes pour redémarrer la caméra.

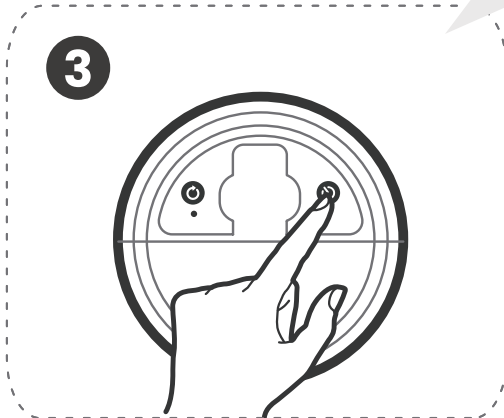

The Birdfy Community

Scan the QR code to join our vibrant Facebook community and connect with fellow bird enthusiasts! Discover valuable insights on birdwatching and bird feeding techniques, exchange your finest Birdfy captures, and witness exotic birds from around the world!

Escanee el código QR para unirse a nuestra vibrante comunidad de Facebook y conectarse con otros entusiastas de las aves. Descubra información valiosa sobre observación de aves y técnicas de alimentación, intercambie sus mejores capturas de Birdy y observe aves exóticas de todo el mundo.

Scannez le code QR pour rejoindre notre communauté Facebook dynamique et vous connecter avec d'autres passionnés d'oiseaux! Découvrez des informations précieuses sur l'observation des oiseaux et les techniques d'alimentation, partagez vos meilleures captures Birdy et contemplez des oiseaux exotiques du monde entier !



@birdfy by netvue

Warning

FCC Statement

Note: This equipment has been tested and found to comply with the limits for a Class B digital device, pursuant to part 15 of the FCC Rules. These limits are designed to provide reasonable protection against harmful interference in a residential installation. This equipment generates, uses and can radiate radio frequency energy and, if not installed and used in accordance with the instructions, may cause harmful interference to radio communications. However, there is no guarantee that interference will not occur in a particular installation. If this equipment does cause harmful interference to radio or television reception, which can be determined by turning the equipment off and on, the user is encouraged to try to correct the interference by one or more of the following measures:

- Reorient or relocate the receiving antenna.
- Increase the separation between the equipment and receiver.
- Connect the equipment into an outlet on a circuit different from that to which the receiver is connected.
- Consult the dealer or an experienced radio/TV technician for help.

This device complies with part 15 of the FCC Rules. Operation is subject to the following two conditions: (1) This device may not cause harmful interference, and (2) this device must accept any interference received, including interference that may cause undesired operation.

Any changes or modifications made without explicit approval from the responsible party in compliance may result in the user being unauthorized to operate the device.

This device meets the FCC radiation exposure limits for uncontrolled environments. To

ensure safe installation and operation, maintain a minimum distance of 20cm between the radiator and your body.

FCC ID: 2BC96NB-CMA01

CE Statement

The information provided on the packaging is allowed to identify geographical areas within the member states where restrictions on use or requirements for authorized use exist, if applicable.

The structure of the product allows it to be used in at least one member state without violating applicable requirements for the use of radio spectrum.

Manufacturer information:

NETVUE INC.

1055 East Colorado Boulevard 5th Floor
Pasadena, CA, 91106

IC Statement

This device contains licence-exempt transmitter(s)/receiver(s) that comply with Innovation, Science and Economic Development Canada's licence-exempt RSS(s). Operation is subject to the following two Economic Development Canada's licence-exempt RSS(s).

Operation is subject to the following two conditions:

- (1) This device may not cause interference.
- (2) This device must accept any interference, including interference that may cause undesired operation of the device.

L'émetteur/récepteur exempt de licence contenu dans le présent appareil est conforme aux CNR d'Innovation, Sciences et Développement économique Canada applicables aux appareils radio exempts de licence. L'exploitation est autorisée aux deux conditions

WARNING

suivantes:

1. L'appareil ne doit pas produire de brouillage;
2. L'appareil doit accepter tout brouillage radioélectrique subi, même si le brouillage est susceptible d'en compromettre le fonctionnement.

This equipment complies with IC radiation exposure limits set forth for an uncontrolled environment. This transmitter must not be co-located or operating in conjunction with any other antenna or transmitter. This equipment should be installed and operated with a minimum distance of 20cm between the radiator and your body.

Cet équipement respecte les limites d'exposition au rayonnement IC établies pour un environnement non contrôlé.

Cet émetteur ne doit pas être localisé ou fonctionner en conjonction avec une autre antenne ou un autre émetteur. Cet équipement doit être installé et utilisé à une distance minimale de 20cm entre le radiateur et votre corps.

Icamera International Trading Co., Ltd
Unit G25 Waterfront Studios
1 Dock Road, London, United Kingdom
support@birdfy.com



eVatmaster Consulting GmbH
Raiffeisen Street 2B11, 63110,
Rodgau, Hessen, Germany
support@birdfy.com



NETVUE INC.
1055 East Colorado Boulevard,
5th Floor, Pasadena, CA, 91106
+1(866)749-0567
support@birdfy.com



*These addresses are NOT intended for returns. If you have any questions regarding returns or repairs, please contact us at **support@birdfy.com**.

*Estas direcciones no están destinadas para devoluciones. Si tienes alguna pregunta sobre devoluciones o reparaciones, contáctanos en **support@birdfy.com**.

*Ces adresses ne sont pas destinées aux retours. Si vous avez des questions concernant les retours ou les réparations, veuillez nous contacter à **support@birdfy.com**.

WARNING



1. Contains batteries, keep away from fire.
2. Battery withstandable use/storage/transport temperature: 14–113°F (-10–45°C).
3. Replacing the battery with an incorrect type may cause a safety hazard.
4. Disposing of battery in fire/oven, or crushing/cutting it, may cause explosion.

1. Contiene baterías, mantener alejado del fuego.
2. Temperatura soportada por la batería para uso, almacenamiento o transporte: 14–113°F (-10–45°C).
3. Reemplazar la batería con un tipo incorrecto puede representar un riesgo de seguridad.
4. Desechar la batería en fuego/horno o aplastarla/cortarla puede causar una explosión.

1. Contient des piles, tenir à l'écart du feu.
2. Température supportée par la batterie en utilisation, stockage ou transport : -10–45°C (14–113°F).
3. Remplacer la batterie par un type incorrect peut présenter un danger pour la sécurité.
4. Jeter la batterie au feu/au four ou l'écraser/la couper peut provoquer une explosion.

Brand: Birdfy

Product Name: Birdfy Feeder Rookie

Model: NB-FP001

Camera Name: Birdfy Cam BA3A

Camera Model: NB-CMA01

FCC ID: 2BC96NB-CMA01

IC: 31482-NBCMA01

Manufacturer: NETVUE INC.

1055 East Colorado Boulevard 5th Floor,

Pasadena, CA, 91106

+1(866) 749-0567

support@birdfy.com

Made in China

Designed in USA



Raccolta Carta





Contact us



support@birdfy.com
(Global)



In-App Chat
(Global)



1(866)749-0567
(US Only)

www.birdfy.com
© Netvue Inc.