

QUICK SETUP GUIDE

32" 60Hz LED TV

NS-32DF310NA19

INCLUDED ACCESSORIES

Voice Remote with Alexa
and two AAA batteries



TV stands

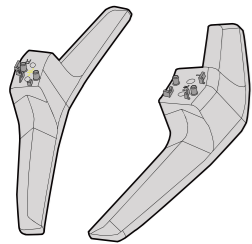

Self tapping screws
(4 mm x 16 mm length)
(4 pcs.)

Power cord

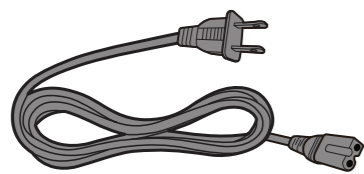

1 INSTALLING THE STANDS OR A WALL MOUNT

Place your TV face-down on a cushioned, clean surface.

STANDS

- 1 Align the TV stand screw holes with the holes on your TV's bottom.
- 2 Use a Phillips screwdriver and provided screws to secure each stand to your TV.

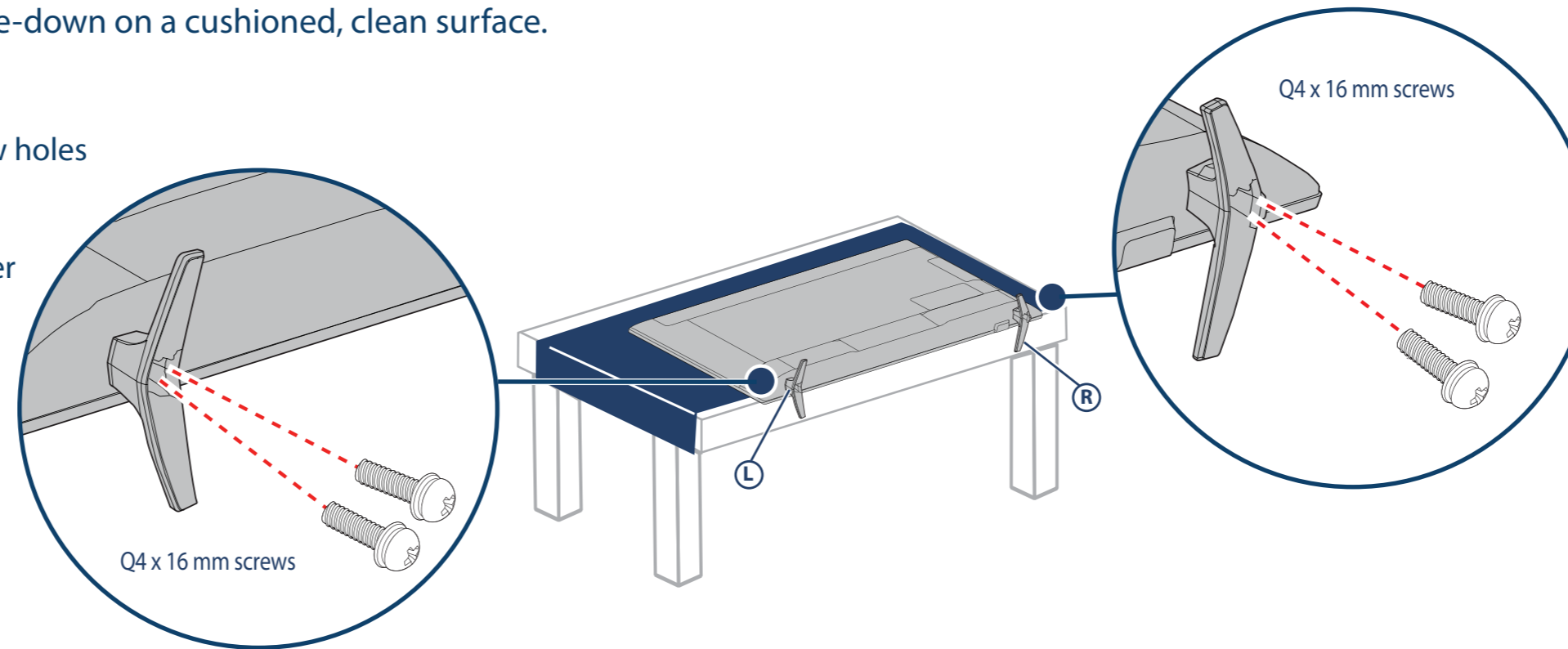

WALL MOUNT

Before you mount your TV, make sure that:

- You remove the stands.
- The wall-mount bracket supports the weight of your TV.

See the instructions that came with your wall mount for more information about how to correctly mount your TV.

WARNING: Your TV has four VESA mounting holes on the back.

You must secure a wall-mount bracket to all four holes.

If you do not use all four holes, your TV may fall and cause property damage or personal injury.

Note: Wall-mount screws are not included.

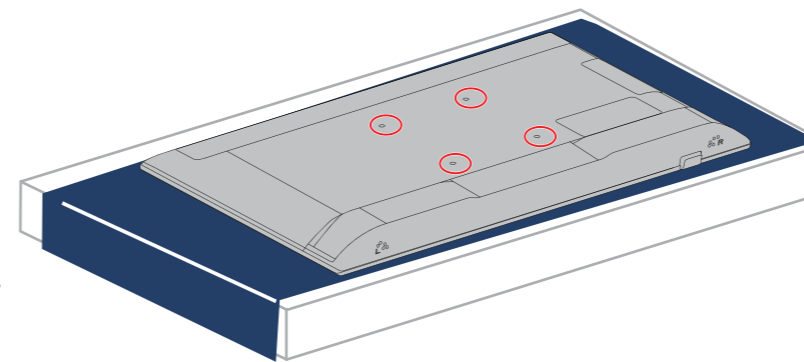

VESA Mounting Pattern

100 x 100 mm
Screws: type M4, 12 mm to 20 mm length depending on the wall mount

FEATURES

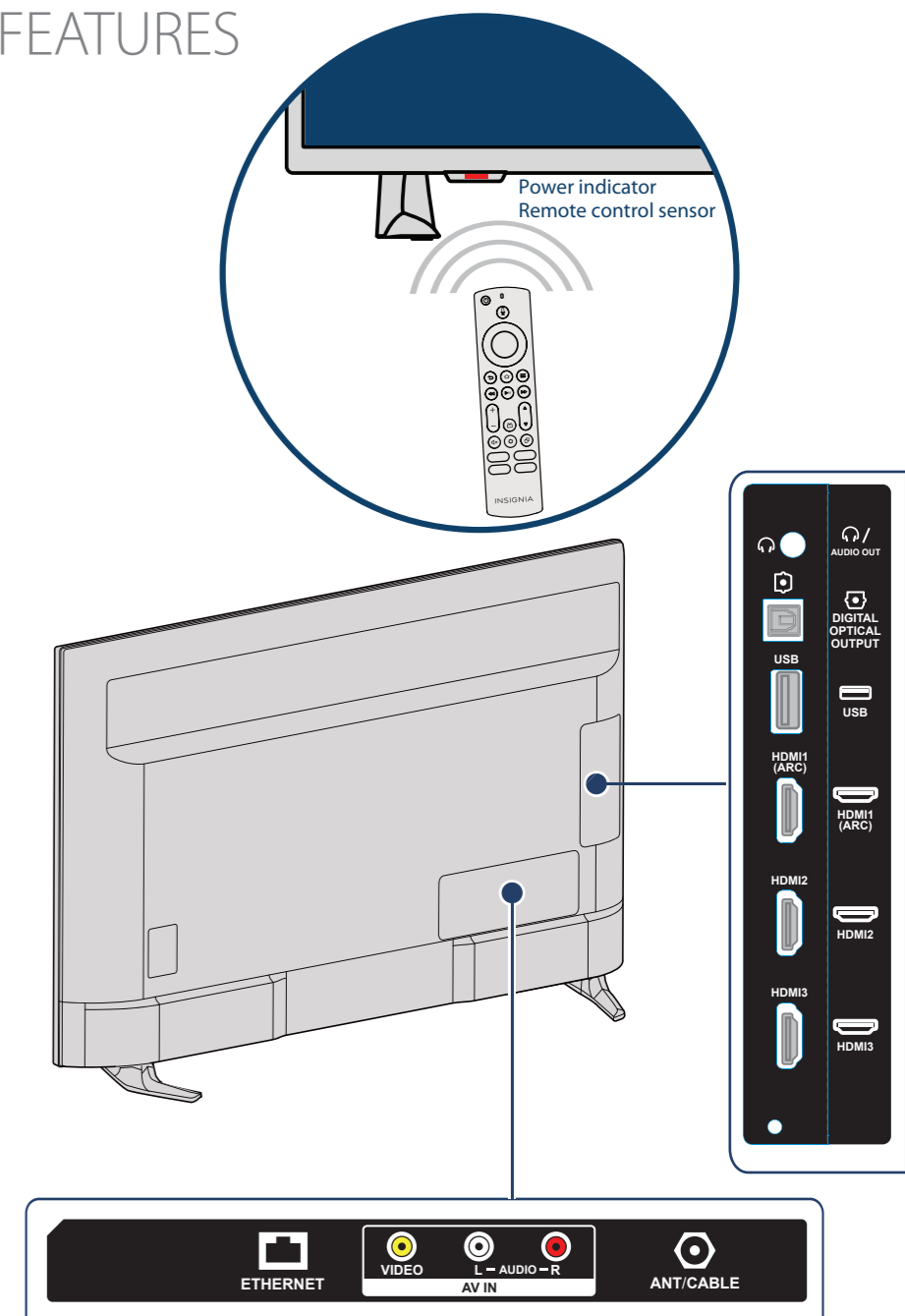

Note: Images do not necessarily represent the exact design of your television.

2 MAKING CONNECTIONS

HDMI (best video quality)

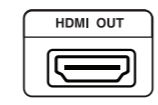

Note: You can use the **HDMI 1 (ARC)** jack to connect a digital audio system.

AV (good video quality)



Coaxial (good video quality)

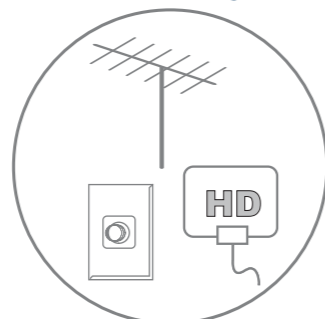

Connect an antenna to access live over-the-air TV.

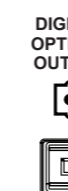
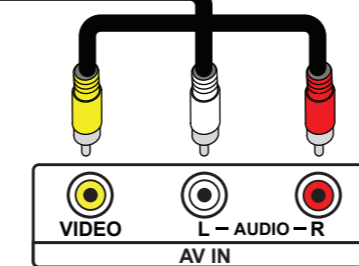
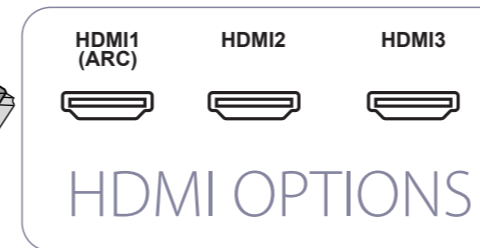

ANALOG

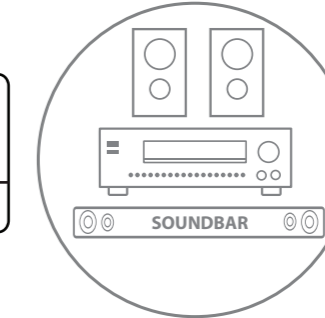
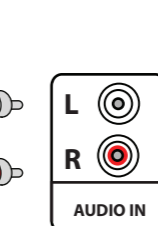

AUDIO OPTIONS

DIGITAL

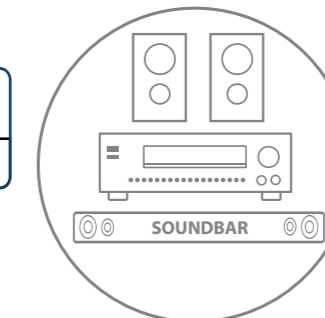
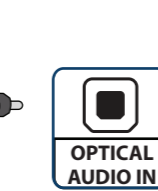

You can use the **DIGITAL OPTICAL OUTPUT** jack or the **HDMI 1 (ARC)** jack.
Note: If you need to change the digital audio format, go to the **Home** menu, select **Settings**, then select **Display & Sounds**. Select **Audio Output**, then select **Digital Audio Format** and change the setting to **PCM**.

ETHERNET (optional)



Note: You can use a wired Ethernet connection to access the internet, instead of a WiFi connection. Plug an Ethernet cable into the **ETHERNET** jack on your TV and your Ethernet connection.

STOP

Before using your new product, please read these instructions to prevent any damage.
Do not plug your power cord in until all other devices have been connected.

3 TURNING ON YOUR TV

1 Plug the power cord into the back of your TV and a power outlet.

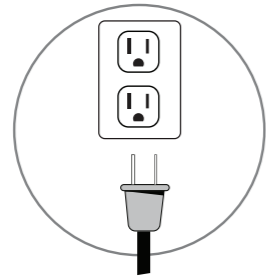

2 Remove the remote control cover and install the batteries.

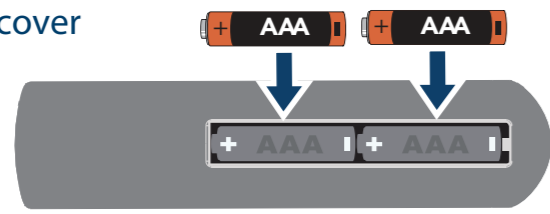

3 Press  on your remote.

4 Follow the on-screen instructions.

4 COMPLETE THE ON-SCREEN SETUP

Your TV should automatically pair to your new Voice Remote with Alexa.

1 If your remote is not paired, press . If you continue to have issues, re-insert or replace the batteries and try again.

2 Select your Wi-Fi network from the displayed network list.

Note: If your Wi-Fi network is password protected, enter your network password using the on-screen keyboard. If your network is hidden, select the **Join Other Network** tile.

3 Select your experience: **Full** (recommended) or **Basic**.

- Select **Full** to access live TV, over tens of thousands of streaming movies and TV episodes, thousands of apps, and Alexa skills. To get started, sign in to or sign up for a free Amazon account.

- Select **Basic** to access live TV and the six preset streaming apps. Alexa and the full Appstore are not included.

4 If you connected your TV to an antenna or cable wall jack:

A Go to **Settings > Live TV > Channel Scan**.

B Follow the on-screen instructions to scan for channels.

Note: To browse and watch live TV, use the **On Now** row or press  on your remote.

USING YOUR VOICE REMOTE WITH ALEXA

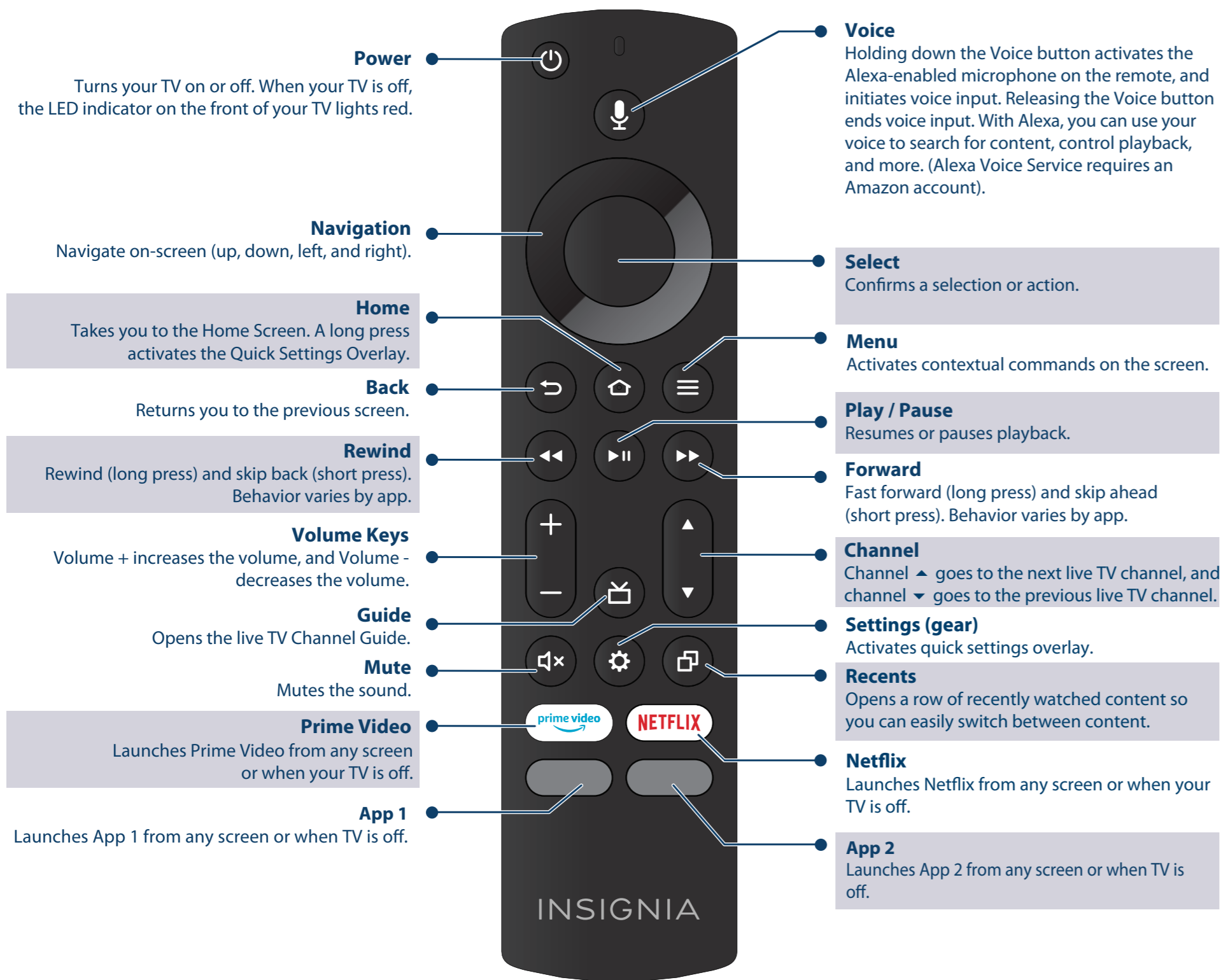

FIND YOUR USER GUIDE ONLINE

- 1 Go to www.insigniaproducts.com.
- 2 Use the search bar to find **NS-32DF310NA19**.
- 3 Select **Support & Downloads**.
- 4 Next to *User Guide*, select the language you want.

INSIGNIA™

fire tv edition

A Smarter TV Is Here
HD Picture Quality, Fire TV Experience Built-in,
Voice Remote with Alexa

 **Access Your Favorite Content – All Through One Home Screen**
Fire TV Edition seamlessly integrates live over-the-air TV and streaming channels on a unified home screen

 **Endless Entertainment – Netflix, Prime Video, YouTube, Hulu, HBO, and more**
Watch over 500,000 streaming movies and TV episodes with access to tens of thousands of channels, apps, and Alexa skills

 **Control It All With Your Voice – Voice Remote with Alexa**
Use your voice to watch live TV, launch apps, search for titles, play music, switch inputs, control smart home devices, and more

Full Experience required to access all features described.

ONE-YEAR LIMITED WARRANTY
Visit www.insigniaproducts.com for details.

NEED ADDITIONAL HELP?
Check out our **Support Community** at <http://community.insigniaproducts.com/> for helpful information from other Insignia TV owners.

WE'RE HERE FOR YOU
www.insigniaproducts.com
For customer service, call: **1-877-467-4289** (U.S./Canada)

CONTACT AMAZON FIRE TV CUSTOMER SERVICE
www.amazon.com/deviceservices/support



AMAZON TERMS & POLICIES
Before using Fire TV Edition, please read the terms located at www.amazon.com/deviceservices/support. Please also read all terms and policies for services related to Fire TV Edition, including but not limited to Amazon's Privacy Notice located at www.amazon.ca/privacy, Amazon's Conditions of Use located at www.amazon.ca/conditionsofuse, and any other terms or usage provisions available at www.amazon.com/deviceservices/support. All terms, rules, notices, policies, and provisions are, collectively, the "Agreements." By using Fire TV Edition, you agree to be bound by the terms of the Agreements.

Amazon, Fire, Alexa, Prime, and all related logos are trademarks of Amazon.com, Inc. or its affiliates.

Certain services are subject to change at any time, may not be available in all areas, and may require separate subscriptions.

For DTS Patents, see <http://patents.dts.com>.
Manufactured under license from DTS, Inc. DTS, the Symbol, DTS and the Symbol together, and TruSurround are registered trademarks and/or trademarks of DTS, Inc. in the United States and/or other countries.
© DTS, Inc. All Rights Reserved.

U.S. and Canada:
INSIGNIA is a trademark of Best Buy and its affiliated companies. Registered in some countries.
Distributed by Best Buy Purchasing, LLC
7601 Penn Ave South, Richfield, MN 55423 U.S.A.

©2020 Best Buy. All rights reserved.