

USE AND CARE GUIDE

COMBINATION ELECTRIC FIREPLACE/HEATER

Model #SF105-18C

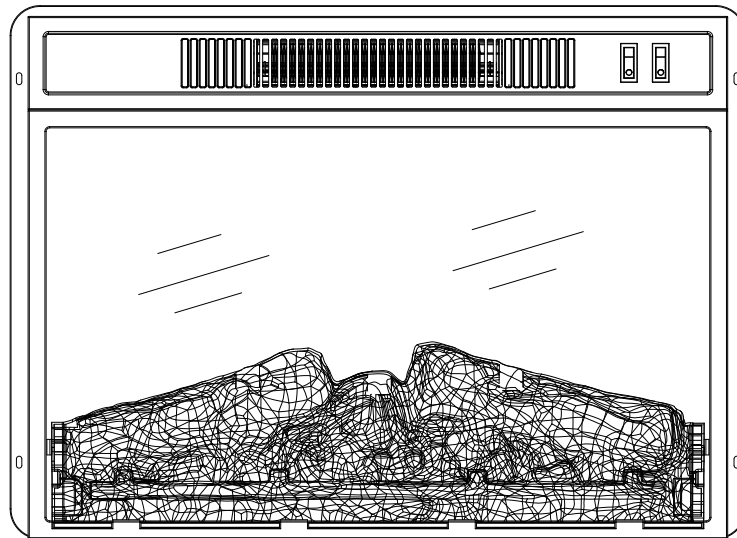

THIS INSTRUCTION BOOKLET CONTAINS **IMPORTANT** SAFETY INFORMATION.
PLEASE READ AND KEEP FOR FUTURE REFERENCE.

When using electrical appliances, basic safety precautions should always be followed including the following:

READ ALL INSTRUCTIONS BEFORE USE

1. Read all instructions before using this heater.
2. Do not use this heater outdoors.
3. This heater is not intended for use in bathrooms, laundry areas and similar indoor locations. Never locate the heater where it may fall into a bathtub or other water container.
4. Do not run the power cord under carpeting. Do not cover the power cord with throw rugs, runners, or the like. Arrange the power cord away from traffic areas and where it will not be tripped over.
5. To disconnect the heater, turn controls to off, then remove the plug from the outlet.
6. Connect to properly grounded outlet only. Always plug heaters directly into a wall outlet/receptacle. Never use with an extension cord or reloadable power tap (outlet/power strip).
7. To prevent possible fires, please do not use fireplace heaters on soft surfaces, such as beds, carpets, which may block the opening.
8. There is a thermostat limiter inside the heater. When the inner temperature overheats or abnormal heating occurs, the thermostat protective device cuts off the power supply to avoid damage to the fireplace or risk of fire.
9. Use the heater only as described in the manual. Any other use not recommended by the manufacturer may cause fire, electric shock, or injury.

⚠ WARNING: There is no user serviceable parts inside fireplace/heater. If the unit appears to malfunction, turn the unit off and unplug from the wall immediately and contact Customer Service.

 **WARNING:** This heater is hot when in use. To avoid burns, do not let bare skin touch hot surfaces. If provided, use handles when moving the heater. Keep combustible material, such as furniture, pillows, bedding, papers, clothes, and curtains at least 3ft (0.9m) from the front of the heater and keep them away from the side or rear.

 **WARNING:** Extreme caution is necessary when any heater is used by or near children or invalids and whenever the heater is left operating and unattended.

 **WARNING:** Always unplug the heater when not in use.

 **WARNING:** Do not operate any heater with a damaged cord or plug or after the heater malfunctions, has been dropped, or damaged in any manner. Return the heater to an authorized service facility for examination, electrical or mechanical adjustment, or repair.

 **WARNING:** Do not insert or allow foreign objects to enter any ventilation or exhaust openings as this may cause an electric shock or fire, or damage to the heater.

 **WARNING:** A heater has hot and arcing or sparking parts inside. Do not use in areas where gasoline, paint, or flammable liquids are used or stored.

⚠ CAUTION: While the heater is in use, the top center of the fireplace can get hot to the touch, and may cause serious injury or burns. Always supervise small children around the fireplace/heater. Do not place any cloth or decorations over the heater outlet or fireplace, or otherwise obstruct the heater outlet of the fireplace, as this may cause a fire and serious injury.

TECHNICAL SPECIFICATION

Model Number	SF105-18C
Dimensions (W x D x H)	21.1" x 6.3" x 19.7"
Net Weight	4.3kg/9.5 lb
Gross Weight	5.4kg/11.9 lb
Power Rating	1400 W
Voltage	120 V
Frequency	60 Hz

PACKAGE CONTENT



Fireplace Unit



Screw x5

ASSEMBLY INSTRUCTION

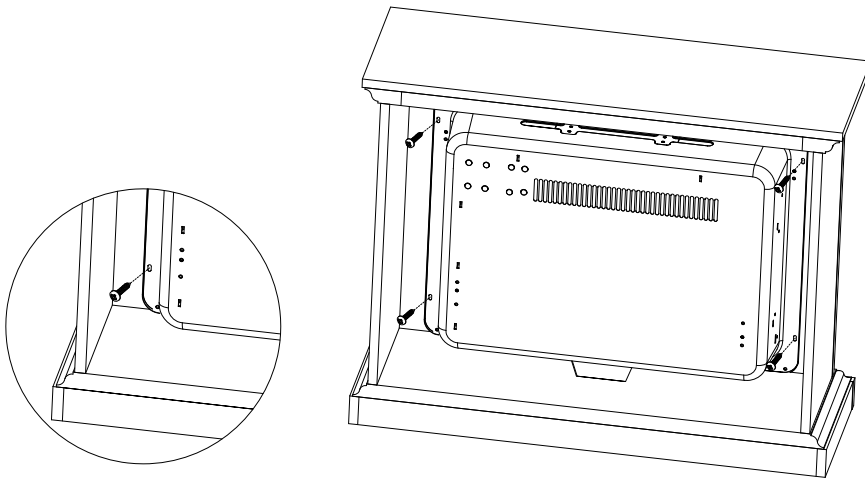

STEP 2

Take out the unit from the box and layout all the spare parts for easy assembly. Make sure all small items are not left in packaging materials.

CAUTION

- This unit has a glass front panel. Use extreme caution when handling glass to prevent personal injury or damage.

STEP 3

Carefully set the unit from the back of the mantel and center it in the opening. Check the alignment and attach the unit of the mantel by inserting screws through the drilled holes on the trim of the mantel.

NOTE: Do not attempt to install the unit from the front of the mantel. It will not fit.

USER INSTRUCTION

Before use

Check that the air intake and exhaust is not covered or obstructed in anyway.

Keep combustible objects at least 3ft away from the unit.

Plug the unit to a grounded power socket.

Grounding

This product must be grounded. If it should malfunction or breakdown, grounding provides a path of least resistance for electric current to reduce the risk of electric shock.

This unit comes standard with a 6ft (1.8m) long, three wired cord. Always plug the unit into a wall outlet. An extension or relocate tab should never be used.

CAUTION / WARNING

- Improper connection of the equipment grounding conductor can result in a risk of electric shock. Check with a qualified electrician or serviceman if you are in doubt as to whether the product is properly grounded.
- DO NOT modify the plug provided with the product nor using any bypass device if the plug does not fit the outlet. Have a proper outlet installed by a qualified electrician.

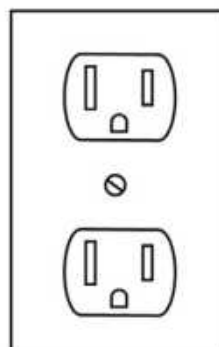

Operation

- Read all instructions and warning prior to operating the appliance.
- Ensure that all controls are in the “OFF” position before plugging the appliance in to a properly grounded electrical outlet.
- The main control panel is located behind the cover at the top right corner on the front.

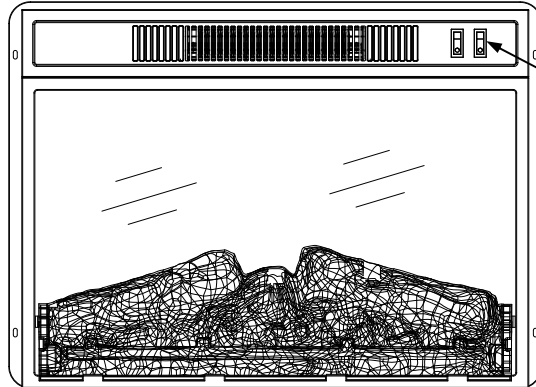

Right: Power ON / OFF
Left: Heater ON / OFF

Care and Maintenance



WARNING: Always disconnect from the power supply before cleaning the heater. First turn off the main power. Then remove the electrical plug from the wall outlet.



WARNING: Do not use this fireplace insert if any part of it has been under water. Immediately call a qualified service technician to inspect the firebox and replace any part of the electrical system which has been under water.

The blower motor and flame motor are pre-lubricated for a durable using time and need no further lubrication or maintenance. To remove any accumulation of dust or debris, the soft brush attachment of a vacuum cleaner should occasionally be used to clean the outlet grille of the fan heater.

- Use a soft, clean cloth that will not scratch the surface when dusting.
- Use a clean soft cloth dampened with warm water to clean the fireplace surface. DO NOT use household or abrasive cleaners, as these products may damage the surface.
- When cleaning the glass viewing screen use a non-abrasive damp cloth with liquid cleaner or soft soap if necessary; DO NOT use cleaning powders or any other substance with abrasives since these substances will scratch glass.
- Under no circumstances should this product be operated with a broken or chipped glass panel.
- Do not strike or slam the glass.
- In the event that your appliance is stained or otherwise damaged during use, we recommend that you call a professional to repair it.
- When not in use please unplug the cord from the outlet to prevent any damage or accidents.

Troubleshooting

Problem	Solution
The unit does not turn on.	<ul style="list-style-type: none"> □ Check that the unit is fully plugged into a standard 120 V outlet. □ Press the power button on the control panel.
The unit is on, but there is no flame effect.	<ul style="list-style-type: none"> □ Open the back panels to check if the flame spindle has fallen off from the spindle motor.
There is a visible flame effect, but the heater does not continue to blow warm air after repeatedly turning on the heater.	<ul style="list-style-type: none"> □ Turn on/off the heater button several times to make sure it is in the “ON” position.
The heater does not work, but the power and heater switches are in the “ON” position.	<ul style="list-style-type: none"> □ Turn off fireplace and unplug the unit from the wall outlet for 5 minutes. After 5 minutes plug the unit back into the wall outlet, and operate as normal. Make sure that no objects are blocking the air vents on the top and on the front of your fireplace.